



**PROJECT
TELECOM**
UNIFYING COMMUNICATIONS



Premium EX Wireless Speakerphone with Wireless Mics

USER GUIDE

What's in the box

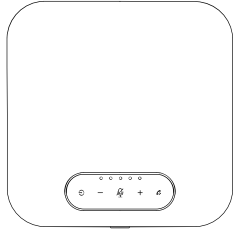

Wireless Speakerphone X 1

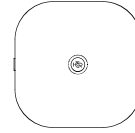

Wireless Microphone X 2



USB Cable X 1



Wireless Receiver X 1
(Optional)



User Manual X 1

Overview

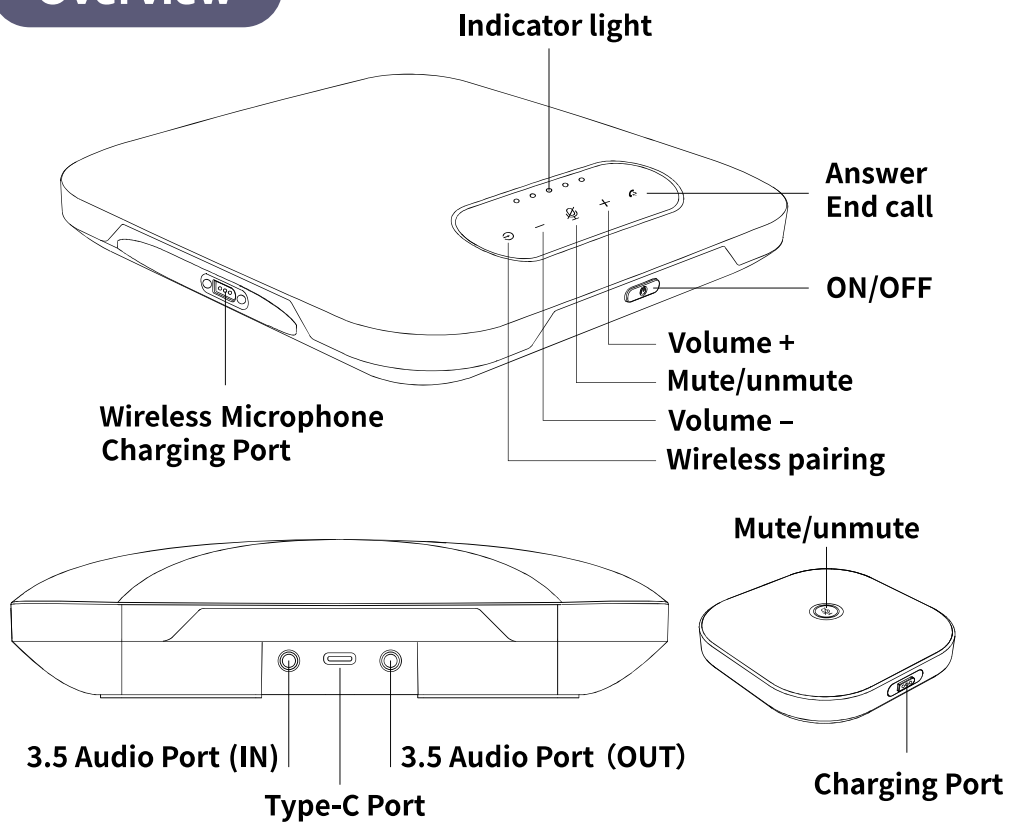

Easy Set-Up

About main speakerphone

Power On/Off

Long press ON/OFF  for 3s, the speakerphone will be turn on/off with hint tone.

Connect and disconnect

2.1 Wireless connection

- After power on, long press wireless pairing button for about 2s to start pairing mode. You will hear “pairing” (white and blue flashing light).
- Turn on your device and choose to connect with the speakerphone. Wait for 3s until you hear hint tone.
- To cancel pairing: a short click on pairing button.(flashing light turn white).
- To disconnect: a long press on pairing button for about 2s, you will hear hint tone. (Blue light turn white).

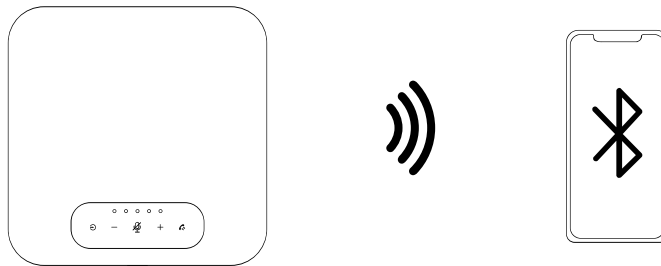

2.2 Connect by USB cable

Connect with computer by USB cable.

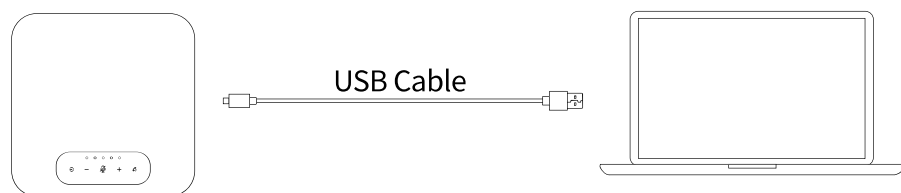

2.3 Connect by Wireless Receiver

Connect the USB wireless receiver to your computer, and start pairing mode on speakerphone. Wait for about 15 seconds until the pairing is completed, then the speakerphone is connected and ready to go.

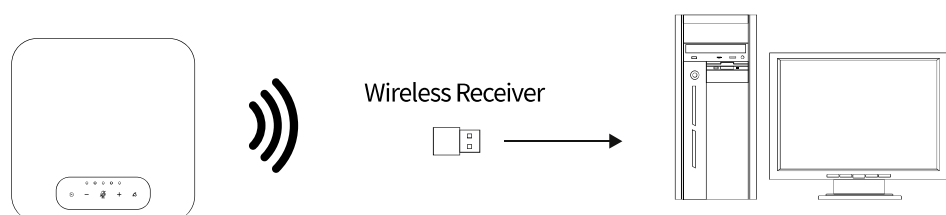

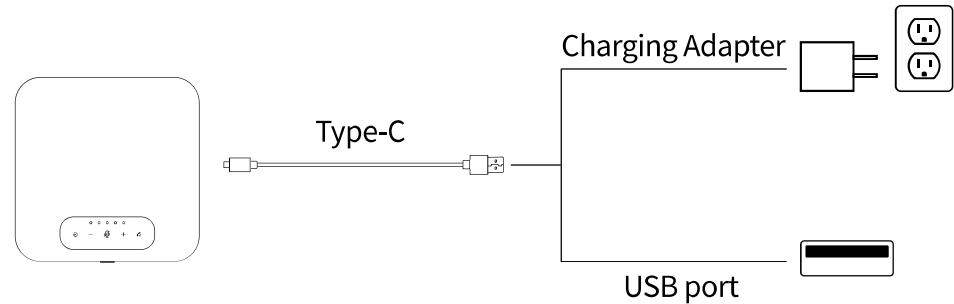

3

3. Charging





Main speakerphone: connect the speakerphone by USB to an AC adapter or USB charging port, it will start to charge.

4. Answer /end calls

Press  button to answer calls, press  button to end calls.

5. Speaker volume up/down

 Speaker volume up,  Speaker volume down

6. Mute

Press mute button  among any of the main speakerphone and wire all microphones will be muted at the same time. Press again to unmute. When microphone is working, light will be white. When muted, light will be red.

7. Automatic shut off

When device is not connected for 15mins, it will shut off automatically.

8. Battery level

When charging or short press power key, the green light is the charging/power level indicator. During charging it will be green flash light, and full green light when charging is completed.

● About wireless microphone

1. Power On/Off

Long press mute button for 3s, it will be turned on/off.



4

2. Connect and Disconnect

A. Long press mute button on the wireless mic for about 6s, the white light will flash quickly to enter the pairing mode. Then a short press on the call key+power key on the main speakerphone to start pairing.

(Note: Usually the wireless microphones should have been paired with main speakerphone already before delivery. In special cases, refer to this method to pair again if they were disconnected).

B. When wireless mic is disconnected with main speakerphone, it will be white flash light and shut down automatically after 18mins.

C. When main speakerphone is shut down, the connected wireless mics will be shut down at the same time.

3. Charging

Wireless microphone: While the main speakerphone is charging, put the wireless microphone magnetic charging connector near the speakerphone charging port. Wireless microphone will be connected and start to charge.

(Note: When battery under low level, it will be red flash light. During charging it will be green flash light, and full green light when charging is completed.)

