

DrayTek

Vigor167

35b Modem



QUICK START GUIDE

V1.1

Vigor167 35b Modem Quick Start Guide

Version: 1.1

Firmware Version: V5.1

(For future update, please visit [DrayTek web site](#))

Date: May 4, 2022

Intellectual Property Rights (IPR) Information

Copyrights

© All rights reserved. This publication contains information that is protected by copyright. No part may be reproduced, transmitted, transcribed, stored in a retrieval system, or translated into any language without written permission from the copyright holders.

Trademarks

The following trademarks are used in this document:

- Microsoft is a registered trademark of Microsoft Corp.
- Windows 8, 10 and Explorer are trademarks of Microsoft Corp.
- Apple and Mac OS are registered trademarks of Apple Inc.
- Other products may be trademarks or registered trademarks of their respective manufacturers.

Safety Instructions and Approval

Safety Instructions

- Read the installation guide thoroughly before you set up the modem.
- The modem is a complicated electronic unit that may be repaired only by authorized and qualified personnel. Do not try to open or repair the modem yourself.
- Do not place the modem in a damp or humid place, e.g. a bathroom.
- Do not stack the modems.
- The modem should be used in a sheltered area, within a temperature range of 0 to +45 Celsius.
- Do not expose the modem to direct sunlight or other heat sources. The housing and electronic components may be damaged by direct sunlight or heat sources.
- Do not deploy the cable for LAN connection outdoor to prevent electronic shock hazards.
- Keep the package out of reach of children.
- When you want to dispose of the modem, please follow local regulations on conservation of the environment.

Warranty

We warrant to the original end user (purchaser) that the modem will be free from any defects in workmanship or materials for a period of two (2) years from the date of purchase from the dealer. Please keep your purchase receipt in a safe place as it serves as proof of date of purchase. During the warranty period, and upon proof of purchase, should the product have indications of failure due to faulty workmanship and/or materials, we will, at our discretion, repair or replace the defective products or components, without charge for either parts or labor, to whatever extent we deem necessary to restore the product to proper operating condition. Any replacement will consist of a new or re-manufactured functionally equivalent product of equal value and will be offered solely at our discretion. This warranty will not apply if the product is modified, misused, tampered with, damaged by an act of God, or subjected to abnormal working conditions. The warranty does not cover the bundled or licensed software of other vendors. Defects that do not significantly affect the usability of the product will not be covered by the warranty. We reserve the right to revise the manual and online documentation and to make changes from time to time in the contents hereof without obligation to notify any person of such revision or changes.

Model: Vigor167

Power Consumption : 4.4W (Max.)

Power Input:: 12V  0.4A

Manufacturer: DrayTek Corporation

Address: No. 26, Fushing Rd, Hukou, Hsinchu Industrial Park, Hsinchu 303, Taiwan



EU Declaration of Conformity

We DrayTek Corp. , office at No.26, Fu Shing Road, HuKou County, Hsin-Chu Industry Park, Hsinchu 300, Taiwan , R.O.C., declare under our sole responsibility that the product

- **Product name:** 35b Modem
- **Model number:** Vigor167
- **Manufacturer:** DrayTek Corp.
- **Address:** No.26, Fushing Rd., Hukou, Hsinchu Industrial Park, Hsinchu 303, Taiwan
- **Importer:** SEG, 11 Capital Business Park, Borehamwood, Herts, WD6 1GW

is in conformity with the relevant Union harmonisation legislation:

EMC Directive 2014/30/EU , Low Voltage Directive 2014/35/EU , ErP 2009/125/EC and RoHS 2011/65/EU with reference to the following standards

Standard	Version / Issue date
EN 55032	2012+AC:2016 class B
EN 61000-3-2	2014 Class A
EN 61000-3-3	2013
EN 55024	2010+A1:2015
EN 62368	2014+A11:2017
EC No. 1275/2008	2008



Hsinchu

(place)

30th December, 2020

(date)

Calvin Ma / President.

(Legal Signature)



Declaration of Conformity

We DrayTek Corp. , office at No.26, Fushing Rd., Hukou, Hsinchu Industrial Park, Hsinchu 303, Taiwan, declare under our sole responsibility that the product

- **Product name:** 35b Modem
- **Model number:** Vigor167
- **Manufacturer:** DrayTek Corp.
- **Address:** No.26, Fushing Rd., Hukou, Hsinchu Industrial Park, Hsinchu 303, Taiwan
- **Importer:** SEG, 11 Capital Business Park, Borehamwood, Herts, WD6 1GW

is in conformity with the relevant UK Statutory Instruments:

The Electromagnetic Compatibility Regulations 2016 (SI 2016 No.1091), The Electrical Equipment (Safety) Regulations 2016 (SI 2016 No.1101), The Ecodesign for Energy-Related Products and Energy Information (Amendment) (EU Exit) Regulations 2019 (SI 2019 No.539) and The Restriction of the Use of Certain Hazardous Substances in Electrical and Electronic Equipment Regulations 2012 (SI 2012 No. 3032) with reference to the following standards:

Standard	Version / Issue date
EN 55032	2012+AC:2016 class B
EN 61000-3-2	2014 Class A
EN 61000-3-3	2013
EN 55024	2010+A1:2015
EN 62368	2014+A11:2017
EC No. 1275/2008	2008

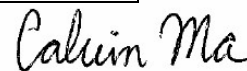

Hsinchu

(place)

30th December, 2020

(date)

Calvin Ma / President.

(Legal Signature)



Regulatory Information

This equipment has been tested and found to comply with the limits for a Class B digital device, pursuant to Part 15 of the FCC Rules. These limits are designed to provide reasonable protection against harmful interference in a residential installation. This equipment generates, uses and can radiate radio frequency energy and, if not installed and used in accordance with the instructions, may cause harmful interference to radio communications. However, there is no guarantee that interference will not occur in a particular installation. If this equipment does cause harmful interference to radio or television reception, which can be determined by turning the equipment off and on, the user is encouraged to try to correct the interference by one of the following measures:

- Reorient or relocate the receiving antenna.
- Increase the separation between the equipment and receiver.
- Connect the equipment into an outlet on a circuit different from that to which the receiver is connected.
- Consult the dealer or an experienced radio/TV technician for help.

This device complies with Part 15 of the FCC Rules. Operation is subject to the following two conditions:

- (1) This device may not cause harmful interference, and
- (2) This device may accept any interference received, including interference that may cause undesired operation.

USA Local Representative	Company name	ABP International Inc.		
	Address	13988 Diplomat Drive Suite 180 Dallas TX 75234		
	ZIP Code	75234	E-mail	rmesser@abptech.com
	Contact Person	Mr. Robert Messer	Tel.	19728311600

For more updates, please visit www.draytek.com.

*The external power supply used for each product will be model dependent.

	1	2	3	4	5	6	7	8	9
A Manufacturer	CWT	CWT	CWT	CWT	CWT	APD	APD	APD	APD
B Address	No. 222, Sec. 2, Nankan Rd., Lujhu Township, Taoyuan County 338, Taiwan	No. 222, Sec. 2, Nankan Rd., Lujhu Township, Taoyuan County 338, Taiwan	No. 222, Sec. 2, Nankan Rd., Lujhu Township, Taoyuan County 338, Taiwan	No. 222, Sec. 2, Nankan Rd., Lujhu Township, Taoyuan County 338, Taiwan	No. 222, Sec. 2, Nankan Rd., Lujhu Township, Taoyuan County 338, Taiwan	No. 5, Lane 83, Lung-Sou St., Taoyuan City 330, Taiwan	No. 5, Lane 83, Lung-Sou St., Taoyuan City 330, Taiwan	No. 5, Lane 83, Lung-Sou St., Taoyuan City 330, Taiwan	No. 5, Lane 83, Lung-Sou St., Taoyuan City 330, Taiwan
C Model identifier	2ABB012F UK 2ABB012F EU	2ABB018F UK 2ABB018F EU	2ABLO24F UK 2ABLO24F EU	2ABLO30F UK 2ABLO30F EU	2ABNO36F UK 2ABNO36F EU	WA-12M12FG WA-12M12FK	WB-18D12FG WB-18D12FK	WA-24Q12FG WA-24Q12FK	WA-36A12FG WA-36A12FK
D Input voltage	100-240V	100-240V	100-240V	100-240V	100-240V	100-240V	100-240V	100-240V	100-240V
E Input AC frequency	50/60Hz	50/60Hz	50/60Hz	50/60Hz	50/60Hz	50/60Hz	50/60Hz	50/60Hz	50/60Hz
Output voltage DC	12.0V	12.0V	12.0V	12.0V	12.0V	12.0V	12.0V	12.0V	12.0V
F Output current	1.0A	1.5A	2.0A	2.5A	3.0A	1.0A	1.5A	2.0A	3.0A
G Output power	12.0W	18.0W	24.0W	30.0W	36.0W	12.0W	18.0W	24.0W	36.0W
H Average active efficiency	84.9%	86.2%	87.6%	87.8%	89.8%	83.7%	85.4%	88.6%	88.2%
I Efficiency at low load 10%	73.6%	78.0%	81.3%	83.3%	83.7%	74.5%	80.5%	86.4%	85.4%
J No-load power consumption	0.07W	0.07W	0.07W	0.07W	0.07W	0.07W	0.10W	0.07W	0.10W

External power supply (Power Adapter) information. For more updates, please visit www.draytek.com.



Table of Contents

1. Package Content	1
2. Panel Explanation.....	2
3. Hardware Installation	3
3.1 Network Connection	3
3.2 Wall-Mounted Installation.....	4
4. Software Configuration	5
5. Customer Service	9

1. Package Content

Take a look at the package content. If there is anything missed or damaged, please contact DrayTek or dealer immediately.



Modem

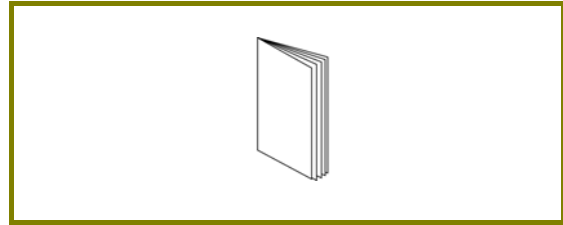

Quick Start Guide

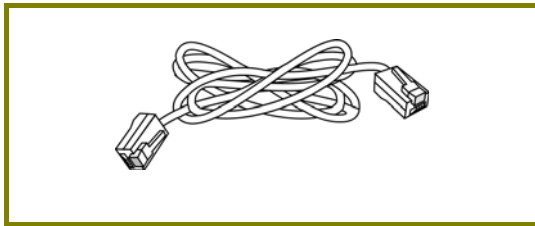

RJ-45 Cable (Ethernet)

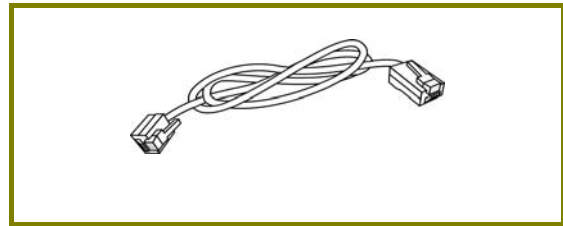

RJ-11 to RJ-11 Cable or RJ-11 to RJ-45 Cable

The type of the power adapter depends on the country that the modem will be installed. * The maximum power consumption is *4.8 Watt*.

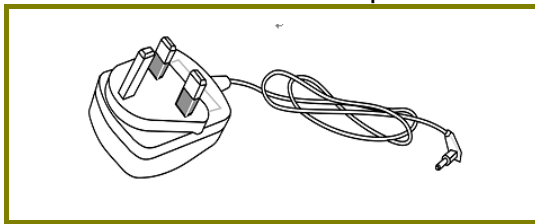

UK-type Power Adapter

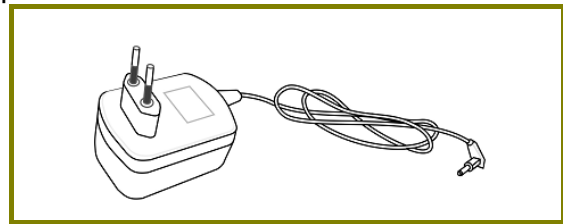

EU-type Power Adapter

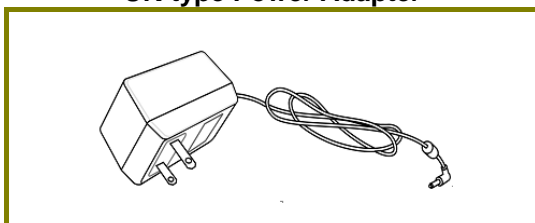

USA/Taiwan-type Power Adapter

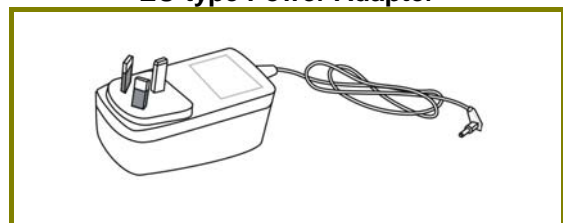

AUNZ-type Power Adapter

2. Panel Explanation

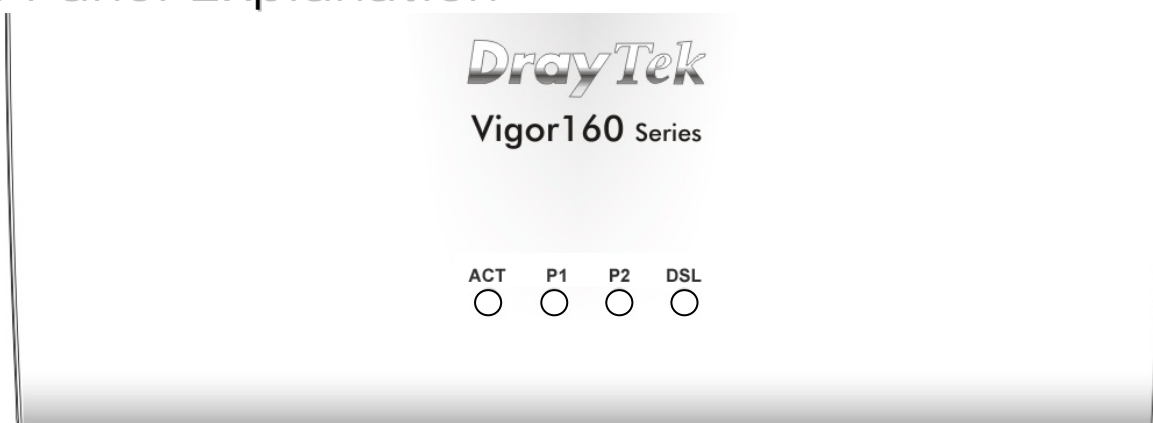

LED	Status	Explanation
ACT	Off	The system is not ready or is failed.
	Blinking	The system is ready and can work normally.
P1/P2	On	A normal connection is through its corresponding port.
	Off	LAN is disconnected.
	Blinking	Data is transmitting (sending/receiving).
DSL	On	xDSL connection synchronized.
	Blinking	xDSL connection is synchronizing.

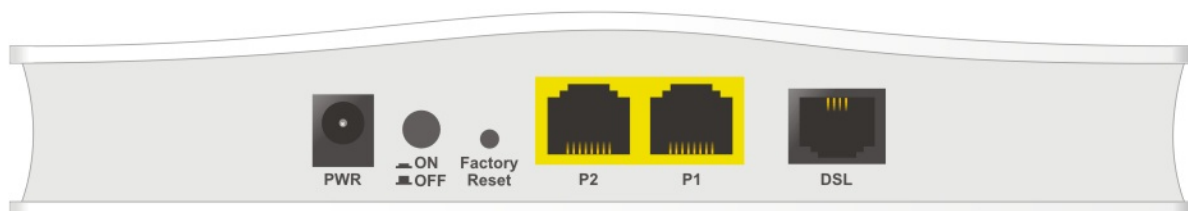

Interface	Description
PWR	Connector for a power adapter.
ON/OFF	ON/OFF: Power switch.
Factory Reset	Restore the default settings. Usage: Turn on the modem. Press the button and keep for more than 10 seconds. Then the modem will restart with the factory default configuration.
P2-P1	Connector for local networked devices.
DSL	Connector for accessing the Internet through xDSL.



Note

Remove the protective film from the router before use to ensure ventilation.

3. Hardware Installation

This section will guide you to install the modem through hardware connection and configure the modem's settings through web browser.

Before starting to configure the modem, you have to connect your devices correctly.

3.1 Network Connection

1. Connect the DSL interface to the MODEM port of external splitter with a DSL line cable.

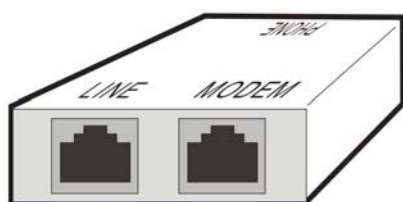

(splitter)

2. Connect the LAN port to your computer with a RJ-45 cable.
3. Connect one end of the power adapter to the Power port of this device. Connect the other end to the wall outlet of electricity.
4. Power on the modem.
5. Check the POWER, ACT, LAN, DSL and INTERNET LEDs to assure network connections.

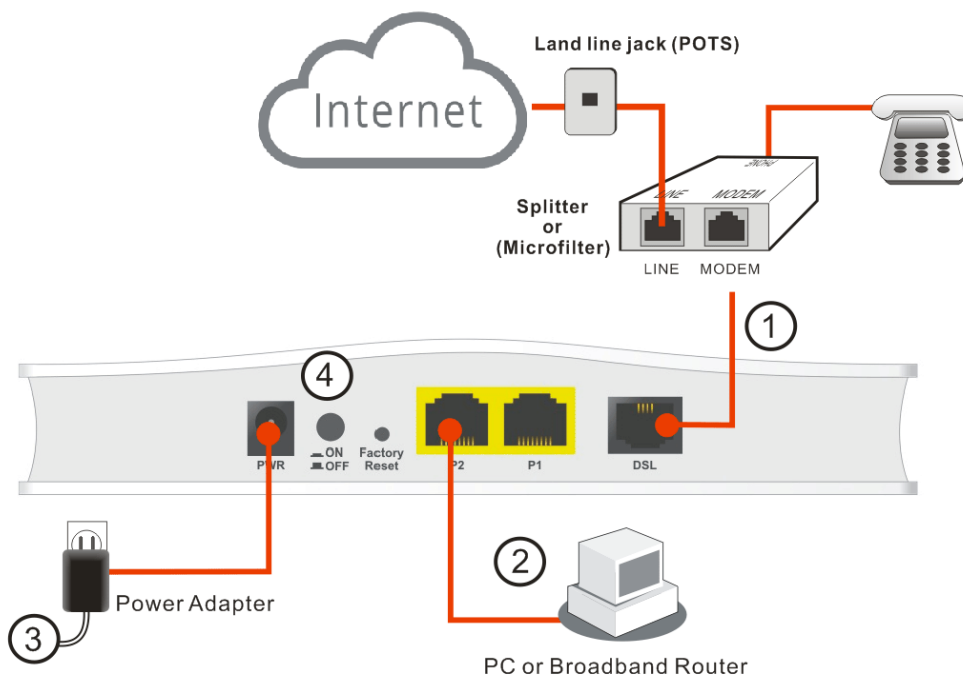

(For detailed information on LED status, please refer to section 2.)

3.2 Wall-Mounted Installation

Vigor167 has keyhole type mounting slots on the underside.

1. Drill the holes on the wall according to the recommended instruction.
2. Fit screws into the wall using the appropriate type of wall plug.

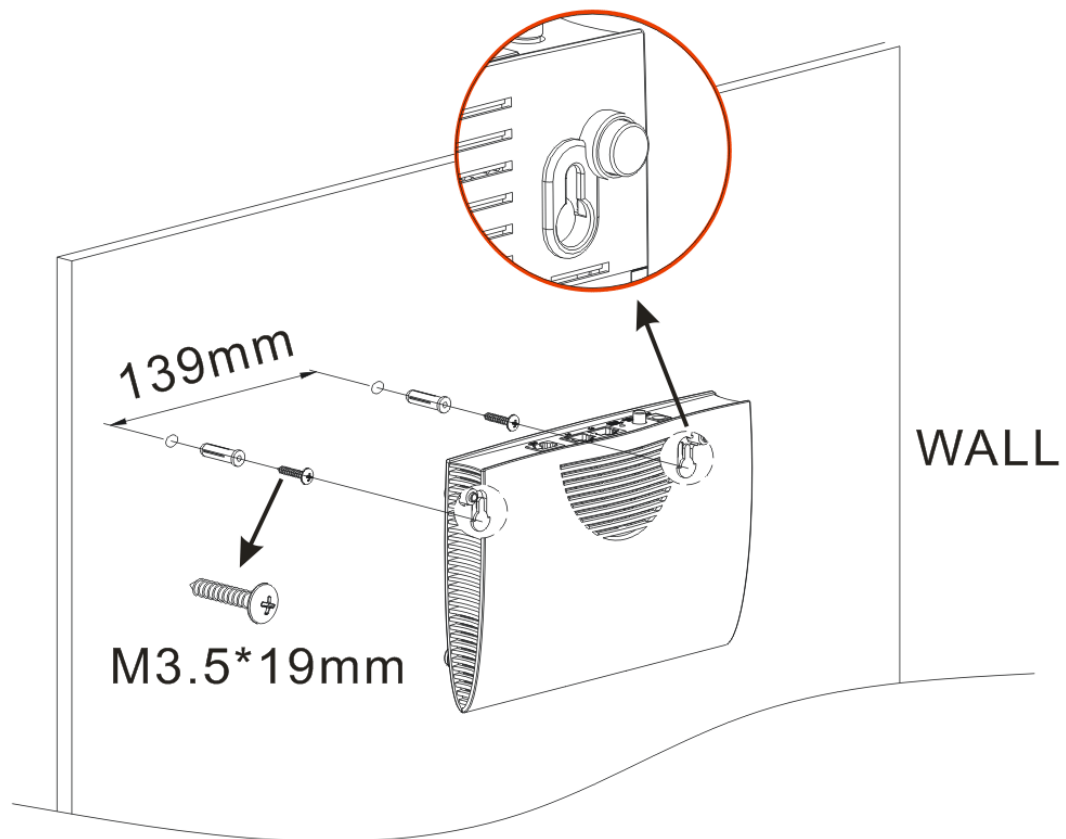

Note

The recommended drill diameter shall be 6.5mm (1/4").

3. When you finished the above procedure, the modem has been mounted on the wall firmly.

4. Software Configuration

To access the Internet, please finish the basic configuration after completing the hardware installation.

Make sure your PC connects to this device correctly.



Note

Please set up the IP address of the computer to be the same subnet as the default IP address of Vigor device **192.168.1.1**.

Open a web browser on your PC and type **http://192.168.1.1**. A pop-up window will open to ask for a username and password. Please type "admin/admin" as the Username/Password and click **Login**.

English

Username
admin

Password

DrayTek
Vigor167

Login

Now, the Main Screen will pop up.

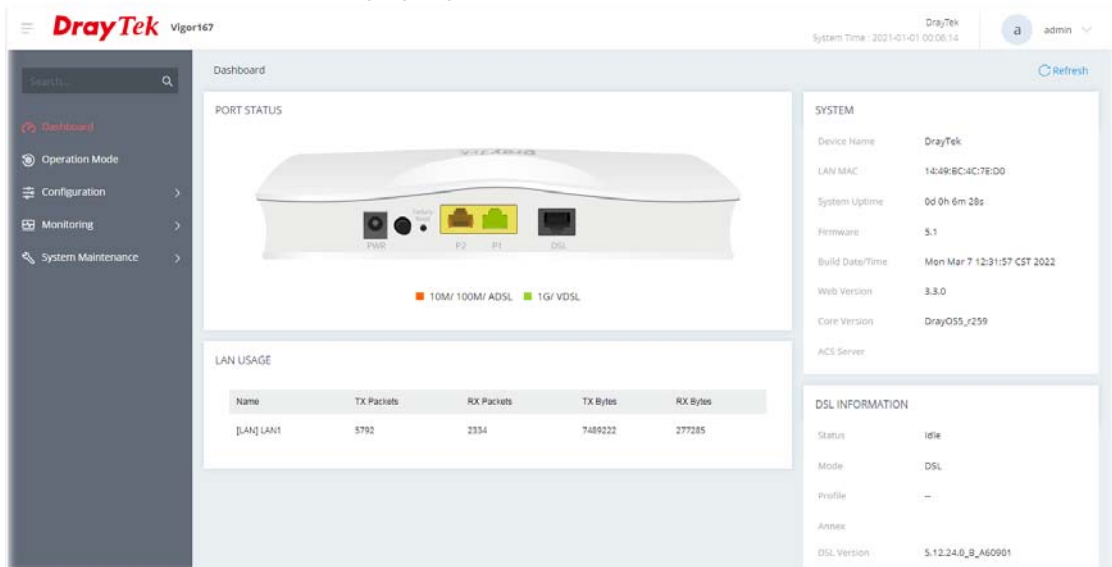

1. Open Operation Mode to open the following page. Select Modem Mode and click Next.

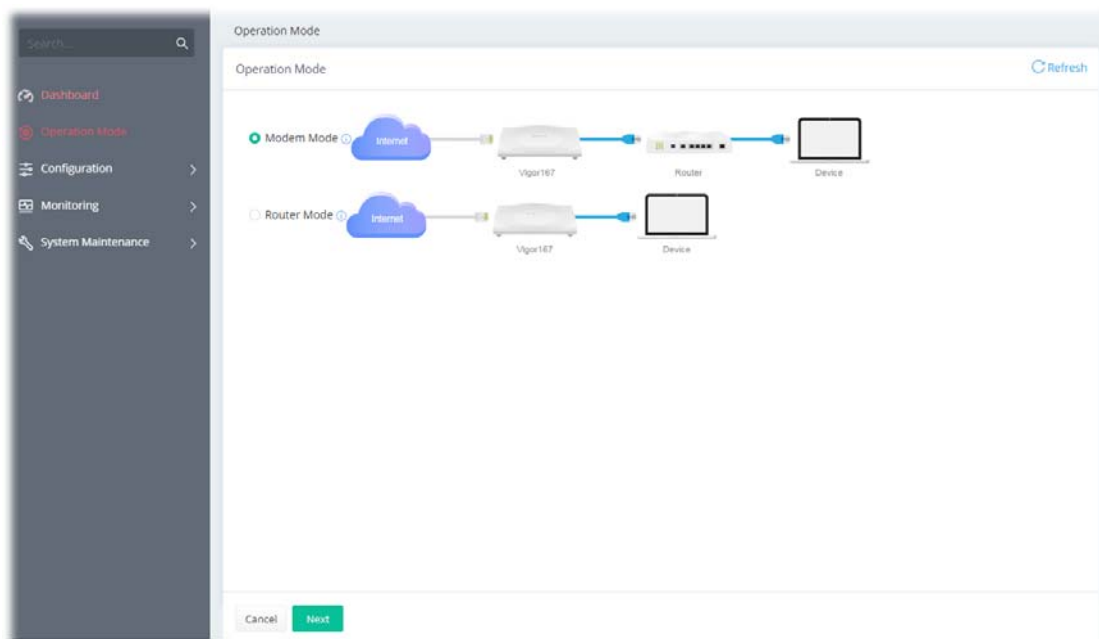

2. In this page, configure the system time settings. Then click **Next**.

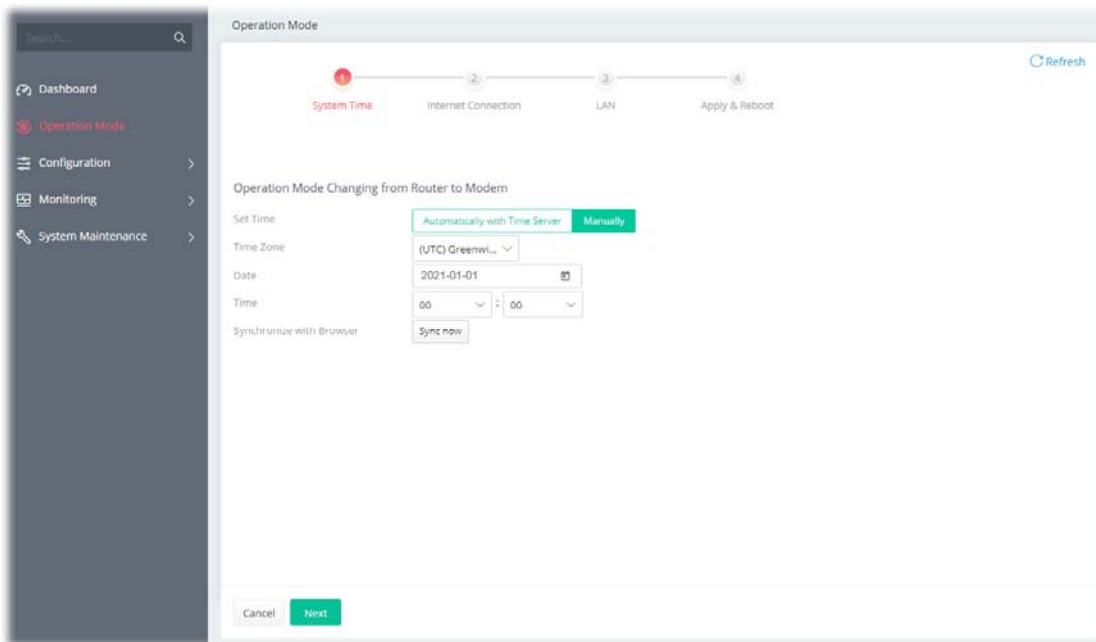

3. For the Internet connection, configure the settings based on the information from your ISP. Then click **Next** to get the next page.

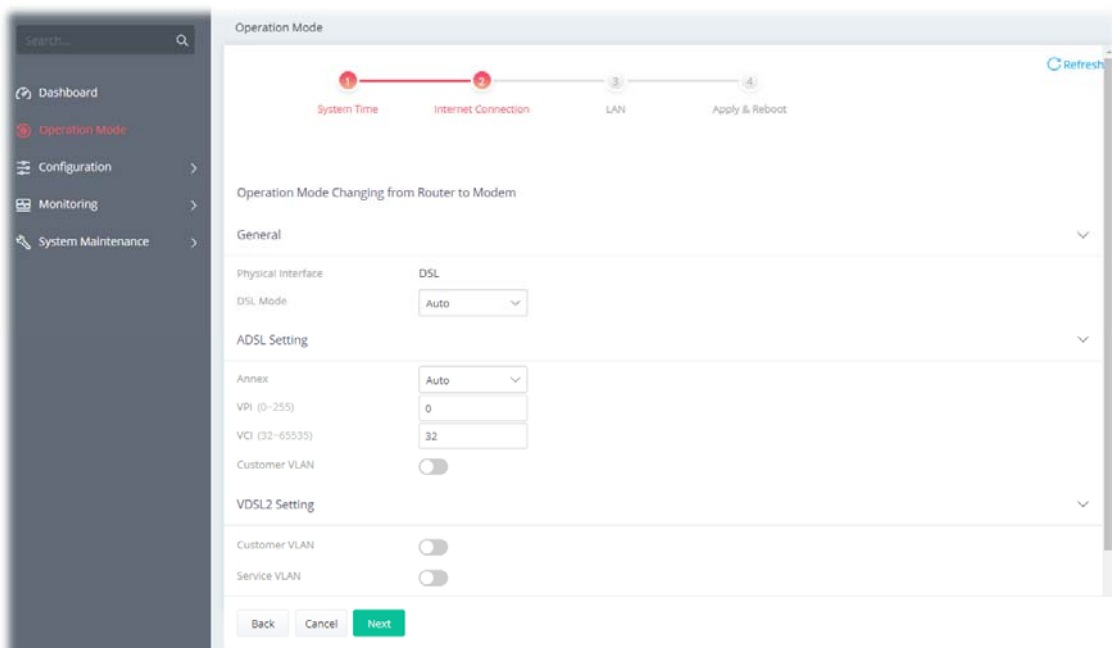

4. From the following page, change LAN settings if required. Then click Next.

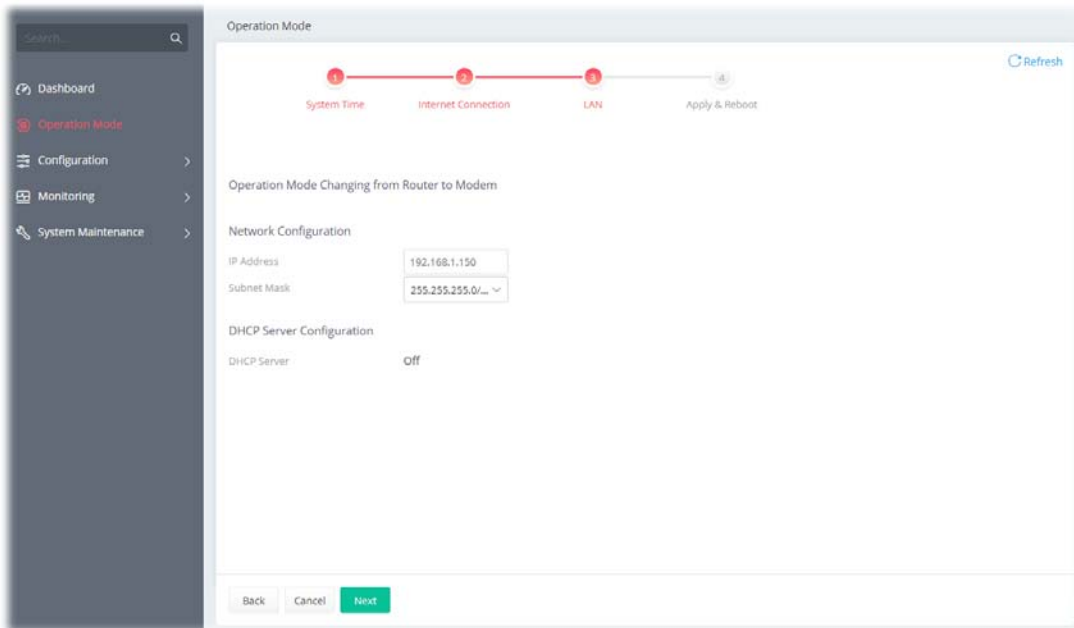

5. Now, click **Apply & Reboot** to activate the settings.

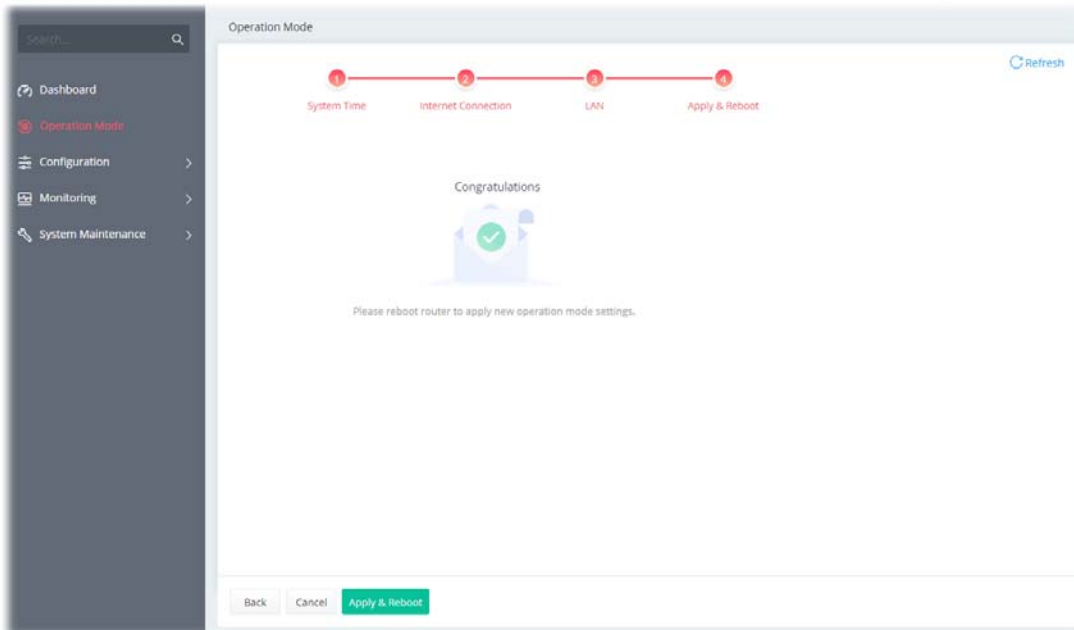

5. Customer Service

If the modem still cannot work correctly after trying many efforts, please contact your dealer for further help right away. For any questions, please feel free to send an e-mail to support@draytek.com.

Be a Registered Owner

Web registration is preferred. You can register your Vigor modem via <https://myvigor.draytek.com>.

Firmware & Tools Updates

Due to the continuous evolution of DrayTek technology, all devices will be regularly upgraded. Please consult the DrayTek website for more information on the newest firmware, tools, and documents.

<https://www.draytek.com>