



Grandstream Networks, Inc.

WP8xx Series

WP810/WP822/WP825 - User Guide



WELCOME

WP810/WP822/WP825 are Cordless Wi-Fi IP Phones featuring dual-band 802.11 a/b/g/n/ac Wi-Fi and supports Wi-Fi roaming. The combination of advanced telephony features and durability make them ideal for mobilizing your VoIP network in residences, warehouses, retail stores, hotels and many more environments. Due to a ruggedized design, these phones are safe for accidental drops and they are as well waterproof and dustproof, with large rechargeable batteries for long period of use, making them an ideal addition for homes and businesses alike.

PRODUCT OVERVIEW

Feature Highlights

The following table contain the major features of the WP810, WP822 and WP825:

Contacts	Display the list of the registered contacts and also the groups contacts with the ability of searching, adding or editing the entries and also deleting the selected contacts.
Call History	Display the call history: Missed Calls, Accepted Calls, Outgoing Calls or All Calls . You can add contacts to Shared Contacts directly from call logs.
SMS	SMS stands for Short Message Service and referred to as a "text message". With a SMS, you can send a message by pressing " New Message " of up to 160 characters to another device or check the received ones.
Voice Mail	Select: Play voice mail messages received. Note: Voicemail ID needs to be configured, otherwise, "select" softkeys will open configuration settings.
Diagnostics	<ul style="list-style-type: none">• LCD Test• LCD off• LED Test• Keypad Test• Audio Loopback• Proximity Sensor• Vibration• Verify Certificate
Settings	<ul style="list-style-type: none">• Account: Configure/View SIP accounts settings and account ringtone.• Call settings: Configure the account auto answer, call forward, DND and speed dial settings.• Network Settings: Configure the networks settings including Wi-Fi settings, and additional networks settings.• Basic Settings: Configure the basic settings including voice settings, display settings, Gestures and button customization, language settings and date/time settings.• Adv. Settings: Configure the advanced settings including system upgrade, PTT/Paging settings, system security settings, syslog settings and factory reset / reboot.

Status	<p>Displays account status, system info, Network status and network statistics</p> <ul style="list-style-type: none"> • Account status • System Info: Press to enter the sub menu for Running memory, Storage status, MAC address, System version, Recovery version, U-boot version, Kernel version, Hardware version, PN number, Country code and Running time. • Network status: Press to enter the sub menu for MAC address, IP setting information (DHCP/Static IP), IPv4 address, IPv6 address, Subnet Mask, Gateway, DNS server. • Network Statistics: Press to enter the sub menu for Network SSID, BSSID, IP address, Signal strength, Connection speed, Channel, Frequency, Tx packets, Tx error packets, Tx error rate, Tx drop packets, Tx drop rate, Rx packets, Rx error packets, Rx error rate, Rx drop packets, Rx drop rate.
---------------	--------------------------------------------------------------------------------------------------------------------------------------------------------------------------------------------------------------------------------------------------------------------------------------------------------------------------------------------------------------------------------------------------------------------------------------------------------------------------------------------------------------------------------------------------------------------------------------------------------------------------------------------------------------------------------------------------------------------------------------------------------------------------------------------------------------------------------------------------------------------------------------------------------------------

Table 1: WP810/WP822/WP825 Features at a Glance

Technical Specifications

The following table resumes all the technical specifications including the protocols/standards supported, voice codecs, telephony features, languages and upgrade/provisioning settings.

- **WP810**

Contacts	<p>Display the list of the registered contacts and also the groups contacts with the ability of searching, adding or editing the entries and also deleting the selected contacts.</p>
Call History	<p>Display the call history: Missed Calls, Accepted Calls, Outgoing Calls or All Calls. You can add contacts to Shared Contacts directly from call logs.</p>
SMS	<p>SMS stands for Short Message Service and referred to as a “text message”. With a SMS, you can send a message by pressing “New Message” of up to 160 characters to another device or check the received ones.</p>
Voice Mail	<p>Select: Play voice mail messages received.</p> <p>Note: Voicemail ID needs to be configured, otherwise, “select” softkeys will open configuration settings.</p>
Diagnostics	<ul style="list-style-type: none"> • LCD Test • LCD off • LED Test • Keypad Test • Audio Loopback • Proximity Sensor • Vibration • Verify Certificate
Settings	<ul style="list-style-type: none"> • Account: Configure/View SIP accounts settings and account ringtone. • Call settings: Configure the account auto answer, call forward, DND and speed dial settings. • Network Settings: Configure the networks settings including Wi-Fi settings, and additional networks settings. • Basic Settings: Configure the basic settings including voice settings, display settings, Gestures and button customization, language settings and date/time settings. • Adv. Settings: Configure the advanced settings including system upgrade, PTT/Paging settings, system security settings, syslog settings and factory reset / reboot.

Status	<p>Displays account status, system info, Network status and network statistics</p> <ul style="list-style-type: none"> ● Account status ● System Info: Press to enter the sub menu for Running memory, Storage status, MAC address, System version, Recovery version, U-boot version, Kernel version, Hardware version, PN number, Country code and Running time. ● Network status: Press to enter the sub menu for MAC address, IP setting information (DHCP/Static IP), IPv4 address, IPv6 address, Subnet Mask, Gateway, DNS server. ● Network Statistics: Press to enter the sub menu for Network SSID, BSSID, IP address, Signal strength, Connection speed, Channel, Frequency, Tx packets, Tx error packets, Tx error rate, Tx drop packets, Tx drop rate, Rx packets, Rx error packets, Rx error rate, Rx drop packets, Rx drop rate.
---------------	--------------------------------------------------------------------------------------------------------------------------------------------------------------------------------------------------------------------------------------------------------------------------------------------------------------------------------------------------------------------------------------------------------------------------------------------------------------------------------------------------------------------------------------------------------------------------------------------------------------------------------------------------------------------------------------------------------------------------------------------------------------------------------------------------------------------------------------------------------------------------------------------------------------------

Table 2: WP810 Technical Specifications

○ WP822

Contacts	Display the list of the registered contacts and also the groups contacts with the ability of searching, adding or editing the entries and also deleting the selected contacts.
Call History	Display the call history: Missed Calls , Accepted Calls , Outgoing Calls or All Calls . You can add contacts to Shared Contacts directly from call logs.
SMS	SMS stands for Short Message Service and referred to as a “text message”. With a SMS, you can send a message by pressing “ New Message ” of up to 160 characters to another device or check the received ones.
Voice Mail	<p>Select: Play voice mail messages received.</p> <p>Note: Voicemail ID needs to be configured, otherwise, “select” softkeys will open configuration settings.</p>
Diagnostics	<ul style="list-style-type: none"> ● LCD Test ● LCD off ● LED Test ● Keypad Test ● Audio Loopback ● Proximity Sensor ● Vibration ● Verify Certificate
Settings	<ul style="list-style-type: none"> ● Account: Configure/View SIP accounts settings and account ringtone. ● Call settings: Configure the account auto answer, call forward, DND and speed dial settings. ● Network Settings: Configure the networks settings including Wi-Fi settings, and additional networks settings. ● Basic Settings: Configure the basic settings including voice settings, display settings, Gestures and button customization, language settings and date/time settings. ● Adv. Settings: Configure the advanced settings including system upgrade, PTT/Paging settings, system security settings, syslog settings and factory reset / reboot.

<p>Status</p>	<p>Displays account status, system info, Network status and network statistics</p> <ul style="list-style-type: none"> • Account status • System Info: Press to enter the sub menu for Running memory, Storage status, MAC address, System version, Recovery version, U-boot version, Kernel version, Hardware version, PN number, Country code and Running time. • Network status: Press to enter the sub menu for MAC address, IP setting information (DHCP/Static IP), IPv4 address, IPv6 address, Subnet Mask, Gateway, DNS server. • Network Statistics: Press to enter the sub menu for Network SSID, BSSID, IP address, Signal strength, Connection speed, Channel, Frequency, Tx packets, Tx error packets, Tx error rate, Tx drop packets, Tx drop rate, Rx packets, Rx error packets, Rx error rate, Rx drop packets, Rx drop rate.
----------------------	--------------------------------------------------------------------------------------------------------------------------------------------------------------------------------------------------------------------------------------------------------------------------------------------------------------------------------------------------------------------------------------------------------------------------------------------------------------------------------------------------------------------------------------------------------------------------------------------------------------------------------------------------------------------------------------------------------------------------------------------------------------------------------------------------------------------------------------------------------------------------------------------------------------------

Table 3: *WP822 Technical Specifications*

o WP825

<p>Contacts</p>	<p>Display the list of the registered contacts and also the groups contacts with the ability of searching, adding or editing the entries and also deleting the selected contacts.</p>
<p>Call History</p> <p>SMS</p>	<p>Display the call history: Missed Calls, Accepted Calls, Outgoing Calls or All Calls. You can add contacts to Shared Contacts directly from call logs.</p> <p>SMS stands for Short Message Service and referred to as a “text message”. With a SMS, you can send a message by pressing “New Message” of up to 160 characters to another device or check the received ones.</p>
<p>Voice Mail</p> <p>Diagnostics</p>	<p>Select: Play voice mail messages received.</p> <p>Note: Voicemail ID needs to be configured, otherwise, “select” softkeys will open configuration settings.</p> <ul style="list-style-type: none"> • LCD Test • LCD off • LED Test • Keypad Test • Audio Loopback • Proximity Sensor • Vibration • Verify Certificate
<p>Settings</p>	<ul style="list-style-type: none"> • Account: Configure/View SIP accounts settings and account ringtone. • Call settings: Configure the account auto answer, call forward, DND and speed dial settings. • Network Settings: Configure the networks settings including Wi-Fi settings, and additional networks settings. • Basic Settings: Configure the basic settings including voice settings, display settings, Gestures and button customization, language settings and date/time settings. • Adv. Settings: Configure the advanced settings including system upgrade, PTT/Paging settings, system security settings, syslog settings and factory reset / reboot.

Status	<p>Displays account status, system info, Network status and network statistics</p> <ul style="list-style-type: none"> • Account status • System Info: Press to enter the sub menu for Running memory, Storage status, MAC address, System version, Recovery version, U-boot version, Kernel version, Hardware version, PN number, Country code and Running time. • Network status: Press to enter the sub menu for MAC address, IP setting information (DHCP/Static IP), IPv4 address, IPv6 address, Subnet Mask, Gateway, DNS server. • Network Statistics: Press to enter the sub menu for Network SSID, BSSID, IP address, Signal strength, Connection speed, Channel, Frequency, Tx packets, Tx error packets, Tx error rate, Tx drop packets, Tx drop rate, Rx packets, Rx error packets, Rx error rate, Rx drop packets, Rx drop rate.
---------------	--------------------------------------------------------------------------------------------------------------------------------------------------------------------------------------------------------------------------------------------------------------------------------------------------------------------------------------------------------------------------------------------------------------------------------------------------------------------------------------------------------------------------------------------------------------------------------------------------------------------------------------------------------------------------------------------------------------------------------------------------------------------------------------------------------------------------------------------------------------------------------------------------------------------

Table 4: WP825 Technical Specifications

GETTING STARTED

This chapter provides basic installation instructions including the list of the packaging contents and also information for obtaining best performance with the WP810, WP822 and WP825.

Equipment Packaging

Contacts	<p>Display the list of the registered contacts and also the groups contacts with the ability of searching, adding or editing the entries and also deleting the selected contacts.</p>
Call History	<p>Display the call history: Missed Calls, Accepted Calls, Outgoing Calls or All Calls. You can add contacts to Shared Contacts directly from call logs.</p>
SMS	<p>SMS stands for Short Message Service and referred to as a “text message”. With a SMS, you can send a message by pressing “New Message” of up to 160 characters to another device or check the received ones.</p>
Voice Mail	<p>Select: Play voice mail messages received.</p> <p>Note: Voicemail ID needs to be configured, otherwise, “select” softkeys will open configuration settings.</p>
Diagnostics	<ul style="list-style-type: none"> • LCD Test • LCD off • LED Test • Keypad Test • Audio Loopback • Proximity Sensor • Vibration • Verify Certificate
Settings	<ul style="list-style-type: none"> • Account: Configure/View SIP accounts settings and account ringtone. • Call settings: Configure the account auto answer, call forward, DND and speed dial settings. • Network Settings: Configure the networks settings including Wi-Fi settings, and additional networks settings. • Basic Settings: Configure the basic settings including voice settings, display settings, Gestures and button customization, language settings and date/time settings. • Adv. Settings: Configure the advanced settings including system upgrade, PTT/Paging settings, system security settings, syslog settings and factory reset / reboot.

<p>Status</p>	<p>Displays account status, system info, Network status and network statistics</p> <ul style="list-style-type: none"> • Account status • System Info: Press to enter the sub menu for Running memory, Storage status, MAC address, System version, Recovery version, U-boot version, Kernel version, Hardware version, PN number, Country code and Running time. • Network status: Press to enter the sub menu for MAC address, IP setting information (DHCP/Static IP), IPv4 address, IPv6 address, Subnet Mask, Gateway, DNS server. • Network Statistics: Press to enter the sub menu for Network SSID, BSSID, IP address, Signal strength, Connection speed, Channel, Frequency, Tx packets, Tx error packets, Tx error rate, Tx drop packets, Tx drop rate, Rx packets, Rx error packets, Rx error rate, Rx drop packets, Rx drop rate.
---------------	--------------------------------------------------------------------------------------------------------------------------------------------------------------------------------------------------------------------------------------------------------------------------------------------------------------------------------------------------------------------------------------------------------------------------------------------------------------------------------------------------------------------------------------------------------------------------------------------------------------------------------------------------------------------------------------------------------------------------------------------------------------------------------------------------------------------------------------------------------------------------------------------------------------------

Table 5: Equipment Packaging

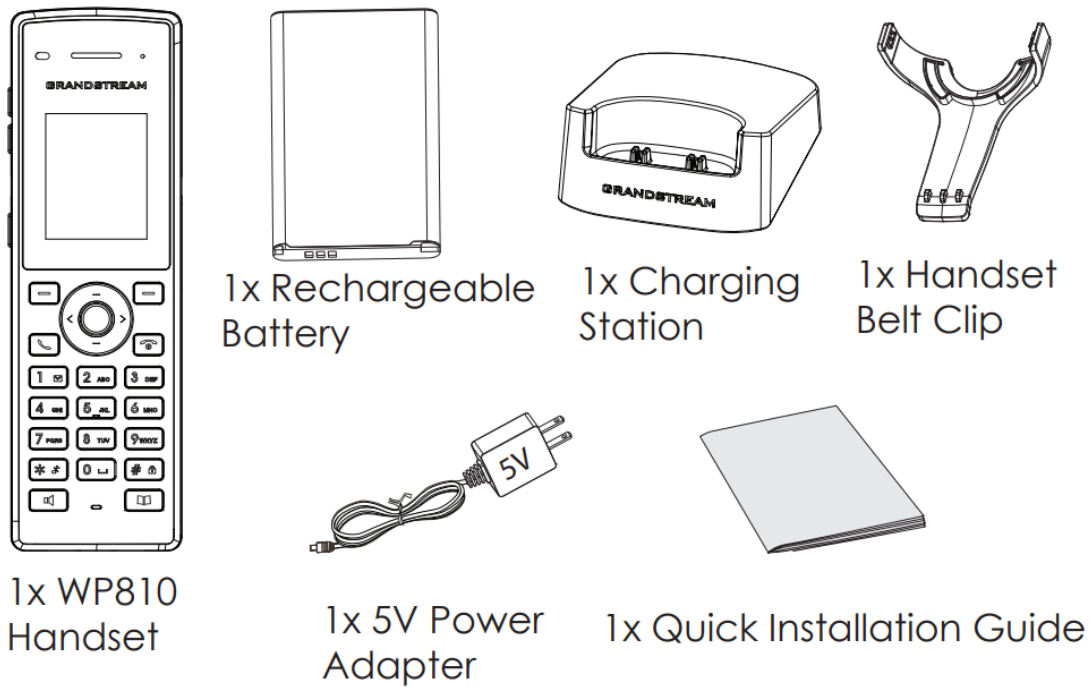
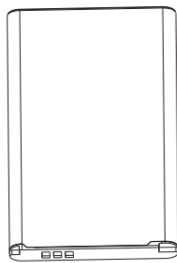

Figure 1: WP810 Package Content

- WP822



1x WP822 Handset



1x Rechargeable Battery



1x Charging Station

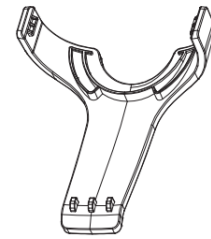

1x Handset Belt Clip



1x 5V Power Adapter

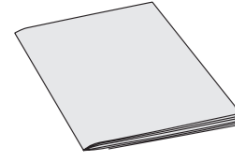

1x Quick Installation Guide

Figure 2: WP822 Package Content

o WP825



1x WP825



1x Rechargeable Battery



1x Charging Station

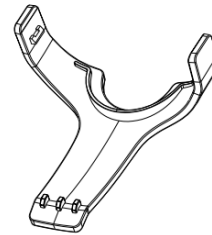

1x Handset Belt Clip



1x Quick Installation Guide

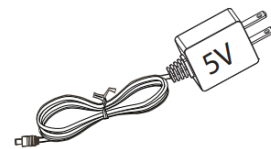

1x 5V Power Adapter

Figure 3: WP825 Package Content

Important

Check the package before installation. If you find anything missing, contact your system administrator.

Setting up the Phone

Charging Station

Plug the power adapter into a power source socket to start using the charging station.

- 1: Charging station
- 2: Power adapter

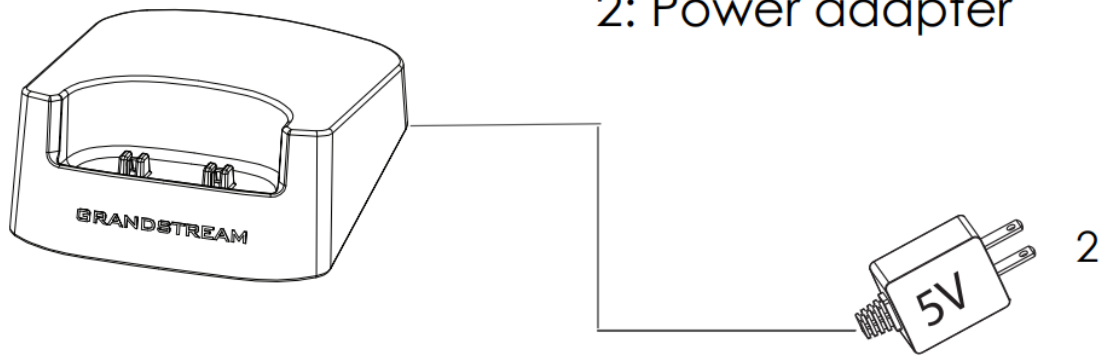

Figure 4: Charging Station

Handset

Please refer to the following steps in order to setup your WP810/WP822/WP825 phone:

1. Open the battery cover.
2. Insert the battery with the electrodes in the bottom left corner.
3. Close the battery cover.

Note

Please charge the battery fully before using the handset for the first time. (For more information about the battery, please refer to **Battery Information**.)

- 1: Battery cover
- 2: Battery
- 3: Rear of handset

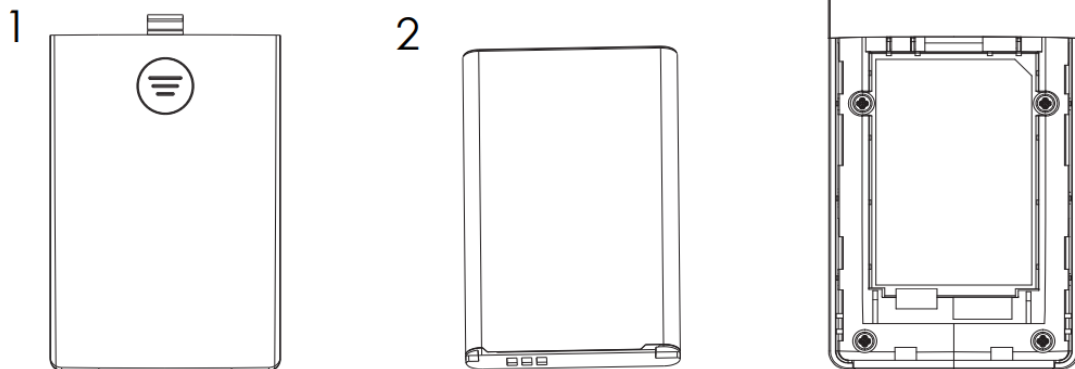

Figure 5: Handset Setup

Battery Information

WP810

- **Technology:** Rechargeable Li-ion Battery
- **Voltage:** 3.8V (Nominal Voltage 3.8V / Limited charge Voltage: 4.35V)
- **Capacity:** 1500mAh
- **Standby time:** up to 120 hours
- **Talk time:** up to 6 hours' active talk time

WP822

- **Technology:** Rechargeable Li-ion Battery
- **Voltage:** 3.8V (Nominal Voltage 3.8V / Limited charge Voltage: 4.35V)
- **Capacity:** 2000mAh
- **Standby time:** up to 200 hours
- **Talk time:** up to 8 hours' active talk time

WP825

- **Technology:** Rechargeable Li-ion Battery
- **Voltage:** 3.8V (Nominal Voltage 3.8V / Limited charge Voltage: 4.35V)
- **Capacity:** 2000mAh
- **Standby time:** up to 200 hours
- **Talk time:** up to 8 hours' active talk time

In order to get the best performance of your WP810/WP822/WP825, we recommend using original battery provided in the package. The specifications may differ depending on the age and capacity of the battery used.

Very Important

Be careful when inserting the battery into your handset to avoid any risk of short-circuit, which lead to damage your battery and/or the handset itself. Do not use damaged batteries which can increase the risk of serious harm.

Handset Keys Description

The WP810/WP822/WP825 Wireless IP phone enhances communication and combines usability and scalability in industries such as warehousing, catering and retail as well as in factory settings. The following screenshot describe the the handsets LCD screen and the main hardware components.

- **WP810**

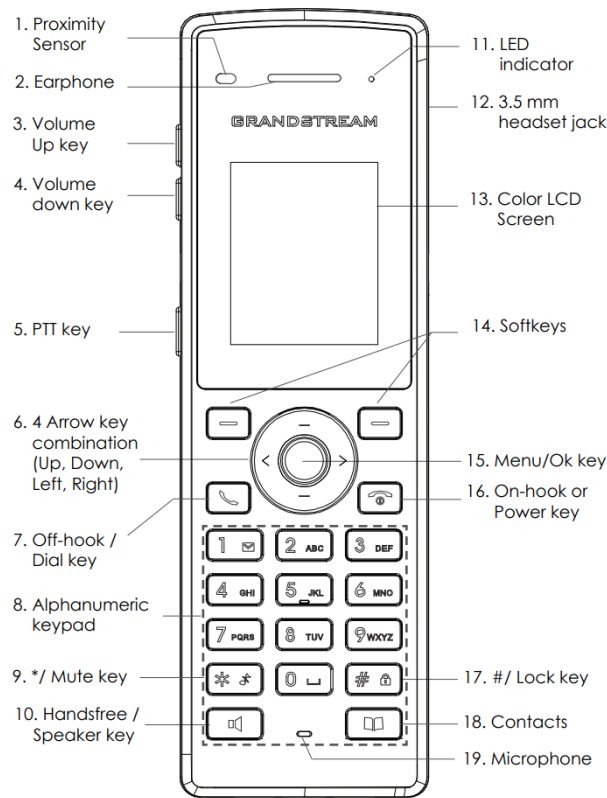

Figure 6: WP810 Description

The following table describe the WP810 keypad keys.

	Key	Description
1.	Proximity sensor	The proximity sensor can detect and measure gravitational acceleration, tilt, vibration, altitude changes, and static position.
2.	Earphone	Delivers audio output.
3,4	Volume up / Down Keys	Configure the handset and ringtone volume.
5.	PTT Key	PTT (Push-to-Talk) button, to initiate PTT call.
6.	* / Mute key	Keep pressing on * in idle screen to mute/unmute the ringtone.
7.	Arrow key combination (Up, Down, Left, Right)	Allows navigation of the cursor through the displayed menu options.
8.	Off-hook / Dial key	Enters dialing mode, or dials number entered.
9.	Alphanumeric Keypad	Provides the digits, letters, and special characters in context-sensitive applications. For + sign, press and hold key 0.
10.	Hands-free / Speaker key	Activates or deactivates the mute feature when keep pressing on * in idle screen.
11.	LED indicator	1 dual-color LED indicator indicating power, call, battery, message waiting...

12.	3.5 mm headset jack	Phone connector for the headphones/headsets.
13.	Color LCD Screen	1.8-inch (128×160) color LCD
14.	Softkeys	Correspond to functions displayed on the LCD. These functions change depending on the current context.
15.	Menu/OK key	Access to contacts list.
16.	On-hook or Power key	Selects the option chosen by the cursor or enters the main menu from the home screen.
17.	# / Lock key	Terminates calls or turns the handset on / off.
18.	Contacts	Locks keypad against unintentional entries when keep pressing #. <ul style="list-style-type: none"> ◦ Press and hold # key for approximately 2 seconds to lock the keys. ◦ Press Unlock softkey and then # to unlock the keys.
19.	Microphone	Picks up audio earpiece and hands-free calls.

Table 6: WP810 keypad keys Description

◦ WP822

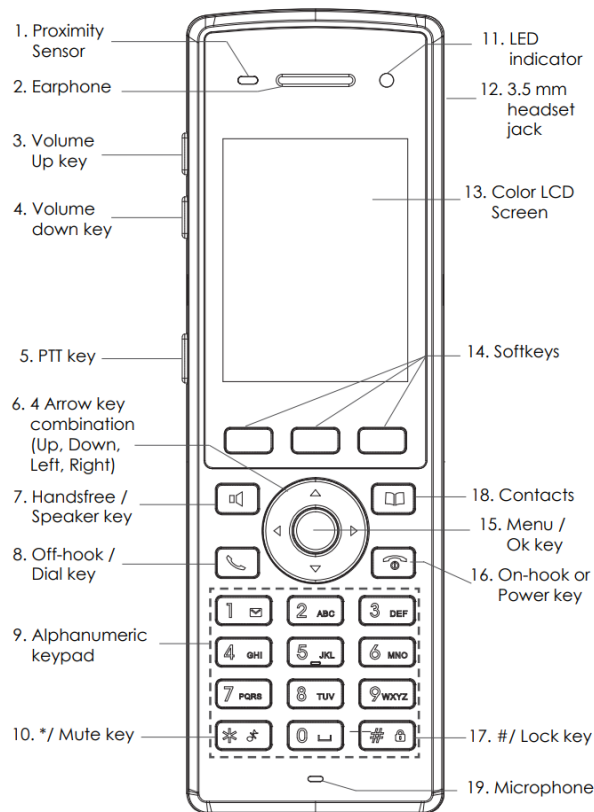

Figure 7: WP822 Description

The following table describe the WP822 keypad keys.

Key	Description

1.	Proximity sensor	The proximity sensor can detect and measure gravitational acceleration, tilt, vibration, altitude changes, and static position.
2.	Earphone	Delivers audio output.
3,4	Volume up / Down Keys	Configure the handset and ringtone volume.
5.	PTT Key	PTT (Push-to-Talk) button, to initiate PTT call.
6.	* / Mute key	Keep pressing on * in idle screen to mute/unmute the ringtone.
7.	Arrow key combination (Up, Down, Left, Right)	Allows navigation of the cursor through the displayed menu options.
8.	Off-hook / Dial key	Enters dialing mode, or dials number entered.
9.	Alphanumeric Keypad	Provides the digits, letters, and special characters in context-sensitive applications. For + sign, press and hold key 0.
10.	Hands-free / Speaker key	Activates or deactivates the mute feature when keep pressing on * in idle screen.
11.	LED indicator	1 dual-color LED indicator indicating power, call, battery, message waiting...
12.	3.5 mm headset jack	Phone connector for the headphones/headsets.
13.	Color LCD Screen	1.8-inch (128×160) color LCD
14.	Softkeys	Correspond to functions displayed on the LCD. These functions change depending on the current context.
15.	Menu/OK key	Access to contacts list.
16.	On-hook or Power key	Selects the option chosen by the cursor or enters the main menu from the home screen.
17.	# / Lock key	Terminates calls or turns the handset on / off.
18.	Contacts	Locks keypad against unintentional entries when keep pressing #. <ul style="list-style-type: none"> ◦ Press and hold # key for approximately 2 seconds to lock the keys. ◦ Press Unlock softkey and then # to unlock the keys.
19.	Microphone	Picks up audio earpiece and hands-free calls.

Table 7: WP822 keypad keys Description

- WP825

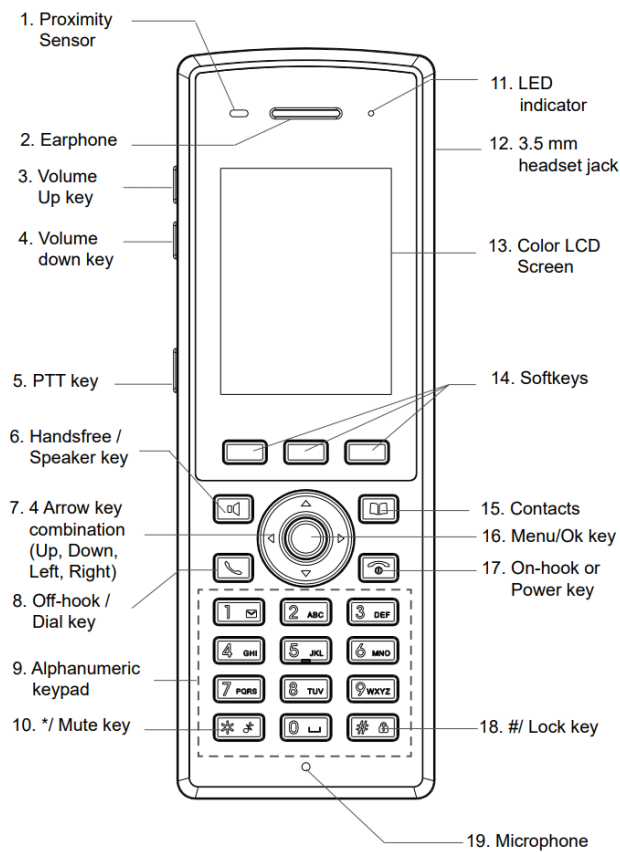

Figure 8: WP825 Description

The following table describe the WP825 keypad keys.

Key	Description
1. Proximity sensor	The proximity sensor can detect and measure gravitational acceleration, tilt, vibration, altitude changes, and static position.
2. Earphone	Delivers audio output.
3,4 Volume up / Down Keys	Configure the handset and ringtone volume.
5. PTT Key	PTT (Push-to-Talk) button, to initiate PTT call.
6. * / Mute key	Keep pressing on * in idle screen to mute/unmute the ringtone.
7. Arrow key combination (Up, Down, Left, Right)	Allows navigation of the cursor through the displayed menu options.
8. Off-hook / Dial key	Enters dialing mode, or dials number entered.
9. Alphanumeric Keypad	Provides the digits, letters, and special characters in context-sensitive applications. For + sign, press and hold key 0.
10. Hands-free / Speaker key	Activates or deactivates the mute feature when keep pressing on * in idle screen.
11. LED indicator	1 dual-color LED indicator indicating power, call, battery, message waiting...

12.	3.5 mm headset jack	Phone connector for the headphones/headsets.
13.	Color LCD Screen	1.8-inch (128×160) color LCD
14.	Softkeys	Correspond to functions displayed on the LCD. These functions change depending on the current context.
15.	Menu/OK key	Access to contacts list.
16.	On-hook or Power key	Selects the option chosen by the cursor or enters the main menu from the home screen.
17.	# / Lock key	Terminates calls or turns the handset on / off.
18.	Contacts	<p>Locks keypad against unintentional entries when keep pressing #.</p> <ul style="list-style-type: none"> ◦ Press and hold # key for approximately 2 seconds to lock the keys. ◦ Press Unlock softkey and then # to unlock the keys.
19.	Microphone	Picks up audio earpiece and hands-free calls.

Table 8: WP825 keypad keys Description

Icons Description

Following table contains description of each icon that might be displayed on the screen of the WP810/WP822/WP825.

Contacts	Display the list of the registered contacts and also the groups contacts with the ability of searching, adding or editing the entries and also deleting the selected contacts.
Call History	Display the call history: Missed Calls , Accepted Calls , Outgoing Calls or All Calls . You can add contacts to Shared Contacts directly from call logs.
SMS	SMS stands for Short Message Service and referred to as a “text message”. With a SMS, you can send a message by pressing “ New Message ” of up to 160 characters to another device or check the received ones.
Voice Mail	<p>Select: Play voice mail messages received.</p> <p>Note: Voicemail ID needs to be configured, otherwise, “select” softkeys will open configuration settings.</p>
Diagnostics	<ul style="list-style-type: none"> • LCD Test • LCD off • LED Test • Keypad Test • Audio Loopback • Proximity Sensor • Vibration • Verify Certificate

Settings	<ul style="list-style-type: none"> ● Account: Configure/View SIP accounts settings and account ringtone. ● Call settings: Configure the account auto answer, call forward, DND and speed dial settings. ● Network Settings: Configure the networks settings including Wi-Fi settings, and additional networks settings. ● Basic Settings: Configure the basic settings including voice settings, display settings, Gestures and button customization, language settings and date/time settings. ● Adv. Settings: Configure the advanced settings including system upgrade, PTT/Paging settings, system security settings, syslog settings and factory reset / reboot.
Status	<p>Displays account status, system info, Network status and network statistics</p> <ul style="list-style-type: none"> ● Account status ● System Info: Press to enter the sub menu for Running memory, Storage status, MAC address, System version, Recovery version, U-boot version, Kernel version, Hardware version, PN number, Country code and Running time. ● Network status: Press to enter the sub menu for MAC address, IP setting information (DHCP/Static IP), IPv4 address, IPv6 address, Subnet Mask, Gateway, DNS server. ● Network Statistics: Press to enter the sub menu for Network SSID, BSSID, IP address, Signal strength, Connection speed, Channel, Frequency, Tx packets, Tx error packets, Tx error rate, Tx drop packets, Tx drop rate, Rx packets, Rx error packets, Rx error rate, Rx drop packets, Rx drop rate.

Table 9: Icons Description

Note

SRTP & TLS enabled icon will be displayed only in case signaling and media are both encrypted.

LED Status

Red Fast Flashing	<ul style="list-style-type: none"> ○ Upgrading
Green Slow Flashing	<ul style="list-style-type: none"> ○ Incoming call
Green Blinking	<ul style="list-style-type: none"> ○ Charging but not full
Green Solid	<ul style="list-style-type: none"> ○ Charging (full)
Red Slow Flashing	<ul style="list-style-type: none"> ○ Missed call (s) ○ New voicemail (s) ○ New SIP Message (s)
Red Solid	<ul style="list-style-type: none"> ○ Network disconnected
LED OFF	<ul style="list-style-type: none"> ○ Normal

Table 10: LED Status

Handset Menu

The handset has an easy-to-use menu structure. Every menu opens a list of options. To open the main menu, unlock first the handset and press “Menu” (softkey in the middle). Press Arrow keys to navigate to the menu option you require. Then press “Select” (left softkey) or **OK/Selection key** to access further options or confirm the setting displayed. To go to the previous menu item, press “Back” (right softkey). You can press **Power** key at any time to cancel and return to standby mode.

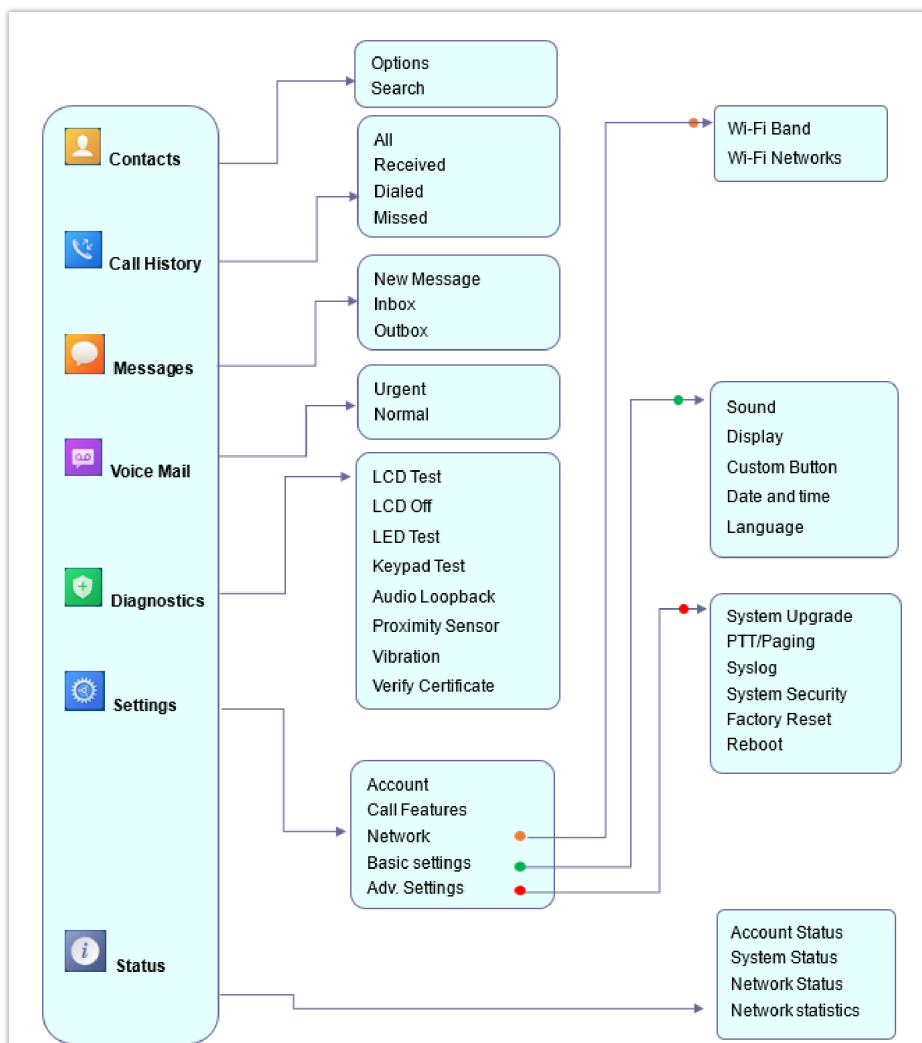

Figure 9: Menu Structure

<p>Contacts</p>	<p>Display the list of the registered contacts and also the groups contacts with the ability of searching, adding or editing the entries and also deleting the selected contacts.</p>
<p>Call History</p>	<p>Display the call history: Missed Calls, Accepted Calls, Outgoing Calls or All Calls. You can add contacts to Shared Contacts directly from call logs.</p>
<p>SMS</p> <p>Voice Mail</p>	<p>SMS stands for Short Message Service and referred to as a “text message”. With a SMS, you can send a message by pressing “New Message” of up to 160 characters to another device or check the received ones.</p> <p>Select: Play voice mail messages received.</p> <p>Note: Voicemail ID needs to be configured, otherwise, “select” softkeys will open configuration settings.</p>

Diagnostics	<ul style="list-style-type: none"> • LCD Test • LCD off • LED Test • Keypad Test • Audio Loopback • Proximity Sensor • Vibration • Verify Certificate
Settings	<ul style="list-style-type: none"> • Account: Configure/View SIP accounts settings and account ringtone. • Call settings: Configure the account auto answer, call forward, DND and speed dial settings. • Network Settings: Configure the networks settings including Wi-Fi settings, and additional networks settings. • Basic Settings: Configure the basic settings including voice settings, display settings, Gestures and button customization, language settings and date/time settings. • Adv. Settings: Configure the advanced settings including system upgrade, PTT/Paging settings, system security settings, syslog settings and factory reset / reboot.
Status	<p>Displays account status, system info, Network status and network statistics</p> <ul style="list-style-type: none"> • Account status • System Info: Press to enter the sub menu for Running memory, Storage status, MAC address, System version, Recovery version, U-boot version, Kernel version, Hardware version, PN number, Country code and Running time. • Network status: Press to enter the sub menu for MAC address, IP setting information (DHCP/Static IP), IPv4 address, IPv6 address, Subnet Mask, Gateway, DNS server. • Network Statistics: Press to enter the sub menu for Network SSID, BSSID, IP address, Signal strength, Connection speed, Channel, Frequency, Tx packets, Tx error packets, Tx error rate, Tx drop packets, Tx drop rate, Rx packets, Rx error packets, Rx error rate, Rx drop packets, Rx drop rate.

Table 11: Handset Menu

Keypad

The WP810/WP822/WP825 keypad can be used by tapping on an input field. The keypad has 4 modes “Ab3”, “ABC”, “abc” and “123”. Default mode is “Ab3”.

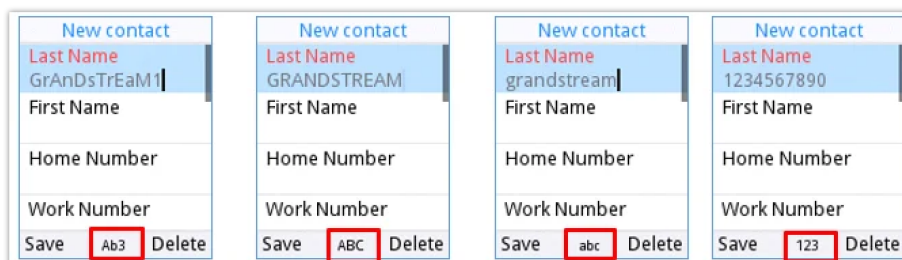

Figure 10: Keypad Modes

- “Ab3” Mode:

This mode allows to enter capital letters, small letters, digits and symbolic characters.

Following table describes allowed characters for each key.

Key	Description	Key	Description	Key	Description
1	.,'?!"-1	2	ABCabc2	3	DEFdef3
4	GHIghi4	5	JKLjkl5	6	MNOmno6
7	PQRSpqrs7	8	TUVtuv8	9	WXYZwxyz9
*	.,'?!"-()@/:_ ;+%*=<>\$[]{}~^# `&	0	Space	#	Switch mode

Table 12: "Ab3" Mode

◦ "ABC" Mode:

This mode allows to enter capital letters, digits and symbolic characters.

Following table describes allowed characters for each key.

Key	Description	Key	Description	Key	Description
1	.,'?!"-1	2	ABC2	3	DEF3
4	GHI4	5	JKL5	6	MNO6
7	PQRS7	8	TUV8	9	WXYZ9
*	.,'?!"-()@/:_ ;+%*=<>\$[]{}~^# `&	0	Space	#	Switch mode

Table 13: "ABC" Mode

◦ "abc" Mode:

This mode allows to enter small letters, digits and symbolic characters.

Following table describes allowed characters for each key.

Key	Description	Key	Description	Key	Description
1	.,'?!"-1	2	abc2	3	def3
4	ghi4	5	jkl5	6	mno6
7	pqrs7	8	tuv8	9	wxyz9
*	.,'?!"-()@/:_ ;+%*=<>\$[]{}~^# `&	0	Space	#	Switch mode

Table 14: "abc" Mode

◦ "123" Mode:

This mode allows to enter digits only.

Following table describes allowed characters for each key.

Key	Description	Key	Description	Key	Description
1	1	2	2	3	3
4	4	5	5	6	6
7	7	8	8	9	9
*	.	0	0	#	Switch mode

Table 15: "123" Mode

Tips using the keypad:

- To switch between the modes, users could press the # key.
- Press multiple times on same key to move forward between the allowed characters.
- Use Right/Left arrow keys to change the cursor's position on the text entered.
- For languages that support letters with accents, the handset now supports typing letters with accents on modes "AB3", "abc", and "ABC".

WEB GUI ACCESS CONFIGURATION

The WP810/WP822/WP825 can be configured using:

- Web GUI embedded on the handset using PC's web browser.
- LCD Configuration Menu using the WP810/WP822/WP825 keypad.

Note

From the Web GUI, you can configure all the functions supported by the WP810/WP822/WP825; while via keypad menu, you can access limited configuration.

Configuration via Web Browser

The WP810/WP822/WP825 embedded Web server responds to HTTP/HTTPS GET/POST requests. Embedded HTML pages allow a user to configure the handset through a Web browser such as Google Chrome, Mozilla Firefox.

Note

Please note that Microsoft's IE 9 and below are not supported, also the records from the web cannot be played with IE10, Edge and Safari. We highly recommend using Google Chrome or Mozilla Firefox.

Accessing the Web UI

1. Connect the computer to the same network as WP810/WP822/WP825.
2. Make sure the handset is booted up and powered correctly.

3. You may check the IP address on the phone LCD menu **Status** → **Network Status**. Please see [Obtain WP810/WP822/WP825 IP Address](#)
4. Open Web browser on your computer and enter the WP810/WP822/WP825 IP address in the address bar of the browser.
5. Enter the administrator's username and password to access the Web Configuration Menu.

Note

- The computer must be connected to the same sub-network as the phone. This can be easily done by connecting the computer to the same hub or switch as the phone.
- The default administrator username is "admin", and the random password can be found on the sticker at the back of the unit. the default end-user username is "user" and the password is "123".
- If '**Web Access**' parameter is set to "Disabled" under **Advanced settings** → **System security**; web UI access will be disabled.

Web GUI Languages

Users can select the language in web GUI login page, or at the upper right of the web GUI after logging in.

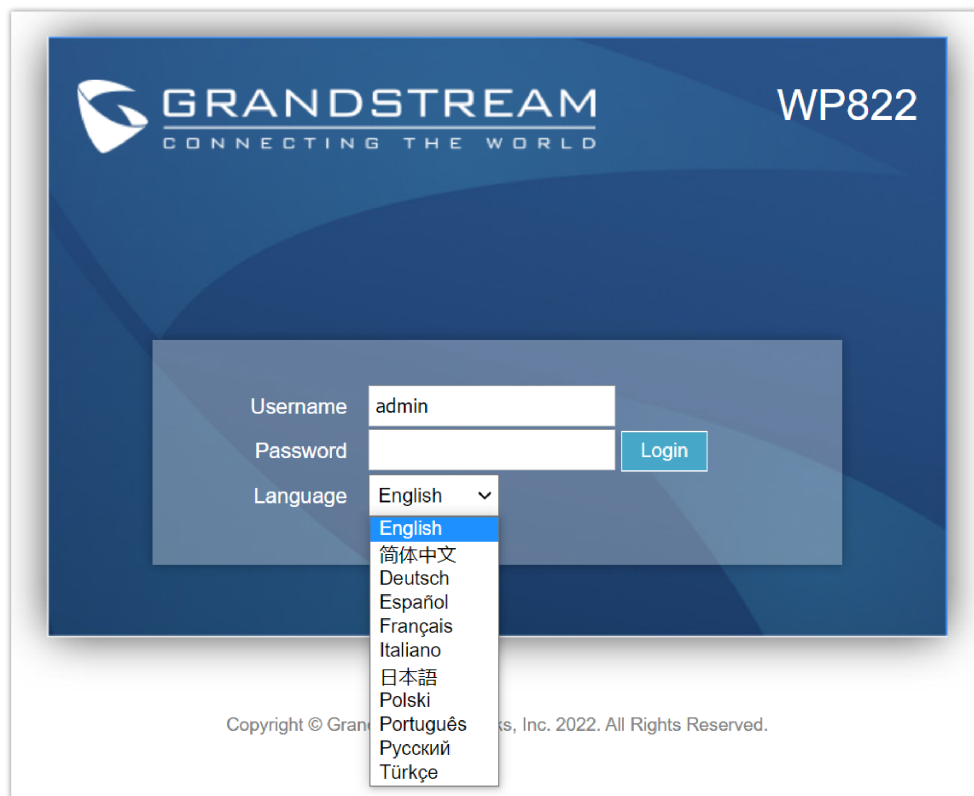

Figure 11: Web GUI Language login page

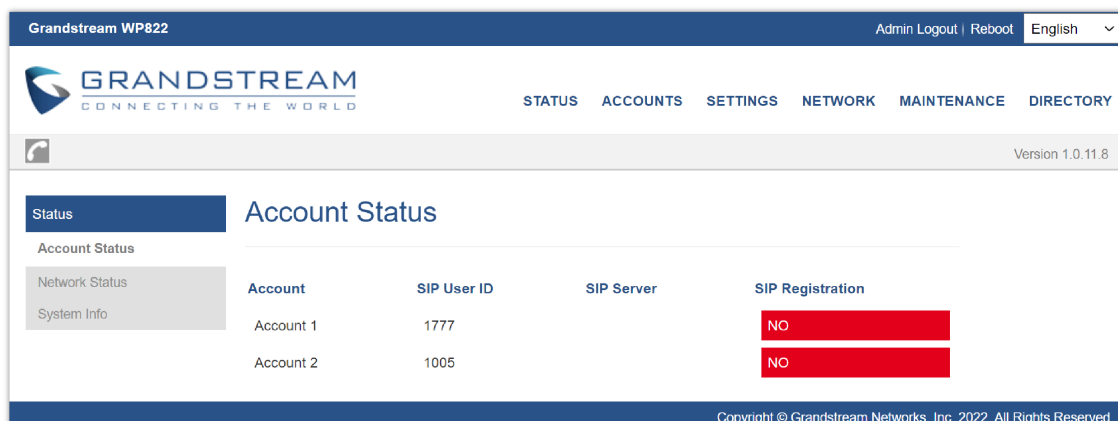

Figure 12: Web GUI Language

Saving the Configuration Changes

When changing any settings, always submit them by pressing **Save** and **Apply** buttons. If using the **Save** button, after making all the changes, click on the **Apply** button on top of the page to submit.

Web UI Access Level Management

There are two default passwords for the login page:

User Level	User Name	Password	Web Pages Allowed
End User Level	user	123	Only Status, Phone Settings, System Settings, Maintenance and System Application with limited options.
Administrator Level	admin	Random password available on the sticker at the back of the unit.	All pages

Table 16: Web UI Access Level

Changing User Level Password

1. Access the Web GUI of your phone using the admin's username and password.
2. Press **Login** to access your settings.
3. Go to **Maintenance** → **Web Access**.
4. locate **User Password** section:
 - Type in your new user password in **New Password** field.
 - Type in again same entered password in **Confirm Password** field.
5. Press **Save** button to save your new settings.

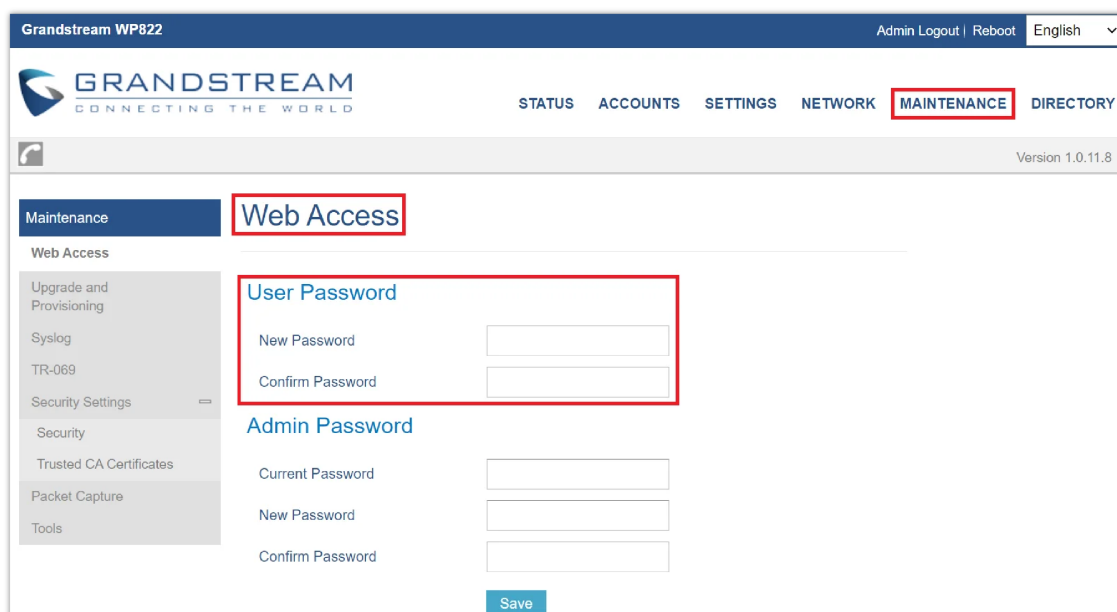

Figure 13: Changing User Level Password

Note

- DO NOT USE same password for both user and admin accounts.
- The password is case sensitive with maximum length of 25 characters

Changing Admin Level Password

1. Access the Web GUI of your WP810/WP822/WP825 using the admin's username and password. (Default username and password is admin/Random Password from the sticker on the back of the unit).
2. Press **Login** to access your settings.
3. Go to **Maintenance** → **Web Access**.
4. locate **Admin Password** section:
 1. Type in the admin password in the **Current Password** field
 2. Type in your new admin password in **New Password** field.
 3. Type in again same entered password in **Confirm Password** field.
5. Press **Save** button to save your new settings.

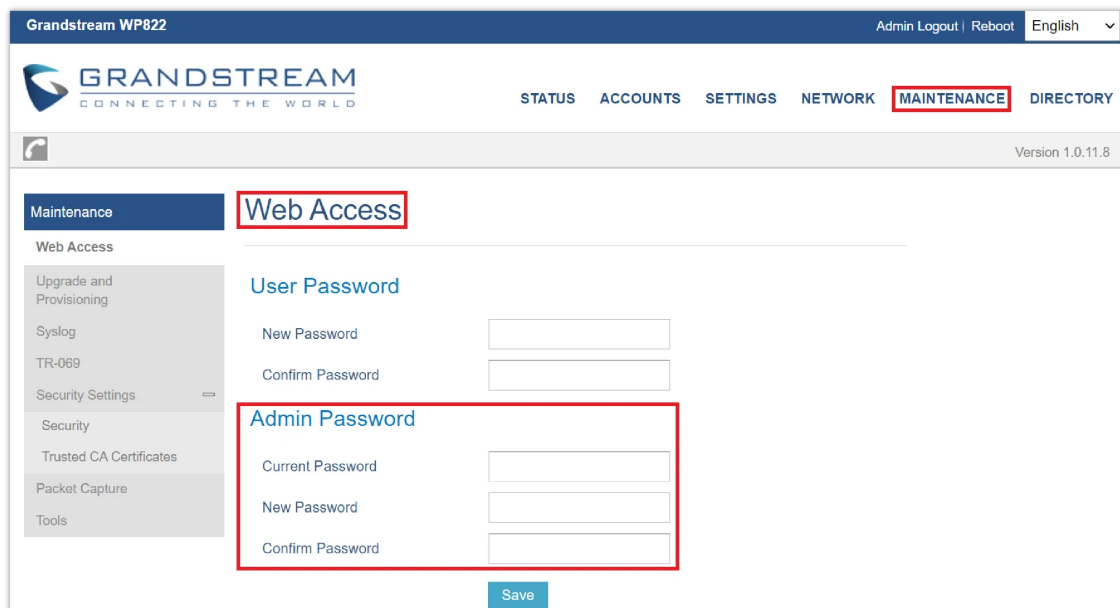

The screenshot displays the Grandstream WP822 Web GUI. At the top, there is a navigation bar with 'Grandstream WP822' on the left and 'Admin Logout | Reboot | English' on the right. Below this is a main menu with 'STATUS', 'ACCOUNTS', 'SETTINGS', 'NETWORK', 'MAINTENANCE', and 'DIRECTORY'. The 'MAINTENANCE' tab is selected and highlighted with a red box. Under 'MAINTENANCE', there is a sub-menu with 'Web Access' highlighted with a red box. The 'Web Access' section contains two main areas: 'User Password' and 'Admin Password'. The 'Admin Password' section is highlighted with a red box and contains three input fields: 'Current Password', 'New Password', and 'Confirm Password'. A 'Save' button is located at the bottom of the 'Admin Password' section. The version number 'Version 1.0.11.8' is visible in the bottom right corner.

Figure 14: Admin Level Password

Important

- DO NOT USE same password for both user and admin accounts.
- The password is case sensitive with maximum length of 25 characters.

Changing HTTP/HTTPS Web Access Port

1. Access the Web GUI of your handset using the admin's username and password. (Default username and password are admin/Random password from the sticker on the back of the unit.).
2. Press **Login** to access your settings.

3. Go to **Maintenance** → **Security Settings** → **Security**
4. In **Web Access Mode**, select the access method depending on desired protocol (HTTP or HTTPS or Both)
5. Locate **HTTP / HTTPS Web Port** field and change it to your desired/new HTTP / HTTPS port.
Note: By default, the HTTP port is 80 and HTTPS is 443.
6. Press **Save** button to save your new settings.

Note

After modifying the connection method or port, the web GUI will be automatically logged out and redirected to the new address.

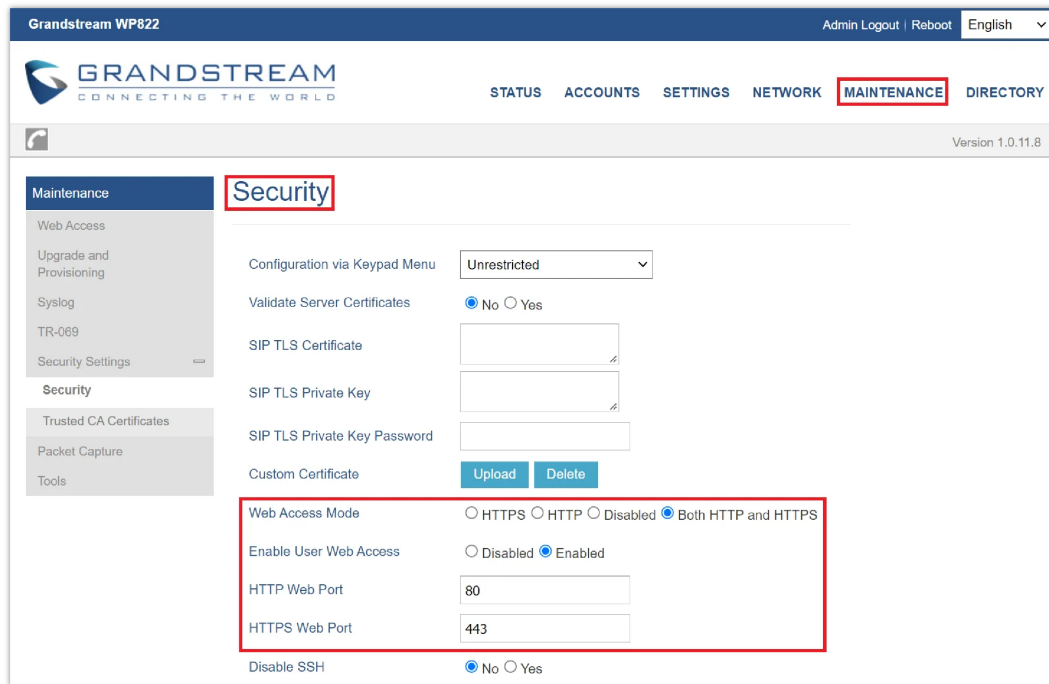

Figure 15: Web Access Port

BASIC OPERATIONS

Home Screen

The Home screen comprises three pages that make it easy for the customer to access some settings, parameters or notifications. *Please refer to the following screenshots:*

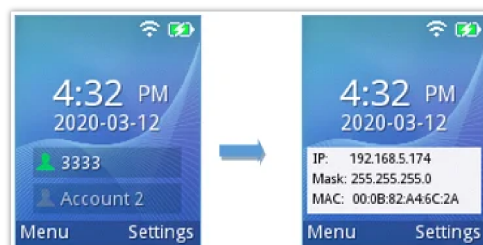



Figure 16: Home screen pages

Home Screen Page:

- This page lists the SIP account status, for example on the screenshot above account 3333 is registered.
- Users can press the UP key to display the IP address and MAC information of the handset.

Turning the Handset ON/OFF

To turn ON the handset: Long press on **Power key**  until the LCD screen lights up.

To turn OFF the handset: Long press on **Power key**  again when the handset is idle and press the softkey to choose to power off or reboot.

Connecting to Wi-Fi Network

Auto Connection

Go under the web interface of the “**Network → Wi-Fi Settings**”.

For example, the user can pre-configure the WP to automatically connect to the Wi-Fi network at the client site, making it easier for the client to use the phone without going through the setting up manually the Wi-Fi network. Also, the client could have the SSID hidden by default, and the handset would still be able to connect to the Wi-Fi network since they have SSID and password information configured. Up to 10 SSIDs are supported.

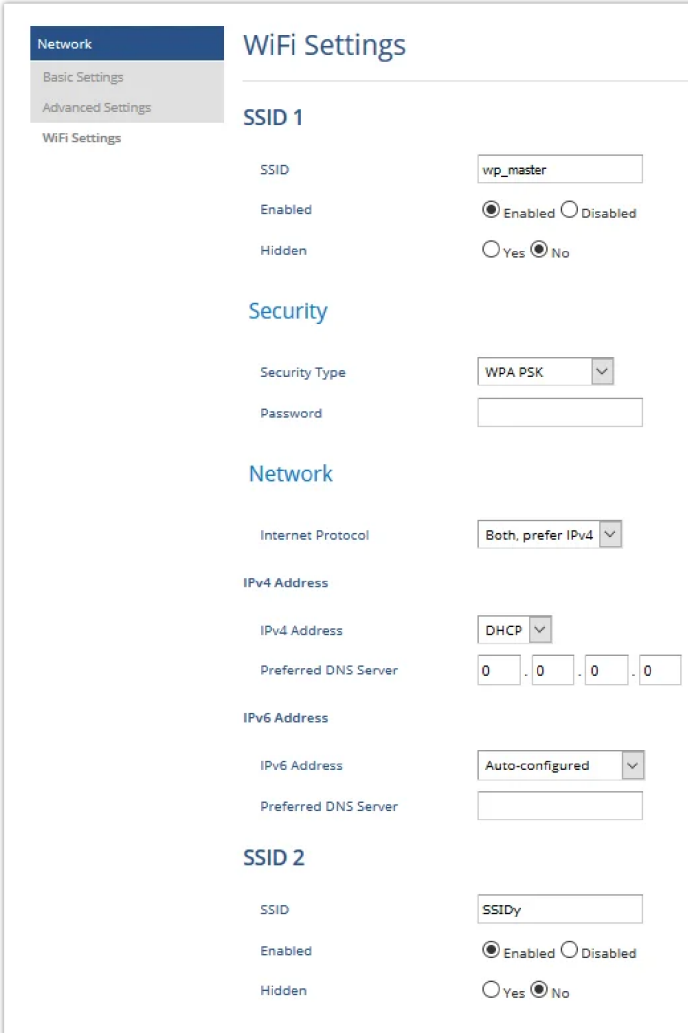

The screenshot shows the 'WiFi Settings' web interface. On the left, a navigation menu includes 'Network', 'Basic Settings', 'Advanced Settings', and 'WiFi Settings'. The main content area is titled 'WiFi Settings' and is divided into sections for 'SSID 1', 'Security', 'Network', and 'SSID 2'. Under 'SSID 1', there are fields for SSID (wp_master), Enabled (radio button selected), and Hidden (radio button selected for No). The 'Security' section includes Security Type (WPA PSK) and Password. The 'Network' section includes Internet Protocol (Both, prefer IPv4), IPv4 Address (DHCP), and IPv6 Address (Auto-configured). 'SSID 2' has fields for SSID (SSIDy), Enabled (radio button selected), and Hidden (radio button selected for No).

Figure 17: Default Wi-Fi Network

Manual connection

The WP810/WP822/WP825 support dual-band 802.11a/b/g/n/ac Wi-Fi, please refer to the following steps in order to connect to the Wi-Fi networks:

1. On LCD menu, press Menu key and navigate to **Settings → Network**.

2. Navigate to **"Wi-Fi Networks"**. A list of Wi-Fi networks will be displayed.
3. Select the desired network to connect to. (Enter the correct password to connect if requested)

The handset will display Wi-Fi icon on the main LCD menu if the connection to the Wi-Fi network is successful.

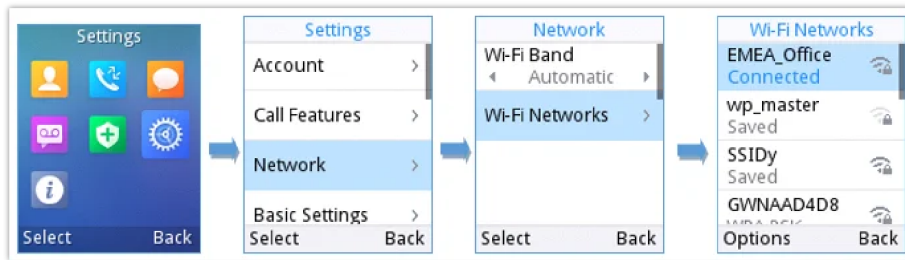

Figure 18: Connecting to Wi-Fi Network

Note

WP810/WP822/WP825 supports connection to Wi-Fi with captive portal enabled that requires additional credentials to sign up or login before it is allowed to use Wi-Fi.

Wi-Fi Band Configuration

If 5GHz and 2.4GHz are both available, the handset will use 5GHz, but it may switch to 2.4GHz if the signal of 5GHz is poor. Users may also specify the Wi-Fi Band in order to fix it or to keep it Dual Band (Automatic) under **Settings → Network → Wi-Fi Band**.

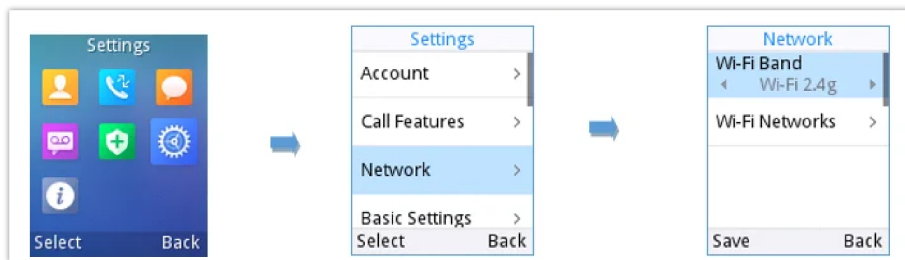

Figure 19: Wi-Fi Band Configuration

Note

Wi-Fi will restart after changing Wi-Fi band.

Checking Status

Account Status

To check the SIP accounts status, follow these steps:

1. Press **Menu** key to bring up operation menu.
2. Use arrow keys to Reach **Status** menu and navigate to **Account status**.

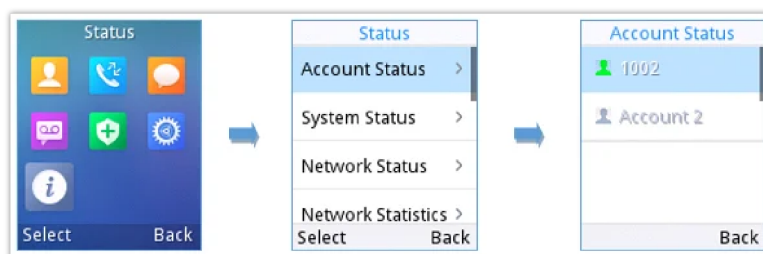

Figure 20: Account Status

The following information will be displayed:

Item	Description
Account 1	Displays the information about the first account including name, number and the status of its registration.
Account 2	Displays the information about the second account including name, number and the status of its registration.

Table 17: Account Status Description

Network Status

To check the handset network information status, follow these steps:

1. Press **Menu** key to bring up operation menu.
2. Use arrow keys to reach **Status** menu and navigate to **Network Status**.

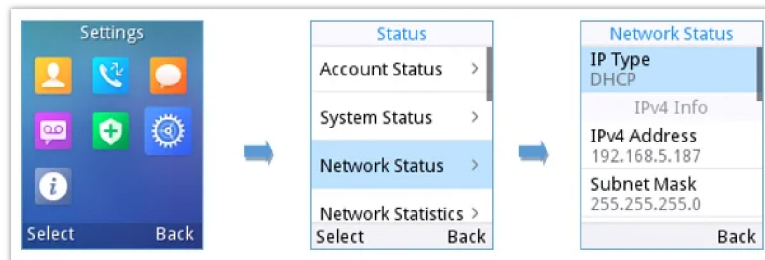

Figure 21: Network Status

Setting	Description
IPv4 Info	
IPv4 Address Type	Displays the IPv4 address type.
IPv4 Address	Displays the IPv4 address.
Subnet mask	Displays the subnet mask address.
Default router	Displays the IPv4 address of the router.
Primary DNS	Displays the IPv4 address of the primary DNS Server.
Alternate DNS	Displays the IPv4 address of the secondary DNS Server.
IPv6 Info	
IPv6 Address Type	Displays the IPv6 address type.
IPv6 Address 1	Displays the IPv6 address.

Primary DNS	Displays the IPv6 address of the primary DNS Server.
Alternate DNS	Displays the IPv6 address of the secondary DNS Server.
Other Info	
MAC address	Displays the handset's MAC address.

Table 18: Network Status Description

System Info

To check the system info, follow these steps:

1. Press **Menu** key to bring up operation menu
2. Use arrow keys to reach **Status** menu and navigate to **System Status** section.

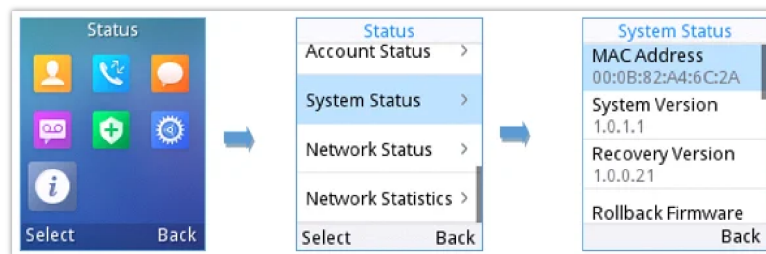

Figure 22: System Status

The following information will be displayed:

Setting	Description
MAC Address	Displays the MAC Address of the phone.
System Version	Displays the current firmware version installed.
Recovery Version	Displays the recovery version installed.
Rollback Firmware	Click to roll back the firmware to the "Recovery Version" firmware.
U-boot Version	Displays the u-boot version installed.
Kernel Version	Displays the kernel version installed.
Hardware Version	Displays the hardware version installed.
PN Number	Displays the Part Number.
Country code	Displays the country code.
Running Time	Displays the time during which the handset is powered on and working.

Network Statistics

To check the handset network information status, follow these steps:

1. Press **Menu** key to bring up operation menu.
2. Use arrow keys to reach **Status** menu and navigate to **Network Statistics**.

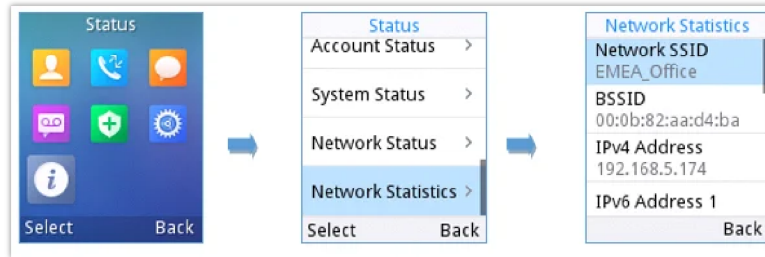

Figure 23: Network Statistics

The following information will be displayed:

Setting	Description
Network SSID	Displays the SSID Name on which the handset is connected.
BSSID	Displays the MAC address of the Access Point on which the handset is connected.
IPv4 Address	Displays the IP address of the handset.
IPv6 Address 1	Displays the IPv6 address.
Signal strength	Displays the Wi-Fi signal strength.
Connections Speed	Displays the link speed (Mbps)
Channel	Displays the channel used.
Frequency	Displays the channel frequency.
Other Information	Tx/Rx Packets, Tx/Rx Error Packets, Tx/Rx Error Rate, Tx/Rx Drop Packets and Tx/Rx Drop Rate.

Table 20: Network Statistics

Configuring the LCD Brightness and Screen Timeout

1. Press **Menu** to bring up operation menu.
2. Use arrow keys to reach **Settings**.
3. Navigate to **Basic Settings**, and then select **Display**.
4. Configures the LCD brightness, key backlight, lock screen, screen time out and the font size.
5. Press "**Back**" (right softkey) to save and apply the new settings.

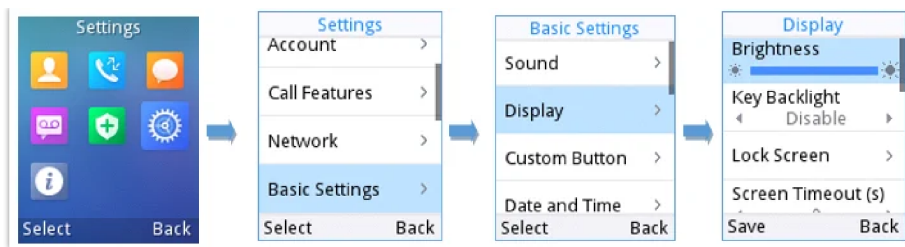



Figure 24: LCD Display Configuration

Return to Idle Screen

Press the **Power Key**  to quickly exit the menu and return back to the main idle screen.

When you are navigating on the handset's menu, and you receive an incoming call, the LCD screen will automatically exit the menu and you can either accept or reject the call, when the call is terminated, the LCD screen will return back to the idle screen.

Register a SIP Account

The WP810/WP822/WP825 supports up to 2 SIP accounts and they can be configured either using the web GUI or via the keypad menu as described on the following section.

Register Account via Web User Interface

1. Access your handset base station web UI by entering its IP address in your favorite browser.
2. Enter your admin's username and password (default username and password: admin/ Random Password from the sticker on the back of the unit).
3. Press **Login** to access your settings.
4. Go to **Account** tab and select the account to configure.
5. In **General Settings**, set the following:
 - **Account Active** to **Yes**.
 - **Account Name**: Any name to identify this specific user.
 - **SIP Server** field with your SIP server IP address or FQDN.
 - **Secondary SIP Server** with your secondary SIP server IP address or FQDN. Leave empty if not available.
 - **SIP User ID**: User account information, provided by VoIP service provider (ITSP). Usually in the form of digit similar to phone number or actually a phone number.
 - **Authenticate ID**: SIP service subscriber authenticate ID used for authentication. Can be identical to or different from SIP User ID.
 - **Authenticate Password**: SIP service subscriber's account password to register to SIP server of ITSP. For security reasons, the password field will be shown as empty.
 - **Outbound Proxy** with your outbound proxy IP address or FQDN. Leave empty if not available.
6. Press **Save and Apply** to save your configuration.

After applying your configuration, your phone will register to your SIP Server. You can verify if your device has registered with your SIP server from its web interface under **Status** → **Account Status** ("**Registered**" with green color when the account is correctly registered, or "**Unregistered**" with red when the account is not properly registered)

Register Account via LCD Menu

To register your SIP account via the LCD menu, please refer to following steps:

1. Unlock your handset and press **Menu** to bring up operation menu.
2. Use arrow keys to reach **Settings** and then select **Account** tab.
3. Select which account you want configure and then set the following:
 - **Enable Account** to "Enable".
 - **Account Name**: Any name to identify this specific user.
 - **SIP Server** field with your SIP server IP address or FQDN.
 - **SIP User ID**: User account information, provided by VoIP service provider (ITSP). Usually in the form of digit similar to phone number or actually a phone number.
 - **SIP Authenticate ID**: SIP service subscriber authenticate ID used for authentication. Can be identical to or different from SIP User ID.
 - **SIP Authentication Password**: SIP service subscriber's account password to register to SIP server of ITSP. For security reasons, the password field will be shown as empty.
 - **Voicemail Access Number**: The voicemail number of your account.
 - **Display Name**: The name that will be used for caller ID name in SIP INVITE.
 - **Account Ringtone**: Choose the preferred ringtone for this account.
 - Press "**save**" softkey to apply the configuration

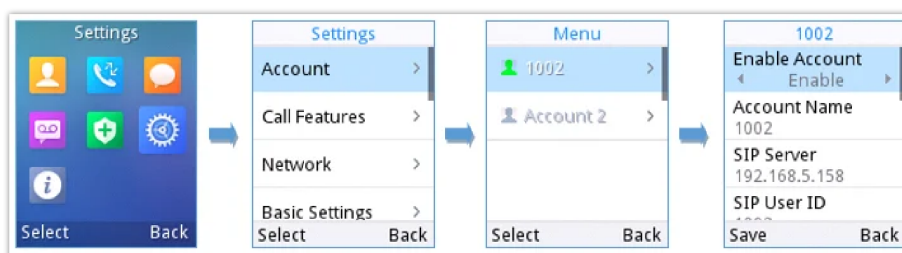

Figure 25: SIP Accounts Configuration

PHONE SETTINGS

Selecting Phone Language

The WP810/WP822/WP825 support different languages. The default language of the handset is English. To change the language of the handset, please proceed as follows:

1. Press **Menu** to bring up operation menu.
2. Use arrow keys to reach **Settings**.
3. Navigate to **Basic Settings**, and then select **Language**.
4. Choose the desired language from the available list and press "**Select**" and then the phone will apply the selected language.

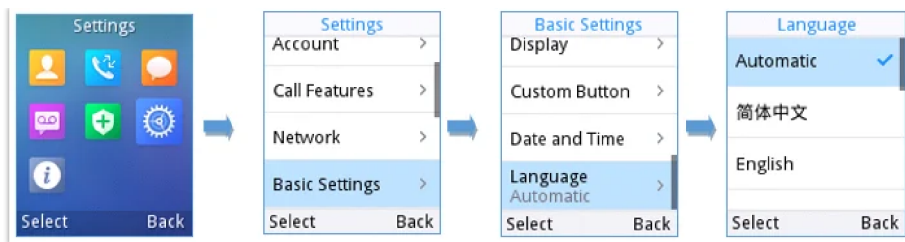



Figure 26: Configuring Phone Language

Activate/Deactivate Hands-Free Mode

- Press the **Hands-free key**  while making a call or on the idle screen to activate hands free mode.
- Press the **Hands-free key**  again to deactivate the hands-free function.

Muting the Microphone

- Press the button **“Options” (Left softkey)** during an established call and a list of the options will be displayed.
- Choose **“Mute”** and press **“Select”** button (left softkey / OK button) to switch on the microphone.

Notes:

- While muted, the icon  will be displayed on the screen.
- To unmute the microphone during an established call, press the button **“Options” (Left softkey)**, choose **“Unmute”** and press **“Select”** button (left softkey or OK button) to switch off the microphone.

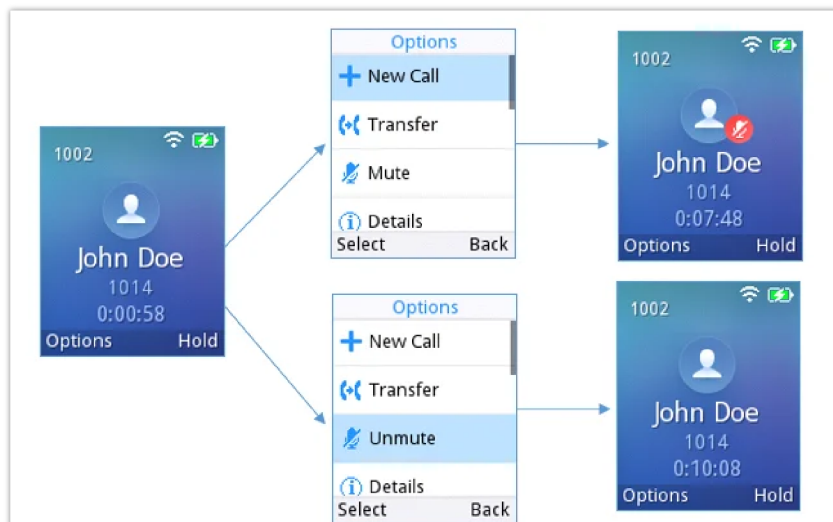

Figure 27: Muting the Microphone

Note

If PTT/Paging button is customized by the administrator to be Mute/Unmute, users can press the Multi-function button to Mute/Un-mute the MIC during calls.

Adjusting Speaker and Earpiece Volume

Press volume up and down keys on the left side of your phone while you are on an established call to set the volume of the earphone / speaker. You can choose between 8 different levels. The default level is 4.

Ringtones

Setting the Ringer Volume

To configure the desired ringer volume, proceed as follows:

1. Press **Menu** to bring up operation menu and go to **Settings**.
2. Navigate to **Basic Settings**, and then select **Sound** tab.
3. User can configure the silent and vibrate modes and also the voice ringtones by pressing the left and right arrow keys to change repeatedly and set the desired volume.
4. Press "**Back**" (right softkey) to confirm the new configuration settings.

Notes:

- 8 levels are supported. Level 8 is the highest level. Level 5 is the default.
-  appears when silent mode is enabled. In this mode no ring will be played for incoming calls.

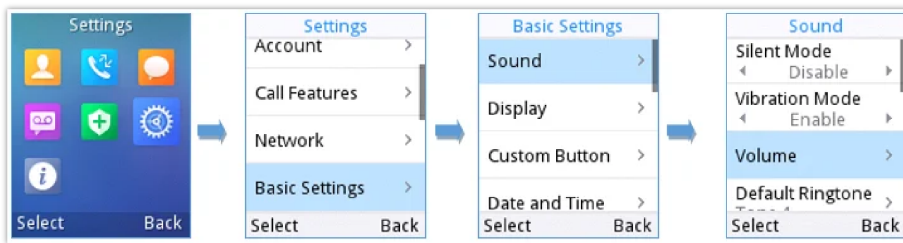

Figure 28: Ringer Volume

Setting the Ringtones

You can change the ringer melody for an incoming call. The device has different ringer melodies and in order to configure the desired melody, proceed as follows:

1. Press **Menu** to bring up operation menu.
2. Use arrow keys to reach **Settings** → **Basic Settings**, and then select **Sound** tab.
3. Go to "**Default Ringtone**", and choose the desired ringtones, press "**Save**" to confirm the ringtones selected and the new ringtones will be set successfully.

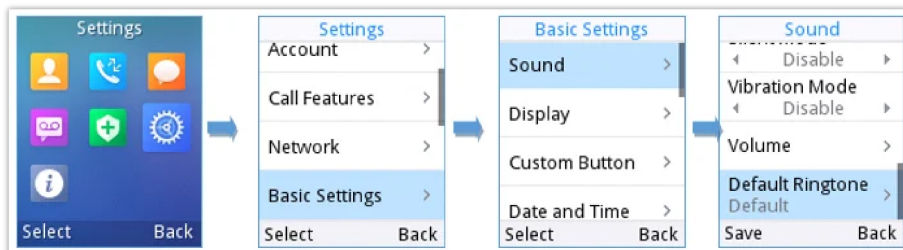

Figure 29: Calls Default Ringtone

Date and Time

On the WP810/WP822/WP825 the Date and time are displayed on the idle screen and it obtains the date and time from the Simple Network Time Protocol (SNTP) server by default. If your phone cannot obtain the date and time from the SNTP server, you need to configure the date and time manually. You can configure the time format and date format respectively. The handset supports two formats for time (12 Hour or

Hour) and three date formats (DD/MM/YYYY; MM/DD/YYYY; YYYY/MM/DD).

To configure date and time manually

1. Press **Menu** to bring up operation menu.
2. Use arrow keys to reach **Settings** → **Basic Settings**, and then select **Date and Time** tab.
3. Press “**Back**” softkey to apply your changes.

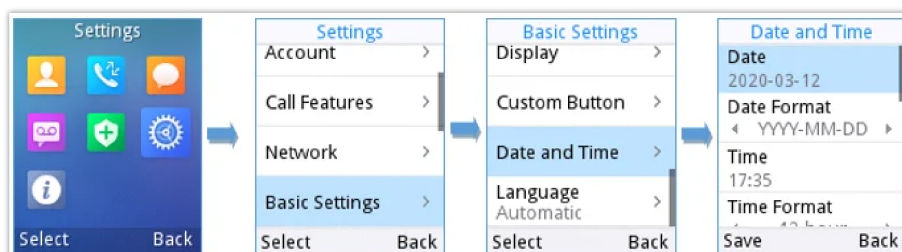

Figure 30: Date and Time Settings

Reboot

To reboot the handset, please refer to following steps:

1. Access the handset **menu** → **Settings** → **Advanced Settings** → **Reboot**.
2. A confirmation LCD message will be displayed to confirm the reboot, press “**Reboot**” button to reboot the phone or “**Cancel**” to cancel the reboot.

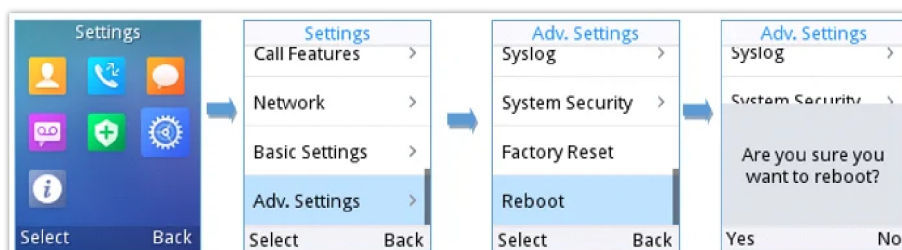

Figure 31: Reboot

CALL OPERATIONS

Placing calls

To place calls, you can use the following mode:

- **Earpiece mode:** pressing the off-hook / dial key to dial out.
- **Speakerphone mode:** pressing the speakerphone key to dial out.
- **Headset mode:** pressing the off-hook / dial key to dial out using connected headset.

During the call, you can switch the call mode by pressing the corresponding keys or connecting a headset.

Make a Call using a Line

Making calls require the use of SIP lines. So, you should first register the SIP account to the handset beforehand, after registering the sip lines, you can choose between them while trying to make calls by pressing the “**Accounts**” button displayed on the call screen. Please refer to following methods to make calls using a line:

1. Enter the desired number using the keypad.
2. Toggle between the available lines by pressing the “**Account**” button to choose the line for making calls. (The account name will change on the screen when press “Account” button).
3. Press **Dial key**  , left softkey “**Call**”, # (Use # as dial key” must be configured in web configuration) to initiate the call or wait for 4 seconds and the call will be initiated automatically.

Note: Users can also initiate calls with handsfree mode using **Speaker key**  .

4. To terminate the call, press **Hang-Up key**  .

Notes:

- To dial from contacts list, choose a contact using navigation keys and press **Dial key**  .
- When having un-read voicemails on the handset, once accessing the dialing interface a stutter tone will be heard to notify users about voicemails that need to be read.
- The maximum length of dialed digits is limited to 30 characters.

Dialing from Call history

Users may use their call history entries to initiate calls. Please refer to following steps:

1. Press **Menu** to bring up operation menu.
2. Use arrow keys to reach **Call History**.
3. Select the desired entry and press **Dial** key to establish the call.

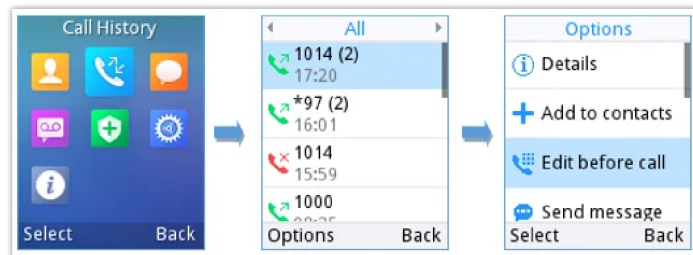



Figure 32: Dialing from Call History

Note

In step 3, users can press “**Options**” softkey followed by “**Edit before Dialing**” option to edit the number before initiating the call. The call history list stores the last dialed phone numbers. When the memory of the redial number list is full, the handset will automatically erase oldest dialed number when a new number is dialed.

Dialing from Phonebook

Users may use their contacts list to initiate calls.

1. Press **Menu** to bring up operation menu and use arrow keys to reach **Contacts** or press **Contacts key**  to access directly the contacts list.

2. Select the contact to call and press **Dial Key** to initiate the call.

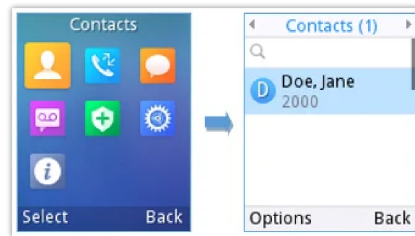

Figure 33: Dialing from Contacts List

Direct IP Call

Direct IP Call allows two phones to talk to each other in an ad-hoc fashion without a SIP proxy. VoIP calls

can be made between two phones if:

- Both phones have public IP addresses; or
- Both phones are on the same LAN/VPN using private or public IP addresses; or
- Both phones can be connected through a router using public or private IP addresses (with necessary port forwarding or DMZ).

To make a direct IP call, dial ***47** followed by the IP address of the target. Following the below syntax (Example target IP is 192.168.1.10):

- Dialing *47192*168*1*10 (to use 5060 port by default)
- Users can specify the port number as follows *47192*168*1*10#5062.

Note

In order to receive an IP call, user need to disable using a random port, under **Web GUI → Settings → General Settings** : Set "Use Random Port" to **No**.

Answering Calls

When receiving an incoming call, you can answer the call using following steps:

- **Earpiece mode:**

Press **Dial Key** to pick up the call, or "Accept" softkey (left softkey).

- **Speakerphone mode:**

Press **Speaker Key** to pick up the call.

- **Headset mode:**

Press **Dial Key** to pick up the call, or "Accept" softkey (left softkey) using a connected headset.

Note:

To answer an incoming call during an established call, press **Dial Key**, or the **Speaker Key**, or the "Answer" softkey. The incoming call is answered, and the original call is placed on hold.

Auto Answer

Users can enable Auto Answer feature to accept and automatically answer incoming calls.

If enabled, the WP810/WP822/WP825 will automatically answer incoming calls using speaker mode.

To activate / deactivate the auto answer feature:

◦ Using LCD Menu

1. Press **Menu** to bring up operation menu.
2. Use arrow keys to reach **Settings** → **Call Features** → **Auto answer**.
3. Select which account will be enabling the Auto answer feature.
4. Set "**Auto-Answer**" to "Enabled" and configure the auto-answer mode and press "**Save**" button.

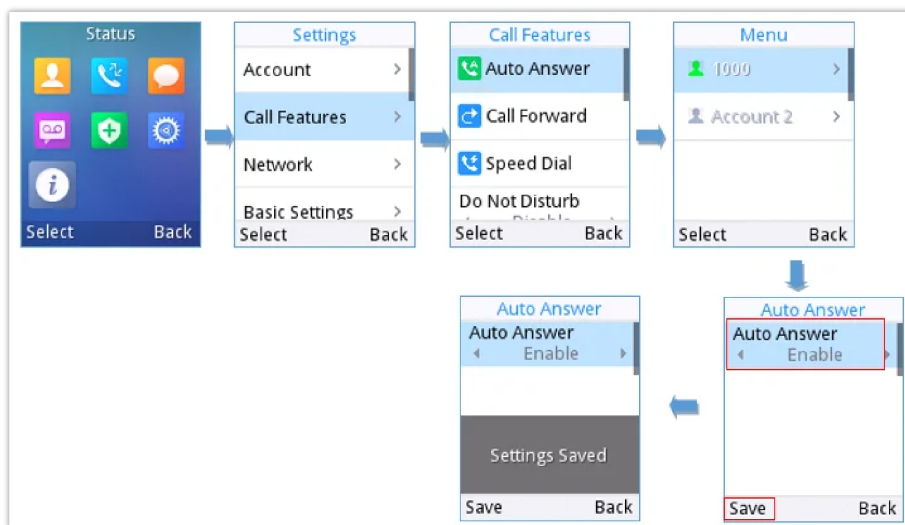

Figure 34: Auto-answer

◦ Using Web Interface

1. Access Web GUI Interface.
2. Navigate to **Account** → **Call Settings**.
3. Set "**Auto Answer**" to "**Yes**". (By default, set to "**No**").

Ending Calls

To terminate the calls, press **Hang-Up** key



Rejecting Calls

To reject an incoming call, press **Hang-Up** key



Call Hold/Resume

- During active call, press the right softkey "**Hold**" to put the established call on hold.
- To resume the call, press the right softkey "**Unhold**" while the established call is being on hold.

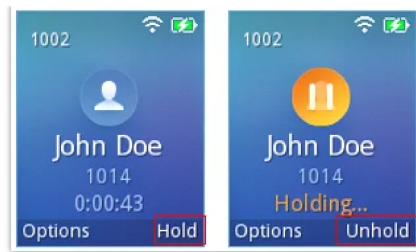

Figure 35: Hold/Unhold Calls

Note

If you press on "Options" during the established call, and then make a new call to another number, the first call will be on hold automatically and users can put up to 2 calls on hold at the same time.

Call Waiting

This feature will notify you of a new incoming call during an established call and display the incoming call information visually on the LCD screen and a call waiting tone will be heard. If this feature is disabled, the new incoming call will be automatically rejected.

This feature is enabled from the Web GUI:

1. Access **Web Interface**.
2. Go to **Settings → Call Features**
3. Set "**Disable Call Waiting**" and "**Disable Call Waiting Tone**" to "No". (Default is No).
4. Press **Save and Apply buttons** to confirm the new settings.

Users now will be able to hear the call waiting tone and it will be visible as well on the LCD screen as displayed on the following screenshot.



Figure 36: Call Waiting

Do Not Disturb

You can activate or deactivate the DND mode for your accounts registered on the handset from its LCD menu. If DND mode is activated, all incoming calls will receive busy treatment depending on your configuration (forward to voice mail, busy tone...).

To enable or disable the DND mode, Access LCD Menu → **Settings → Call Features → Do not disturb** and set **Do not disturb** to **Enabled**.

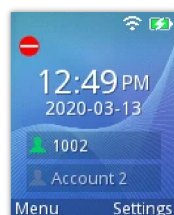

Figure 37: DND Enabled

Call Forward

The call forward feature will allow you to forward all the incoming calls to the desired number. Three possible call forward types are available.

- **Unconditional:** All the incoming calls are immediately forwarded to the desired number.
- **Time Based:** Incoming calls are immediately forwarded to the desired number based on the configured time.
- **Others:** Incoming calls are forwarded to the desired number when Busy, when DND is enabled or when there is no response.

To enable the call forward, please refer to the following steps:

1. Press **Menu** to bring up operation menu.
2. Use arrow keys to reach **Settings** → **Call Settings** → **Call forward**.
3. Select which account will be enabling the call forwarding feature and navigate to “**Call forwarding**”.
4. Set “**Call Forward**” to “**On**” and select the call forwarding mode.
5. Configure the parameters of the call forward mode and press “**Save**” button.

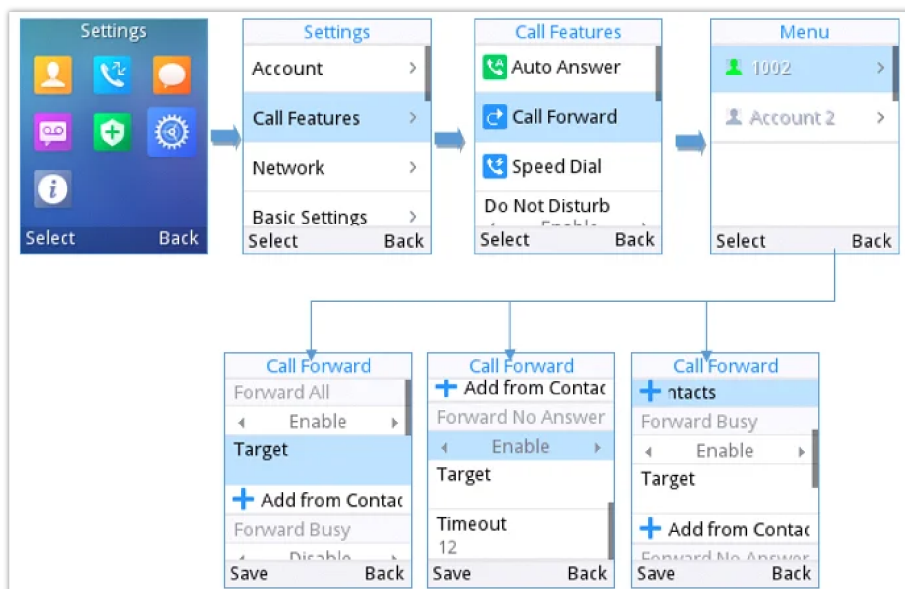

Figure 38: Call Forwarding

- **Unconditional:** All the incoming calls will be forwarded to the number set up in “All To” field.
- **Time Based:** All the incoming calls will be forwarded to the number as schedule in the time period. During the setup time, the call will be forwarded to the number in “In Time Forward To:” field. Other period the call will be forwarded to the number in “Out Time Forward To:” field.
- **Others:** The incoming call will be forwarded when the handset is busy or no answer after certain interval “Delayed Call Forward Wait Time (s)” or if the phone is set to DND mode.

Note

The call forwarding can be also configured from the **Web GUI** → **Accounts** → **Feature codes**.

Call Transfer

The WP810/WP822/WP825 support the call transfer feature, you can transfer a call to another party using one of the following ways:

- **Blind transfer:** Transfer a call directly to another party without consulting
- **Attended transfer:** Transfer a call with prior consulting.

Blind Transfer

1. Press “Transfer” softkey during a call, and then enter the number you want to transfer the call to.
2. Select Blind transfer by pressing on **Blind** key.
3. The call is connected to the number you specified, and the LCD screen prompts Call Transferred.

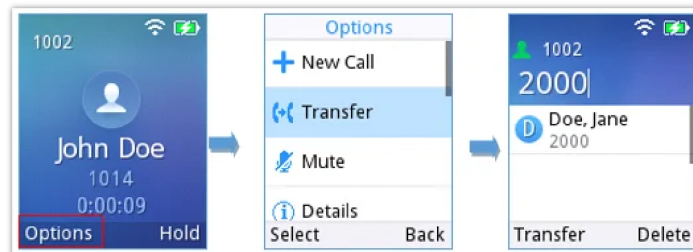

Figure 39: Blind Transfer

Speed Dial

Speed dial allows users to perform single-digit dialing to predefined numbers. This feature is particularly useful to speed up dialing frequently used or hard to remember numbers. A maximum of 10 speed dial numbers is allowed. For example, the digit key 2 is configured as a speed dial key and assigned the number 4000, the phone will dial out the number 4000 directly when you long press digit key 2.

Note

The speed dial number should not be set on chosen representative number, otherwise long press will initiate a call to configured speed dial number.

To configure the speed dial (create, edit or delete) numbers, proceed as the following steps:

1. Press **Menu** to bring up operation menu and use arrow keys to reach **Settings** → **Call Features** → **Speed dial**.
2. Select the speed dial key to be configured and press “**Select**” softkey.
3. Select the associated account and the number to be dialed.
4. Press “**Save**” softkey to save the configured speed dial numbers.

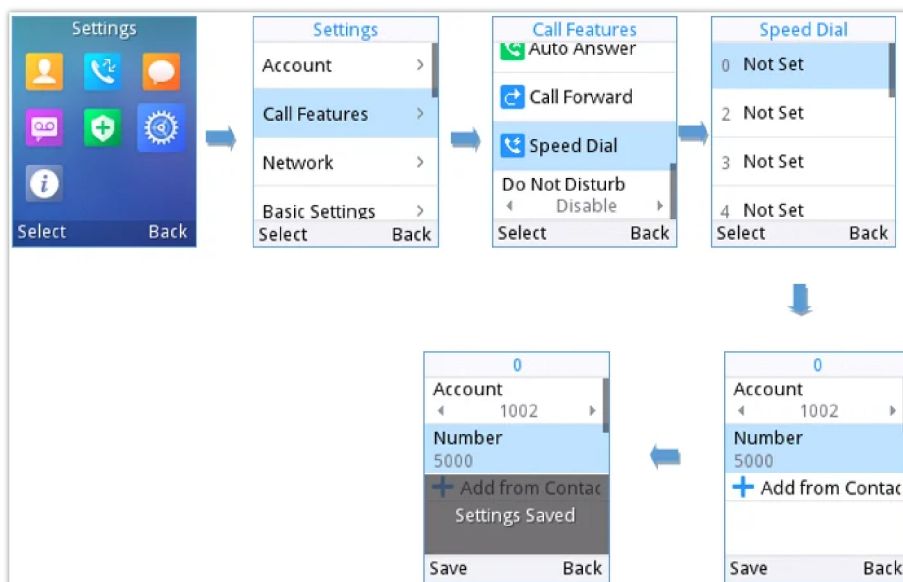

3-Way Conference

The WP810/WP822/WP825 support creating a local conference with other parties (including handset starting the conference). To start a 3 Way conference, follow below steps:

1. Place a call to the first party and press left softkey "Options", then select "Conference".
2. Enter the number of the second party you want to add to the conference and press **Join Conf.**
3. The conference will automatically be bridged before the third party answers the call.

Please refer to the following screenshots for more details.

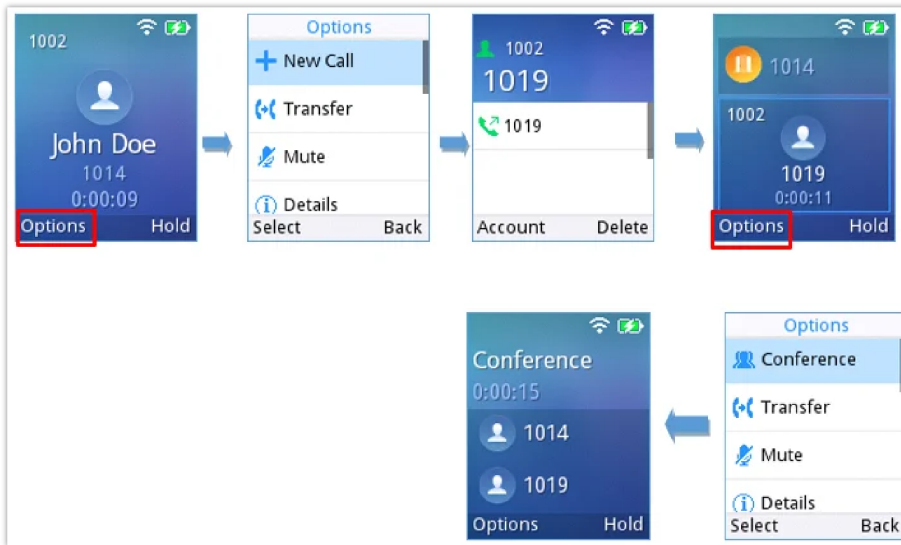

Figure 41: 3-way Conference Call

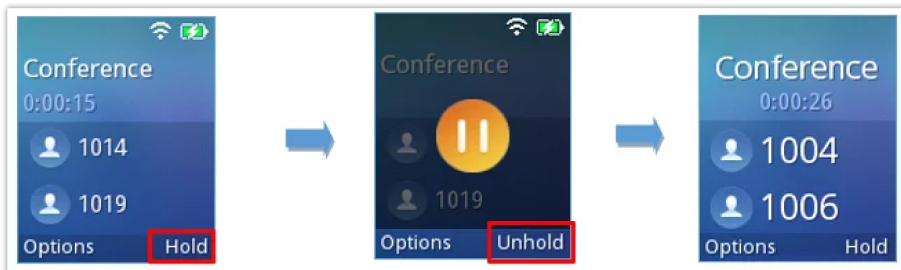

Figure 42: 3-way Conference Call on Hold

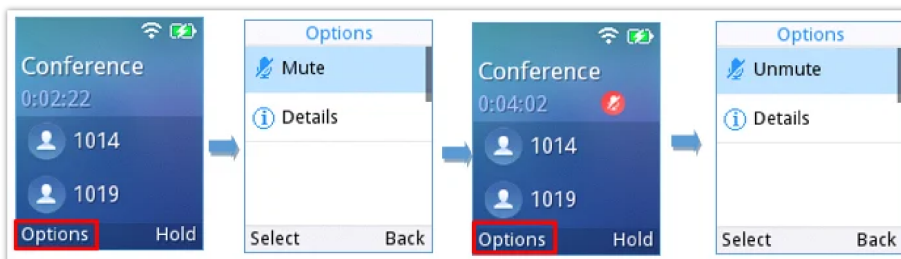

Figure 43: 3-way Conference Call Muted/Unmuted

UCM Conference

Participate in UCM Conference Room

Users could dial the UCM conference room extension to join the conference. If password is required, enter the password to join the conference as a normal user, or enter the admin password to join the conference as administrator.

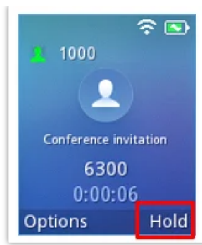

Figure 44: Join UCM Conference Room

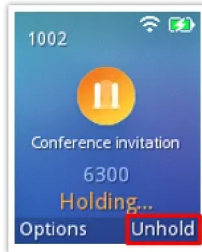

Figure 45 : UCM Conference Room Call put on Hold.

Voice Mail

The voice mail feature ensures that you will never miss any important messages. It permits either to leave voice mails to someone else or receive and listen to voice mails via the handset

Set Voice Mail ID

There are 2 ways to set Voice Mail Feature Code, either using the Handset Menu or Web Interface.

Note: The Voice Mail Feature Code depends on the service provider or IP-PBX used. For example, if UCM6xxx as SIP server, the Voice Mail Feature Code is ***97**.

Using LCD Menu

1. Press **Menu** to bring up operation menu.
2. Use arrow keys to reach **VoiceMail** tab.
3. Select the desired account and configure the **VoiceMail ID** number, then press **"Save"** softkey.

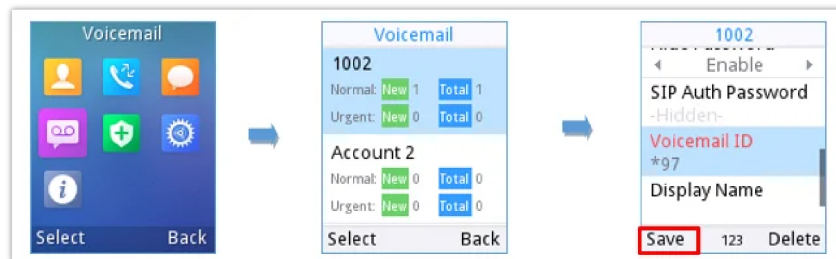

Figure 46: LCD Menu – Voice Mail ID

Using Web Interface

1. Access Web GUI Interface.
2. Go to Accounts → Account x → General Settings
3. Configure **Voice Mail Access Number**.

General Settings

Account Active	<input type="radio"/> No <input checked="" type="radio"/> Yes
Account Name	<input type="text" value="1000"/>
SIP Server	<input type="text" value="192.168.5.82"/>
Secondary SIP Server	<input type="text"/>
Outbound Proxy	<input type="text"/>
Backup Outbound Proxy	<input type="text"/>
BLF Server	<input type="text"/>
SIP User ID	<input type="text" value="1000"/>
Authenticate ID	<input type="text" value="1000"/>
Authenticate Password	<input type="text"/>
Name	<input type="text"/>
Voice Mail Access Number	<input type="text" value="*97"/>
Picture	<input type="button" value="Select"/>
Account Display	<input checked="" type="radio"/> User Name <input type="radio"/> User ID

Figure 47: Web UI – Voice Mail Access Number

Play Voice Mail Messages

1. Press **Menu** to bring up operation menu.
2. Use arrow keys to reach **Voicemail** tab.
3. Choose the account, press **“Select”** button and enter Voicemail password then you can select visually and retrieve your voice messages saved on your voice mail and listen to each individual voicemail.

Note: this feature is compatible with UCM6xxx on v.1.0.20.6 or higher.

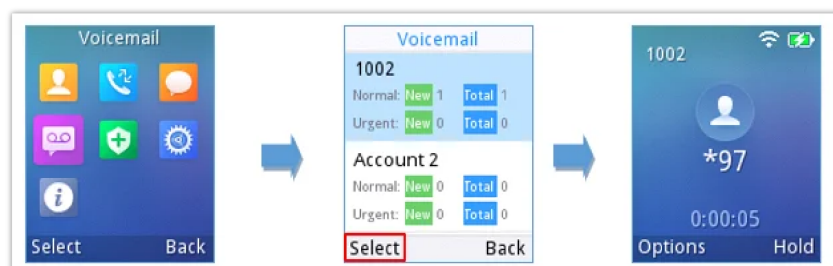

Figure 48: Playing Voicemail Messages

Notes

- If VM is protected by a password, users can enter the password using the handset keypad after reaching Voice Mail system. The password is defined on the service provider or IP-PBX side.
- When having un-read voicemails on the handset, once accessing the dialing interface a stutter tone will be heard to notify users about voicemails that need to be read.

CONTACTS

Users can manage local contacts by adding, deleting and modifying every single contact. Users could access contacts under the handset Menu. *Please, refer to the following screenshots:*

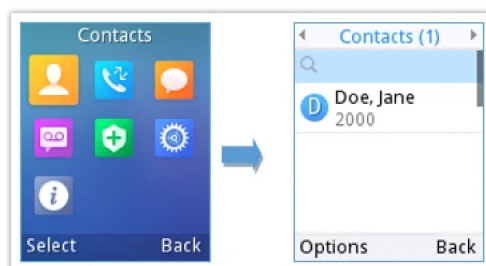

Figure 49: Accessing Contacts

Notes

- The WP810/WP822/WP825 support 500 contacts as maximum number of local contacts.
- The WP810/WP822/WP825 support to display contacts with no numbers in the phonebook.

The following operations can be done under local contacts screen:

- **New contact:** Under “Option”, users can select “New Contact” in order to manually add the contacts information and details. *Please, see the following screenshots and table:*

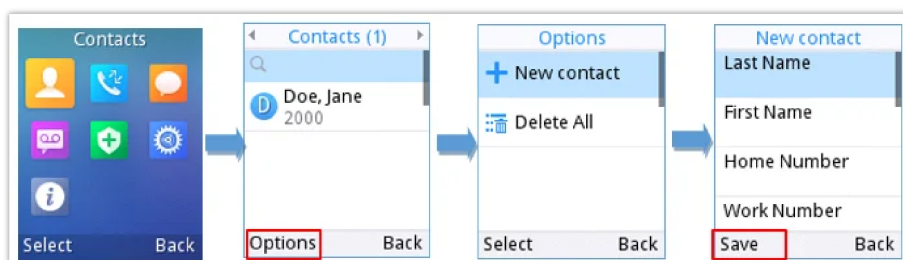



Figure 50: Create a new contact

Last Name	Enter the contact’s last name.
First Name	Enter the contact’s first name
Work Number	Enter the contact’s work phone number.
Home Number	Enter the contact’s home phone number.
Mobile Number	Enter the contact’s mobile phone number.
Groups	Choose the group you want to include your contact into.
Ringtone	Choose a specific ringtone for the account’s received calls.
Account	Choose the default account you want to dial with this contact.
Primary	Select which number is the primary choice.

Table 21: New Contact Parameters

- **Search for a contact:** in case finding a specific contact among a batch of contacts is difficult, users can press the middle button for “Search” and enter the name of the contact to find it easily.
- **Send Message:** Select a contact to send IM message, up to 160 characters.
- **Dial out from Contacts:** Select the needed contact and tap on the dial key  to call it directly. The phone will use the configured account on contact’s information to dial out with.
- **Delete:** Users can delete a specific contact by tapping on “Delete contact”.
- **Delete All:** Users can delete the whole list of local contacts by tapping on “Clear all contacts”.

CALL HISTORY

Call history provides users access to phone’s call logs in different categories and help users to make some operations directly. Call history can be accessed under menu as shown on the following figure:

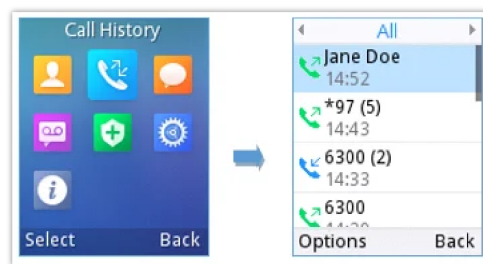



Figure 51: Call History

There are four different categories in the call history. Users could use the phone’s right and left arrows to view the following categories: All Calls, Missed Calls, Dialed Calls, Received Calls.

Dial Out from Call History

Select one of the call history log and tap on the dial key  to call this number directly. The phone will use the same account as the call log to dial out.

Call History Options

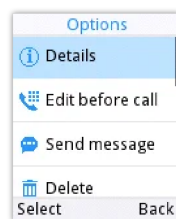



Figure 52: Call History Options

- **Add to contacts:** Users can tap on this option to add the number listed on the selected call history entry to local contacts.
- **Edit before dialing:** Users could copy the number to the dial screen in order to edit it before dialing.
- **Delete:** Users could delete the selected call history log by tapping on “Delete”.
- **Delete all:** This option helps users to clear all the call history.

MESSAGES

The WP810/WP822/WP825 has built-in SMS application to send/receive message, if the SIP server supports SMS message. Users can create, edit draft and delete one or all the messages. Tap  on phone's menu to launch SMS application.

View Messages

On the Messages list screen, under Inbox tap on one of the messages using the OK button to view the Messages details.

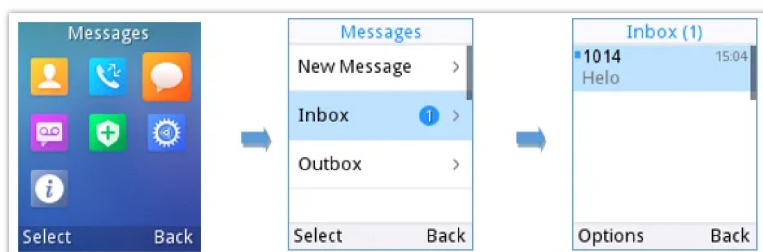

Figure 53: View Messages Dialog

Create Messages

Tap on "New" in Messages application to start composing a new message.

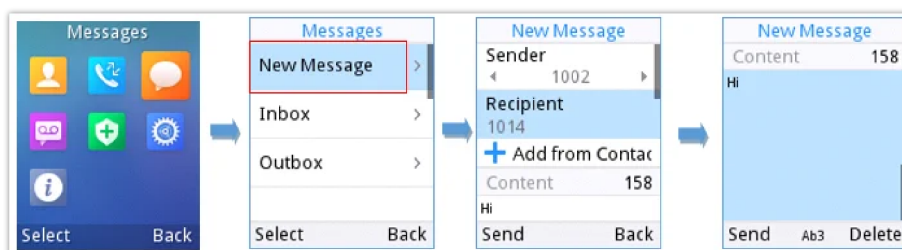

Figure 54: Create a New Message

1. Select the account to send the message from by tapping on "Account".
2. Add number to send the message to in Recipient section. (**Note:** Users could click on "Add" to add existing contacts to Recipient list.
3. Input content: Enter the message content on the next field of the screen. Tap on "Send" once finished, a "Sending" message will prompt and the message is confirmed as sent once the "Sending" message prompt disappears.

Delete Messages

1. On the messages list, tap on "Options" to show more options.
2. Tap on "Delete message" to delete the selected message, or on "Delete all" to delete all the messages/drafts.

Note

Under "Options", users can also find "Add to contacts" option to directly include the number selected on the local contacts.

CALL FEATURES

The WP810/WP822/WP825 support traditional and advanced telephony features including call forward and etc.

*72	<p>Unconditional Call Forward. To set up unconditional call forward:</p> <ul style="list-style-type: none"> ◦ Off hook the phone. ◦ Dial *72 and then enter the number to forward the call. ◦ Press Call softkey or Dial key.
*73	<p>Cancel Unconditional Call Forward. To cancel the unconditional call forward:</p> <ul style="list-style-type: none"> ◦ Off hook the phone. ◦ Dial *73. ◦ Press Call softkey or Dial key.
*74	<p>Paging Call. To establish a paging call:</p> <ul style="list-style-type: none"> ◦ Off hook the phone. ◦ Dial *74. ◦ Press Call softkey or Dial key.
*90	<p>Busy Call Forward. To set up busy call forward:</p> <ul style="list-style-type: none"> ◦ Off hook the phone. ◦ Dial *90 and then enter the number to forward the call. ◦ Press Call softkey or Dial key.
*91	<p>Cancel Busy Call Forward. To cancel the busy call forward:</p> <ul style="list-style-type: none"> ◦ Off hook the phone. ◦ Dial *91. ◦ Press Call softkey or Dial key.
*92	<p>No Answer Call Forward. To set up delayed call forward:</p> <ul style="list-style-type: none"> ◦ Off hook the phone. ◦ Dial *92 and then enter the number to forward the call. ◦ Press Call softkey or Dial key.
*93	<p>Cancel No Answer Call Forward. To cancel the delayed call forward:</p> <ul style="list-style-type: none"> ◦ Off hook the phone. ◦ Dial *93. ◦ Press Call softkey or Dial key.

Table 22: Call Features

PTT (PUSH-TO-TALK) FUNCTIONALITY

The WP810/WP822/WP825 support the Push to talk (PTT) features which is a technology based on the instantaneous communication commonly employed in wireless cellular phone services using a button to switch the device from voice transmission mode to voice reception mode. This feature is similar to “walkie talkie” use and the PTT mode switches a phone from full duplex mode, where both parties can hear each other simultaneously, to half duplex mode, where only one party can speak at one time. Multiple parties to the conversation may also be included.

Enabling PTT mode

You can enable and configure the PTT settings using the handset LCD menu:

1. Press **Menu** to bring up operation menu.
2. Use arrow keys to reach **Settings** → **Advanced settings** → **PTT and paging**.
3. Choose **PTT settings** and enable the **PTT function**.
4. Press **Save** button to enable PTT mode.

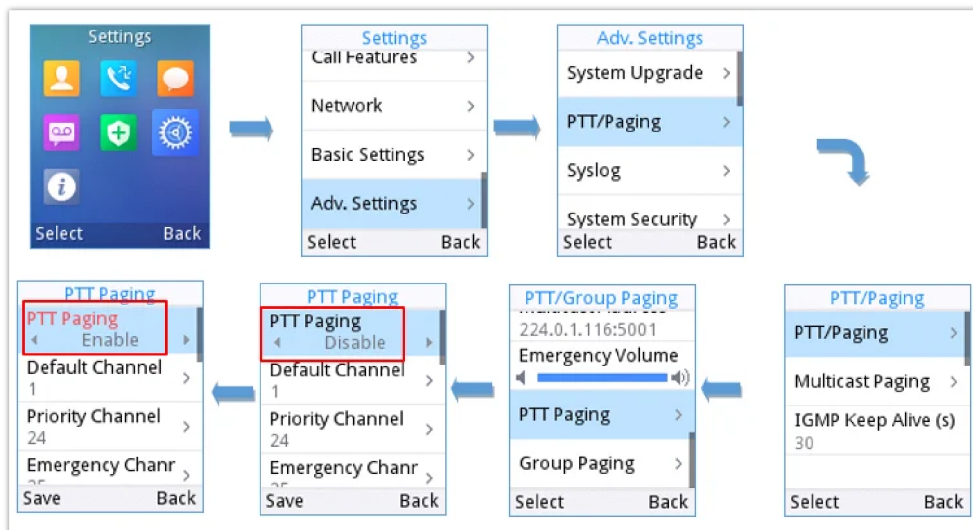

Figure 55: Enabling PTT Feature

Using the PTT Functionality

To send a PTT broadcast:

1. Unlock your handset.
2. Make sure the multi-function button is configured to be a Push-To-Talk button.
3. Press the Push to Talk soft key.
4. Press and hold the Push to Talk key while speaking.

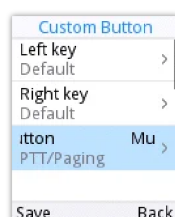

Figure 56 : Custom Button set to PTT/Paging

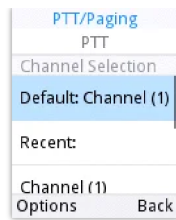

Figure 57: PPT Channel

Notes

- Users could press and hold the Push-to-talk key from any screen to quickly initiate PTT call using default channel.
- The channel status will change to Sending PTT to indicate that you are transmitting as displayed on the following screenshot.

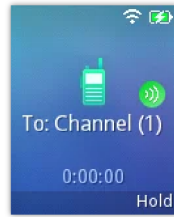

Figure 58: PTT Call (Caller)

5. The devices which are in the same channel will receive the PTT call.
6. Release the Push to Talk soft key when you have finished speaking. The channel will wait 10 seconds before release.

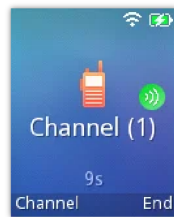

Figure 59: PTT Call Release

7. You should press the Push to Talk soft key only when the channel status indicates Waiting. Otherwise, you may interrupt another person's message.

PTT Configuration Settings

Please refer to the following Settings for more details about the configuration of the PTT functionality:

Settings

- **Multicast address:** The multicast IP address to send page audio to and receive page audio from. Default value is 224.0.1.116.
- **Port:** The port to send audio to and receive audio from. Default value is 5001
- **Emergency volume:** The Volume of the emergency channel. Default value is 8

PTT Parameters

- **PTT function:** Enable or disable the PTT function.
- **Default channel:** The PTT channel used to transmit an outgoing page if the user does not explicitly specify a channel.

- **Priority channel:** The channel assigned for priority pages.
- **Emergency channel:** The channel assigned for emergency pages.
- **Accept while busy:** If no, incoming PTT sessions do not produce standard call waiting. If yes, incoming PTT sessions produce standard call waiting behavior on the active audio channel.
- **CallerID(*):** Caller ID number for identification.
- **PTime:** The audio payload size in milliseconds.
- **Audio codec:** The audio codec to use for outgoing PTT broadcasts. Incoming PTT audio will be decoded according to the codec specified in the incoming message.
- **Channel:** Set the channel whether to be usable, transported, acceptable, joined and the channel display name.

Group Paging

Enabling Group Paging Feature

You can enable and specify settings for the Group Paging feature through the phone's user interface.

To specify the Group Paging feature settings:

1. Using your phone's interface, navigate to the Group Paging Configuration menu by pressing **Settings**→ **Advanced setting**→ **PTT and paging**→**PTT and group paging**.
2. Choose Group Paging Configuration.
3. Set Group Paging function to Enabled.

Please, refer to the following screenshots:

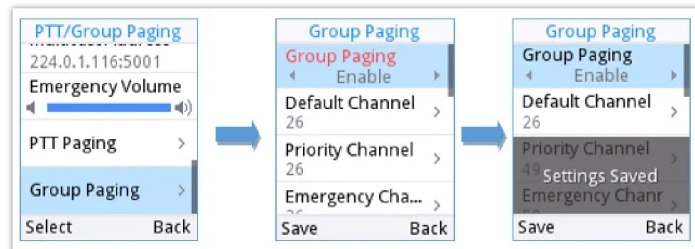

Figure 60: Group Paging

To send a Group Paging broadcast:

1. Unlock your handset.
2. Press the Talk soft key.
3. Set Default mode to Group paging.
4. Scroll to the group you wish to send a broadcast to.
5. Press and hold the Talk soft key before speaking.

The group status will change to Sending group paging to indicate you are transmitting.

The devices which are in the group will receive the paging.

6. Release the Talk soft key, press the on-hook/power key when you have finished speaking.

Group Paging Parameters

- **Paging function:** Enable or disable the Group paging function.
- **Default group:** The group used to transmit an outgoing page if the user does not explicitly specify a group.
- **Priority group:** The group assigned for priority pages.
- **Emergency group:** The group assigned for emergency pages.
- **Accept while busy:** If no, incoming Group paging sessions do not produce standard call waiting. If yes, incoming PTT sessions produce standard call waiting behavior on the active audio group.
- **Caller ID(*):** Caller ID number for identification.
- **P-Time:** The audio payload size in milliseconds.
- **Audio codec:** The audio codec to use for outgoing Group paging broadcasts. Incoming Group paging audio will be decoded according to the codec specified in the incoming message.
- **group:** Set the group whether to be available, transmit, subscribe, join group and the group name.

IGMP Settings

Users could specify how often the phone will report IGMP when PTT/ Paging function is turned on. IGMP reporter help to keep PTT/ Paging receivable in dormant state. The interval may take some effect to standby time. The default setting is 30 s.

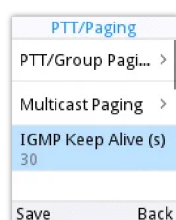

Figure 61: IGMP setting

UPGRADING AND PROVISIONING

The WP810/WP822/WP825 can be upgraded via TFTP/HTTP/HTTPS by configuring the URL/IP Address for the TFTP/HTTP/HTTPS server and selecting a download method. Configure a valid URL for TFTP, HTTP or HTTPS; the server name can be FQDN or IP address.

Examples of valid URLs:

firmware.grandstream.com/BETA

fw.mycompany.com

Upgrade and Provisioning Configuration

There are two ways to setup upgrade and provisioning on WP810/WP822/WP825. They are Keypad Menu and Web GUI.

Configure via keypad Menu

1. In handset Settings, select **Advanced Settings** → **System Upgrade**.
2. Navigate to **Firmware/Config** and configure the firmware upgrade and config settings.

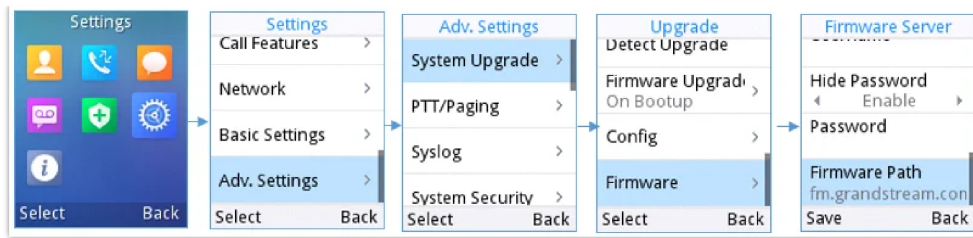

Figure 62: Upgrade Configuration via Keypad Menu

Configure via Web GUI

Open a web browser on PC and enter the IP address for the handset. Then login with the administrator username and password. Go to **Maintenance → Upgrade and Provisioning → Firmware**. In the Upgrade web page, enter the IP address or the FQDN for the upgrade server and choose to upgrade via TFTP, HTTP, HTTPS, FTP or FTPS (The default setting is HTTP). Save and apply the changes, press **Save and apply** button then reboot the phone to initiate firmware upgrade process.

Figure 63: Upgrade Configuration via Web GUI

Warning

Please do not power off or unplug the device when the upgrading process is on.

Upload Firmware Locally

If there is no HTTP/TFTP server, users could also upload the firmware to the device directly via Web GUI. Please follow the steps below to upload the firmware locally.

1. Download the latest firmware file from the following link and save it in your PC.

<https://www.grandstream.com/support/firmware>

2. Log in the Web GUI as administrator in the PC.
3. Go to Web GUI→**Maintenance**→**Upgrade and Provisioning** → **Firmware**.
4. Click the “Start” button under “Upgrade Firmware”, a window will be prompted to select firmware file to upload.
5. Select the firmware file from your PC. Then uploading progress will show on the window.
6. When uploading is done, users can see the upgrading process starts on the device LCD.
7. The phone will reboot again with the new firmware version upgraded.

No Local Firmware Servers

Service providers should maintain their own firmware upgrade servers. For users who do not have a TFTP/HTTP/HTTPS server, some free Windows version TFTP servers are available for download from:

<https://www.solarwinds.com/free-tools/free-tftp-server> and <https://www.tftpd64.com/>.

Please check our web site at <https://www.grandstream.com/support/firmware> for latest firmware.

Instructions for local firmware upgrade via TFTP:

1. Unzip the firmware files and put all of them in the root directory of the TFTP server.
2. Connect the PC running the TFTP server and the device to the same LAN segment.
3. Launch the TFTP server and go to the File menu→Configure→Security to change the TFTP server's default setting from "Receive Only" to "Transmit Only" for the firmware upgrade.
4. Start the TFTP server and configure the TFTP server in the phone's web configuration interface.
5. Configure the Firmware Server Path on your device to the IP address of the PC.
6. Update the changes and reboot the device.

End users can also choose to download a free HTTP server from <https://httpd.apache.org/> or use Microsoft IIS web server.

Provisioning and Configuration File Download

Grandstream SIP Devices can be configured via the Web Interface as well as via a Configuration File (binary or XML) through TFTP or HTTP/HTTPS FTP/FTPS. The "Config Server Path" is the TFTP, HTTP or HTTPS, FTP or FTPS server path for the configuration file. It needs to be set to a valid URL, either in FQDN or IP address format. The "Config Server Path" can be the same or different from the "Firmware Server Path".

A configuration parameter is associated with each particular field in the web configuration page. A parameter consists of a Capital letter P and 1 to 5 (could be extended to more in the future) digit numeric numbers. i.e., P2 is associated with the "Admin Password" in the Web GUI→**Maintenance**→**Web Access** page. For a detailed parameter list, please refer to the corresponding firmware release configuration template in the following link:

<https://www.grandstream.com/support/tools>

When the handset boots up, it will issue TFTP or HTTP(S) request to download a configuration XML file named "cfgxxxxxxxxxxx" followed by "cfgxxxxxxxxxxx.xml", where "xxxxxxxxxxx" is the MAC address of the phone, i.e., "cfg000b820102ab" and "cfg000b820102ab.xml". If downloading "cfgxxxxxxxxxxx.xml" file is not successful, the provision program will download a generic cfg.xml file. The configuration file name should be in lower case letters.

For more details on XML provisioning, please refer to the following document:

<https://documentation.grandstream.com/knowledge-base/sip-device-provisioning-guide/>

FACTORY RESET

Restore to Factory Default via LCD Menu

Warning

Restoring the Factory Default Settings will delete all configuration information on the phone. Please backup or print all the settings before you restore to the factory default settings. Grandstream is not responsible for restoring lost parameters and cannot connect your device to your VoIP service provider.

There are two methods to restore the device to the factory default settings.

1. On the handset idle screen, go to **Settings → Advanced Settings → Factory reset**.
2. In the new window, confirm the reset using the left softkey.

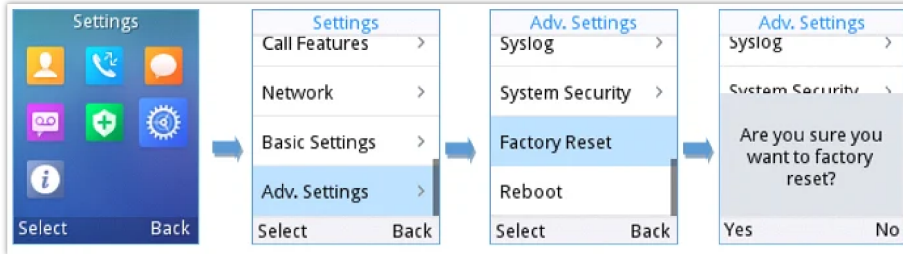

Figure 64: LCD – Confirm Factory Reset

3. Once confirming the factory reset, the device will reboot with the default factory settings.

Restore to Factory Default via the Web GUI

1. Login to Web GUI and go to **Maintenance → Tools**.
2. Click on the Start button in front of field **“Factory Reset”** to perform a Factory reset.

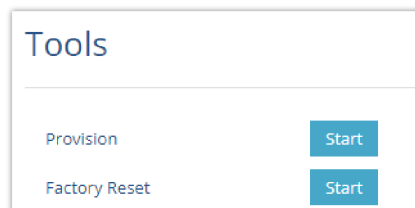

Figure 65: Web GUI – Factory Reset

3. A dialog box will pop up to confirm factory reset.
4. Click OK to restore the phone to factory settings.

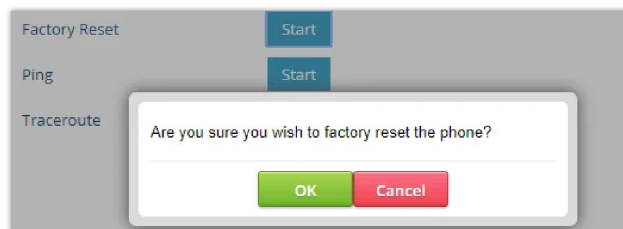

Figure 66: Web GUI – Confirm Factory Reset

CHANGE LOG

This section documents significant changes from previous firmware versions. Only major new features or major document updates are listed here. Minor updates for corrections or editing are not documented here.

Firmware Version 1.0.11.8

- No major changes

Firmware Version 1.0.11.2

- No major changes

Firmware Version 1.0.9.23

- No major changes.

Firmware Version 1.0.7.83

- No major changes.

Firmware Version 1.0.7.68

- Added support for letters with accent. [[Keypad](#)]
- Added support to differentiate rejected calls icon from missed calls. Now the rejected calls will be logged as received calls with different icon. [[Icons Description](#)]
- Added support to display contacts with no numbers in the phonebook. [[CONTACTS](#)]

Firmware Version 1.0.7.18

- No major changes.

Firmware Version 1.0.7.7

- No major changes.

Firmware Version 1.0.1.1

- This is initial version.