

IMPACT D series

Wireless DECT Headset System

IMPACT D 10 Phone II | IMPACT D 30 Phone | IMPACT D 30 USB ML | IMPACT D 10 USB ML II

User Guide

Contents

Package contents	2
Base stations with components.....	2
Headsets with components.....	2
Product overview	3
Overview of the base station.....	3
Overview of the headsets.....	5
Overview of the buttons	7
Overview of the LEDs.....	8
Setting up and connecting the base station	9
Setting up the base station.....	9
Connecting the base station to the mains power supply.....	9
Connecting the base station to a fixed line phone.....	10
Connecting the base station to a computer	12
Charging the headset.....	12
Individually adjusting the headset	13
Using the D 10 HS II headset with the ear hook.....	13
Using the D 10 HS II headset with the headband	14
Adjusting and wearing the D 30 HS headset.....	15
Configuring the headset system	16
Adjusting the headset system using the DIP switches.....	16
Adjusting the audio signal by means of the dial tone	20
Adjusting the volume of the transmission	20
Adjusting the volume of the ring tone.....	21
Adjusting the automatic audio transmission "Auto Audio"	21
Making calls using the headset	22
Adjusting the volume	22
Muting the headset's microphone.....	24
If you leave the DECT range.....	24
Calling via the fixed line phone using the headset.....	25
Calling via the computer using the headset	27
Making a conference call	29
Charging the headset and storing the headset system	31
Charging the headset.....	31
Charging the headset using the optional CH 10 headset charger.....	32
Switching the headset system off during extended non-use	32
Sharing a workplace	33
Using the headset with a third party base station (DECT-GAP telephone).....	33
Cleaning and maintaining the headset system	34
Replacing the ear pads.....	35
Replacing the headset's rechargeable battery.....	36
If a problem occurs	38
Specifications	40

Package contents

The scope of delivery includes – depending on the product purchased – a base station and/or a headset with corresponding components.

Base stations with components

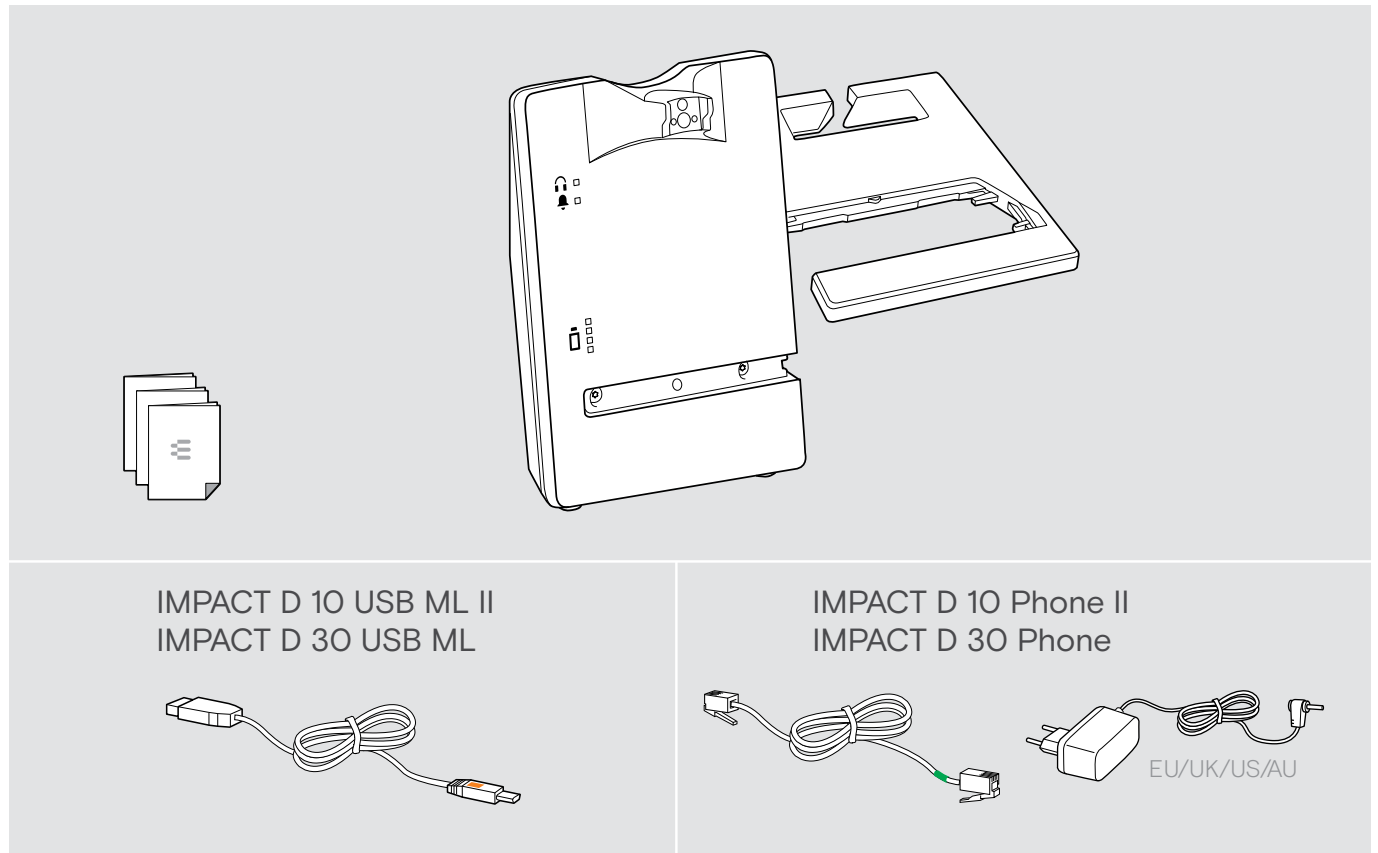

Headsets with components

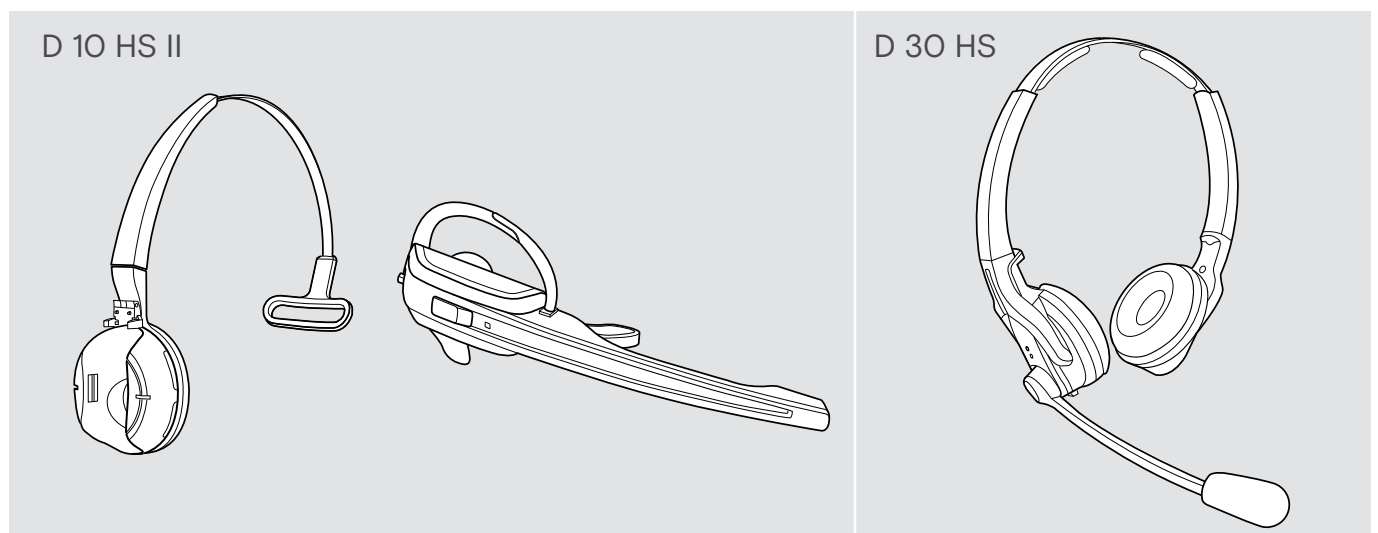

For safety instructions, consult the Safety Guide.



A list of accessories can be found on the product page at www.eposaudio.com.

Product overview

Overview of the base station

Overview of the front

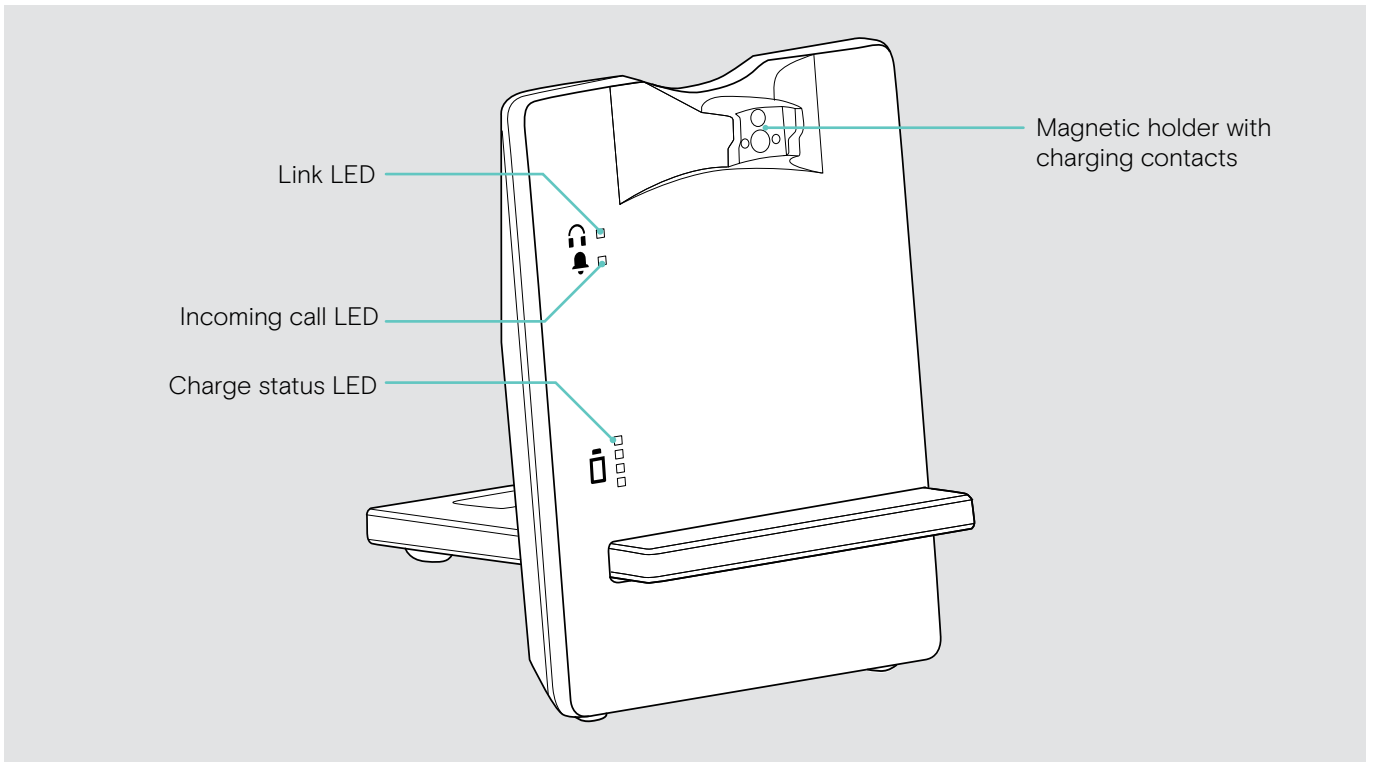

Overview of the rear – Phone version

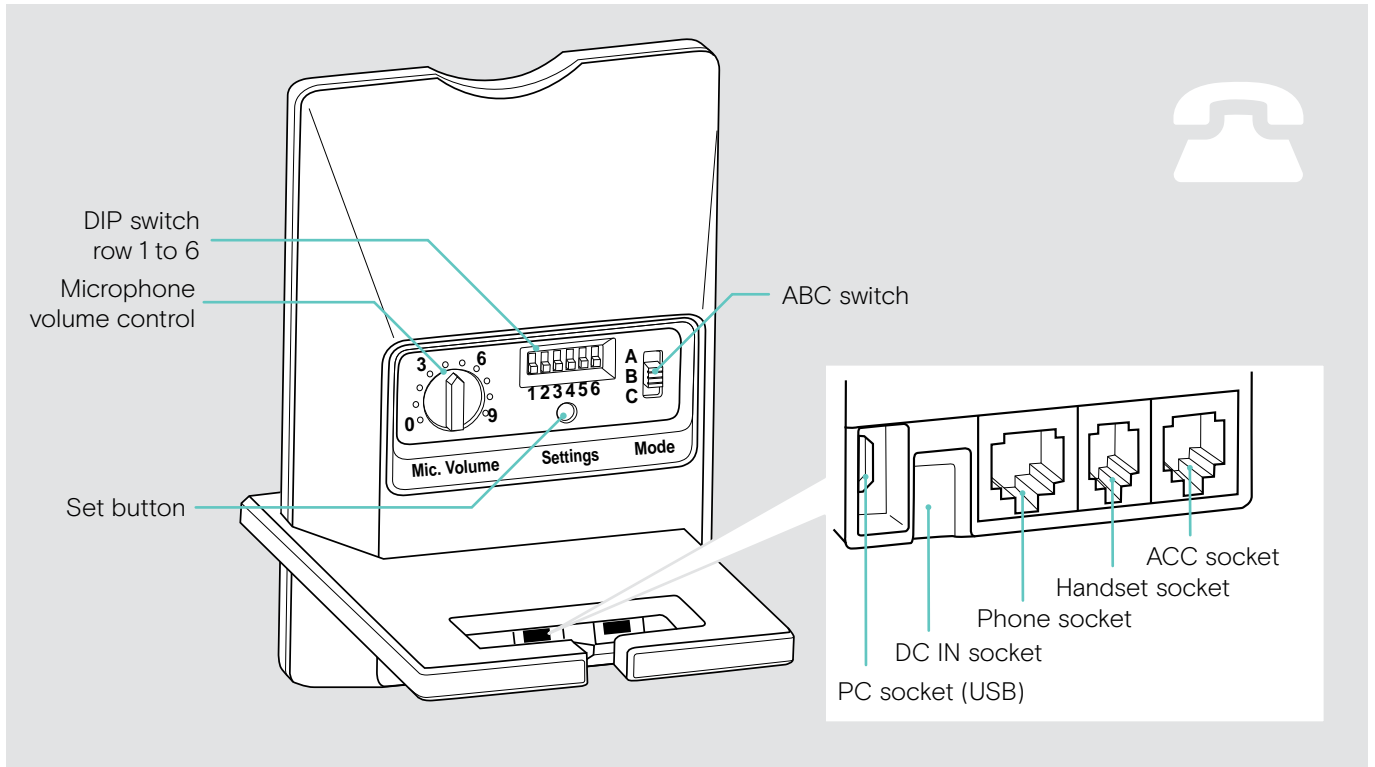

Overview of the rear – USB version

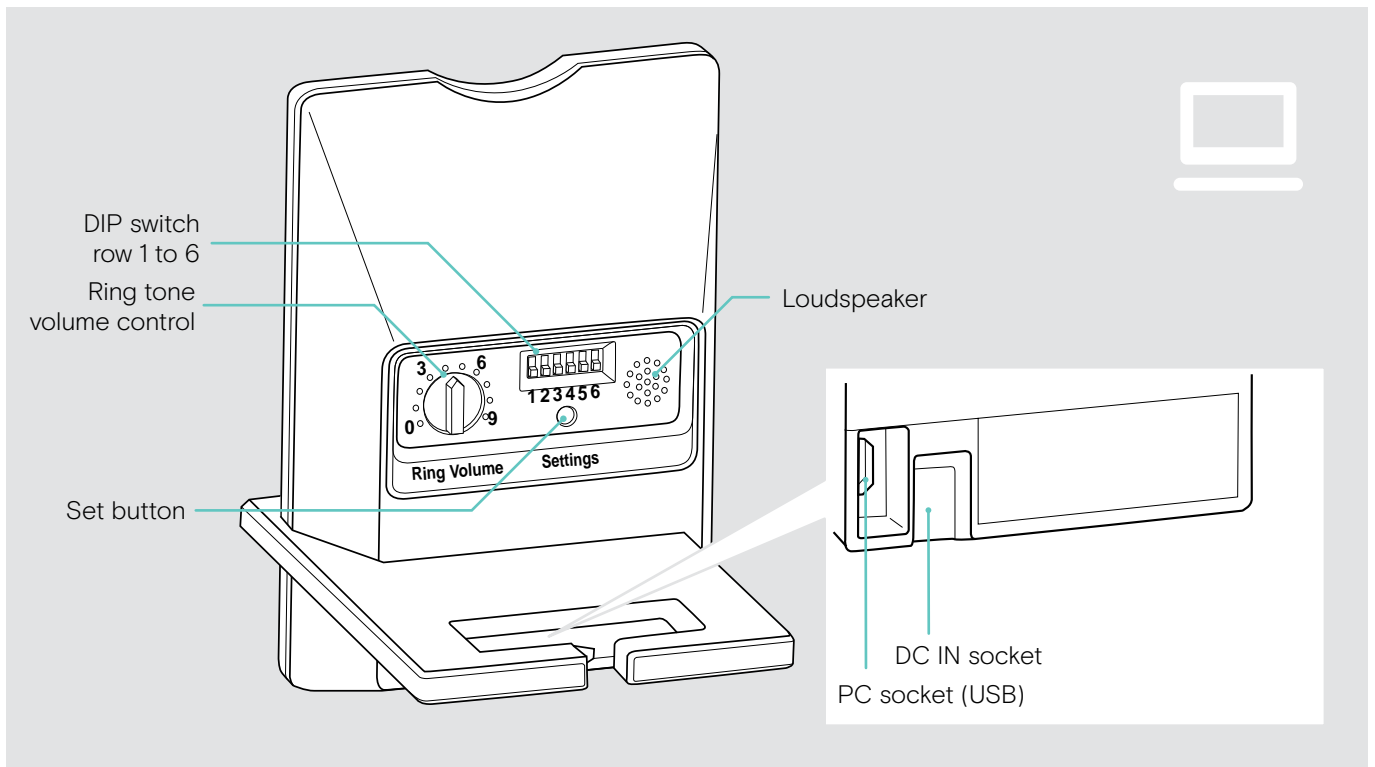

Overview of the headsets



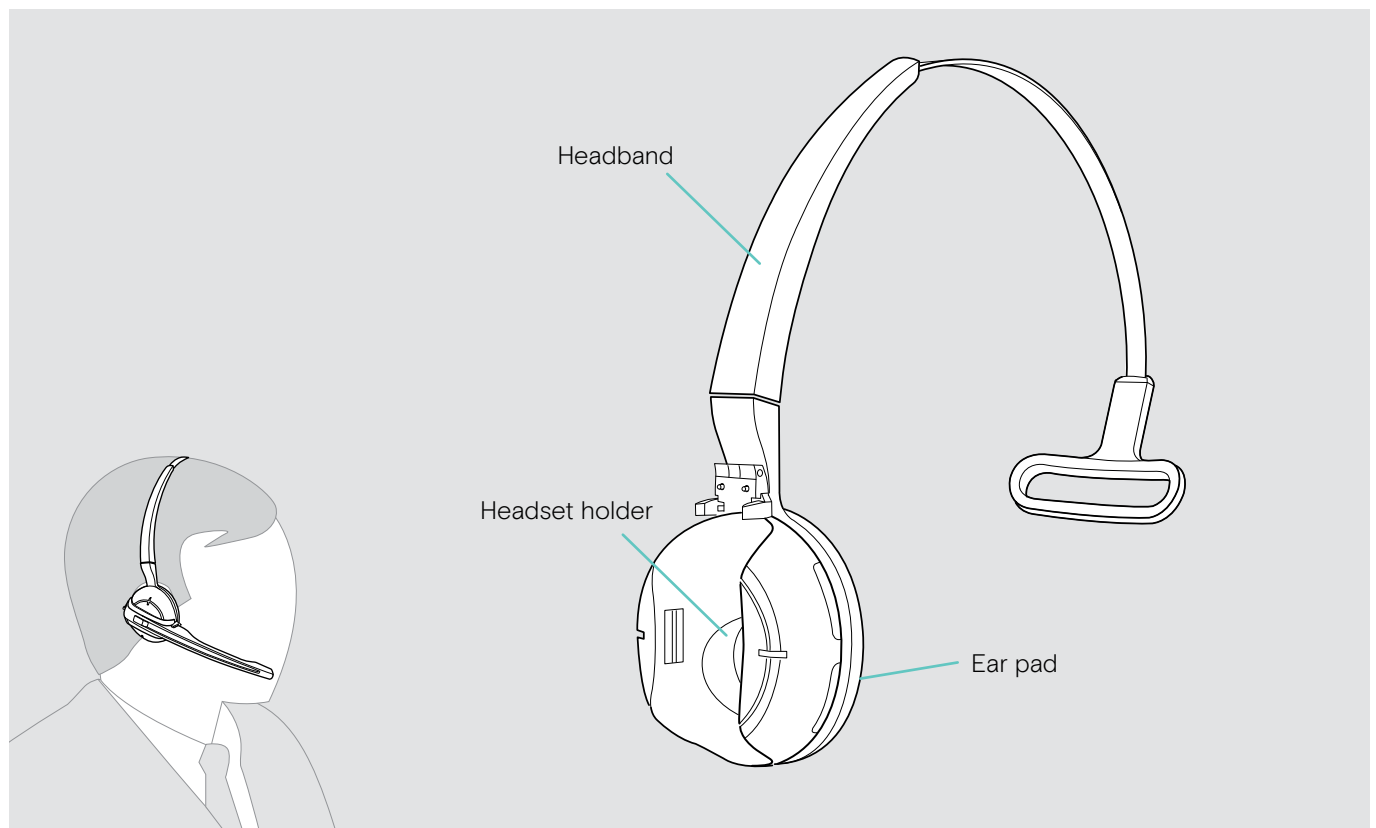
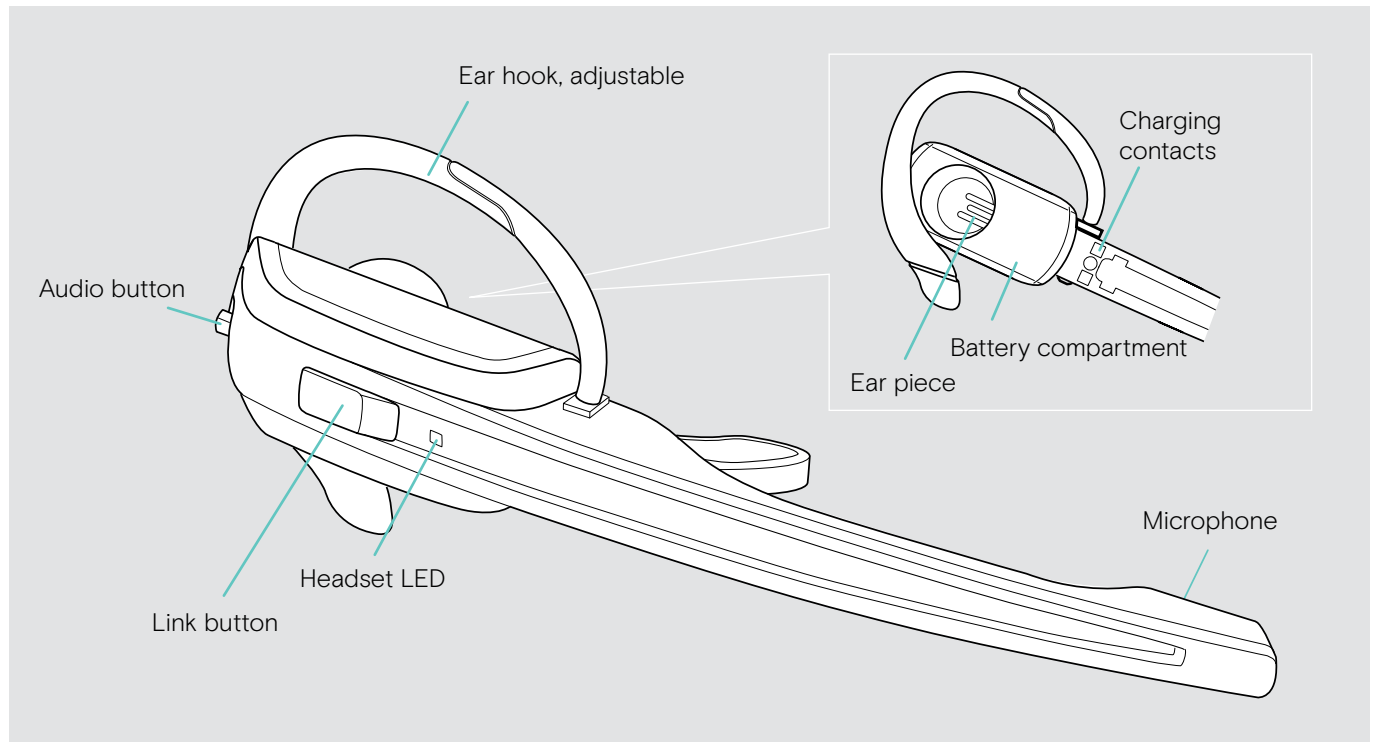



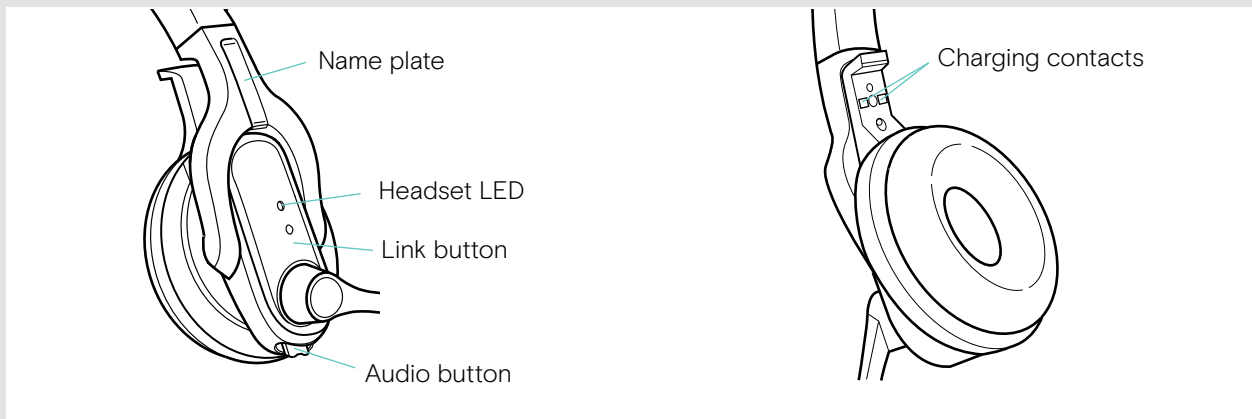
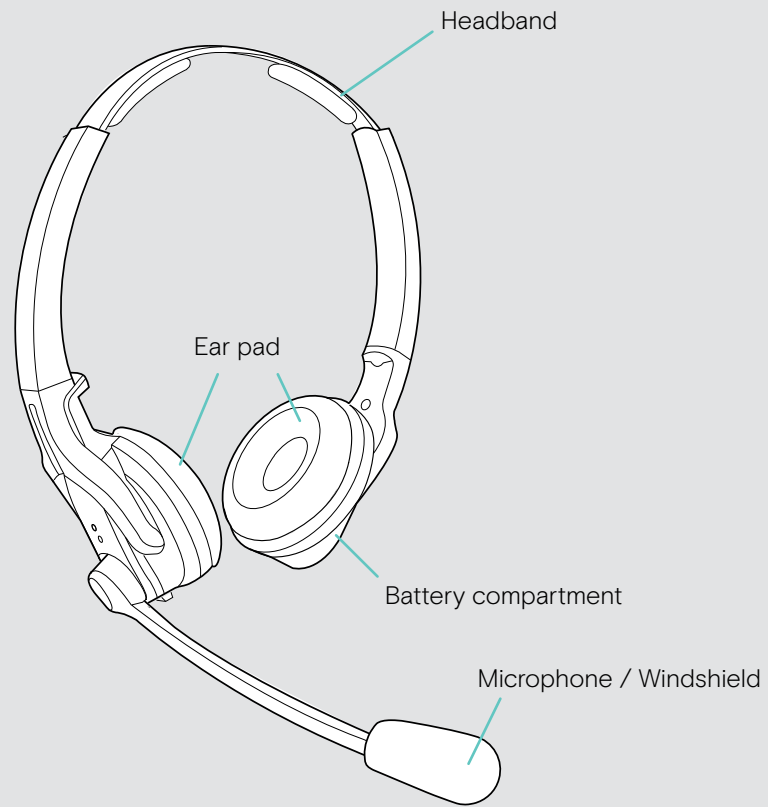

Overview of the D 10 HS II

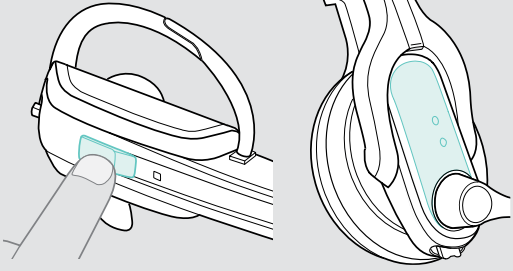

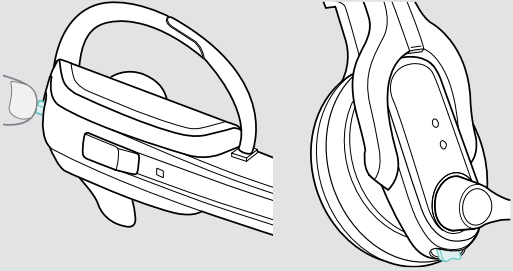
Overview of the D 30 HS











Overview of the buttons





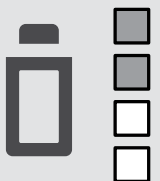
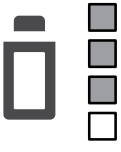

Functions	Page
<p data-bbox="316 253 448 280">Link button</p> 	 Establishes/disconnects the link between headset and base station 22
	 Accepts/ends a call 22
<p data-bbox="304 584 459 611">Audio button</p> 	 Switches the headset on/off 32
	 Adjusts the ring tone volume and the volume of the acoustic signals or the audio volume 22
	 Mutes the microphone/unmutes the microphone 24
	 + Link button: Changes the direction of the volume up/down function of the Audio button 23
 + Link button: Special pairing mode 33	

Overview of the LEDs

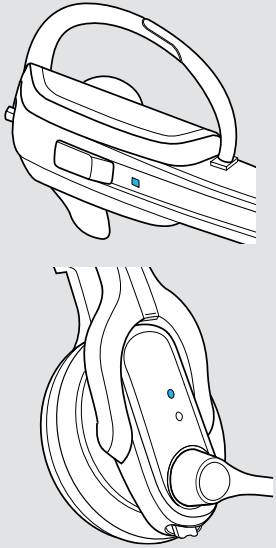
Overview of the base station LEDs

Base station	LED	Meaning
Link LED 		Active link to the headset
		No link to the headset
		Headset is muted
		Standby mode, headset is within the range of the base station, but no audio link
Incoming call LED 		Incoming call
Charge status LED 		LED segment 1 flashes: Rechargeable battery is almost flat
		LED segments 1 – 4 are lit: Rechargeable battery is charged

Overview of the headset LED

Headset	LED	Meaning
		Headset is being charged in the base station
		Active link to base station
		Rechargeable battery is almost flat
		<ul style="list-style-type: none"> Standby mode or headset is switched off Headset's rechargeable battery is fully charged
		<ul style="list-style-type: none"> Special pairing mode Direction of the volume up / down function of the Audio button is being changed Pairing of an additional headset with the base station Conference call

Setting up and connecting the base station



Setting up the base station

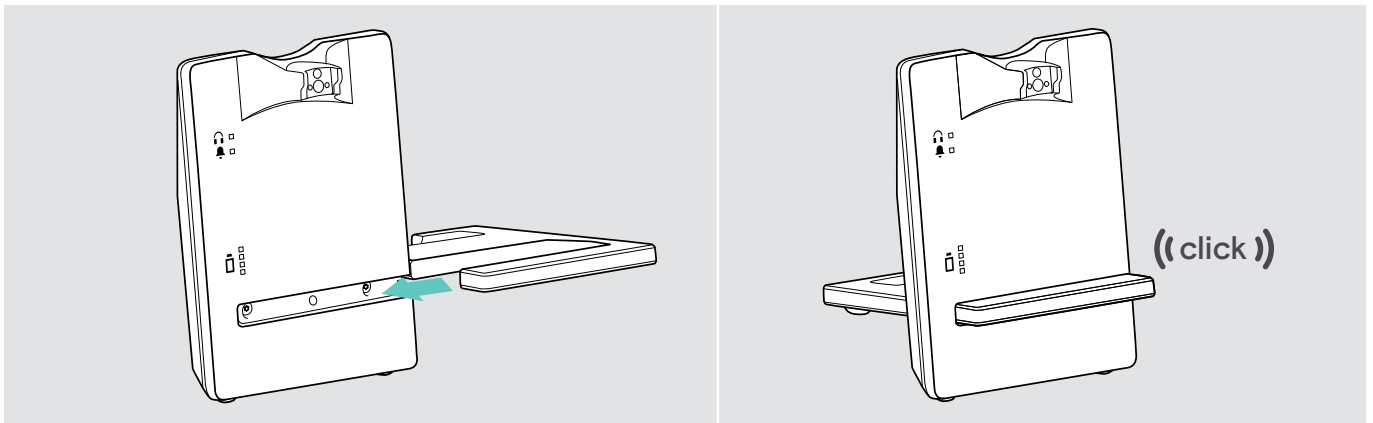

- ▶ Insert the holder into the recess of the base station.
- ▶ Place the base station at a minimum distance of 15 cm from the fixed line phone.

Connecting the base station to the mains power supply

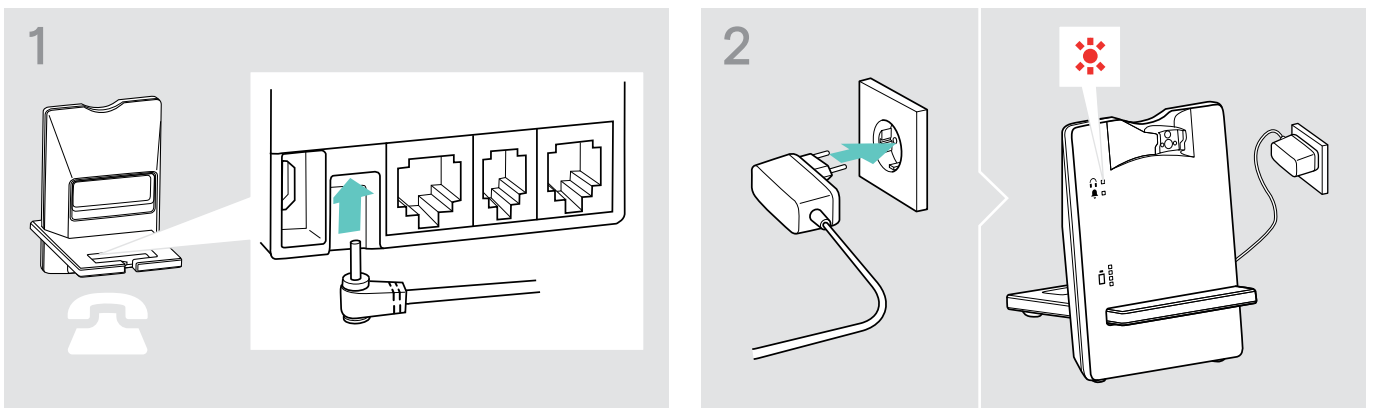

- ▶ Connect the plug of the power supply unit to the DC IN socket (marked yellow).
- ▶ Connect the power supply unit to a wall socket. The Link LED lights up red.

Disconnecting the base station from the mains power supply

- ▶ Unplug the power supply unit from the wall socket, if the product is not used for extended periods of time.

Connecting the base station to a fixed line phone

- ▷ Check which connection possibility is best suited for your telephone.
- ▷ Follow the instructions in the corresponding chapter.

Connection possibilities

- Connection to a fixed line phone without headset socket **A**
- Connection to a fixed line phone with headset socket **B**
- Connection to an optional mechanical handset lifter **C**
- Connection to an optional electronic hook switch control (EHS) **D**



Connecting the base station to a fixed line phone without headset socket

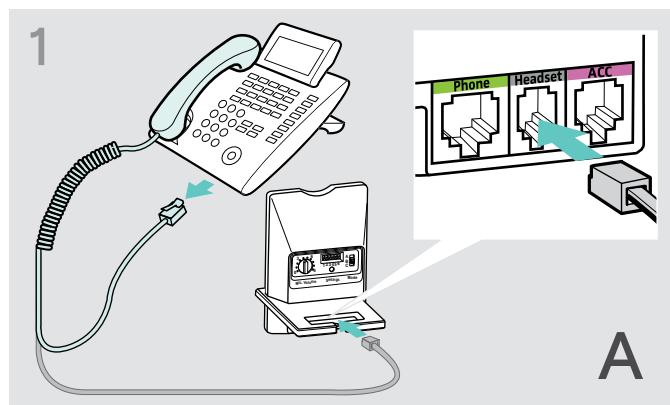

- ▷ Disconnect the handset cable from the telephone and connect it to the **Handset** socket (marked gray) on the base station.

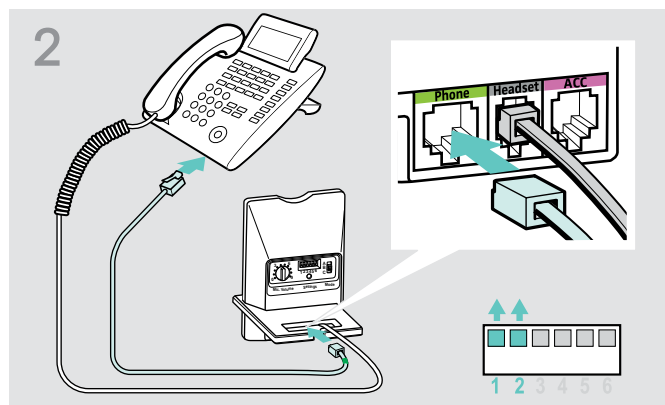

- ▷ Connect the telephone cable to the handset socket on the telephone and to the **Phone** socket (marked green) on the base station.
- ▷ Use a pointed object (e.g. a ball pen) to set the DIP switches **1** and **2** to the position shown.

Connecting the base station to a fixed line phone with headset socket

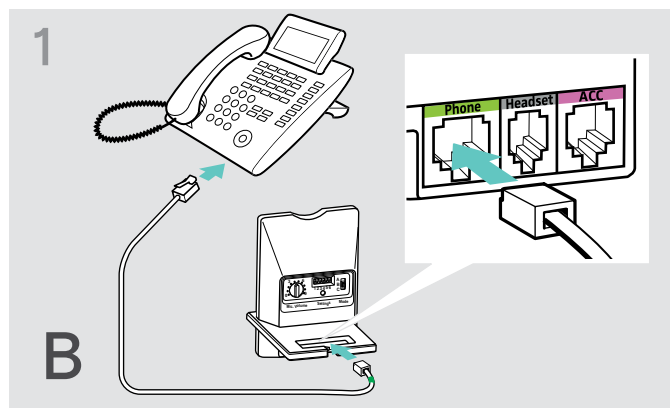

- ▷ Connect the telephone cable to the headset socket on the telephone and to the **Phone** socket (marked green) on the base station.

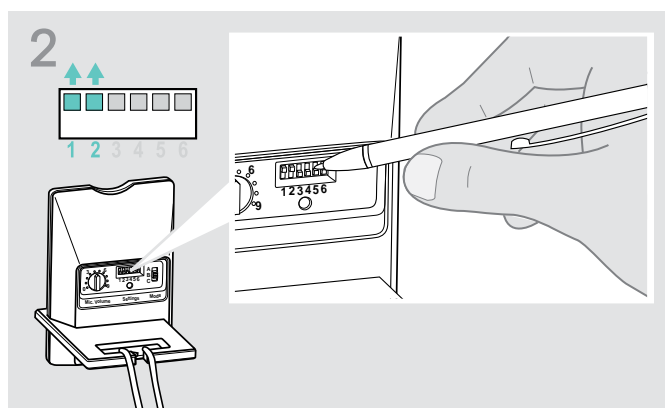

- ▷ Use a pointed object (e.g. a ball pen) to set the DIP switches **1** and **2** to the position shown.

Connecting the base station to an optional mechanical handset lifter

The EPOS HSL 10 II mechanical handset lifter is an optional accessory available from your EPOS partner. The handset lifter allows you to answer calls even when you are away from your desk.

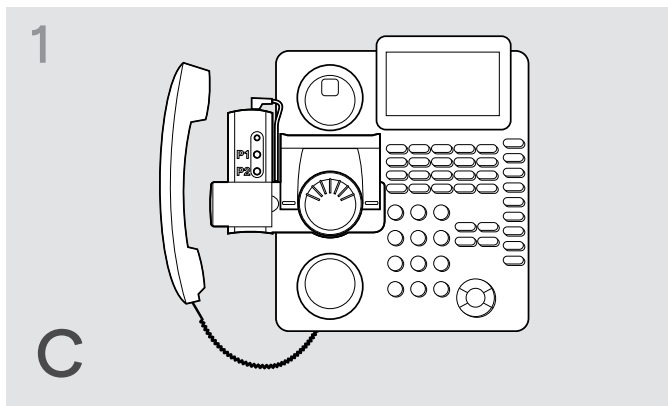

- ▶ Connect the base station to the fixed line phone as described in chapter A.
- ▶ Connect the handset lifter to the ACC socket on the base station.

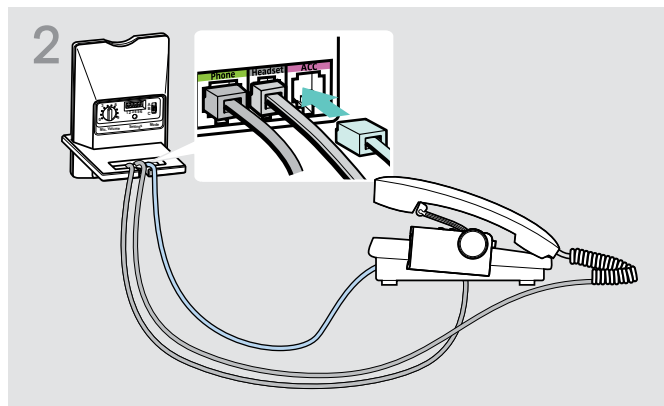

- ▶ Connect the handset lifter to the fixed line phone. For more information, refer to the instruction manual of the HSL 10 II handset lifter.

Connecting the base station to an optional electronic hook switch control (EHS)

The necessary EHS connection cables as well as adapter cables for manufacturer specific standards are available from your EPOS partner.

For further information concerning corresponding phones and cables visit www.eposaudio.com/compatibility. Quick Guides are supplied with the cables or can be found on the product page on our website at www.eposaudio.com.

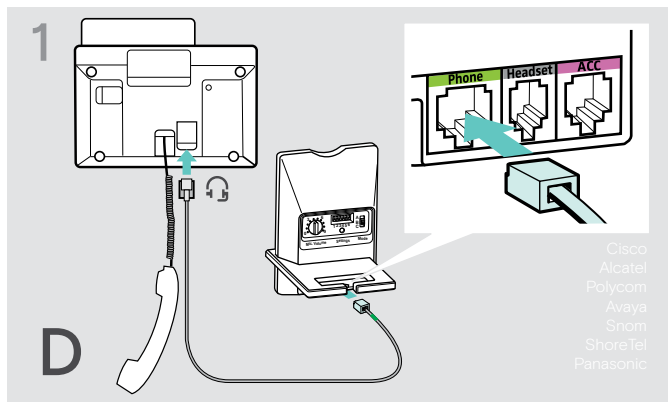

- ▶ Connect the base station to the fixed line phone as shown in the cable Quick Guide.

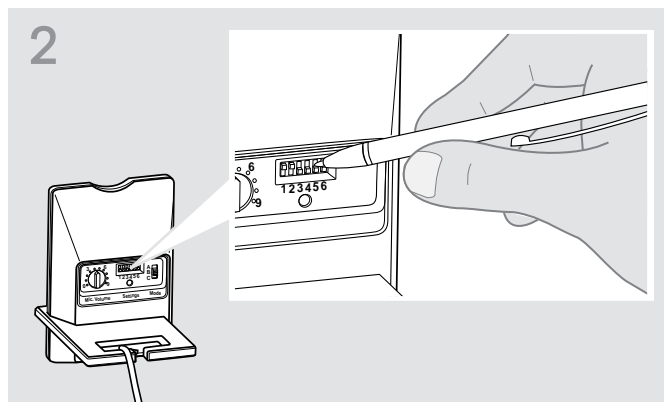

- ▶ Use a pointed object (e.g. a ball pen) to set the DIP switch to the position shown in the cable Quick Guide.

Connecting the base station to a computer

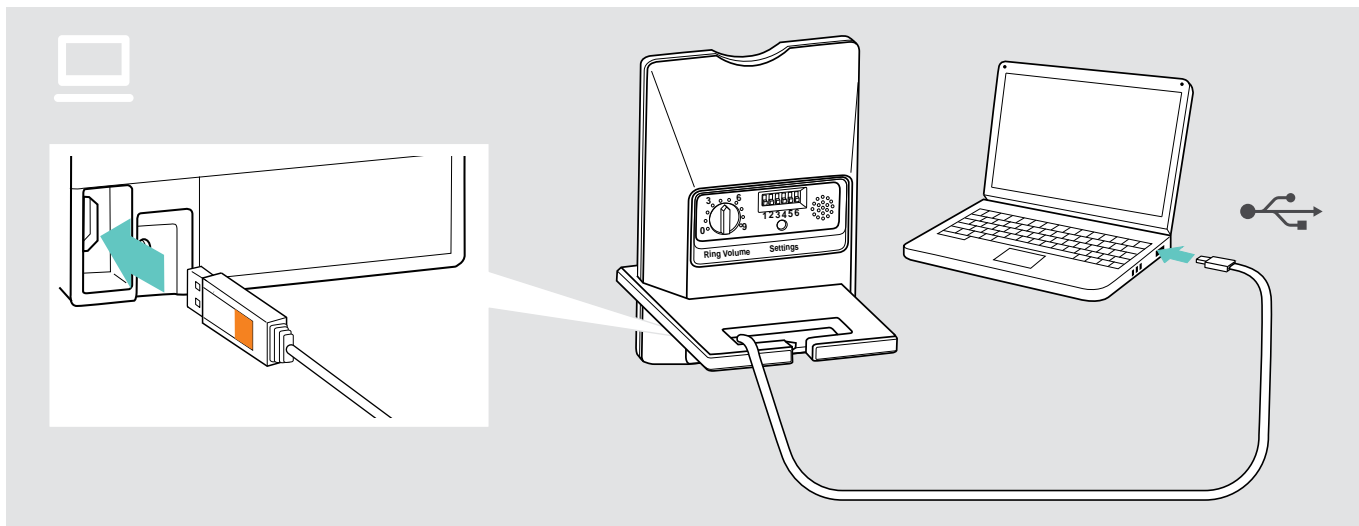

- ▶ Connect the USB cable to the **PC** socket (marked orange) on the base station and to a USB socket of your computer. The operating system detects the USB audio device and installs the necessary drivers.

Installing EPOS software

The EPOS software allows you to add value to your EPOS products. **EPOS Connect** enables easy set-up, configuration and update of your IMPACT D series.



- ▶ Download the software from www.eposaudio.com/connect.
 - ▶ Install the software. To install the software, you need administrator rights on your computer. If necessary, contact your IT department.
- To make calls via the computer:
- ▶ Install a softphone (VoIP Software), such as Skype for Business or ask your admin for support.

Charging the headset

- ▶ Charge the rechargeable battery for at least 20 minutes without interruption before using it for the first time. A complete charging process takes about 60 minutes.

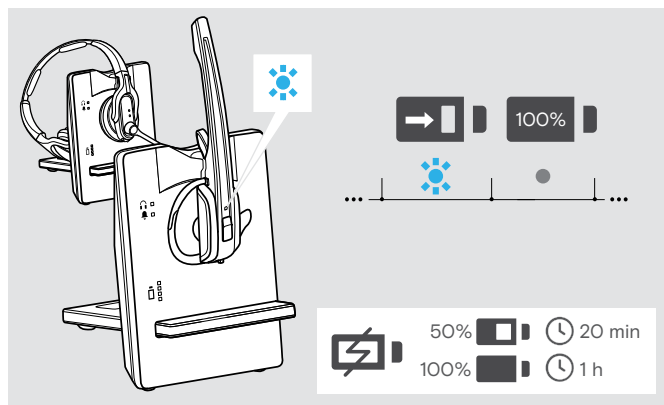
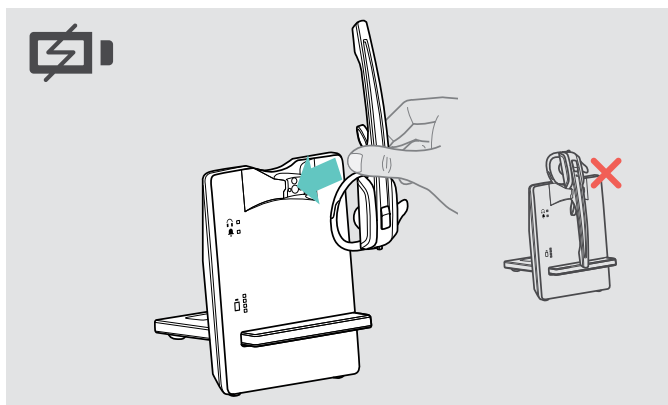

- ▶ Place the headset into the magnetic holder of the base station.

The Headset LED lights up blue and the rechargeable battery is being charged (see page 31).

During the first charging process, it may take up to 5 minutes until the Headset LED lights up blue.

Individually adjusting the headset

Using the D 10 HS II headset with the ear hook

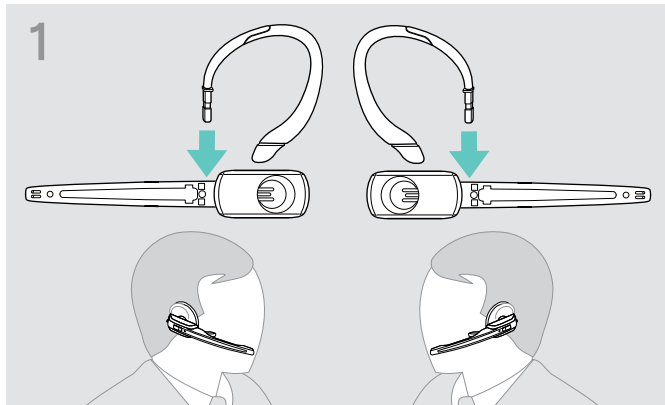

▷ Change wearing side - if required.

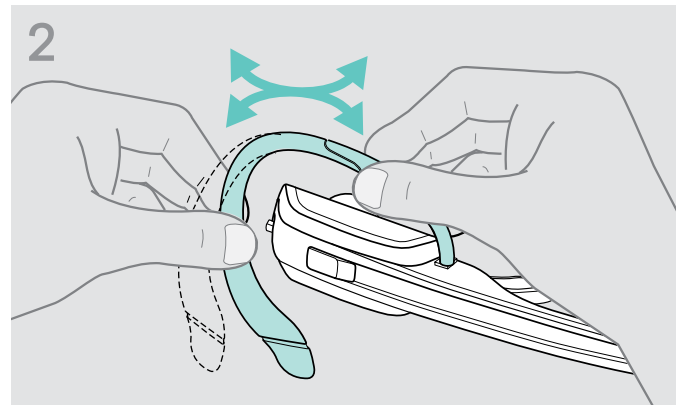

▷ Pre-shape the ear hook by bending it slightly.

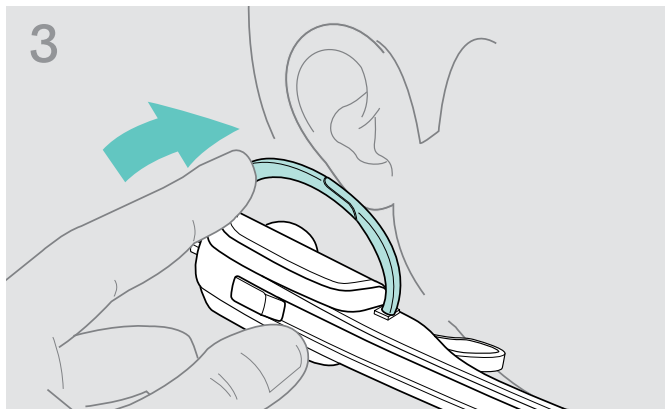

▷ Place the ear hook around your ear.

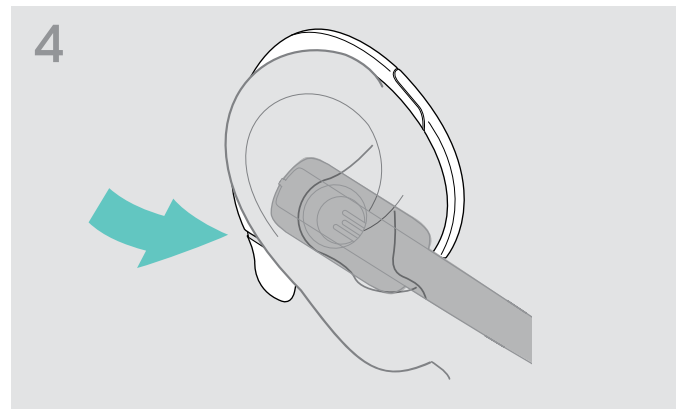

▷ Bend the flexible ear hook so that the headset sits comfortably and securely on your ear.

Using the D 10 HS II headset with the headband

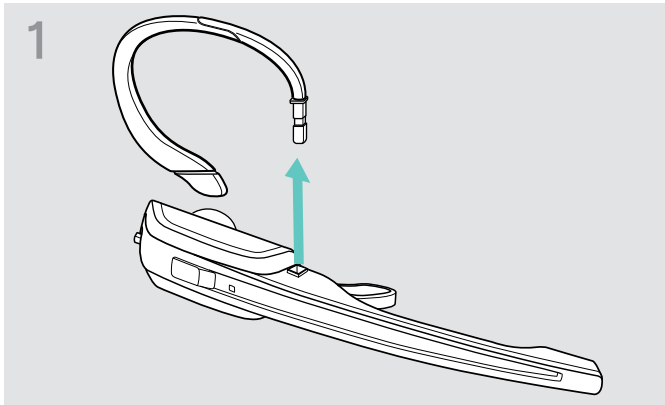

▷ Remove the ear hook by carefully pulling it upwards.

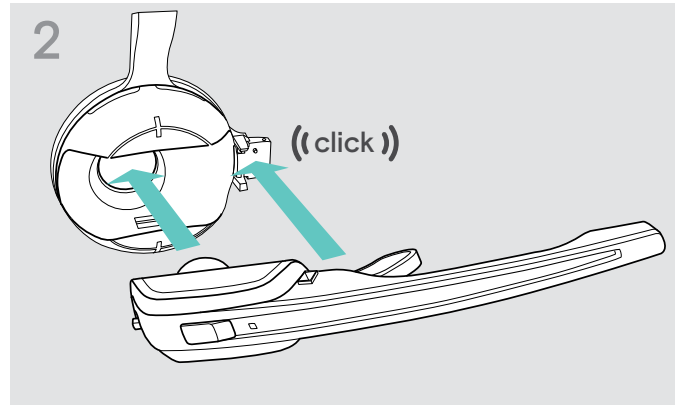

▷ Attach the headset to the headset holder of the headband.

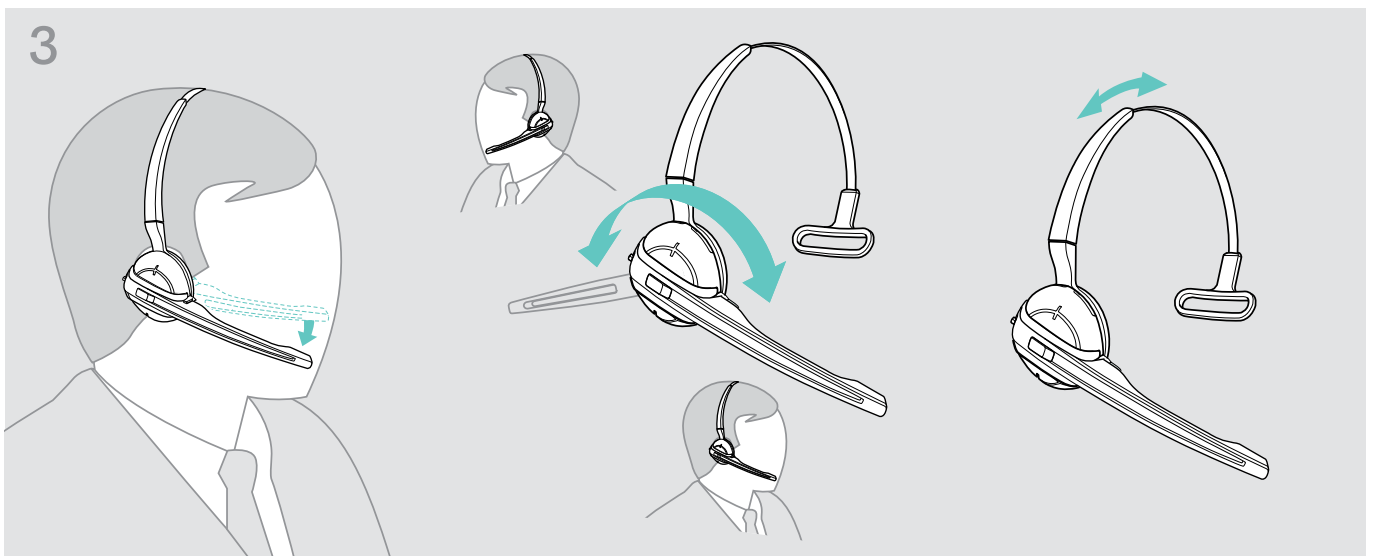

▷ Rotate the microphone boom and adjust the headset so that the ear pad rests comfortably on your right or left ear.

Adjusting and wearing the D 30 HS headset

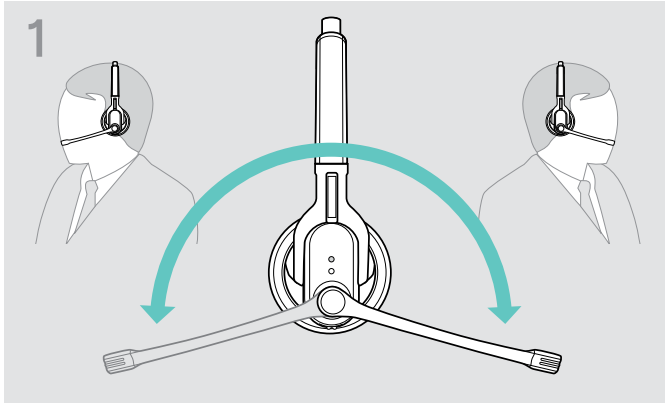

▷ Rotate the microphone boom.

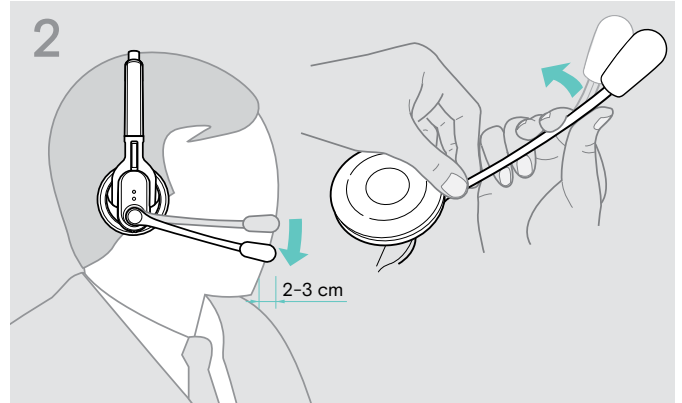

▷ Bend the microphone boom so that the microphone is about 0.8" (2 cm) from the corner of your mouth.

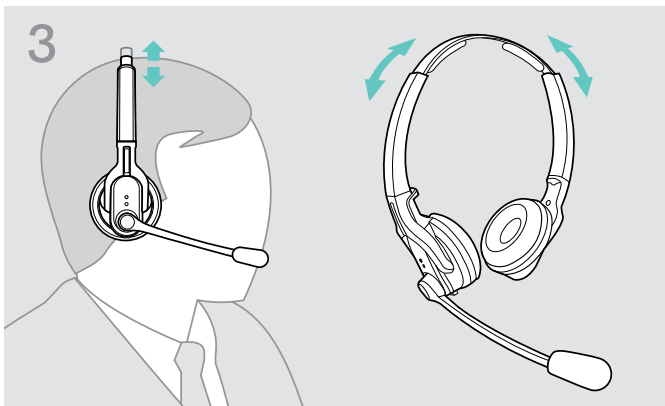

▷ Adjust the headset so that the ear pads rest comfortably on your ears.

Configuring the headset system

Adjusting the headset system using the DIP switches

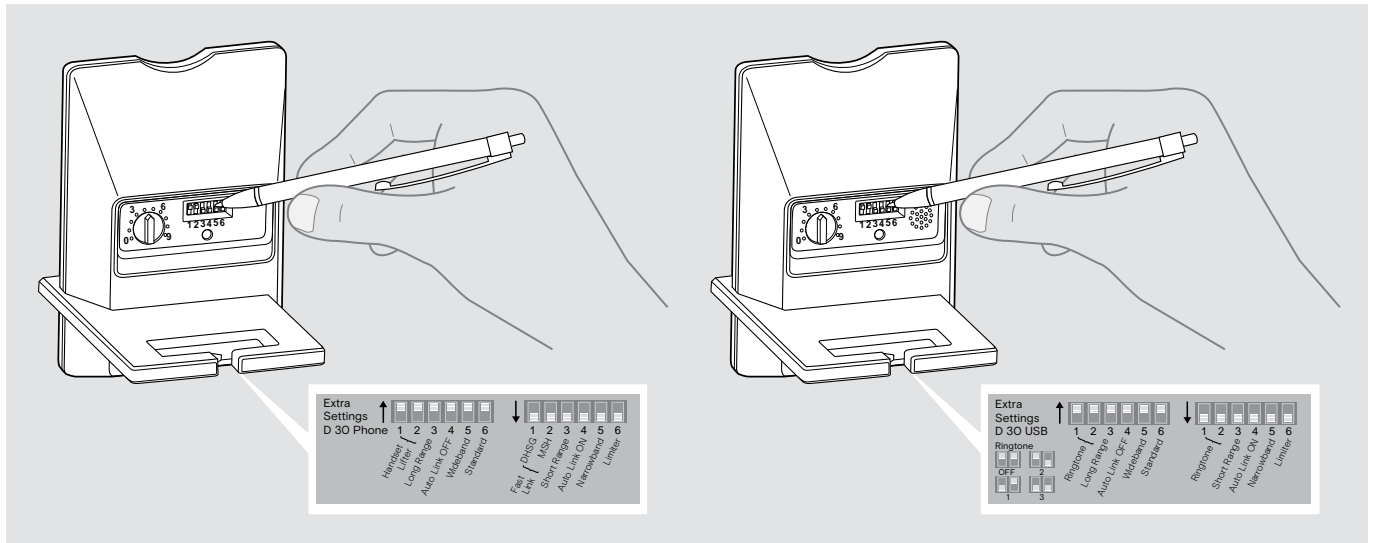

► Use a pointed object (e.g. a ball pen) to set the DIP switches to the desired position.

Configuring the handset lifter/hook switch – DIP switches 1 and 2

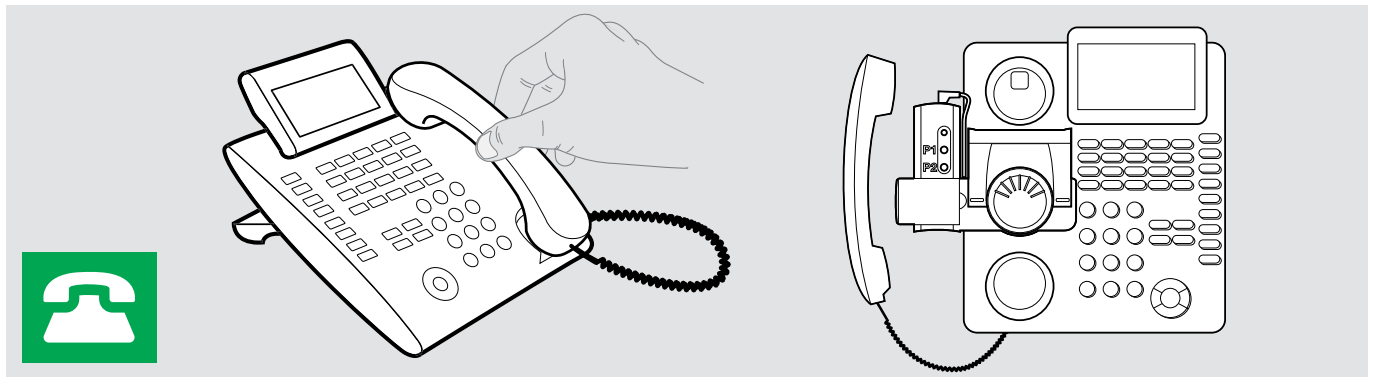

Switch position	Function
<p>1 2 3 4 5 6</p>	<p>Manual operation Lifts/hangs up the handset manually or using the handset lifter HSL 10 II.</p>
<p>1 2 3 4 5 6</p>	<p>Electronic hook switch (DHSG standard) Call control via the headset system. For faster link establishment, see Fast Link.</p>
<p>1 2 3 4 5 6</p>	<p>Electronic hook switch (MSH standard) Call control via the headset system.</p>
<p>1 2 3 4 5 6</p>	<p>Fast Link for DHSG standard and HSL 10 II handset lifter Recommended for frequent callers. Shorter battery life. Fast link establishment without delay due to hidden link to the base station.</p>

Adjusting the ring tones of the base station – DIP switches 1 and 2

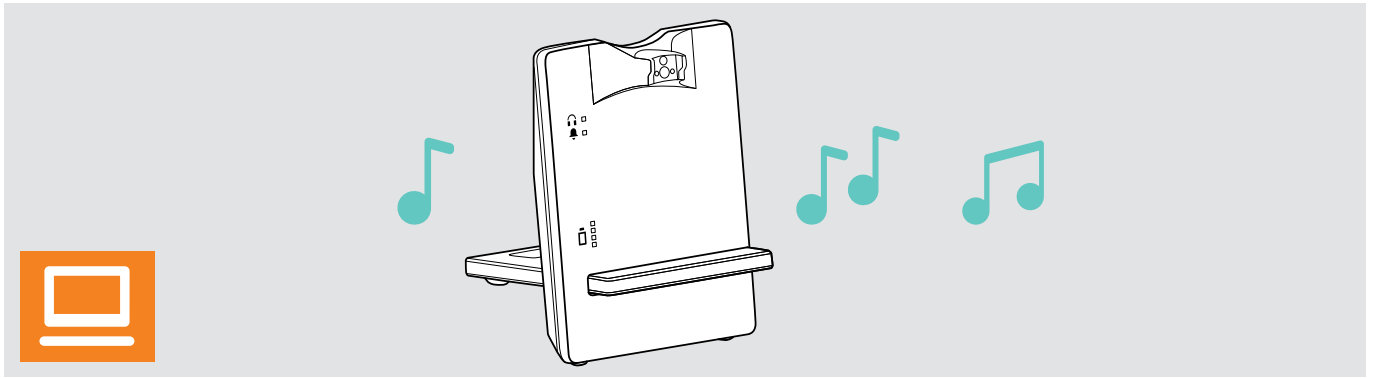

Switch position	Function
 1 2 3 4 5 6	Ring tone is off
 1 2 3 4 5 6	Ring tone 1 is activated
 1 2 3 4 5 6	Ring tone 2 is activated
 1 2 3 4 5 6	Ring tone 3 is activated

Adjusting the radio range – DIP switch 3

If many DECT systems are operated in a confined space, interference can occur. In this case, you should change the radio range.



Switch position	Function
 1 2 3 4 5 6	Standard radio range
 1 2 3 4 5 6	Reduced radio range Use this setting in order to avoid interference with other DECT systems Range of approx. 10 m indoors

Automatically establishing the wireless link between headset and base station (Auto Link) – DIP switch 4



Switch position

Function

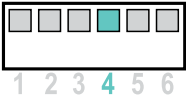

Manual link establishment

When taking the headset out of the base station, you have to manually establish the wireless link between headset and base station.

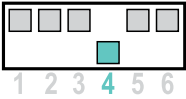

Automatic link establishment – Auto Link

When taking the headset out of the base station, a wireless link is automatically established between headset and base station.

Switching between wideband and narrowband audio transmission – DIP switch 5

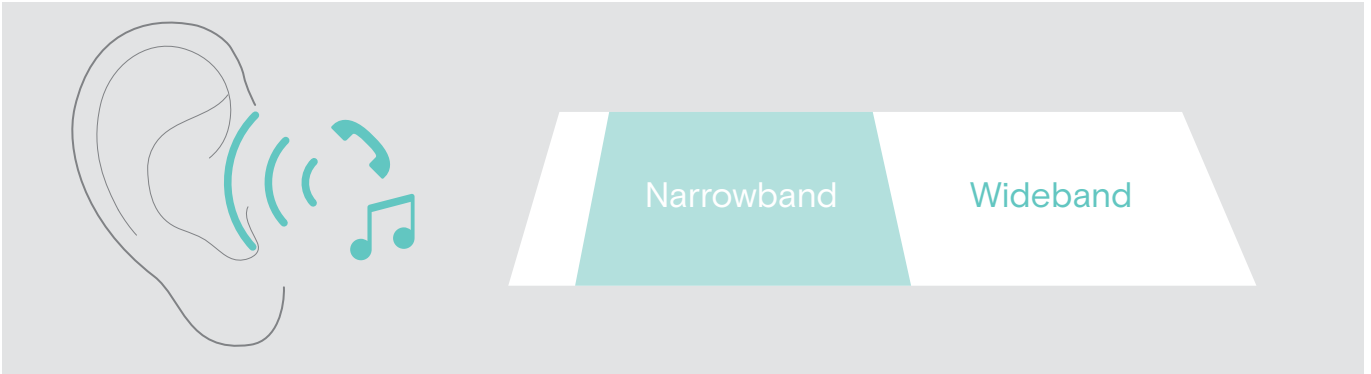

Switch position

Function

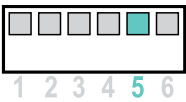

Wideband audio transmission

Automatic frequency adjustment of wideband and narrowband calls. Wideband audio transmission is e.g. supported by Skype and gives high speech quality.

Battery life: 8 hours

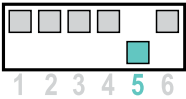

Narrowband audio transmission

Battery life: 12 hours

Limiting the volume – DIP switch 6

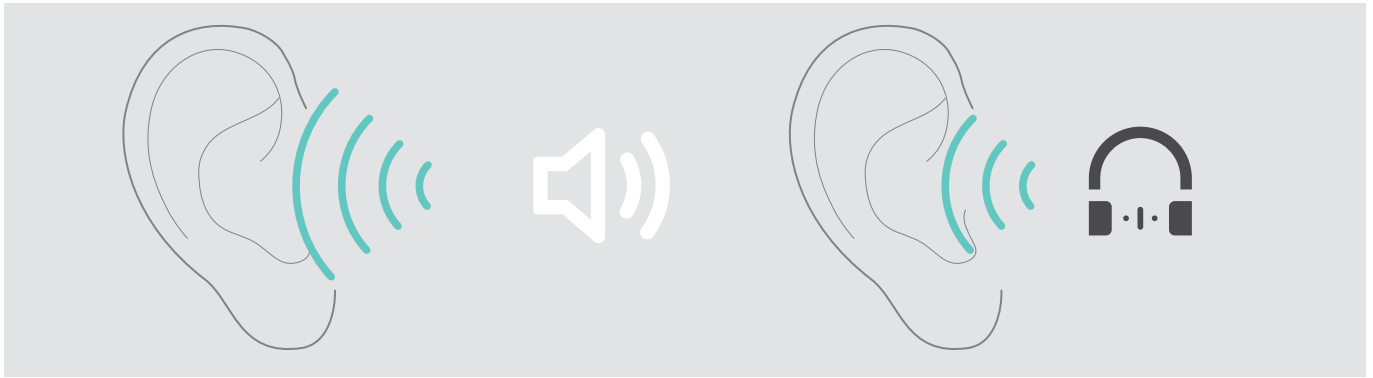

Switch position	Function
<p>1 2 3 4 5 6</p>	<p>Standard limitation</p>
<p>1 2 3 4 5 6</p>	<p>Limited volume (country specific)</p> <ul style="list-style-type: none"> • AU version: in compliance with Directive AS/ACIF G616:2006 • EU and US version: in compliance with Directive 2003/10/EC

Adjusting the audio signal by means of the dial tone



▷ Put on the headset.

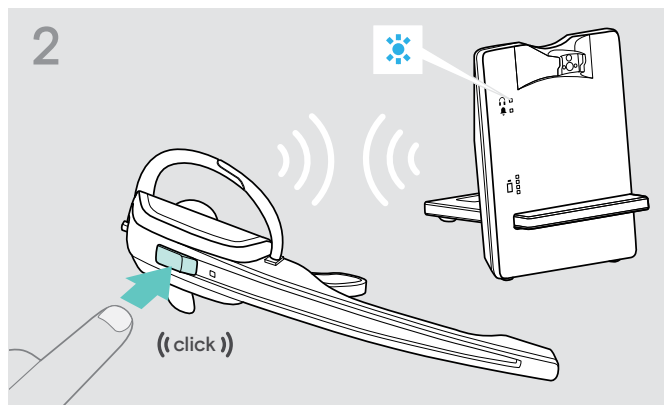

▷ Press the Link button on the headset.
The Link LED on the base station lights up blue.

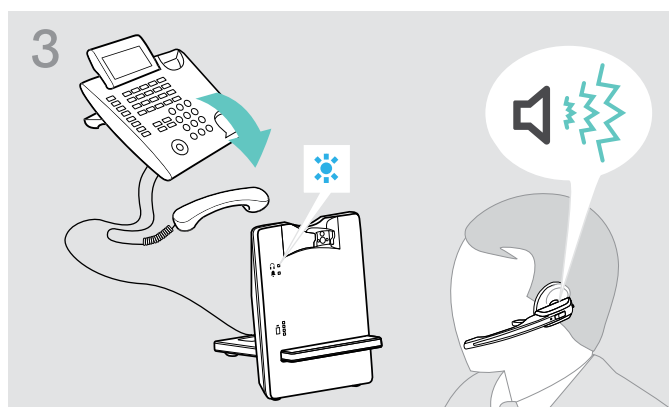

▷ Lift the handset.
You hear a dial tone.

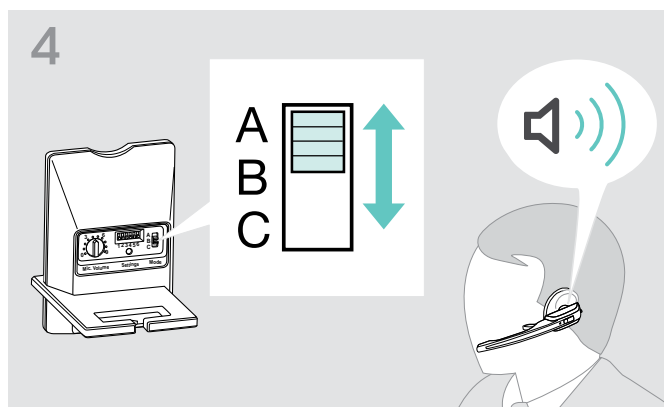

▷ Set the ABC switch to the position A, B or C so that you can hear a clear dial tone in the headset.

Adjusting the volume of the transmission

Adjusting the microphone volume of the call transmission

By default, the microphone volume control is set to position 4. This setting is suitable for most telephones.

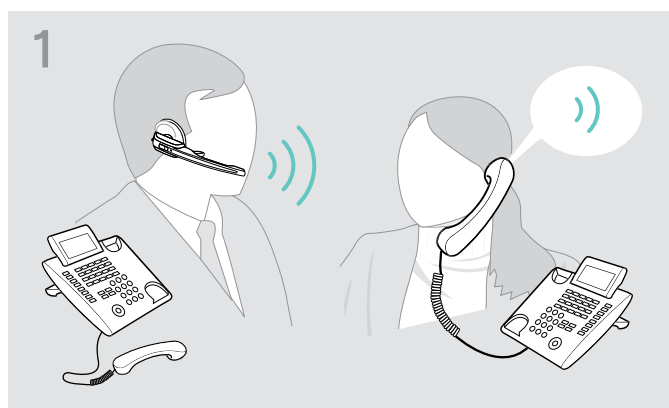

▷ Make a call to someone who will help you find the correct sensitivity setting for your microphone (see page 17).

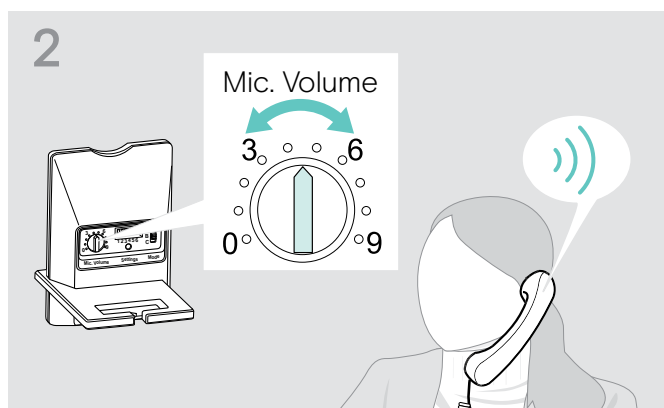

▷ Turn the microphone volume control so that the other party can hear you at a comfortable level.

Adjusting the microphone volume of the USB transmission

- ▷ Activate this function in order to be able to optimally use the microphone and, via your operating system.
- ▷ Adjust the microphone sensitivity so that the other party can hear you at a comfortable level (see the Help function of your operating system).

Adjusting the volume of the ring tone

Adjusting the headset's ring tone volume and the volume of the acoustic signals

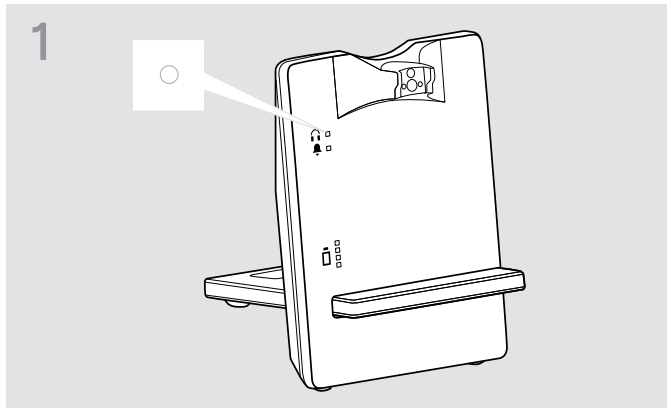

▷ Make sure that the headset is in standby mode (the Link LED on the base station is off). If necessary, press the Link button on the headset.

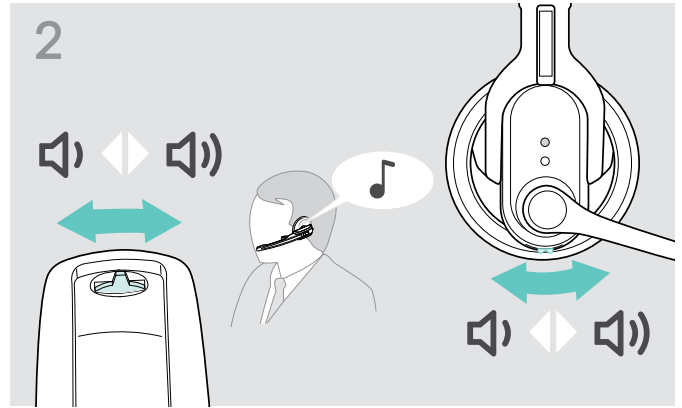

▷ Move the Audio button as shown in the diagram, to adjust the volume. When the minimum or maximum volume is reached, you hear a double beep in the headset.

Adjusting the ring tone volume of the base station

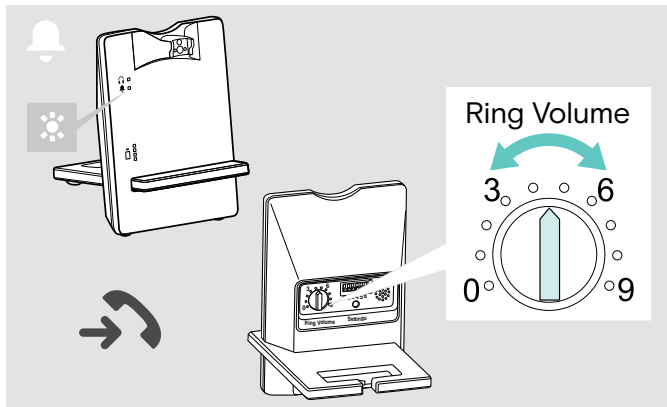

▷ Turn the volume control to reduce or increase the ring tone volume.



Adjusting the automatic audio transmission “Auto Audio”

With the “Auto Audio” function activated and in the case of a USB connection, the audio signals – e.g. from Windows® Media Player® or iTunes® – are automatically transmitted to the headset.

When you receive a call, the audio transmission stops and you hear for example the ring tone. The “Auto Audio” function is activated by default.

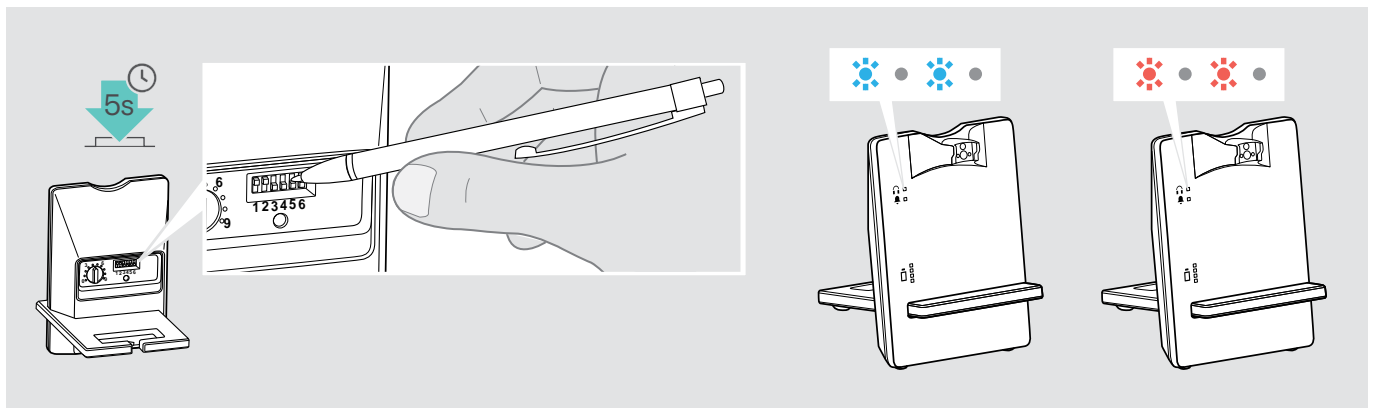

Activating the “Auto Audio” function

▷ Use a pointed object to press the Set button for approx. 5 seconds. The Link LED rapidly flashes blue several times.

Deactivating the “Auto Audio” function

▷ Use a pointed object to press the Set button for approx. 5 seconds. The Link LED rapidly flashes red several times.

Making calls using the headset

Adjusting the volume



CAUTION

Hearing damage due to high volumes!

Listening at high volume levels for long periods can lead to permanent hearing defects.

- ▷ Set the volume to a low level before putting on the headset.
- ▷ Do not continuously expose yourself to high volumes.

Adjusting the volume of the audio signal

You can adjust the volume of the audio signal by means of the dial tone or during a call.

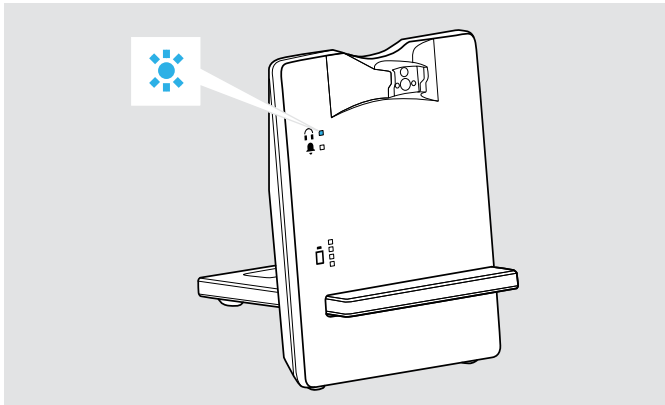

- ▷ Make sure that a link is established between headset and base station (the Link LED on the base station lights up blue).
If necessary, press the Link button on the headset.

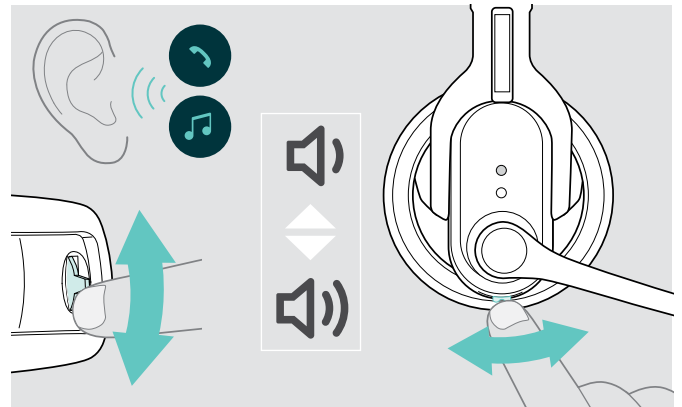

- ▷ Move the Audio button as shown in the diagram, to adjust the volume.
When the minimum or maximum volume is reached, you hear a double beep in the headset.

Changing the direction of the volume up/down function

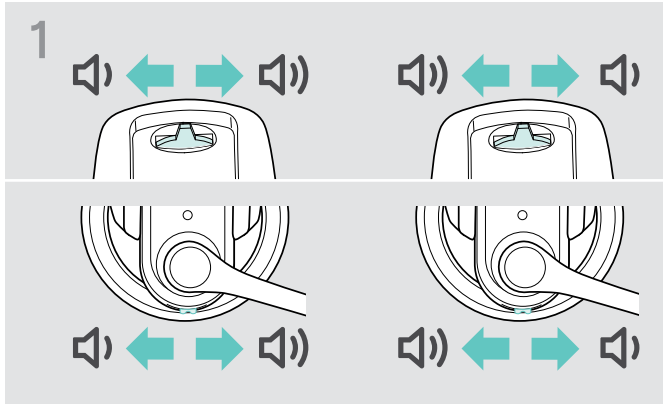

▷ On the Audio button, check which direction is assigned “volume down”.

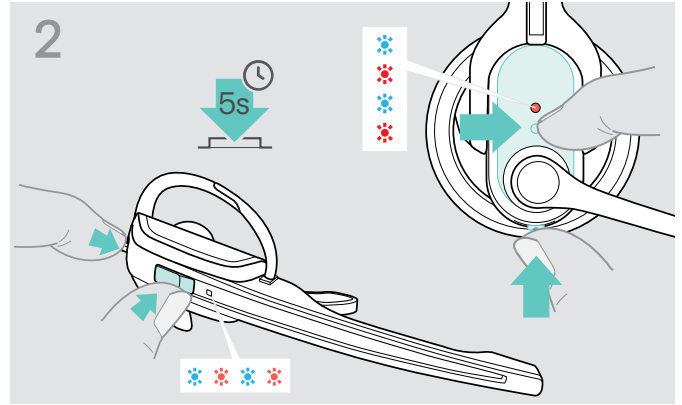

▷ Simultaneously press and hold the Link button and the Audio button for 5 seconds. The Headset LED alternately flashes blue/red.

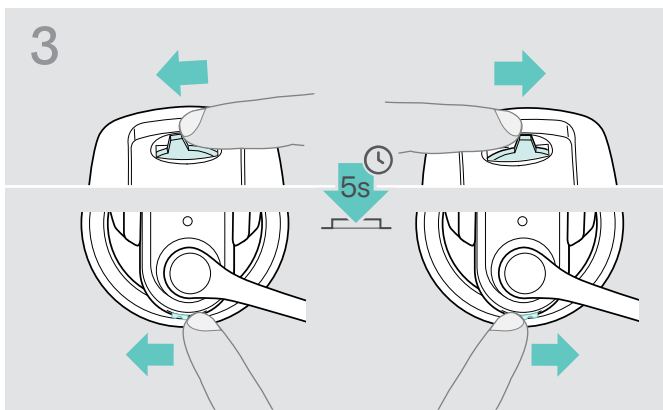

▷ Push the Audio button in the direction “volume down” until the Headset LED goes off.

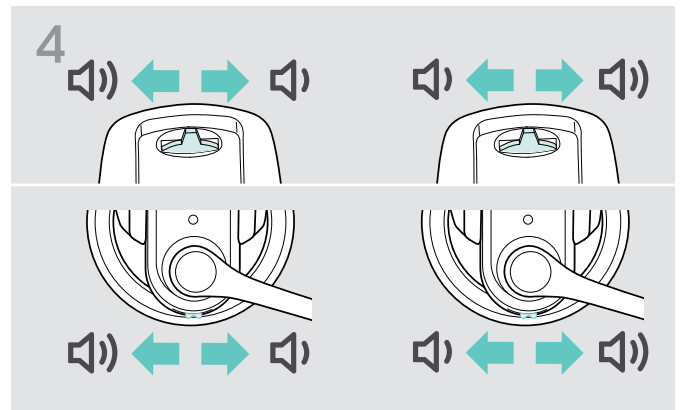

The direction of the volume up/down function of the Audio button is changed. The headset switches to standby mode.

Muting the headset's microphone

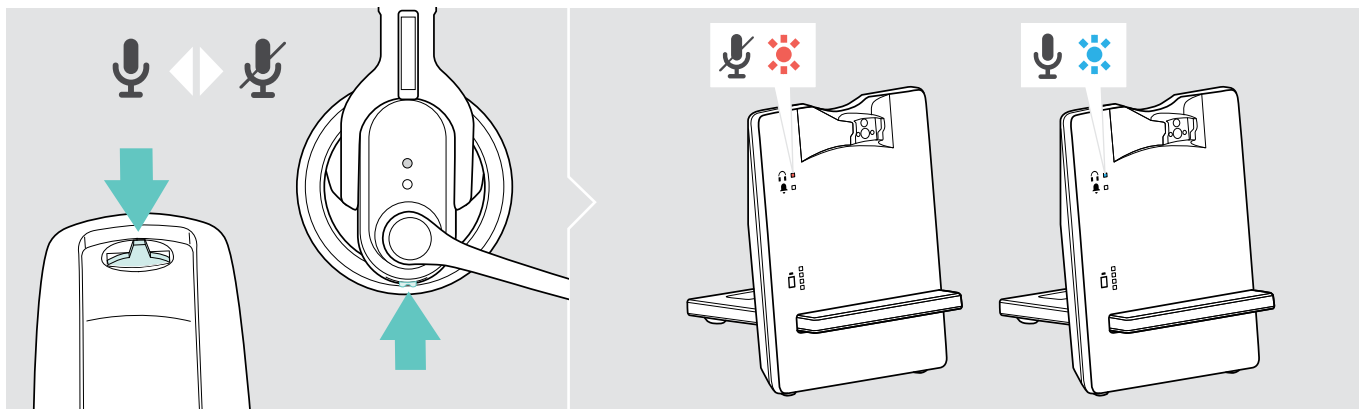

- ▶ Press the Audio button.
The microphone is muted. While the microphone is muted, the Link LED on the base station flashes red.

Unmuting the headset's microphone

- ▶ Press the Audio button.
You hear a beep in the headset. The muting is canceled and the Link LED on the base station lights up blue.

If you leave the DECT range

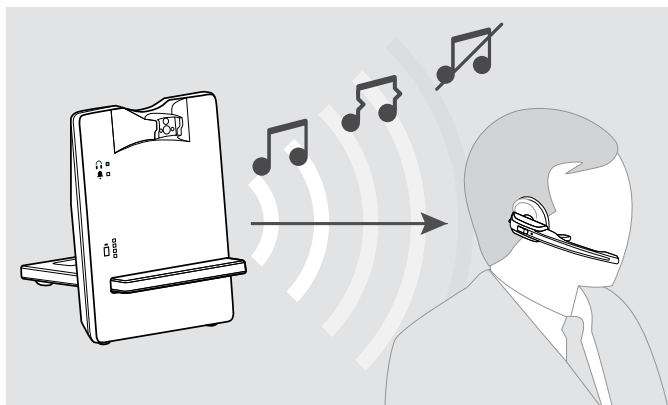

In normal office buildings, the range between headset and base station is up to 55 m.

If, during a call, the audio quality deteriorates or the link breaks down completely, you hear a descending sequence of beeps in the headset. The Link LED on the base station lights up red.

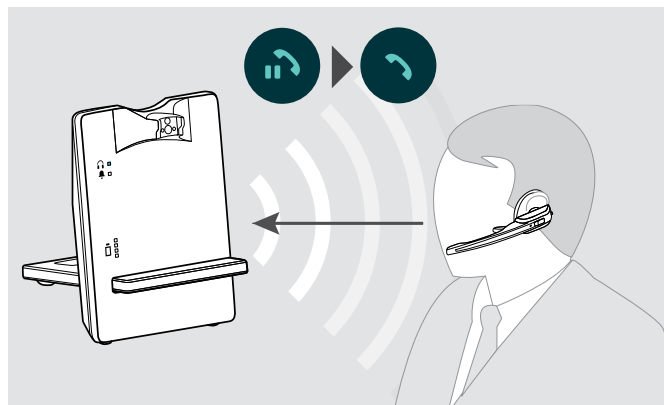

- ▶ Re-enter the DECT range of the base station within 60 seconds.
You hear a ring tone in the headset.
- ▶ Press the Link button on the headset to resume the call.
If your softphone supports call control, the call will automatically be ended 60 seconds after leaving the DECT range.

Calling via the fixed line phone using the headset

Establishing/disconnecting a wireless link

If you want to use the headset to accept, make or end calls, you have to establish a wireless link between headset and base station. You can choose between manual and automatic link establishment (see “Auto Link” on page 18):

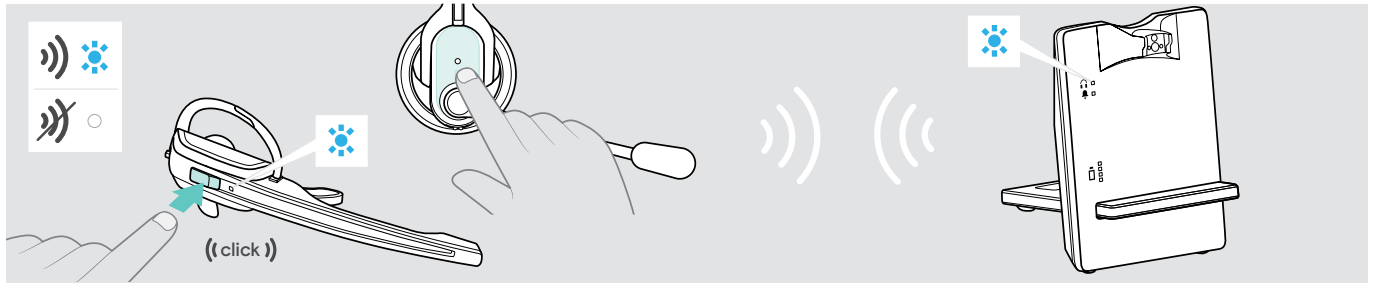

- ▷ Press the Link button on the headset.
 - The link is established. The Link LED on the base station lights up blue and the Headset LED flashes blue slowly. **OR**
 - The link is disconnected. The Link LED on the base station and the Headset LED go off. The headset is in standby mode.



If your telephone has a built-in electronic hook switch supporting the MSH standard, you can only disconnect the wireless link between headset and base station by placing the headset into the base station.

Managing calls without using a call control functionality

Accepting a call: You hear the ring tone of the fixed line phone.

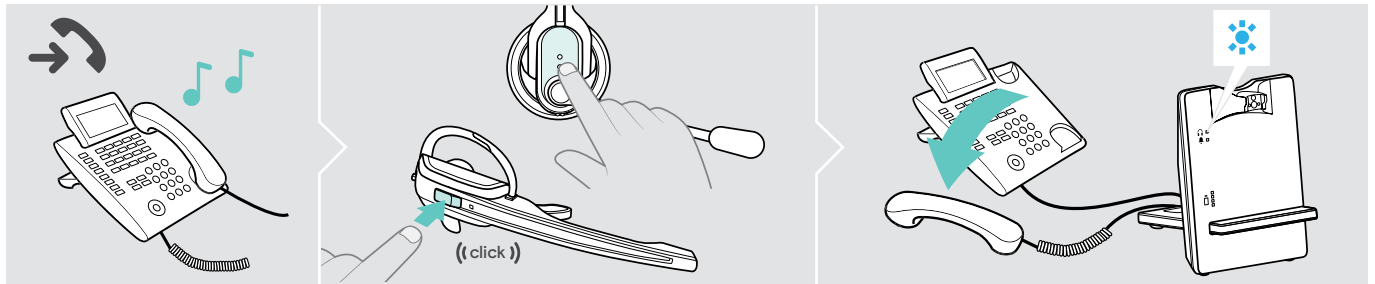

- ▷ Press the Link button on the headset.
- ▷ Lift the handset or press the “accept call” button on your fixed line phone.

Making a call:

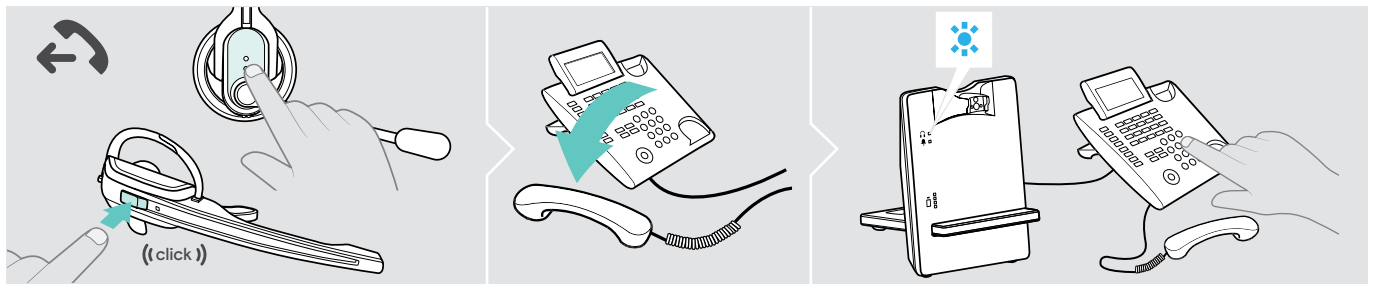

- ▷ Press the Link button on the headset to establish a link between base station and headset.
- ▷ Lift the handset and dial the desired number. The phone connection is established.

Ending a call:

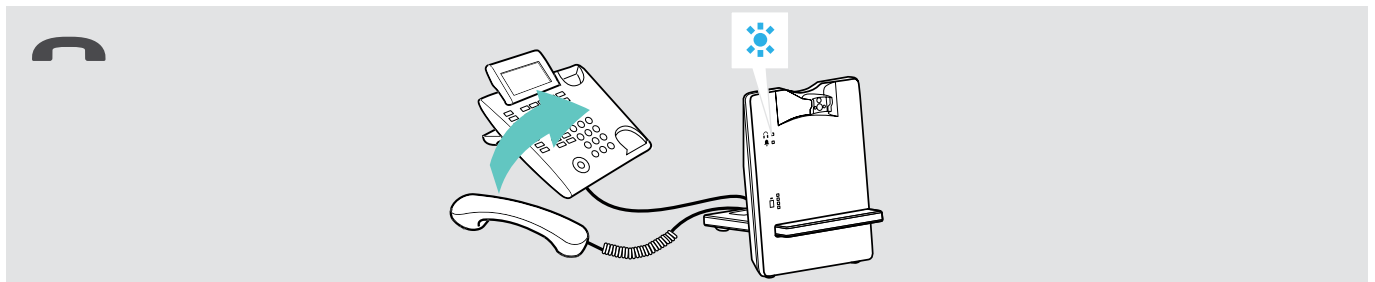

- ▷ Hang up the handset or press the “end call” button on your fixed line phone.

Managing calls using a call control functionality (EHS, HSL 10 II)

Accepting a call: You hear a ring tone in the headset.

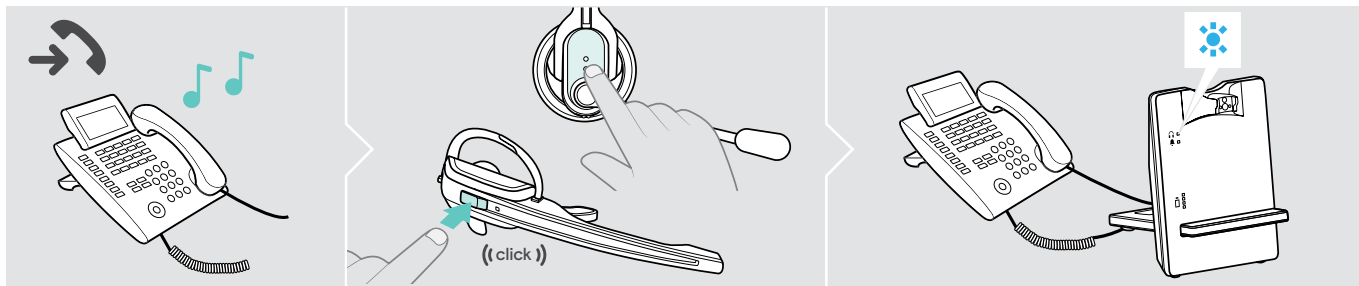

- ▶ Press the Link button on the headset to accept the call.
The handset lifter/electronic hook switch lifts the handset.

Making a call:

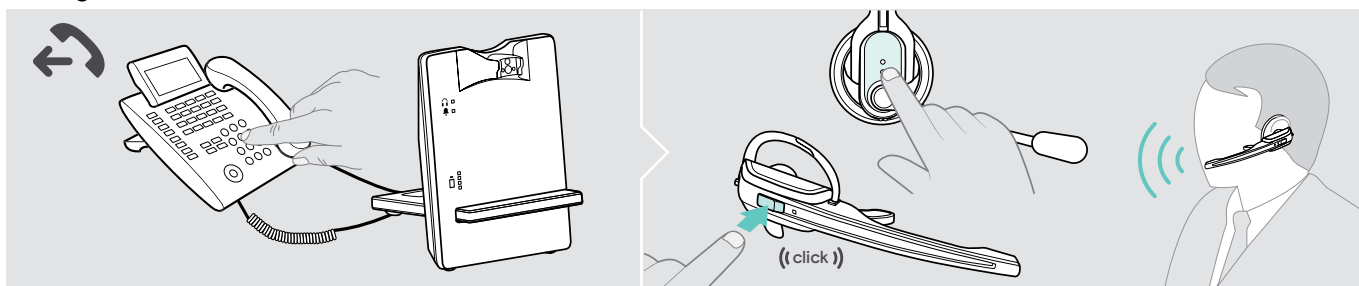

- ▶ Dial the desired number.
- ▶ Press the Link button on the headset to establish a link between base station and headset.
The phone connection is established automatically.

Ending a call:

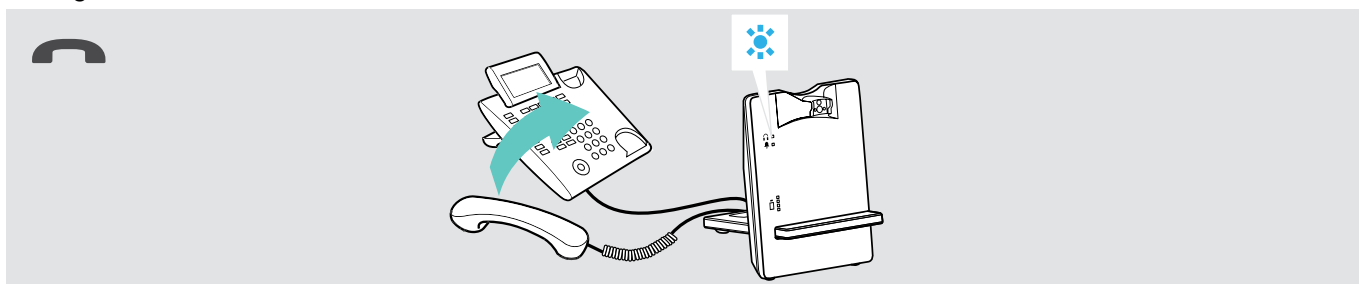

- ▶ Press the Link button. If the other party hangs up, your telephone and your headset become automatically ready to receive the next call.

Frequent callers who use an electronic hook switch with DHSG capability are recommended to activate the “Fast Link” function for faster link establishment (see page 16).

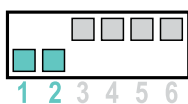

Fast Link for DHSG standard and HSL 10 II handset lifter

Recommended for frequent callers.

Shorter battery life.

Fast link establishment without delay due to hidden link to the base station.

Switching a call between headset and fixed line phone

- ▶ Press the Link button on the headset to switch between headset and handset of the fixed line phone during an ongoing call.



In case of a fixed line phone with a handset lifter/an electronic hook switch, this switching can only be done on the fixed line phone.

Calling via the computer using the headset

Establishing/disconnecting a wireless link

If you want to use the headset to accept, make or end calls, you have to establish a wireless link between headset and base station. You can choose between manual and automatic link establishment (see “Auto Link” on page 18):

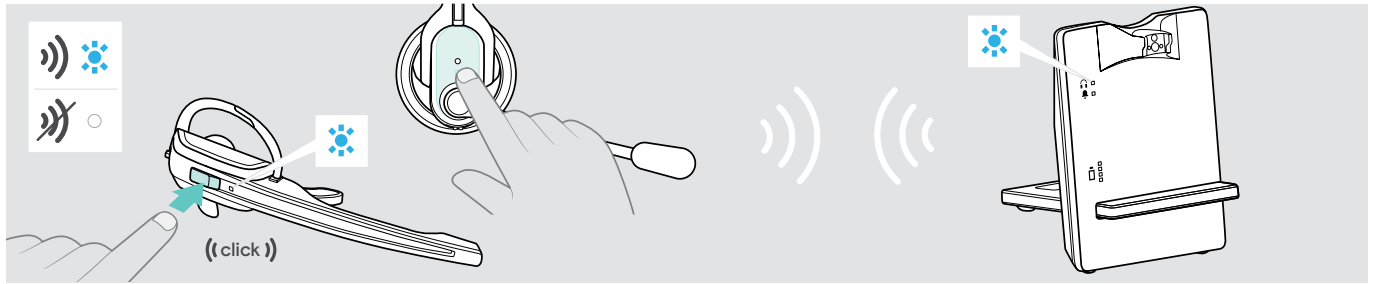

- ▷ Press the Link button on the headset.
 - The link is established. The Link LED on the base station lights up blue and the Headset LED flashes blue slowly. **OR**
 - The link is disconnected. The Link LED on the base station and the Headset LED go off. The headset is in standby mode.

Managing calls via the softphone

Accepting a call: The softphone signals that you are receiving a call. You hear a ring tone in the headset.

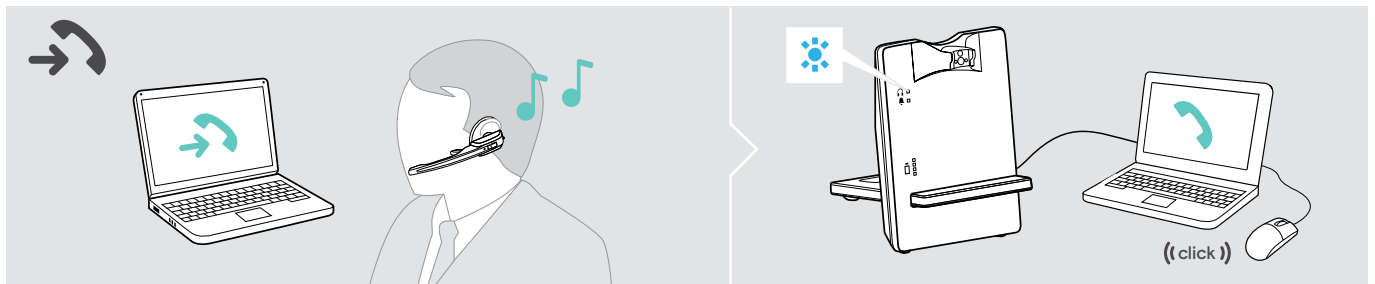

- ▷ Click on “Accept call” on your softphone.

Making a call:

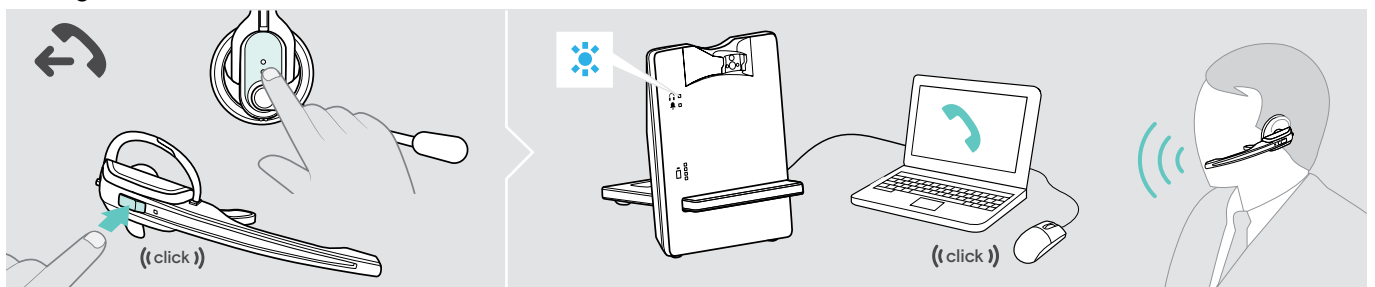

- ▷ Press the Link button on the headset to establish a link between base station and headset. If the “Auto Audio” function is activated, this step is not necessary (see page 21).
- ▷ Start the call using your softphone.

Ending a call:

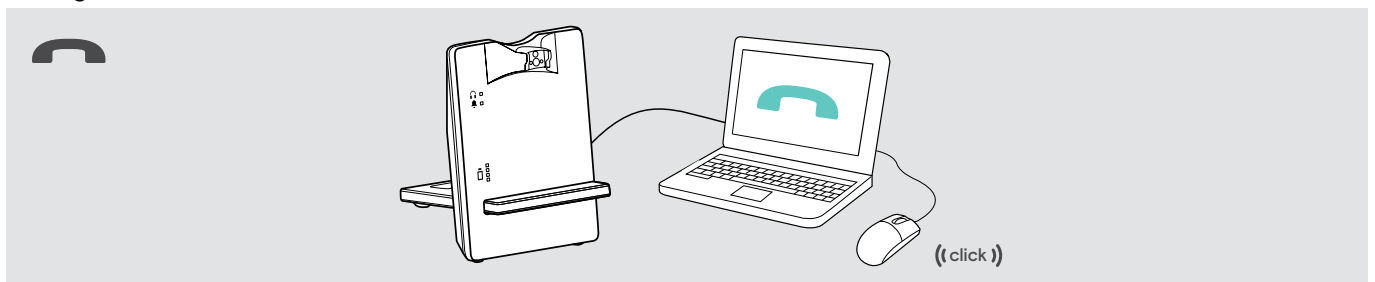

- ▷ End the call using your softphone.

Managing calls using the “EPOS Connect” call control functionality

Accepting a call: The softphone signals that you are receiving a call. You hear a ring tone in the headset.

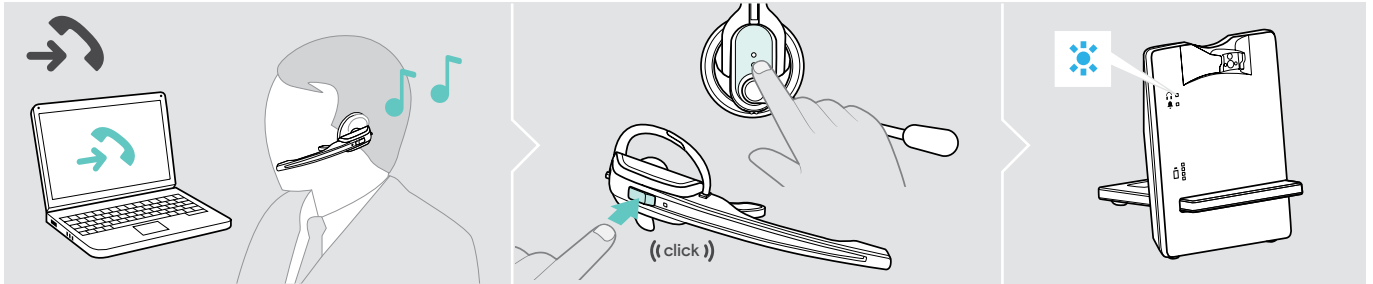

▷ Press the Link button on the headset to accept the call.

Making a call:

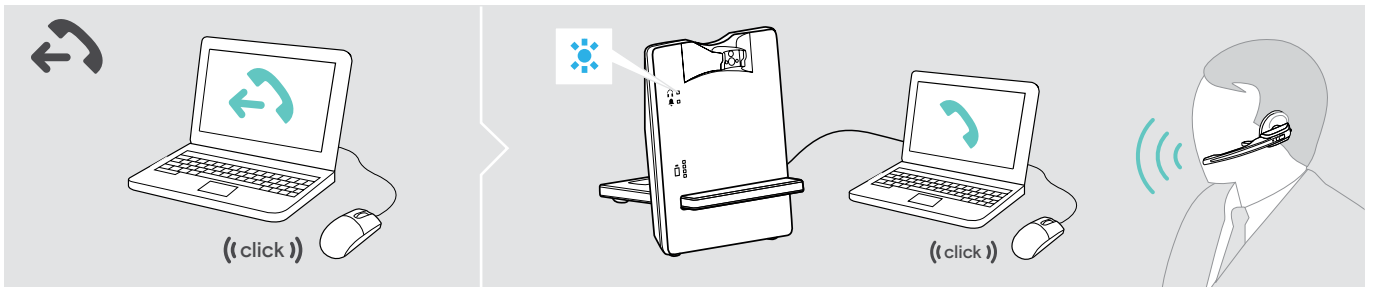

▷ Start the call using your softphone, the audio signal is automatically transmitted to the headset.

Ending a call:

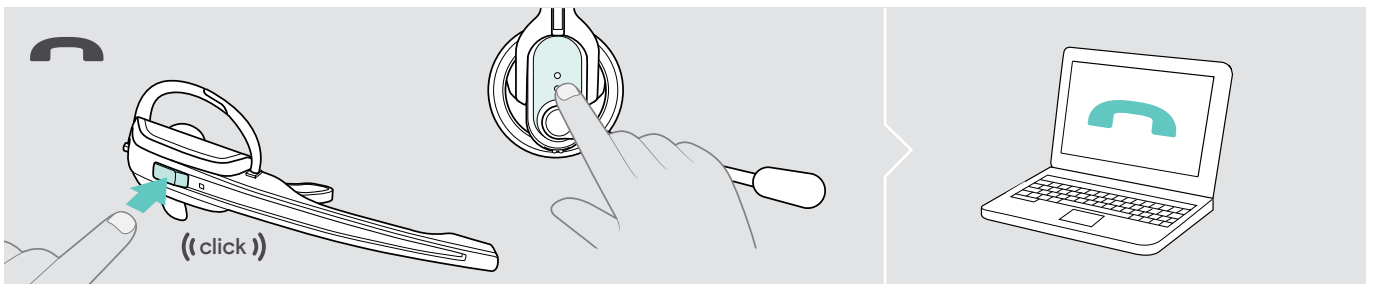

▷ Press the Link button. If the other party hangs up, your softphone and your headset become automatically ready to receive the next call.

Making a conference call

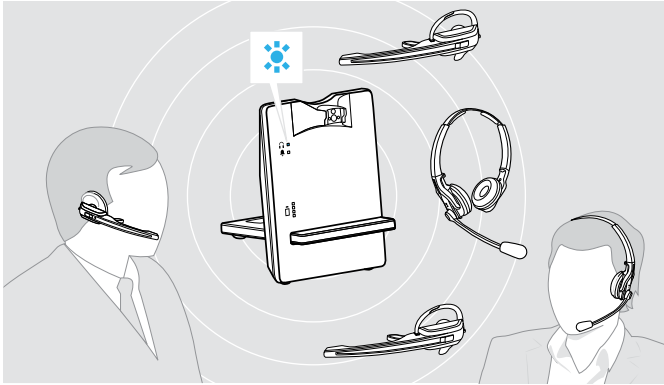

The headset system allows you to make a conference call with up to 4 headsets from the D-series.

The first headset paired (master) is used control the call establishment and end of conversation.

Pairing the MASTER headset with the base station

The Link LED on the base station is off (headset is disconnected) or lights up red (no headset paired).

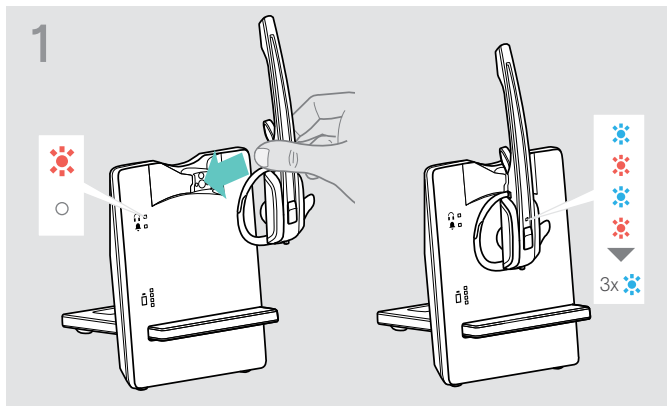

- ▷ Place the master headset into the base station. The Headset LED alternately flashes blue/red until a link to the base station is established. The Headset LED flashes blue 3 times.

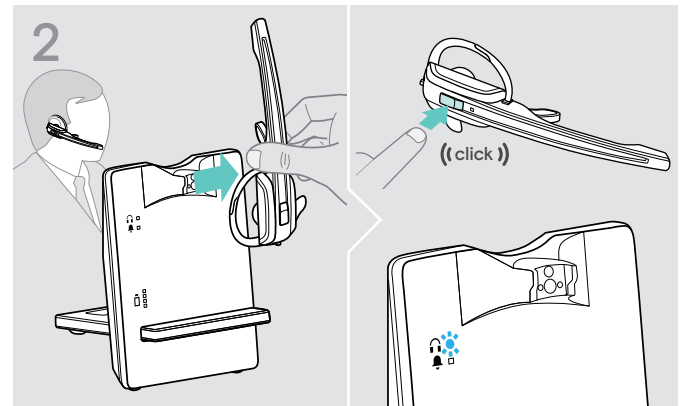

- ▷ Take the headset out of the base station and press the Link button to connect the headset with the base station. The Link LED on the base station lights up blue.

Adding a GUEST headset to a conference call

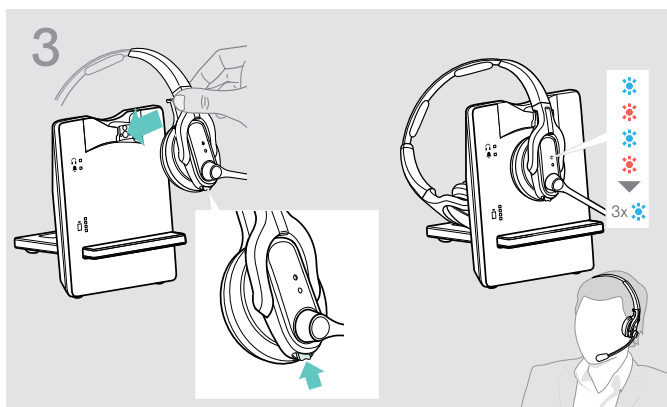

- ▷ Press and hold the Audio button while placing the guest headset into the base station of the master headset. The Headset LED alternately flashes blue/red until a link to the base station is established. The Headset LED flashes blue 3 times.

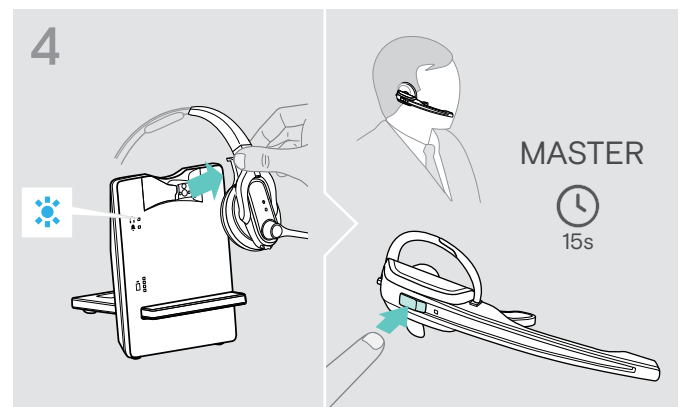

- ▷ Take the guest headset out of the base station. You hear a beep in the master headset.
- ▷ Press the Link button on the master headset within 15 seconds, to add the guest headset to the conference call.
- ▷ Repeat this procedure to add additional guest headsets to the conference call.

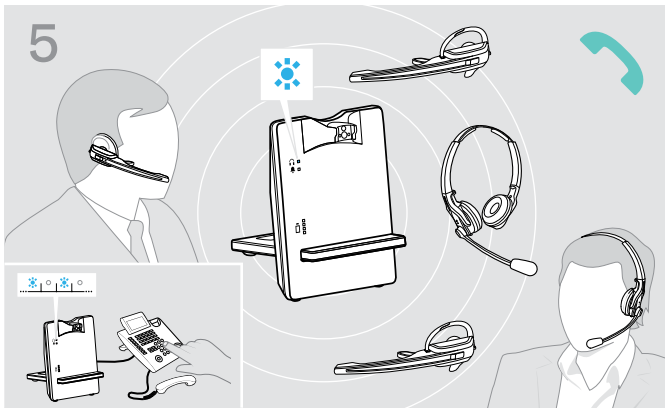

Making a call

- ▷ Call the other party.
The Link LED on the base station flashes blue.

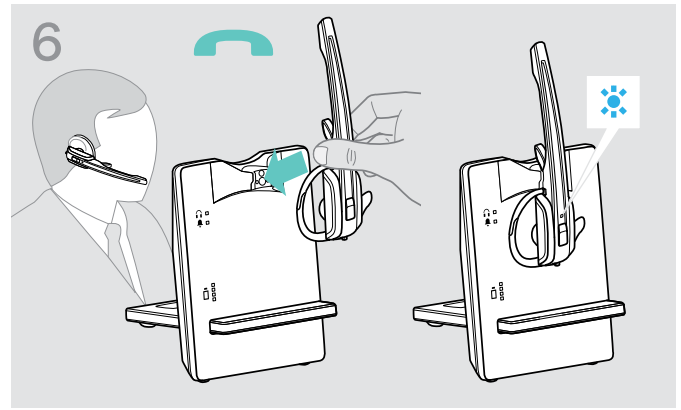

Dropping a GUEST headset from the conference call

- ▷ Press the Link button on the guest headset. The guest headset is dropped from the conference call.

Ending a conference call

- ▷ Place the master headset into the magnetic holder of the base station to end the conference call and to drop the guest headsets from the conference call.



Easy pairing

To subsequently use the guest headset with other base stations, place the guest headsets into the other base stations. The Headset LED alternately flashes blue/red until a link is established.

Charging the headset and storing the headset system

Charging the headset

Always store the headset in the base station to ensure that it is fully charged when needed. The intelligent battery charging technology prevents over-charging.

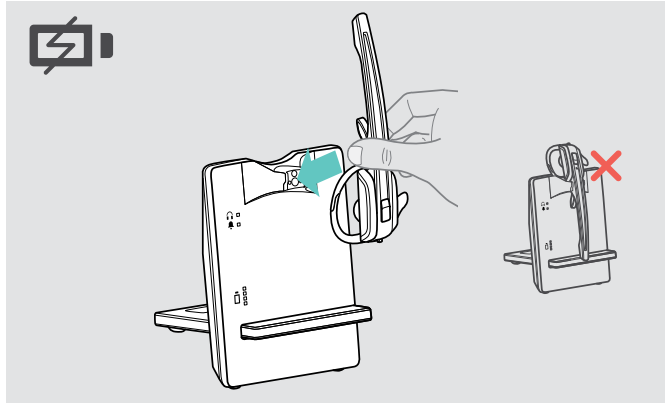

▶ Place the headset into the magnetic holder of the base station.

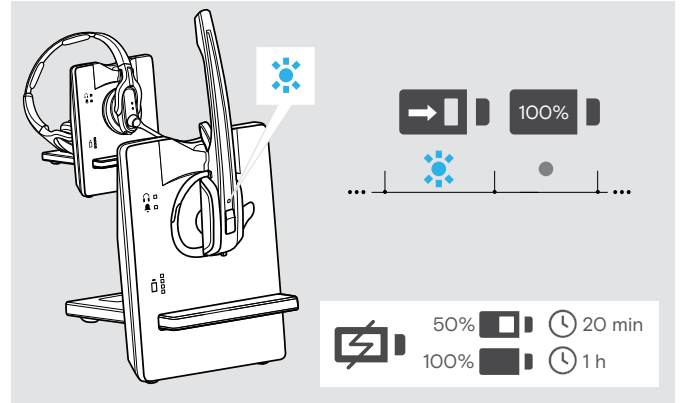

The Headset LED lights up blue and the rechargeable battery is being charged. The Charge status LED on the base station indicates the charge status.

LED segment	Required charging time	Corresponds to a talk time of	
		Wideband	Narrowband
	approx. 10 minutes	approx. 2 hour	approx. 3 hours
	approx. 20 minutes	approx. 4 hours	approx. 6 hours
	approx. 40 minutes	approx. 6 hours	approx. 9 hours
	approx. 60 minutes	approx. 8 hours	approx. 12 hours

Shortly before the rechargeable battery is about to run flat, only one LED segment lights up weakly. The Headset LED flashes red and you hear three beeps. You have several minutes of battery reserve. When the rechargeable battery is flat, the headset switches off.

i If the headset is outside the range of the base station, it will switch off after 30 minutes in order to conserve battery power.

Charging the headset using the optional CH 10 headset charger

The CH 10 headset charger is an optional accessory available from your EPOS partner. The CH 10 allows you to charge additional D series headsets, e.g. for sharing the same base station when working shifts. Several CH 10 in connection with the MCH 7 allow to charge up to 7 headsets simultaneously.

▷ Refer to the Quick Guide of the CH 10 or MCH 7 for more information.

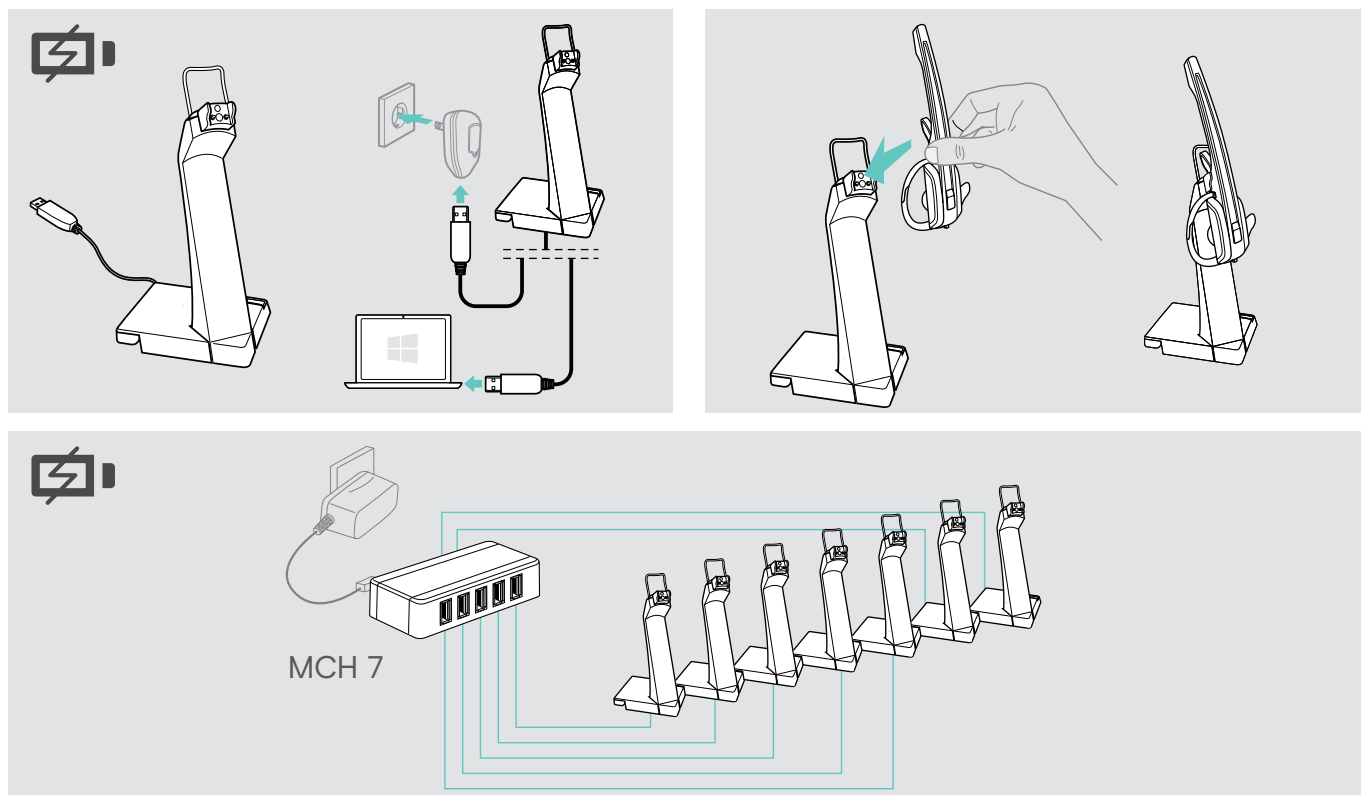

Switching the headset system off during extended non-use

You can switch off the headset system or the headset when not using the products for extended periods of time (e.g. when you are on holiday).

Switching the headset system off

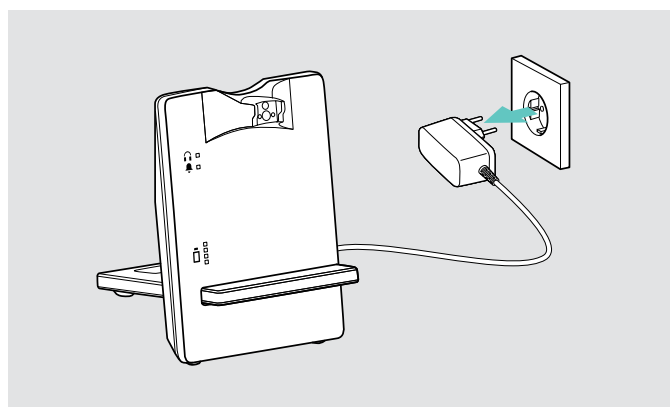

- ▷ Disconnect the base station from the mains power supply. The base station switches off immediately, the headset switches off about 30 minutes later.

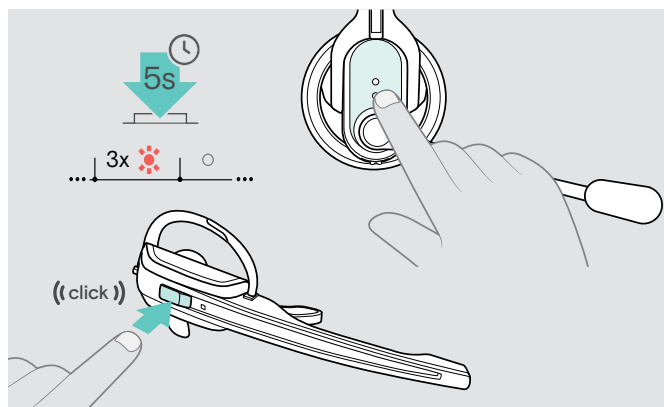

- ▷ Press and hold the Link button for 5 seconds to switch off the headset immediately. The Headset LED flashes 3 times red, the headset is switched off completely. The Link LED on the base station lights up red after a short time, the Charge status LED on the base station goes off.

Switching the headset system on and pairing the components

- ▷ Plug the power supply unit into a wall socket. The base station is switched on.
- ▷ Place the headset into the magnetic holder of the base station. The Headset LED flashes 3 times blue and then lights up blue. The base station and the headset are paired.

Sharing a workplace

The headsets and base stations of the IMPACT D series are compatible with each other. If, for example, you share a workplace, you can use one base station with different headsets. The last headset paired with the base station can still be used directly.

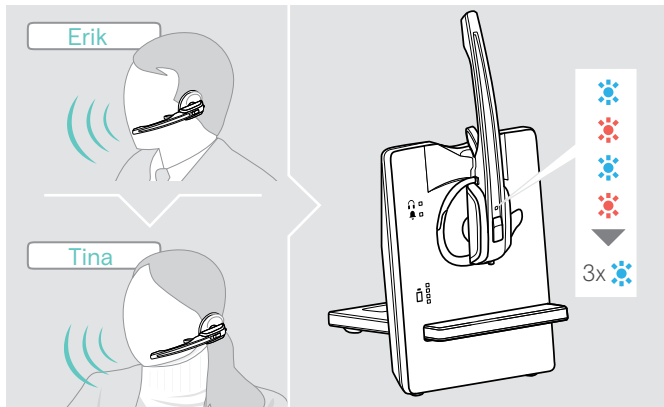

- ▷ Place the headset to be used into the magnetic holder of the base station.
The Headset LED alternately flashes blue/red until the headset is successfully paired with the base station. The Headset LED flashes 3 times blue and then goes off. You can now use the newly paired headset.
- If pairing has failed, the Link LED on the base station lights up red or is off. Repeat the procedure.

Using the headset with a third party base station (DECT-GAP telephone)

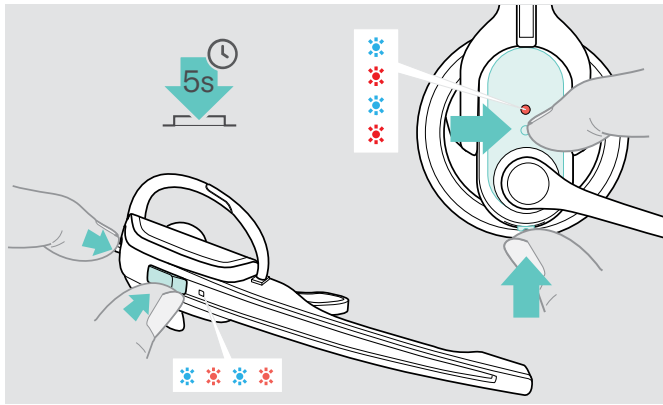

- ▷ Place the headset at a maximum distance of 1 m from the third party base station.
- ▷ Simultaneously press and hold the headset's Link button and Audio button for 5 seconds.
The headset switches to a special pairing mode and the Headset LED alternately flashes blue/red.
- ▷ Set the third party base station to a special pairing mode (see the instruction manual of the third party base station). The default code for the headset is "0000".
The headset pairs with the third party base station. If pairing is successful, the Headset LED goes off.

If pairing is not successful within 60 seconds, the headset switches back to standby mode.

Pairing the headset again with a D series base station

- ▷ Simultaneously press and hold the headset's Link button and Audio button for 5 seconds.
The headset switches to a special pairing mode and the Headset LED alternately flashes blue/red.
- ▷ Place the headset into the magnetic holder of the base station. The Headset LED flashes 3 times blue and then lights up blue. The base station and the headset are paired.

Cleaning and maintaining the headset system

CAUTION

Liquids can damage the electronics of the product!

Liquids entering the housing of the device can cause a short circuit and damage the electronics.

- ▷ Keep all liquids far away from the product.
- ▷ Do not use any cleansing agents or solvents.

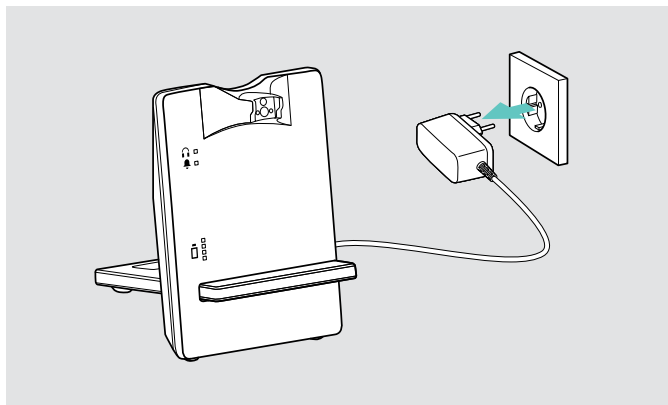

- ▷ Before cleaning, disconnect the base station from the mains power supply.

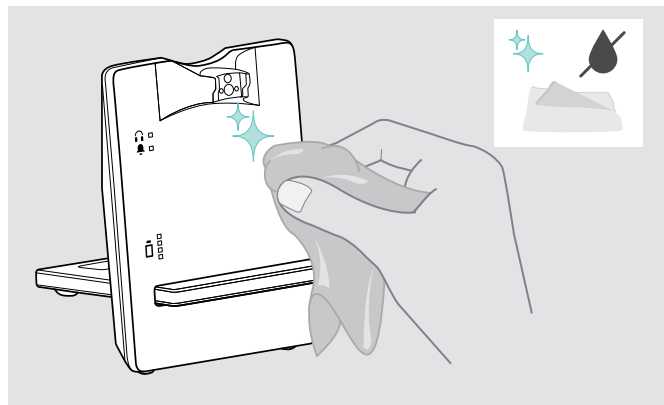

- ▷ Only use a dry and soft cloth to clean the product.

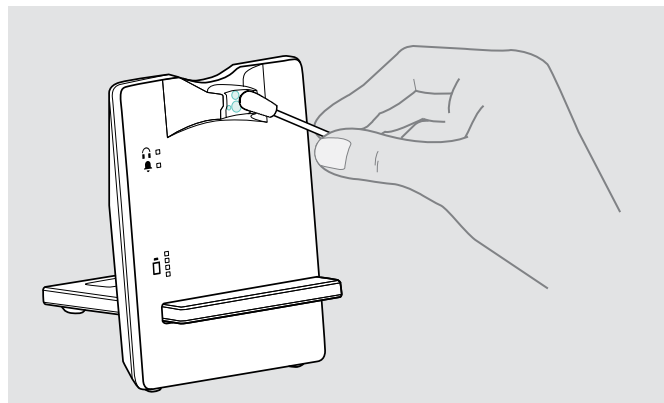
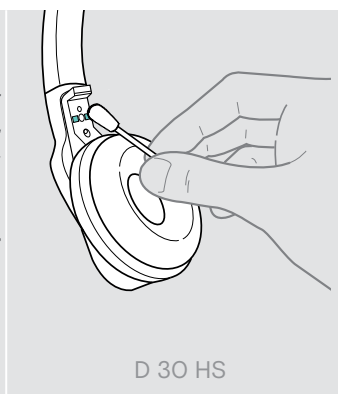

- ▷ Clean the charging contacts of the base station and the charging contacts of the headset from time to time using e.g. a cotton swab.

Replacing the ear pads

For reasons of hygiene, you should replace the ear pads from time to time. Spare ear pads are available from your EPOS partner.

Headset D 10 HS II

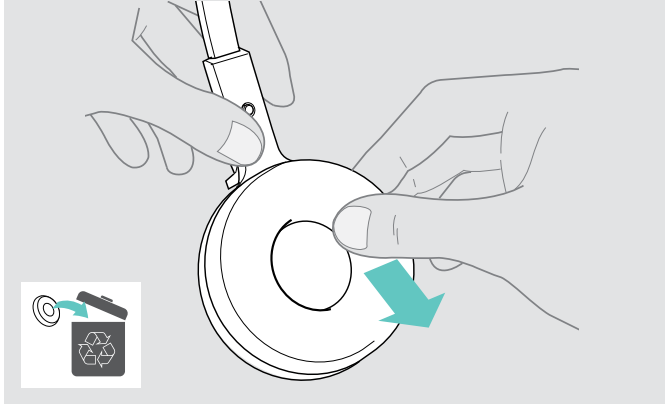

- ▷ Carefully remove the old ear pad from the ear cup.
- ▷ Make sure that the fastening ring of the old ear pad is also removed from the ear cup.

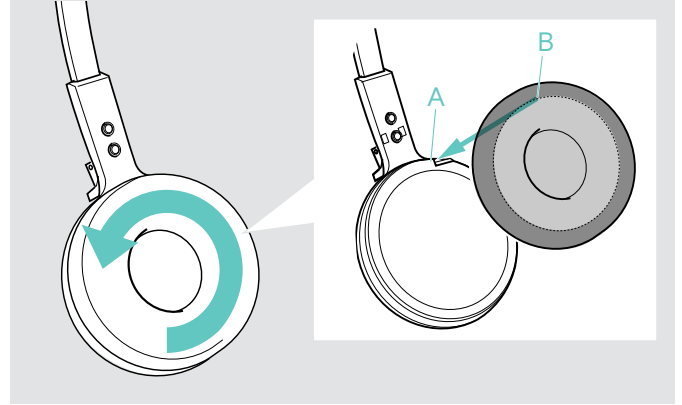

- ▷ Pull the collar **B** of the ear pad over the notch **A** of the headband.
- ▷ Turn the ear pad counter-clockwise over the notch until the collar completely surrounds the ear cup.

Headset D 30 HS

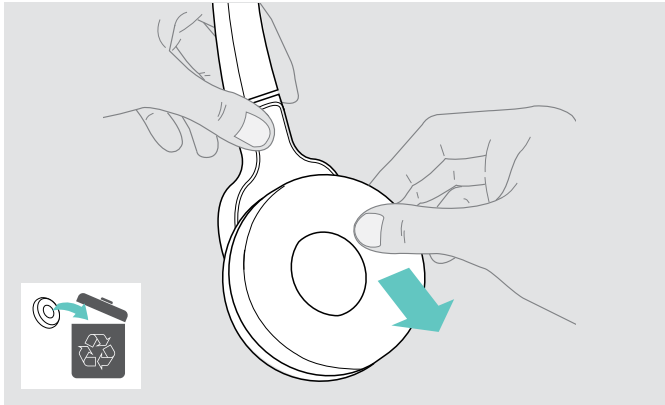

- ▷ Carefully remove the old ear pads from the ear cups.

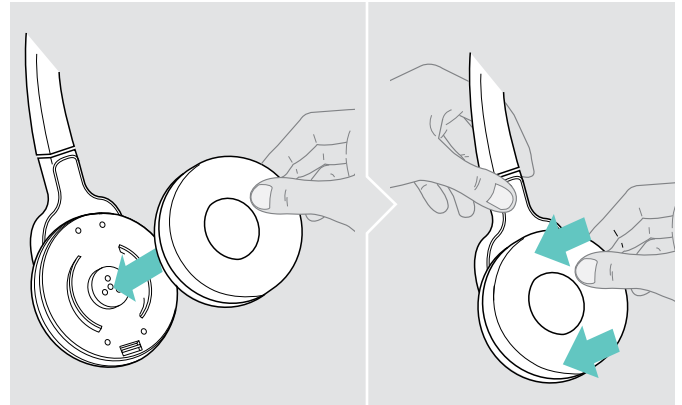

- ▷ Attach the new ear pads to the ear cups by pressing firmly around the ear pad.

Replacing the headset's rechargeable battery



CAUTION

Danger of damage to the product!

In extreme cases, abuse or misuse of rechargeable batteries or non-original EPOS batteries can lead to explosion, fire development, heat generation or smoke/gas development.

- ▷ Only use original EPOS spare rechargeable batteries. Spare rechargeable batteries are available from your EPOS partner.

CAUTION

Damage to the product due to improper handling

The cables can be kinked or damaged if you open the battery compartment too jerkily.

- ▷ Carefully open the battery compartment and loosen the connector plug of the rechargeable battery.

Headset D 10 HS II

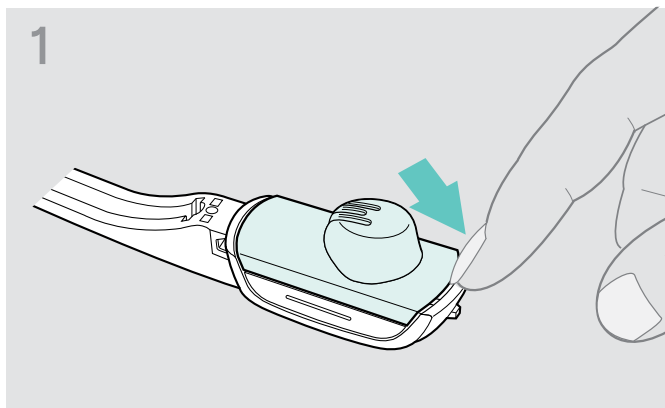

- ▷ Remove the earhook or the headband (see page 13) and open the battery compartment.

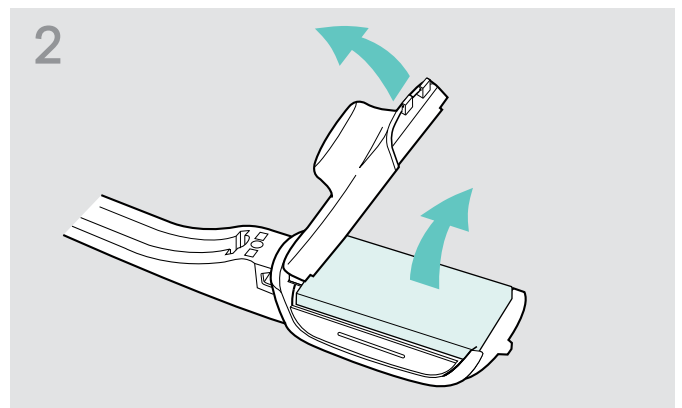

- ▷ Carefully move the battery compartment cover in the direction of the arrow until you overcome a slight resistance.
- ▷ Remove the rechargeable battery and carefully loosen the connector plug of the rechargeable battery.

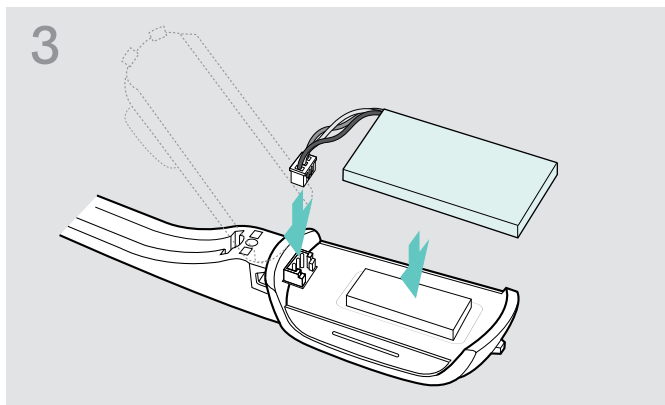

- ▷ Insert the connector plug of the new rechargeable battery into the connection socket. Observe correct orientation of the connector plug.

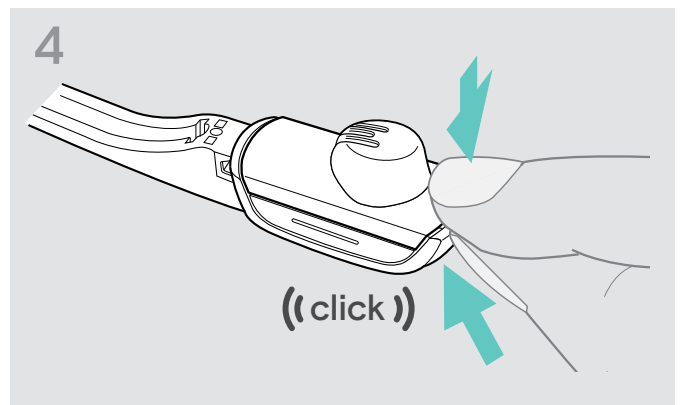

- ▷ Close the battery compartment.

Headset D 30 HS

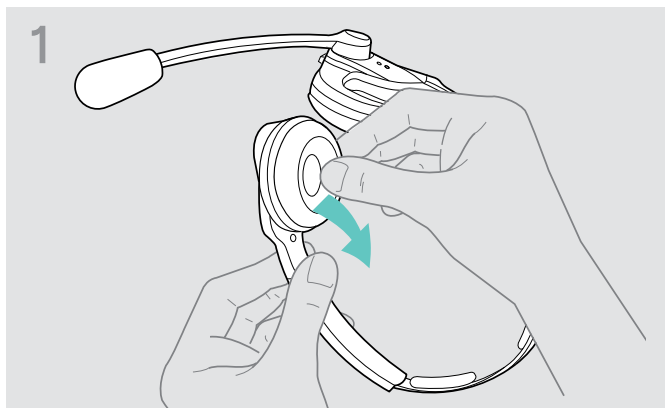

▷ Carefully remove the ear pad from the ear cup where the battery compartment is located.

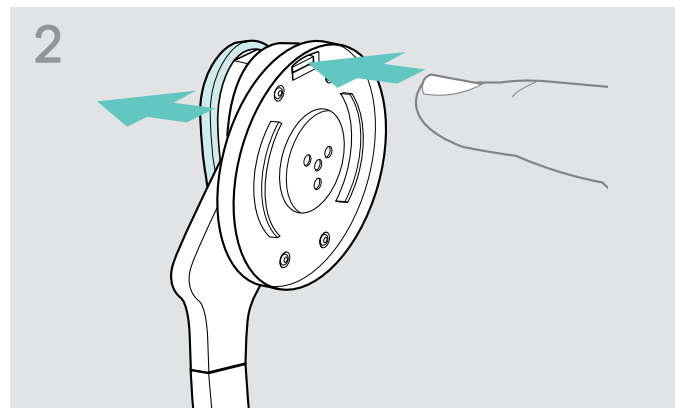

▷ Open the battery compartment.



▷ Remove the rechargeable battery and carefully loosen the connector plug of the rechargeable battery.

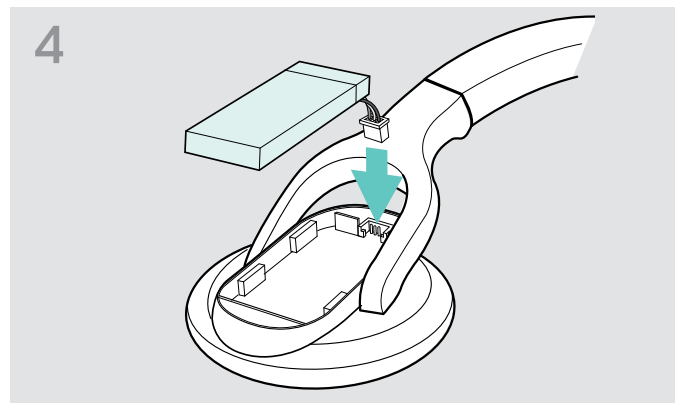

▷ Insert the connector plug of the new rechargeable battery into the connection socket. Observe correct orientation of the connector plug.



▷ Replace the battery compartment cover.

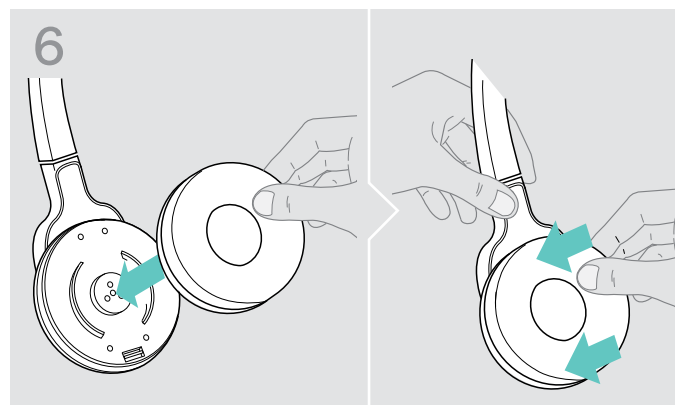

▷ Reattach the ear pad to the ear cup by pressing firmly around the ear pad.

If a problem occurs ...

Problem	Possible cause	Solution	Page
Headset is placed into the base station but the Charge status LED is off	Base station is not connected to the mains power supply	▷ Connect the base station to the mains power supply.	9
	Rechargeable battery is deep discharged	▷ Wait several minutes until the Charge status LED lights up.	31
		For quick-charging the headset: ▷ Briefly press the Set button at the rear of the base station.	–
Link between headset and base station cannot be established	Headset is not paired with the base station, the Link LED lights up red	▷ Place the headset into the base station.	31
	Base station is only connected via the USB cable	▷ Connect the base station to the mains power supply.	9
Bad radio link between headset and base station	Transmission range is exceeded	▷ Reduce the distance between headset and base station.	–
		▷ Adjust the radio range.	17
Noise interference and connection loss	Microphone rubs on the cheek or perhaps the beard	▷ Bend the microphone boom so that the microphone is about 0.8 - 1.2" (2 - 3 cm) from the corner of your mouth.	13
	Too many DECT systems within the radio range	▷ Reduce the radio range.	17
		▷ Set the base station to narrowband transmission.	18
	Distance between base station and fixed line phone is so small that interference occurs	▷ Increase the distance between base station and fixed line phone.	–
Rechargeable battery cannot be charged	Charging contacts of the headset or the base station are dirty	▷ Clean the charging contacts on the headset and on the base station.	34
	Rechargeable battery is defective/worn out	▷ Replace the defective rechargeable battery with a new one.	36
	Headset is not properly placed in the base station	▷ Check if the headset is properly placed into the magnetic holder.	31
Sound from the fixed line phone is distorted and disturbed	Base station is not adjusted to the fixed line phone	▷ Use the ABC switch to adjust the base station to your fixed line phone.	20
No acoustic signal to be heard in the headset	The volume is reduced when the headset is in idle mode.	▷ Increase the volume while you are not on a call.	20
The talk time is reduced	Overaged rechargeable battery	▷ Replace the overaged rechargeable battery with a new one.	36
	Large distance between base station and headset	▷ Reduce the distance if possible. Larger distances require a higher transmission power and reduce the talk time.	–
	Many DECT systems in the same area	▷ Switch off DECT systems that are currently not required. Congestion requires a higher transmission power and reduces the talk time. How many DECT systems can be used in the same room? This depends on various conditions: • up to 40 IMPACT D systems in narrowband mode (Americas) • up to 80 IMPACT D systems in narrowband mode (Rest of World)	–
	Narrowband/wideband setting	▷ Set the base station to narrowband transmission as it requires less power than wideband transmission.	18

Problem	Possible cause	Solution	Page
Bad audio quality, the other party sounds too low or too loud	Microphone sensitivity is not correctly adjusted	▷ Adjust the microphone sensitivity.	20
	Microphone is too far away from your mouth	▷ Adjust the microphone position.	13
Bad audio quality, you sound distorted/echoing to the other party, who also hears background noise	Microphone sensitivity is not correctly adjusted	▷ Adjust the microphone sensitivity.	20

If a problem occurs that is not listed in the above table or if the problem cannot be solved with the proposed solutions, please contact your local EPOS partner for assistance.

To find an EPOS partner in your country, search at www.eposaudio.com.

Restoring factory default settings (Reset)

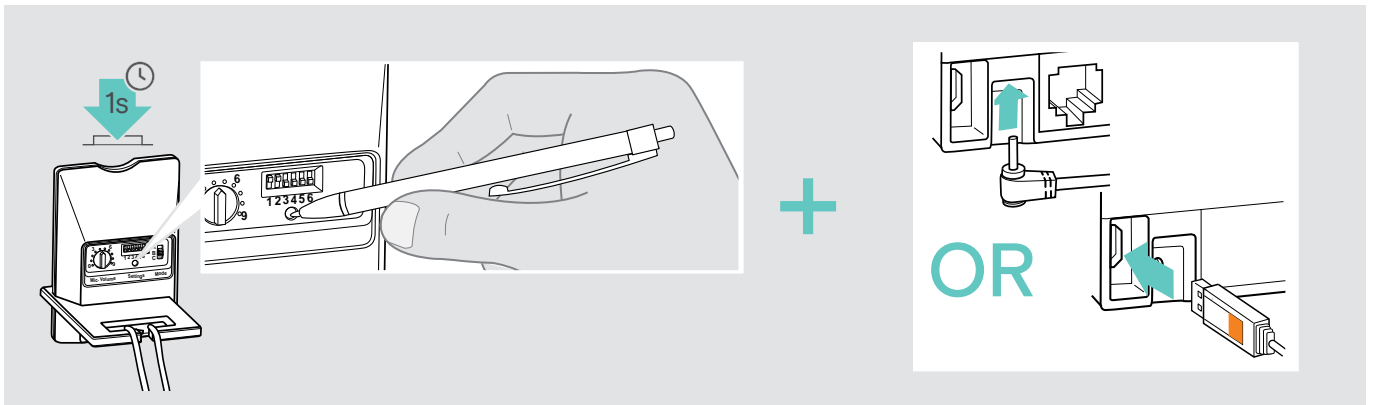

- ▷ Disconnect the base station from the USB cable and the mains.
- ▷ Use a pointed object to press the Set button for approx. 1 second while reconnecting either the mains or the USB connection to the base station.
The factory default settings are restored.

Specifications

Headset D 10 HS II | D 30 HS

Dimensions (W x H x D)	D 10 HS II: 140 x 24 x 22 mm / 5.51 x 0.95 x 0.87 in D 30 HS: 170 x 175 x 55 mm / 6.69 x 6.89 x 2.47 in
Weight	D 10 HS II weight with: ear hook: 22 g / 0.78 oz / 0.049 lbs headband: 50 g / 1.76 oz / 0.11 lbs D 30 HS: 85 g / 3.00 oz / 0.19 lbs
Talk time	narrowband: up to 12 hours wideband: up to 8 hours
Charging time	50%: approx. 20 min 100%: approx. 1 hour
Range (environment dependent)	free line of sight: up to 180 m in office buildings: up to 55 m
Rechargeable battery (built-in)	Lithium Polymer; 3.7 V; 215 mAh
Output power	EU/AUS: 24 dbm/250 mW USA/CAN: 20.4 dbm/100 mW
Speaker type	dynamic, neodymium magnet
Microphone type	electret microphone, noise canceling
Operating temperature range	+5 °C to +45 °C / +41 °F to +113 °F
Storage temperature range	-20 °C to +70 °C / -4 °F to +158 °F

Base station

Dimensions (W x H x D)	88 x 119 x 100 mm / 3.46 x 4.69 x 3.94 in
Weight	D BS Phone: approx. 355 g / 12.52 oz / 0.78 lbs D BS USB ML: approx. 350 g / 12.35 oz / 0.77 lbs
Operating temperature range	+5 °C to +45 °C / +41 °F to +113 °F
Storage temperature range	-20 °C to +70 °C / -4 °F to +158 °F

Power supply unit

Nominal input voltage	100 – 240 V~
Nominal input current	max. 0.2 A
Mains frequency	50 – 60 Hz
Nominal output voltage	5.9 V =
Nominal output current	max. 850 mA
Operating temperature range	+5 °C to +45 °C / +41 °F to +113 °F
Storage temperature range	-20 °C to +70 °C / -4 °F to +158 °F
Relative humidity	operation: 20 to 85% storage: 20 to 95%
Weight	approx. 75 g / 2.65 oz / 0.17 lbs

DECT

	EU, UK, AU: CAT IQ 1.0	US version: DECT 6.0
Frequency	1,880 to 1,900 MHz	1,920 to 1,930 MHz
SAR value of D 10 HS II	Ear hook: 0.029W/kg Headband: 0.050 W/kg	0.048W/kg
SAR value of D 30 HS	0.058 W/kg (max. 10 g SAR)	0.025 W/kg (max. 1 g SAR)

In compliance with

EMC	EN 301489-6
Radio	EN 301406
Safety	EN 60950-1
SAR	EN 50360 ref EN 62209-1 (headset)

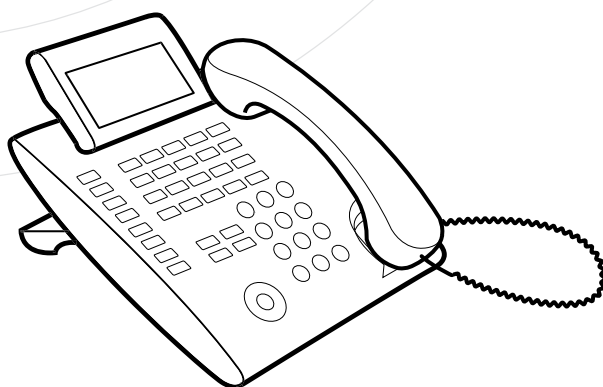
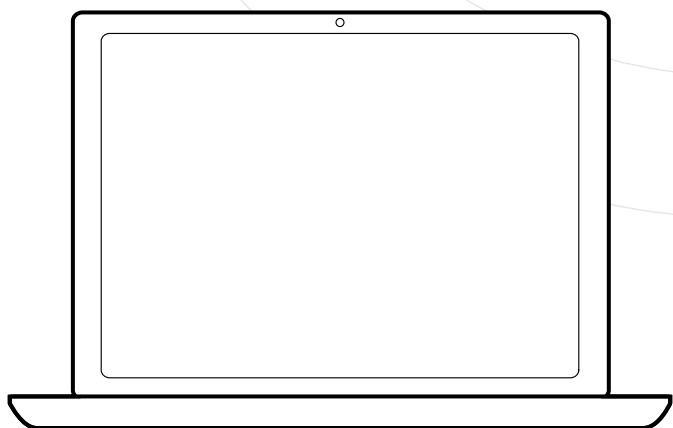
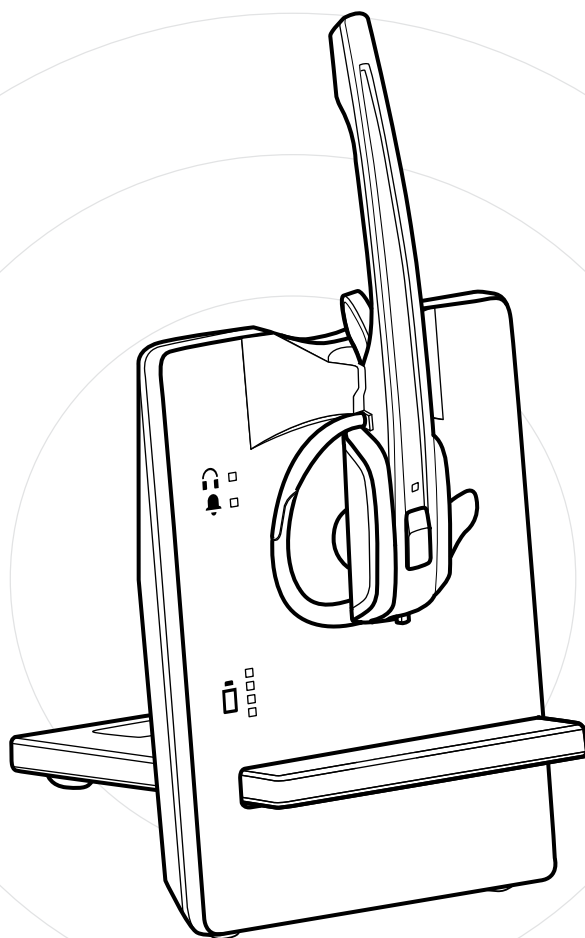

DSEA A/S

Kongebakken 9, DK-2765 Smørum, Denmark

www.eposaudio.com