

# Grandstream Networks, Inc.

---

GRP2612/GRP2612P/GRP2612W | GRP2613

GRP2614 | GRP2615 | GRP2616

Carrier-Grade IP Phones

## Administration Guide



GRP2612 / GRP2612P / GRP2612W



GRP2613



GRP2614



GRP2615



GRP2616



## **COPYRIGHT**

©2019 Grandstream Networks, Inc. <http://www.grandstream.com>

All rights reserved. Information in this document is subject to change without notice. Reproduction or transmittal of the entire or any part, in any form or by any means, electronic or print, for any purpose without the express written permission of Grandstream Networks, Inc. is not permitted.

The latest electronic version of this guide is available for download here:

<http://www.grandstream.com/support>

Grandstream is a registered trademark and Grandstream logo is trademark of Grandstream Networks, Inc. in the United States, Europe and other countries.

## **CAUTION**

Changes or modifications to this product not expressly approved by Grandstream, or operation of this product in any way other than as detailed by this guide, could void your manufacturer warranty.

## **WARNING**

Please do not use a different power adaptor with devices as it may cause damage to the products and void the manufacturer warranty.



## U.S. FCC Part 68 Regulatory Information

This equipment complies with Part 68 of the FCC rules. Located on the equipment is a label that contains, among other information, the ACTA registration number and ringer equivalence number (REN). If requested, this information must be provided to the telephone company.

The REN is used to determine the quantity of devices which may be connected to the telephone line. Excessive REN's on the telephone line may result in the devices not ringing in response to an incoming call. In most, but not all areas, the sum of the REN's should not exceed five (5.0). To be certain of the number of devices that may be connected to the line, as determined by the total REN's contact the telephone company to determine the maximum REN for the calling area.

This equipment cannot be used on the telephone company-provided coin service. Connection to Party Line Service is subject to State Tariffs.

If this equipment causes harm to the telephone network, the telephone company will notify you in advance that temporary discontinuance of service may be required. If advance notice isn't practical, the telephone company will notify the customer as soon as possible. Also, you will be advised of your right to file a complaint with the FCC if you believe it is necessary.

The telephone company may make changes in its facilities, equipment, operations, or procedures that could affect the operation of the equipment. If this happens, the telephone company will provide advance notice in order for you to make the necessary modifications in order to maintain uninterrupted service.

If trouble is experienced with this equipment, please contact (Agent in the US):

**Company Name:** Grandstream Networks, Inc.

**Address:** 126 Brookline Ave, 3rd Floor Boston, MA 02215, USA

**Tel:** 1-617-5669300

**Fax:** 1-617-2491987

If the trouble is causing harm to the telephone network, the telephone company may request you to remove the equipment from the network until the problem is resolved.

This equipment uses the following USOC jacks: RJ45C.

It is recommended that the customer install an AC surge arrester in the AC outlet to which this device is connected. This is to avoid damaging the equipment caused by local lightning strikes and other electrical surges.

Since this device has the HAC function, the earpiece is easy to absorb small, please take care to avoid scratching.



## U.S. FCC Part 15 Regulatory Information

This device complies with part 15 of the FCC Rules. Operation is subject to the following two conditions:

(1) This device may not cause harmful interference, and (2) this device must accept any interference received, including interference that may cause undesired operation.

Any Changes or modifications not expressly approved by the party responsible for compliance could void the user's authority to operate the equipment.

**Note:** This equipment has been tested and found to comply with the limits for a Class B digital device, pursuant to part 15 of the FCC Rules. These limits are designed to provide reasonable protection against harmful interference in a residential installation. This equipment generates, uses and can radiate radio frequency energy and, if not installed and used in accordance with the instructions, may cause harmful interference to radio communications. However, there is no guarantee that interference will not occur in a particular installation. If this equipment does cause harmful interference to radio or television reception, which can be determined by turning the equipment off and on, the user is encouraged to try to correct the interference by one or more of the following measures:

- Reorient or relocate the receiving antenna.
- Increase the separation between the equipment and receiver.
- Connect the equipment into an outlet on a circuit different from that to which the receiver is connected.
- Consult the dealer or an experienced radio/TV technician for help.

This equipment complies with FCC radiation exposure limits set forth for an uncontrolled environment. This equipment should be installed and operated with minimum distance 20cm between the radiator& your body. This transmitter must not be co-located or operating in conjunction with any other antenna or transmitter.



## Directive 2014/53/EU Regulatory Information

*This applies to GRP2612W/GRP2614/GRP2615/GRP2616 only*

Operating Frequency Band (RF)	Max Power	
2402-2480MHz (TX&RX)	BT-EDR	8.15dBm
2402-2480MHz (TX&RX)	BT-BLE	7.21dBm
2412-2472MHz (TX&RX)	802.11b	18.15dBm
	802.11g	18.42dBm
	802.11n-20	19.06dBm
5150-5250MHz (TX&RX)	802.11a	19.28dBm
	802.11n-20	18.78dBm
	802.11n-40	19.10dBm
	802.11ac20	18.89dBm
	802.11ac40	18.66dBm
	802.11ac80	15.80dBm
5250-5350MHz (TX&RX)	802.11a	18.63dBm
	802.11n-20	18.60dBm
	802.11n-40	18.93dBm
	802.11ac20	18.59dBm
	802.11ac40	18.38dBm
	802.11ac80	15.85dBm
5470-5725MHz (TX&RX)	802.11a	18.19dBm
	802.11n-20	18.32dBm
	802.11n-40	18.34dBm
	802.11ac20	18.44dBm
	802.11ac40	17.72dBm
	802.11ac80	15.45dBm



## Caution: Exposure to Radio Frequency Radiation

This equipment complies with EU radiation exposure limits set forth for an uncontrolled environment. This equipment should be installed and operated with minimum distance of 20 cm between the radiator and your body.

## CE Authentication



AT	BE	CY	CZ	DK	EE	FI
FR	DE	EL	HU	IE	IT	LV
LT	LU	MT	NL	PL	PT	SK
SI	ES	SE	UK	BG	RO	HR

In all EU member states, operation of 5150 - 5350 MHz is restricted to indoor use only.

Hereby, Grandstream Networks, Inc. declares that the radio equipment GRP2612W, GRP2614, GRP2615 and GRP2616 are in compliance with Directive 2014/53/EU.

The full text of the EU declaration of conformity is available at the following internet address:

<http://www.grandstream.com/support/resources/>

## GNU GPL INFORMATION

GRP26XX firmware contains third-party software licensed under the GNU General Public License (GPL). Grandstream uses software under the specific terms of the GPL. Please see the GNU General Public License (GPL) for the exact terms and conditions of the license.

Grandstream GNU GPL related source code can be downloaded from Grandstream web site from:

[http://www.grandstream.com/sites/default/files/Resources/grp\\_gpl\\_color.tar.gz](http://www.grandstream.com/sites/default/files/Resources/grp_gpl_color.tar.gz)



# Table of Contents

<b>DOCUMENT PURPOSE .....</b>	<b>12</b>
<b>CHANGE LOG .....</b>	<b>13</b>
Firmware Version 1.0.1.17 .....	13
Firmware Version 1.0.1.7.....	13
Firmware Version 1.0.0.31 .....	13
Firmware Version 1.0.0.16 .....	13
<b>GUI INTERFACE EXAMPLES.....</b>	<b>14</b>
<b>WELCOME .....</b>	<b>15</b>
<b>PRODUCT OVERVIEW .....</b>	<b>16</b>
Feature Highlights .....	16
Technical Specifications .....	17
<b>GETTING STARTED.....</b>	<b>24</b>
Equipment Packaging.....	24
GRP26XX Phone Setup .....	25
<i>Using the Phone Stand.....</i>	<i>25</i>
<i>Using the Slots for Wall Mounting.....</i>	<i>25</i>
Connecting the GRP26XX.....	26
Configuration via Keypad .....	26
Configuration via Web Browser .....	34
Saving Configuration Changes.....	35
Rebooting from Remote Locations.....	35
<b>CONFIGURATION GUIDE .....</b>	<b>36</b>
Status Page Definitions .....	36
Account Page Definitions .....	38
Settings Page Definitions .....	55
Network Page Definitions .....	86





Maintenance Page Definitions.....	93
Directory Page Definitions.....	100
<b>BLF LED PATTERNS .....</b>	<b>104</b>
<b>NAT SETTINGS .....</b>	<b>106</b>
<b>BLUETOOTH (AVAILABLE ON GRP2614/GRP2615 &amp; GRP2616 ONLY) .....</b>	<b>107</b>
<b>PACKET CAPTURE .....</b>	<b>108</b>
<b>CLICK-TO-DIAL.....</b>	<b>109</b>
<b>OUTBOUND NOTIFICATION SUPPORT .....</b>	<b>110</b>
<b>UPGRADING AND PROVISIONING .....</b>	<b>122</b>
Unified Firmware .....	122
Dual-image Firmware .....	122
Firmware Upgrade.....	123
<i>Upgrade via Keypad Menu .....</i>	<i>123</i>
<i>Upgrade via Web GUI.....</i>	<i>124</i>
<i>No Local TFTP/FTP/HTTP Servers .....</i>	<i>124</i>
Phone Provisioning.....	125
<i>Configuration File Download.....</i>	<i>125</i>
<i>No Touch Provisioning .....</i>	<i>127</i>
Shortcut of Upgrade and Provision via Keypad Menu .....	127
<b>GRP26XX TOOLS .....</b>	<b>128</b>
<b>RESTORE FACTORY DEFAULT SETTING .....</b>	<b>129</b>
Restore Factory settings using LCD Menu.....	129
<b>EXPERIENCING GRP26XX.....</b>	<b>130</b>



## Table of Tables

Table 1: GRP26XX Features in a Glance .....	16
Table 2: GRP2612/GRP2612P/GRP2612W Technical Specifications .....	17
Table 3: GRP2613 Technical Specifications .....	19
Table 4: GRP2614 Technical Specifications .....	20
Table 5: GRP2615 Technical Specifications .....	21
Table 6: GRP2616 Technical Specifications .....	22
Table 7: Equipment Packaging .....	24
Table 8: Configuration Menu .....	27
Table 9: Status Page Definitions .....	36
Table 10: Account Page Definitions .....	38
Table 11: Settings Page Definitions .....	55
Table 12: Network Page Definitions .....	86
Table 13 : Maintenance Page Definitions .....	93
Table 14: BLF LED Patterns.....	104
Table 15: Action URL - Supported Events.....	110
Table 16: Action URL - Supported Dynamic Variables.....	111
Table 17: Action URL Parameters P-values .....	112
Table 18: Action URL – Add Destination Settings .....	114
Table 19: Action URL - Destination P-values .....	114
Table 20: Action URL – Notification Options .....	115
Table 21: Action URL Notification – Events and Dynamic Attributes .....	116
Table 22: Action URL Notification P-values.....	120



## Table of Figures

Figure 1: GRP26XX Package Content.....	24
Figure 2: Phone Stand and Mounting Slots on the GRP26XX .....	25
Figure 3: Tab on the Handset Cradle .....	25
Figure 4: GRP26XX Back / Side View .....	26
Figure 5: Packet Capture in Idle .....	108
Figure 6: Packet Capture when running .....	108
Figure 7: Click-to-Dial Feature .....	109
Figure 8: Action URL Settings Page.....	111
Figure 9: Action URL Packet .....	112
Figure 10: Action URL - Add Destination.....	113
Figure 11: Action URL - Add Notification .....	115
Figure 12: GRP26xx Unified Firmware .....	122
Figure 13: Alternative Firmware - Rollback .....	123
Figure 14: Config File Download.....	125
Figure 15: Certificates Files Download .....	127
Figure 16: GRP26XX Tools .....	128
Figure 17: Factory Reset using LCD Menu.....	129



## DOCUMENT PURPOSE

This document describes how to configure GRP26XX features via phone's LCD menu and Web GUI menu. The intended audiences of this document are phone administrators.

To learn the basic functions of GRP2612 / GRP2612P / GRP2612W / GRP2613 / GRP2614 / GRP2615 / GRP2616, please visit <http://www.grandstream.com/support> to download the latest "GRP26XX User Guide".

This guide covers the following topics:

- [Product Overview](#)
- [Getting Started](#)
- [Configuration Guide](#)
- [BLF LED Patterns](#)
- [NAT Settings](#)
- [Bluetooth \(GRP2614/GRP2615/GRP2616 only\)](#)
- [Packet Capture](#)
- [Click-to-Dial](#)
- [Outbound Notification Support](#)
- [Upgrading and Provisioning](#)
- [GRP26XX Tools](#)
- [Restore Factory Default Settings](#)
- [Experiencing GRP26XX](#)



## CHANGE LOG

This section documents significant changes from previous versions of user manuals for GRP26XX. Only major new features or major document updates are listed here. Minor updates for corrections or editing are not documented here.

### **Firmware Version 1.0.1.17**

- Added the ability to add the MAC address to the User-Agent [MAC in User-Agent]
- Added support for Chile time zone. [Time Zone]
- Added support for new provision file. [Configuration File Download]

### **Firmware Version 1.0.1.7**

- Added support for GRP2615.
- Added support for GRP2616.

### **Firmware Version 1.0.0.31**

- Added Presence Event list mode to VPK/MPK modes. [Presence EventList]
- Added GDS DoorOpen mode to VPK/MPK modes. [GDS DoorOpen]
- Changed Screensaver Default value to “On if no VPK is active”. [Screensaver]

### **Firmware Version 1.0.0.16**

- This is the initial version for GRP26XX.



## GUI INTERFACE EXAMPLES

[http://www.grandstream.com/sites/default/files/Resources/GRP26XX\\_web\\_gui.zip](http://www.grandstream.com/sites/default/files/Resources/GRP26XX_web_gui.zip)

1. Screenshot of Login Page
2. Screenshots of Status Pages
3. Screenshots of Accounts Pages
4. Screenshots of Settings Pages
5. Screenshots of Network Pages
6. Screenshots of Maintenance Pages
7. Screenshots of Phonebook Pages



## WELCOME

Thank you for purchasing Grandstream GRP26XX Carrier-Grade IP Phones.

GRP2612/GRP2612P/GRP2612W is featuring 4 dual-color line keys (can be digitally programmed as up to 16 provisionable BLF/fast-dial keys), 2.4" (320x240) TFT color LCD, 4 programmable context-sensitive soft keys, 100M network ports, integrated PoE (GRP2612P & GRP2612W only), integrated dual-band WiFi (GRP2612W only), 3-way conference, and Electronic Hook Switch (EHS).

GRP2613 is featuring 6 dual-color line keys (can be digitally programmed as up to 24 provisionable BLF/fast-dial keys), 2.8" (320x240) TFT color LCD, 4 programmable context-sensitive soft keys, 1000M network ports, integrated PoE, 3-way conference, and Electronic Hook Switch (EHS).

GRP2614 is featuring 4 dual-color line keys (can be digitally programmed as up to 16 provisionable BLF/fast-dial keys), 2.8" (320x240) TFT color LCD, 4 programmable context-sensitive soft keys, 2.4" (320x240) additional screen dedicated to up to 24 multi-purpose keys, 1000M network ports, integrated PoE, Wi-Fi and Bluetooth support, 3-way conference and Electronic Hook Switch (EHS).

GRP2615 is featuring 10 dual-color line keys (can be digitally programmed as up to 40 provisionable BLF/fast-dial keys), 4.3" (480x272) TFT color LCD, 5 programmable context-sensitive soft keys, 1000M network ports, integrated PoE, Wi-Fi and Bluetooth support, 3-way conference and Electronic Hook Switch (EHS).

GRP2616 is a next generation enterprise IP Phone featuring 6 dual-color line keys (can be digitally programmed as up to 24 provisionable BLF/fast-dial keys), 4.3" (480x272) TFT color LCD, 5 programmable context-sensitive soft keys, 2.4" (320x240) additional screen dedicated to up to 24 multi-purpose keys, USB port, 1000M network ports, integrated PoE, Wi-Fi and Bluetooth support, 3-way conference and Electronic Hook Switch (EHS).

The GRP26XX series deliver superior HD audio quality, rich and leading-edge telephony features, protection for privacy, and broad interoperability with most 3<sup>rd</sup> party SIP devices and leading SIP/NGN/IMS platforms. GRP26XX series is the perfect choice for enterprise users looking for a high quality, feature rich multi-line executive IP phone with advanced functionalities and performance.





# PRODUCT OVERVIEW



## Feature Highlights

The following table contains the major features of the GRP26XX phones:

**Table 1: GRP26XX Features in a Glance**

	<p><b>GRP2612</b> <b>GRP2612P</b> <b>GRP2612W</b></p>	<ul style="list-style-type: none"> <li>• 4 dual-color line keys (can be digitally programmed as up to 16 provisionable BLF/fast-dial keys).</li> <li>• 2.4" (320x240) TFT color LCD.</li> <li>• 4 programmable context-sensitive soft keys.</li> <li>• 100M network ports.</li> <li>• Integrated PoE (GRP2612P &amp; GRP2612W only).</li> <li>• 3-way conference.</li> <li>• Electronic Hook Switch (EHS).</li> <li>• Wi-Fi support (GRP2612W only).</li> </ul>
	<p><b>GRP2613</b></p>	<ul style="list-style-type: none"> <li>• 6 dual-color line keys (can be digitally programmed as up to 24 provisionable BLF/fast-dial keys).</li> <li>• 2.8" (320x240) TFT color LCD.</li> <li>• 4 programmable context-sensitive soft keys.</li> <li>• 1000M network ports.</li> <li>• Integrated PoE.</li> <li>• 3-way conference.</li> <li>• Electronic Hook Switch (EHS).</li> </ul>
	<p><b>GRP2614</b></p>	<ul style="list-style-type: none"> <li>• 4 dual-color line keys (can be digitally programmed as up to 16 provisionable BLF/fast-dial keys).</li> <li>• 2.8" (320x240) TFT color LCD.</li> <li>• 4 programmable context-sensitive soft keys.</li> <li>• 2.4" (320x240) additional screen dedicated to up to 24 multi-purpose keys.</li> <li>• 1000M network ports.</li> <li>• Integrated PoE.</li> <li>• Wi-Fi and Bluetooth support.</li> <li>• 3-way conference.</li> <li>• Electronic Hook Switch (EHS).</li> </ul>



	<b>GRP2615</b>	<ul style="list-style-type: none"> <li>• 10 dual-color line keys (can be digitally programmed as up to 40 provisionable BLF/fast-dial keys).</li> <li>• 4.3" (480x272) TFT color LCD.</li> <li>• 5 programmable context-sensitive soft keys.</li> <li>• 1000M network ports.</li> <li>• Integrated PoE.</li> <li>• Wi-Fi and Bluetooth support.</li> <li>• 3-way conference.</li> <li>• Electronic Hook Switch (EHS).</li> </ul>
	<b>GRP2616</b>	<ul style="list-style-type: none"> <li>• 6 dual-color line keys (can be digitally programmed as up to 24 provisionable BLF/fast-dial keys).</li> <li>• 4.3" (480x272) TFT color LCD.</li> <li>• 5 programmable context-sensitive soft keys.</li> <li>• 2.4" (320x240) additional screen dedicated to up to 24 multi-purpose keys.</li> <li>• 1000M network ports.</li> <li>• Integrated PoE.</li> <li>• Wi-Fi and Bluetooth support.</li> <li>• 3-way conference.</li> <li>• Electronic Hook Switch (EHS).</li> </ul>

## Technical Specifications

The following table resumes all the technical specifications including the protocols / standards supported, voice codecs, telephony features, languages and upgrade/provisioning settings for the GRP26XX series.

**Table 2: GRP2612/GRP2612P/GRP2612W Technical Specifications**

<b>Protocols/Standards</b>	SIP RFC3261, TCP/IP/UDP, RTP/RTCP/RTCP-XR, HTTP/HTTPS, ARP, ICMP, DNS (A record, SRV, NAPTR), DHCP, PPPoE, SSH, TFTP, FTP/FTPS, NTP, STUN, SIMPLE, LLDP, LDAP, TR-069, 802.1x, TLS, SRTP, IPv6
<b>Network Interfaces</b>	Dual switched auto-sensing 10/100 Mbps Ethernet ports, with integrated PoE (only GRP2612P/GRP2612W)
<b>Graphic Display</b>	2.4 inch (320x240) TFT color LCD
<b>Feature Keys</b>	4 line keys with up to 2 SIP accounts, 4 programmable contexts sensitive Softkeys, 5 navigation/menu keys, 9 dedicated function keys for: MESSAGE (with LED indicator), TRANSFER, HOLD, HEADSET, MUTE, SEND/REDIAL, SPEAKERPHONE, VOLUME+, VOLUME-
<b>Voice Codec</b>	Support for G.729A/B, G723.1, G.711μ/a-law, G.726, G.722 (wide-band), OPUS, iLBC and in-band and out-of-band DTMF (in audio, RFC2833, SIP INFO)
<b>Auxiliary Ports</b>	RJ9 headset jack (allowing EHS with Plantronics headsets)



<b>Telephony Features</b>	Hold, transfer, forward, 3-way conference, call park, call pickup, shared-call-appearance (SCA), bridged-line-appearance (BLA), downloadable phonebook (XML, LDAP, up to 1000 items), call waiting, call log (up to 2000 records), customization of screen, off-hook auto dial, auto answer, click-to-dial, flexible dial plan, hot desking, personalized music ringtones and music on hold, server redundancy and fail-over
<b>HD audio</b>	Yes, both on handset and full-duplex handsfree speakerphone
<b>Base Stand</b>	Yes, allow 2 angle positions
<b>Wall Mountable</b>	Yes, (*wall mount sold separately)
<b>QoS</b>	Layer 2 (802.1Q, 802.1p) and Layer 3 (ToS, DiffServ, MPLS) QoS
<b>Security</b>	User and administrator level passwords, MD5 and MD5-sess based authentication, AES based secure configuration file, SRTP, TLS, 802.1x media access control
<b>Multi-language</b>	English, Arabic, Chinese, Croatian, Czech, Dutch, German, French, Hebrew, Hungarian, Italian, Japanese, Korean, Polish, Portuguese, Russian, Slovenia, Spanish, Turkish
<b>Upgrade/Provisioning</b>	Firmware upgrade via TFTP/FTP/FTPS/HTTP/HTTPS, mass provisioning using TR-069 or encrypted XML configuration file
<b>Power &amp; Green Energy Efficiency</b>	Universal power adapter included: Input:100-240 VAC; Output: +5VDC, 0.5A; Integrated Power-over-Ethernet (802.3af)
<b>Physical</b>	Dimension : 203mm x 193mm x 52.1mm Unit weight : 554g Package weight : 936g
<b>Temperature and Humidity</b>	32-104°F / 0~40°C, 10-90% (non- condensing)
<b>Package Content</b>	GRP2612/GRP2612P/GRP2612W phone, handset with cord, base stand, universal power supply (except GRP2612P), network cable, Quick Installation Guide
<b>Compliance</b>	<p><b>GRP2612/GRP2612P:</b>            FCC: FCC Part 15B, Class B; FCC Part 68 HAC.            CE: EN 55032; EN 55035; EN 61000-3-2; EN 61000-3-3; EN 62368-1.            RCM: AS/NZS CISPR 32; AS/NZS 62368.1; AS/CA S004.</p> <p><b>GRP2612W:</b>            FCC: FCC Part 15B, Class B; FCC Part 15 Subpart C; FCC Part 15 Subpart E; FCC Part 68 HAC.            CE: EN 55032; EN 55035; EN 61000-3-2; EN 61000-3-3; EN 62368-1; EN 301 489-1/-17; EN 300 328; EN 301 893; EN 62311;            RCM: AS/NZS CISPR 32; AS/NZS 62368.1; AS/NZS 4268; AS/CA S004.</p>



**Table 3: GRP2613 Technical Specifications**

<b>Protocols/Standards</b>	SIP RFC3261, TCP/IP/UDP, RTP/RTCP/RTCP-XR, HTTP/HTTPS, ARP, ICMP, DNS (A record, SRV, NAPTR), DHCP, PPPoE, SSH, TFTP, FTP/FTPS NTP, STUN, SIMPLE, LLDP, LDAP, TR-069, 802.1x, TLS, SRTP, IPv6
<b>Network Interfaces</b>	Dual switched auto-sensing 10/100/1000 Mbps Ethernet ports with integrated PoE
<b>Graphic Display</b>	2.8 inch (320x240) TFT color LCD
<b>Feature Keys</b>	6 line keys with up to 3 SIP accounts, 5 navigation/menu keys, 9 dedicated function keys for: MESSAGE (with LED indicator), TRANSFER, HOLD, HEADSET, MUTE, SEND/REDIAL, SPEAKERPHONE, VOLUME+, VOLUME-
<b>Voice Codec</b>	Support for G.723.1, G.729A/B, G.711 $\mu$ /a-law, G.726, G.722 (wide-band), OPUS, iLBC and in-band and out-of-band DTMF (in audio, RFC2833, SIP INFO)
<b>Auxiliary Ports</b>	RJ9 headset jack (allowing EHS with Plantronics headsets).
<b>Telephony Features</b>	Hold, transfer, forward, 3-way conference, call park, call pickup, shared-call-appearance (SCA)/bridged-line-appearance (BLA), downloadable phonebook (XML, LDAP, up to 1000 items), call waiting, call log (up to 2000 records), customization of screen, off-hook auto dial, auto answer, click-to-dial, flexible dial plan, hot desking, personalized music ringtones and music on hold, server redundancy and fail-over
<b>HD audio</b>	Yes, both on handset and full-duplex handsfree speakerphone
<b>Base Stand</b>	Yes, allow 2 angle positions
<b>Wall Mountable</b>	Yes, (*wall mount sold separately)
<b>QoS</b>	Layer 2 (802.1Q, 802.1p) and Layer 3 (ToS, DiffServ, MPLS) QoS
<b>Security</b>	User and administrator level passwords, MD5 and MD5-sess based authentication, AES based secure configuration file, SRTP, TLS, 802.1x media access control
<b>Multi-language</b>	English, Arabic, Chinese, Croatian, Czech, Dutch, German, French, Hebrew, Hungarian, Italian, Japanese, Korean, Polish, Portuguese, Russian, Slovenia, Spanish, Turkish
<b>Upgrade/Provisioning</b>	Firmware upgrade via TFTP/FTP/FTPS/HTTP/HTTPS, mass provisioning using TR-069 or encrypted XML configuration file
<b>Power &amp; Green Energy Efficiency</b>	Universal power adapter included: Input:100-240 VAC; Output: +5VDC, 0.5A; Integrated Power-over-Ethernet (802.3af) Max power consumption 6W.
<b>Physical</b>	Dimension : 203mm x 193mm x 52.1mm Unit weight : 554g Package weight : 936g
<b>Temperature and Humidity</b>	32-104°F / 0~40°C, 10-90% (non- condensing)



<b>Package Content</b>	GRP2613 phone, handset with cord, base stand, universal power supply, network cable, Quick Installation Guide
<b>Compliance</b>	FCC: FCC Part 15B, Class B; FCC Part 68 HAC. CE: EN 55032; EN 55035; EN 61000-3-2; EN 61000-3-3; EN 62368-1. RCM: AS/NZS CISPR 32; AS/NZS 62368.1; AS/CA S004.

**Table 4: GRP2614 Technical Specifications**

<b>Protocols/Standards</b>	SIP RFC3261, TCP/IP/UDP, RTP/RTCP/RTCP-XR, HTTP/HTTPS, ARP, ICMP, DNS (A record, SRV, NAPTR), DHCP, PPPoE, SSH, TFTP, FTP/FTPS, NTP, STUN, SIMPLE, LLDP, LDAP, TR-069, 802.1x, TLS, SRTP, IPv6
<b>Network Interfaces</b>	Dual switched auto-sensing 10/100/1000 Mbps Ethernet ports with integrated PoE
<b>Graphic Display</b>	2.8 inch (320x240) TFT color LCD – 2.4 inch MPK color LCD
<b>Bluetooth</b>	Yes, Bluetooth version 5
<b>Wi-Fi</b>	Yes, dual-band
<b>Feature Keys</b>	4 line keys with up to 4 SIP accounts, 24 speed-dial/BLF extension keys with dual-color LED, 4 programmable contexts sensitive Softkeys, 5 navigation/menu keys, 11 dedicated function keys for: MESSAGE (with LED indicator), PHONEBOOK, TRANSFER, CONFERENCE, HOLD, HEADSET, MUTE, SEND/REDIAL, SPEAKERPHONE, VOLUME+, VOLUME-
<b>Voice Codec</b>	Support for G.729A/B, G.711 $\mu$ /a-law, G.726, G.722 (wide-band), OPUS, iLBC and in-band and out-of-band DTMF (in audio, RFC2833, SIP INFO)
<b>Auxiliary Ports</b>	RJ9 headset jack (allowing EHS with Plantronics headsets).
<b>Telephony Features</b>	Hold, transfer, forward, 3-way conference, call park, call pickup, shared-call-appearance (SCA)/bridged-line-appearance (BLA), downloadable phonebook (XML, LDAP, up to 2000 items), call waiting, call log (up to 2000 records), customization of screen, off-hook auto dial, auto answer, click-to-dial, flexible dial plan, Hot Desking, personalized music ringtones and music on hold, server redundancy and fail-over
<b>HD audio</b>	Yes, both on handset and full-duplex handsfree speakerphone
<b>Base Stand</b>	Yes, allow 2 angle positions
<b>Wall Mountable</b>	Yes, (*wall mount sold separately)
<b>QoS</b>	Layer 2 (802.1Q, 802.1p) and Layer 3 (ToS, DiffServ, MPLS) QoS
<b>Security</b>	User and administrator level passwords, MD5 & MD5-sess based authentication, AES based secure configuration file, SRTP, TLS, 802.1x media access control
<b>Multi-language</b>	English, Arabic, Chinese, Croatian, Czech, Dutch, German, French, Hebrew, Hungarian, Italian, Japanese, Korean, Polish, Portuguese, Russian, Slovenia, Spanish, Turkish



<b>Upgrade/Provisioning</b>	Firmware upgrade via TFTP/FTP/FTPS/HTTP/HTTPS, mass provisioning using TR-069 or encrypted XML configuration file
<b>Power &amp; Green Energy Efficiency</b>	Universal power adapter included: Input:100-240V; Output: +12V, 0.5A; Integrated Power-over-Ethernet (802.3af) Max power consumption: 6W
<b>Physical</b>	Dimension : 234mm x 213mm x 82.2mm Unit weight : 950g Package weight : 1460g
<b>Temperature and Humidity</b>	32-104°F / 0~40°C, 10-90% (non- condensing)
<b>Package Content</b>	GRP2614 phone, handset with cord, base stand, universal power supply, network cable, Quick Installation Guide
<b>Compliance</b>	FCC: FCC Part 15B, Class B; FCC Part 15 Subpart C; FCC Part 15 Subpart E; FCC Part 68 HAC. CE: EN 55032; EN 55035; EN 61000-3-2; EN 61000-3-3; EN 62368-1; EN 301 489-1/-17; EN 300 328; EN 301 893; EN 62311; RCM: AS/NZS CISPR 32; AS/NZS 60950.1; AS/NZS 4268; AS/CA S004.

**Table 5: GRP2615 Technical Specifications**

<b>Protocols/Standards</b>	SIP RFC3261, TCP/IP/UDP, RTP/RTCP/RTCP-XR, HTTP/HTTPS, ARP, ICMP, DNS (A record, SRV, NAPTR), DHCP, PPPoE, SSH, TFTP, FTP/FTPS, NTP, STUN, SIMPLE, LLDP, LDAP, TR-069, 802.1x, TLS, SRTP, IPv6
<b>Network Interfaces</b>	Dual switched auto-sensing 10/100/1000 Mbps Ethernet ports with integrated PoE
<b>Graphic Display</b>	4.3 inch (480x272) TFT color LCD
<b>Bluetooth</b>	Yes, Bluetooth version 5
<b>Wi-Fi</b>	Yes, dual-band
<b>Feature Keys</b>	10 line keys with up to 5 SIP accounts, 40 speed-dial/BLF extension keys with dual-color LED, 5 programmable contexts sensitive Softkeys, 5 navigation/menu keys, 9 dedicated function keys for: MESSAGE (with LED indicator), TRANSFER, HOLD, HEADSET, MUTE, SEND/REDIAL, SPEAKERPHONE, VOLUME+, VOLUME-
<b>Voice Codec</b>	Support for G.729A/B, G.711μ/a-law, G.726, G.722 (wide-band), OPUS, iLBC and in-band and out-of-band DTMF (in audio, RFC2833, SIP INFO)
<b>Auxiliary Ports</b>	RJ9 headset jack (allowing EHS with Plantronics headsets), USB port.
<b>Telephony Features</b>	Hold, transfer, forward, 3-way conference, call park, call pickup, shared-call-appearance (SCA)/bridged-line-appearance (BLA), downloadable phonebook (XML, LDAP, up to 2000 items), call waiting, call log (up to 2000 records), customization of screen, off-hook auto dial, auto answer, click-to-dial, flexible dial



	plan, Hot Desking, personalized music ringtones and music on hold, server redundancy and fail-over
<b>HD audio</b>	Yes, both on handset and full-duplex handsfree speakerphone
<b>Extension Module</b>	Yes, can power up to 4 GBX20 modules which features 4.3" Color LCD, 20 quick-dial/BLF keys which dual-color LED, 2 navigation keys.
<b>Base Stand</b>	Yes, allow 2 angle positions
<b>Wall Mountable</b>	Yes, (*wall mount sold separately)
<b>QoS</b>	Layer 2 (802.1Q, 802.1p) and Layer 3 (ToS, DiffServ, MPLS) QoS
<b>Security</b>	User and administrator level passwords, MD5 & MD5-sess based authentication, AES based secure configuration file, SRTP, TLS, 802.1x media access control
<b>Multi-language</b>	English, Arabic, Chinese, Croatian, Czech, Dutch, German, French, Hebrew, Hungarian, Italian, Japanese, Korean, Polish, Portuguese, Russian, Slovenia, Spanish, Turkish
<b>Upgrade/Provisioning</b>	Firmware upgrade via TFTP/FTP/FTPS/HTTP/HTTPS, mass provisioning using TR-069 or encrypted XML configuration file
<b>Power &amp; Green Energy Efficiency</b>	Universal power adapter included: Input:100-240V; Output: +12V, 0.5A; Integrated Power-over-Ethernet (802.3af)
<b>Physical</b>	Dimensions : 243mm x 210mm x 82.3mm Unit weight:970g Package weight:1480g
<b>Temperature and Humidity</b>	32-104°F / 0~40°C, 10-90% (non- condensing)
<b>Package Content</b>	GRP2615 phone, handset with cord, base stand, universal power supply, network cable, Quick Installation Guide
<b>Compliance</b>	FCC: FCC Part 15B, Class B; FCC Part 15 Subpart C; FCC Part 15 Subpart E; FCC Part 68 HAC. CE: EN 55032; EN 55035; EN 61000-3-2; EN 61000-3-3; EN 62368-1; EN 301 489-1/-17; EN 300 328; EN 301 893; EN 62311; RCM: AS/NZS CISPR 32; AS/NZS 60950.1; AS/NZS 4268; AS/CA S004.

**Table 6: GRP2616 Technical Specifications**

<b>Protocols/Standards</b>	SIP RFC3261, TCP/IP/UDP, RTP/RTCP/RTCP-XR, HTTP/HTTPS, ARP, ICMP, DNS (A record, SRV, NAPTR), DHCP, PPPoE, SSH, TFTP, FTP/FTPS, NTP, STUN, SIMPLE, LLDP, LDAP, TR-069, 802.1x, TLS, SRTP, IPv6
<b>Network Interfaces</b>	Dual switched auto-sensing 10/100/1000 Mbps Ethernet ports with integrated PoE
<b>Graphic Display</b>	4.3 inch (480x272) TFT color LCD - 2.4 inch MPK color LCD
<b>Bluetooth</b>	Yes, Bluetooth version 5



<b>Wi-Fi</b>	Yes, dual-band
<b>Feature Keys</b>	6 line keys with up to 6 SIP accounts, 24 speed-dial/BLF extension keys with dual-color LED, 5 programmable contexts sensitive Softkeys, 5 navigation/menu keys, 11 dedicated function keys for: MESSAGE (with LED indicator), PHONEBOOK, TRANSFER, CONFERENCE, HOLD, HEADSET, MUTE, SEND/REDIAL, SPEAKERPHONE, VOLUME+, VOLUME-
<b>Voice Codec</b>	Support for G.729A/B, G.711 $\mu$ /a-law, G.726, G.722 (wide-band), OPUS, iLBC and in-band and out-of-band DTMF (in audio, RFC2833, SIP INFO)
<b>Auxiliary Ports</b>	RJ9 headset jack (allowing EHS with Plantronics headsets), USB port.
<b>Telephony Features</b>	Hold, transfer, forward, 3-way conference, call park, call pickup, shared-call-appearance (SCA)/bridged-line-appearance (BLA), downloadable phonebook (XML, LDAP, up to 2000 items), call waiting, call log (up to 2000 records), customization of screen, off-hook auto dial, auto answer, click-to-dial, flexible dial plan, Hot Desking, personalized music ringtones and music on hold, server redundancy and fail-over
<b>HD audio</b>	Yes, both on handset and full-duplex handsfree speakerphone
<b>Base Stand</b>	Yes, allow 2 angle positions
<b>Wall Mountable</b>	Yes
<b>QoS</b>	Layer 2 (802.1Q, 802.1p) and Layer 3 (ToS, DiffServ, MPLS) QoS
<b>Security</b>	User and administrator level passwords, MD5 & MD5-sess based authentication, AES based secure configuration file, SRTP, TLS, 802.1x media access control
<b>Multi-language</b>	English, <u>Arabic</u> , Chinese, Croatian, Czech, Dutch, German, French, Hebrew, <u>Hungarian</u> , Italian, Japanese, Korean, Polish, Portuguese, Russian, Slovenia, Spanish, Turkish
<b>Upgrade/Provisioning</b>	Firmware upgrade via TFTP/FTP/FTPS/HTTP/HTTPS, mass provisioning using TR-069 or encrypted XML configuration file
<b>Power &amp; Green Energy Efficiency</b>	Universal power adapter included: Input:100-240V; Output: +12V, 0.5A; Integrated Power-over-Ethernet (802.3af)
<b>Temperature and Humidity</b>	32-104°F / 0~40°C, 10-90% (non- condensing)
<b>Package Content</b>	GRP2616 phone, handset with cord, base stand, universal power supply, network cable, Quick Installation Guide
<b>Compliance</b>	FCC: FCC Part 15B, Class B; FCC Part 15 Subpart C; FCC Part 15 Subpart E; FCC Part 68 HAC. CE: EN 55032; EN 55035; EN 61000-3-2; EN 61000-3-3; EN 62368-1; EN 301 489-1/-17; EN 300 328; EN 301 893; EN 62311; RCM: AS/NZS CISPR 32; AS/NZS 60950.1; AS/NZS 4268; AS/CA S004.



## GETTING STARTED

This chapter provides basic installation instructions including the list of the packaging contents and also information for obtaining the best performance with the GRP26XX phone.

### Equipment Packaging

Table 7: Equipment Packaging

GRP26XX
<ul style="list-style-type: none"> <li>• 1 x GRP26XX Main Case.</li> <li>• 1 x Handset.</li> <li>• 1 x Phone Stand.</li> <li>• 1 x Ethernet Cable.</li> <li>• 1 x Power Adapter.</li> <li>• 1 x Phone cord.</li> <li>• 1 x Quick Installation Guide.</li> <li>• 1 x GPL License.</li> </ul>

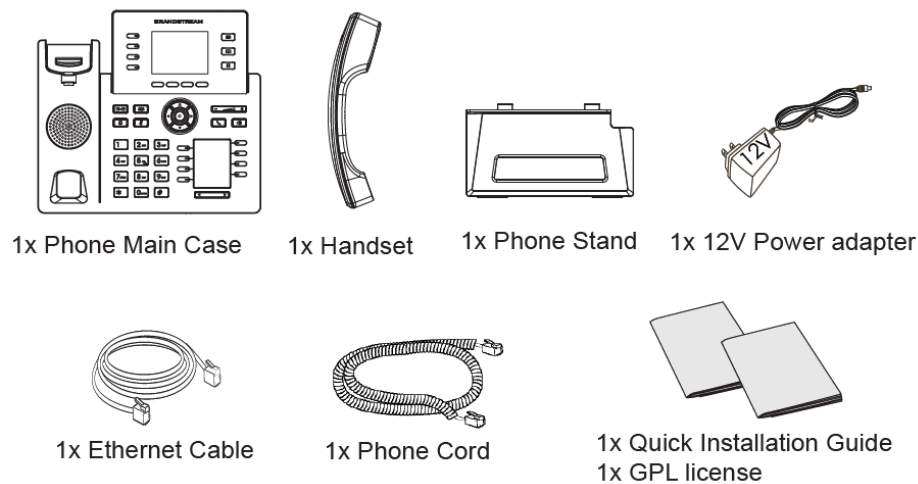

Figure 1: GRP26XX Package Content

**Note:** Check the package before installation. If you find anything missing, contact your system administrator.



## GRP26XX Phone Setup

The GRP26XX phones can be installed on the desktop using the phone stand or attached on the wall using the slots for wall mounting.

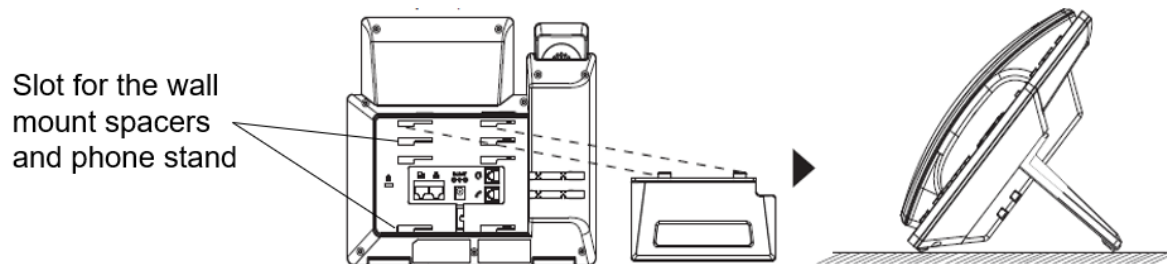

Figure 2: Phone Stand and Mounting Slots on the GRP26XX

### Using the Phone Stand

For installing the phone on the table with the phone stand, attach the phone stand to the bottom of the phone where there is a slot for the phone stand. (Upper half, bottom part).

### Using the Slots for Wall Mounting

1. Attach the wall mount spacers to the slot for wall mount spacers on the back of the phone.
2. Attach the phone to the wall via the wall mount hole.
3. Pull out the tab from the handset cradle (See figure below).
4. Rotate the tab and plug it back into the slot with the extension up to hold the handset while the phone is mounted on the wall (See figure below).

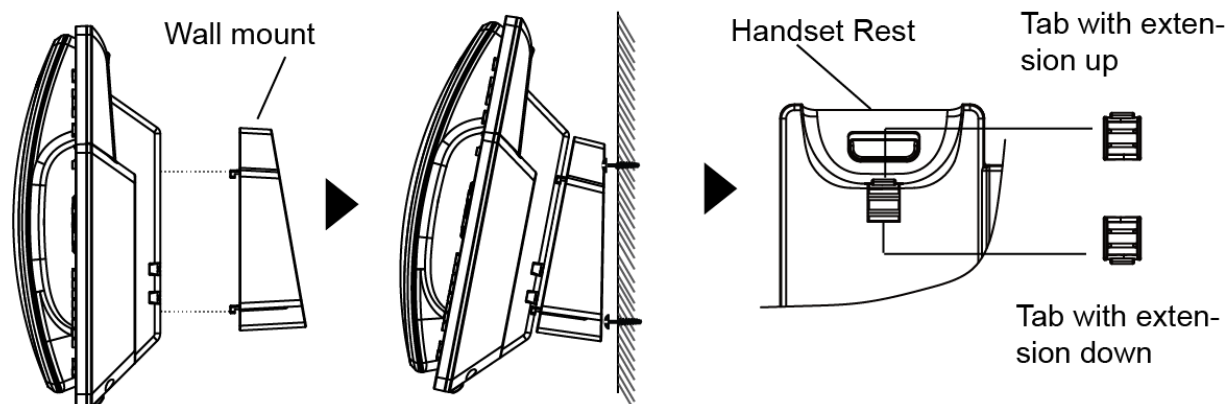

Figure 3: Tab on the Handset Cradle



## Connecting the GRP26XX

To setup the GRP26XX, follow the steps below:

1. Connect the handset and main phone case with the phone cord.
2. Connect the LAN port of the phone to the RJ-45 socket of a hub/switch or a router (LAN side of the router) using the Ethernet cable.
3. Connect the PSU output plug to the power jack on the phone; plug the power adapter into an electrical outlet. If PoE switch is used in step 2, this step could be skipped.
4. The LCD will display provisioning or firmware upgrade information. Before continuing, please wait for the date/time display to show up.
5. Using the phone embedded web server or keypad configuration menu, you can further configure the phone using either a static IP or DHCP.

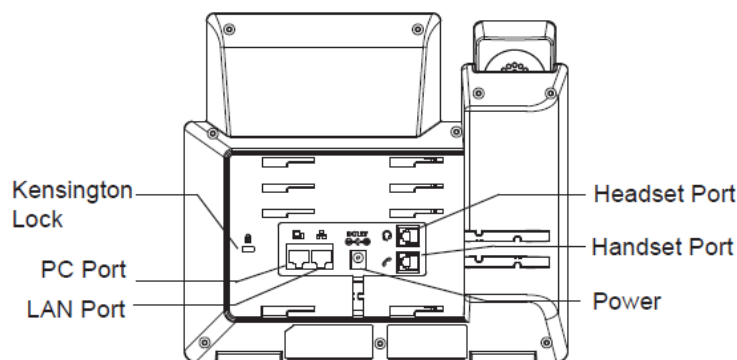

Figure 4: GRP26XX Back / Side View

## Configuration via Keypad

To configure the LCD menu using phone's keypad, follow the instructions below:

- **Enter MENU options.** When the phone is in idle, press the round MENU button to enter the configuration menu.
- **Navigate in the menu options.** Press the arrow keys up/down/left/right to navigate in the menu options.
- **Enter/Confirm selection.** Press the round MENU button or "Select" Softkey to enter the selected option.
- **Exit.** Press "Exit" Softkey to exit to the previous menu.
- **Return to Home page.**

In the Main menu, press Home Softkey to return home screen.

In sub menu, press and hold "Exit" Softkey until Exit Softkey changes to Home Softkey, then release the Softkey.

- The phone automatically exits MENU mode with an incoming call, when the phone is off hook or the MENU mode if left idle for more than 60 seconds.



- When the phone is in idle, pressing and holding the UP-navigation key for 3 seconds can see phone's IP address, IP setting, MAC address and software address.

The MENU options are listed in the following table.

**Table 8: Configuration Menu**

<b>Call History</b>	<p>Displays Local call logs:</p> <p>All Calls/Answered Calls/Dialed Calls/Missed Calls/Transferred Calls</p>
<b>Status</b>	<p>Displays account status, network status, software version number and Hardware</p> <ul style="list-style-type: none"> <li>• <b>Account status.</b></li> <li>• <b>Network status.</b></li> </ul> <p>Press to enter the sub menu for MAC address, IP setting information (DHCP/Static IP/PPPoE), Ipv4 address, Ipv6 address, Subnet Mask, Gateway and DNS server.</p> <ul style="list-style-type: none"> <li>• <b>System Information</b></li> </ul> <p>Press to enter the sub menu for Hardware version, P/N number. Boot, Core, Base, Prog version and IP Geographic Information.</p> <ul style="list-style-type: none"> <li>• <b>Provider Status</b></li> </ul> <p>Shows the provider's status based on the Special Feature set on each account. It provides also functions related to that specific provider.</p>
<b>Contacts</b>	<p><b>Contacts</b> sub menu includes the following options:</p> <ul style="list-style-type: none"> <li>• <b>Local Phonebook</b></li> <li>• <b>Local Group</b></li> <li>• <b>LDAP Directory</b></li> </ul> <p>Contacts sub menu is for Local Phonebook, Local Group, LDAP Directory and Broadsoft Phonebooks. User could configure phonebooks/groups/LDAP options here, download phonebook XML to the phone and search phonebook/LDAP directory.</p>
<b>Messages</b>	<p>Message sub menu include the following options:</p> <ul style="list-style-type: none"> <li>• <b>Instant Message</b></li> </ul> <p>Displays received instant messages;</p> <ul style="list-style-type: none"> <li>• <b>Voice Mails</b></li> </ul> <p>Displays voicemail message information in the format below: new messages/all messages (urgent messages/all urgent messages).</p>

**Preference** sub menu includes the following options:

- **Do Not Disturb**

Enables/disables Do Not Disturb on the phone.

- **Keypad Lock**

Turns on/off keypad lock feature and configures keypad lock password. The default keypad lock password is null. If user enabled Star Key lock without configuring password, user can unlock keypad by holding \* key 4 seconds and pressing “OK” button.

- **Sounds**

- **Ring Tone**

Configures different ring tones for incoming call.

- **Ring Volume**

Adjusts ring volume by pressing left/right arrow key.

- **Appearance**

- **Active LCD Brightness**

Adjusts active LCD brightness by pressing left/right arrow key

- **Idle LCD Brightness**

Adjusts idle LCD brightness by pressing left/right arrow key

- **Active LCD Timeout**

Adjusts the minute of active backlight timeout.

- **Screensaver**

Enables/Disables Screensaver

- **Screensaver Timeout**

Configures the minutes of idle before the screensaver activates.  
Valid range is 3 to 60.

- **MPK LCD Settings (Available on GRP2614/GRP2616 only)**

- **MPK LCD Display Order**

Choose MPK LCD Display Order whether to be Sequential or Alternating

- **Display Contact on MPK LCD**

Enable / Disable Display Contact on MPK Order

- **Language and Input**

- **Display Language**

Selects the language to be displayed on the phone’s LCD. Users could select Automatic for local language based on IP location if available. By default, it is Auto.



	<ul style="list-style-type: none"> <li>○ <b>Default Input Selection</b>          Selects the Input mode from <b>Multi-Tap</b> and <b>Shiftable</b>. By default, it is <b>Multi-Tap</b>.  <b>Multi-Tap:</b> User may tap the same key multiple times to switch to the desired character.  <b>Shiftable:</b> After pressing the number button, user will see the IDs of the characters that matching to the button. User can select the desired character by entering the corresponding ID on keypad.</li> <li>● <b>Date Time</b> <ul style="list-style-type: none"> <li>○ <b>Allow DHCP Option 42 to override NTP server</b></li> <li>○ <b>Allow DHCP Option 2 to override Time Zone setting</b></li> <li>○ <b>Time Settings</b></li> </ul>           It is used to configure date and time on the phone.         </li> <li>● <b>Search Mode</b>            Specifies the phonebook search mode to <b>QuickMatch</b> or <b>ExactMatch</b>. By default, it is <b>QuickMatch</b>.         </li> </ul>
<b>Phone</b>	<p><b>Phone</b> sub menu includes the following options:</p> <ul style="list-style-type: none"> <li>● <b>SIP</b>            Configures SIP Proxy, Outbound Proxy, SIP User ID, SIP Auth ID, SIP Password, SIP Transport and Audio information to register SIP account on the phone.</li> <li>● <b>Call Features</b>            Configures call forward features for Forward All, Forward Busy, Forward No Answer and No Answer Timeout.</li> </ul>
<b>System</b>	<p><b>System</b> sub menu includes the following options:</p> <ul style="list-style-type: none"> <li>● <b>Network</b> <ul style="list-style-type: none"> <li>○ <b>Internet Protocol</b>                Selects Prefer IPv4 / Prefer IPv6 / IPv4 only or IPv6 only. The default setting is "Prefer IPv4".</li> <li>○ <b>IP Setting</b>                Selects IP mode (DHCP/Static IP/PPPoE); Configures PPPoE account ID and password; Configures static IP address, Netmask, Gateway, DNS Server 1 and DNS Server 2.</li> <li>○ <b>802.1X</b>                Enables/Disables 802.1X mode; Configures 802.1x identity and MD5 password.</li> </ul> </li> </ul>



- **Layer 2 QoS**

Configures 802.1Q/VLAN Tag and priority value. Select “Reset VLAN Config” to reset VLAN configuration.

- **Wi-Fi Settings (GRP2612W & GRP2614 & GRP2615 & GRP2616 only)**

- **Enables/disables Wi-Fi**

Enables/disables Wi-Fi

- **Scan**

Scan available Wi-Fi networks.

- **Bluetooth Settings (GRP2614/GRP2615 & GRP2616 only)**

- **Bluetooth Status**

Displays the status of Bluetooth

- **Bluetooth MAC**

Displays the GRP phone’s Bluetooth MAC address.

(Bluetooth MAC address is GRP phone’s MAC address plus 1)

- **Power**

Turns on/off the Bluetooth feature.

- **Handsfree Mode**

Enables/Disables Handsfree mode

- **Bluetooth Name**

Specifies GRP phone name when discovered by other Bluetooth devices.

- **Start Scan**

Starts to scan other Bluetooth devices around the phone. If found, user could press “Pair” Softkey, and enter Pin code to pair to other Bluetooth devices.

- **Web Access**

- **Web Access Mode**

- **HTTP web port**

- **HTTPs web port**

- **Upgrade**

- **Firmware Server**

Configures firmware server for upgrading the phone.

- **Config Server**

Configures config server for provisioning the phone.



- **Upgrade Via**

Specifies upgrade/provisioning via TFTP/FTP/FTPS/HTTP/HTTPS.

- **Start Provision**

Starts Provision immediately.

- **Language Download**

- **Auto Language Download**

- **Language Download**

- **Factory Functions**

- **Diagnostic Mode**

All LEDs will light up. All keys' name will display in red on LCD screen before diagnosing. Press any key on the keypad to diagnose the key's function. When done, the key's name will display in blue on LCD. Lift and put back the handset to exit diagnostic mode.

- **Audio Loopback**

Speak to the phone using speaker/handset/headset. If you can hear your voice, your audio is working fine. Press "Exit" Softkey to exit audio loopback mode.

- **LCD on/off**

Selects this option to turn off LCD. Press any button to turn on LCD.

- **LCD Diagnostic**

Enters this option and press Left/Right Navigation key to do LCD Diagnostic. Press "Exit" Softkey to quit.

- **Certificate Verification**

This is used to validate certificate chain for the server's certificate.

- **UCM Detect**

Detect/connect UCM server to process auto-provision. Manually input the IP and port of the UCM server phone wants to bind with; Or select from the available UCM server in network.

- **Authentication**

- **Admin Password**

This is used to change the admin password for Web UI access.



	<ul style="list-style-type: none"><li>○ <b>End User Password</b> This is used to change end user password for Web UI access.</li><li>○ <b>Settings</b> Turns on/off Test Password Strength feature. This will allow only passwords with some constraints to ensure better security.</li><li>• <b>Operations</b><ul style="list-style-type: none"><li>○ <b>Factory Reset</b> It is used to restore the phone to factory default settings.</li><li>○ <b>Ping and Traceroute</b> It is used to show the route taken by packets across to an URL.</li><li>○ <b>Alternative firmware</b> It is used to show current and alternative firmware versions available on the phone. Users can “rollback” to alternative firmware from this menu.</li></ul></li></ul>
<b>Reboot</b>	Reboots the phone.



The following picture shows the keypad MENU configuration flow:

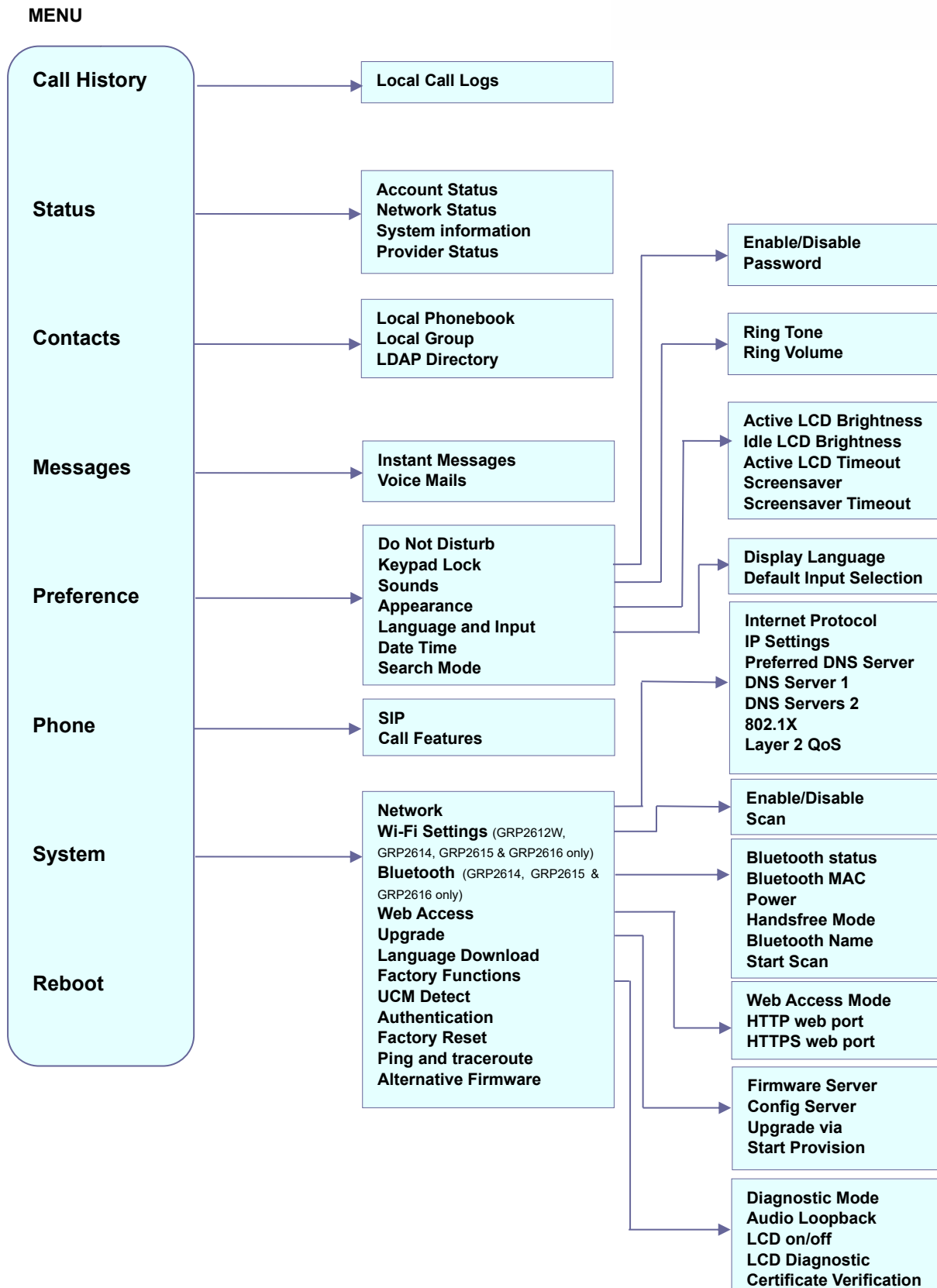

## Configuration via Web Browser

The GRP26XX embedded Web server responds to HTTP/HTTPS GET/POST requests. Embedded HTML pages allow a user to configure the IP phone through a Web browser such as Google Chrome, Mozilla Firefox and Microsoft's IE. To access the Web GUI:

1. Connect the computer to the same network as the phone.
2. Make sure the phone is turned on and shows its IP address. You may check the IP address by pressing and holding UP arrow button for 3 seconds when phone is at idle state.
3. Open a Web browser on your computer.
4. Enter the phone's IP address in the address bar of the browser.
5. Enter the administrator's login and password to access the Web Configuration Menu.

### Notes:

- The computer must be connected to the same sub-network as the phone. This can be easily done by connecting the computer to the same hub or switch as the phone connected to. In absence of a hub/switch (or free ports on the hub/switch), please connect the computer directly to the PC port on the back of the phone;
- If the phone is properly connected to a working Internet connection, the IP address of the phone will display in MENU→Status→Network Status. This address has the format: xxx.xxx.xxx.xxx, where xxx stands for a number from 0-255. Users will need this number to access the Web GUI. For example, if the phone has IP address 192.168.40.154, please enter "http://192.168.40.154" in the address bar of the browser;
- There are two default passwords for the login page:

User Level	User	Password	Web Pages Allowed
End User Level	user	123	Only Status and Basic Settings
Administrator Level	admin	Random password available on the sticker at the back of the unit.	Browse all pages

- When changing any settings, always SUBMIT them by pressing the "Save" or "Save and Apply" button on the bottom of the page. If the change is saved only but not applied, after making all the changes, click on the "APPLY" button on top of the page to submit. After submitting the changes in all the Web GUI pages, reboot the phone to have the changes take effect if necessary (All the options under "Accounts" page and "Phonebook" page do not require reboot. Most of the options under "Settings" page do not require reboot).



## **Saving Configuration Changes**

After users makes changes to the configuration, press the "Save" button will save but not apply the changes until the "Apply" button on the top of web GUI page is clicked. Or, users could directly press "Save and Apply" button. We recommend rebooting or powering cycle the phone after applying all the changes.

## **Rebooting from Remote Locations**

Press the "Reboot" button on the top right corner of the web GUI page to reboot the phone remotely. The web browser will then display a reboot message. Wait for about 1 minute to log in again.



## CONFIGURATION GUIDE

This section describes the options in the phone's Web GUI. As mentioned, you can log in as an administrator or an end user.

- **Status:** Displays the Account status, Network status, and System Info of the phone.
- **Account:** To configure the SIP account.
- **Settings:** To configure call features, ring tone, audio control, LCD display, date and time, Web services, XML applications, programmable keys etc.
- **Network:** To configure network settings.
- **Maintenance:** To configure web access, upgrading and provisioning, syslog, language settings, TR-069, security etc.
- **Directory:** To manage Phonebook and LDAP.

### Status Page Definitions

Table 9: Status Page Definitions

Status → Account Status	
<b>Account</b>	Account index. <ul style="list-style-type: none"> <li>• For GRP2612/GRP2612P/GRP2612W: up to 2 SIP accounts</li> <li>• For GRP2613: up to 3 SIP accounts</li> <li>• For GRP2614: up to 4 SIP accounts</li> <li>• For GRP2615: up to 5 SIP accounts</li> <li>• For GRP2616: up to 6 SIP accounts</li> </ul>
<b>SIP User ID</b>	Displays the configured SIP User ID for the account.
<b>SIP Server</b>	Displays the configured SIP Server address, URL or IP address, and port of the SIP server.
<b>SIP Registration</b>	Displays SIP registration status for the SIP account, it will display Yes/No with Green/Red background.
Status → Network Status	
<b>MAC Address</b>	Global unique ID of device, in HEX format. The MAC address will be used for provisioning and can be found on the label coming with original box and on the label located on the back of the device.
<b>IP Setting</b>	The configured address type: DHCP, Static IP or PPPoE.
<b>IPv4 Address</b>	The IPv4 address obtained on the phone.
<b>IPv6 Address</b>	The IPv6 address obtained on the phone.



<b>OpenVPN® IP</b>	The OpenVPN® IP obtained on the phone.
<b>Subnet Mask</b>	The subnet mask obtained on the phone.
<b>Gateway</b>	The gateway address obtained on the phone.
<b>DNS Server 1</b>	The DNS server address 1 obtained on the phone.
<b>DNS Server 2</b>	The DNS server address 2 obtained on the phone.
<b>Affinity Broadcast</b>	The status of Affinity Broadcast on the phone. (Available on GRP2614, GRP2615 & GRP2616 only).
<b>PPPoE Link Up</b>	PPPoE connection status.
<b>NAT Type</b>	The type of NAT connection used by the phone.
<b>NAT Traversal</b>	Display the status of NAT connection for each account on the phone.
<b>Status → System Info</b>	
<b>Product Model</b>	Product model of the phone.
<b>Part Number</b>	Product part number.
<b>Software Version</b>	<ul style="list-style-type: none"> <li>• <b>Boot:</b> boot version number;</li> <li>• <b>Core:</b> core version number;</li> <li>• <b>Base:</b> base version number;</li> <li>• <b>Prog:</b> program version number. This is the main firmware release number, which is always used for identifying the software system of the phone;</li> <li>• <b>Locale:</b> locale version number;</li> <li>• <b>Recovery:</b> recovery version number.</li> </ul>
<b>IP Geographic Information</b>	<ul style="list-style-type: none"> <li>• <b>City:</b> displaying phone location;</li> <li>• <b>Language:</b> displaying language;</li> <li>• <b>Time Zone:</b> displaying time zone;</li> <li>• <b>Country Code:</b> displaying country code for Wi-Fi; (Available on GRP2612W &amp; GRP2614 &amp; GRP2615 &amp; GRP2616 only)</li> </ul>
<b>Special Feature</b>	<ul style="list-style-type: none"> <li>• <b>OpenVPN® Support:</b> displaying if the phone supports OpenVPN®.</li> </ul>
<b>System Up Time</b>	System up time since the last reboot.
<b>System Time</b>	Current system time on the phone system.
<b>Service Status</b>	GUI, Phone and CPE service status.



<b>System Information</b>	Download system information
<b>User Space</b>	Shows the percentage of the user space used and the status of the Database
<b>Core Dump</b>	Shows the status of the core dump and the core dump files generated if any. It also gives the ability to generate GUI/Phone core dump files manually.
<b>Screenshot</b>	Download captured screenshots. Press "Start" button to clear screenshots.
<b>Status → Programmable Keys Status → Virtual Multi-Purpose Keys</b>	
<b>VPKs Status</b>	<ul style="list-style-type: none"> <li>• Mode</li> <li>• Account</li> <li>• Description</li> <li>• Value</li> </ul>
<b>Status → Programmable Keys Status → Multi-Purpose Keys</b>	
<b>MPKs Status</b>	<ul style="list-style-type: none"> <li>• Mode</li> <li>• Account</li> <li>• Description</li> <li>• Value</li> </ul>
<b>Status → Programmable Keys Status → Softkeys</b>	
<b>Softkeys</b>	<ul style="list-style-type: none"> <li>• Mode</li> <li>• Account</li> <li>• Description</li> <li>• Value</li> </ul>

## Account Page Definitions

**Table 10: Account Page Definitions**

<b>Account x → General Settings</b>	
<b>Account Active</b>	This field indicates whether the account is active. The default setting is "No".
<b>Account Name</b>	The name associated with each account to be displayed on the LCD.
<b>SIP Server</b>	The URL or IP address, and port of the SIP server. This is provided by your VoIP service provider (ITSP).
<b>Secondary SIP Server</b>	The URL or IP address, and port of the SIP server. When configured, phone will register to both Primary and Secondary SIP Server. If Primary SIP Server is not reachable then the phone will use Secondary SIP Server for phone services (including making/receiving calls).



<b>Outbound Proxy</b>	IP address or Domain name of the Primary Outbound Proxy, Media Gateway, or Session Border Controller. It's used by the phone for Firewall or NAT penetration in different network environments. If a symmetric NAT is detected, STUN will not work and ONLY an Outbound Proxy can provide a solution.
<b>Backup Outbound Proxy</b>	IP address or Domain name of the Secondary Outbound Proxy which will be used when the primary proxy cannot be connected.
<b>BLF Server</b>	Optional server used for SUBSCRIBE requests to indicate other extensions status on the SIP server.
<b>SIP User ID</b>	User account information provided by your VoIP service provider (ITSP). It's usually in the form of digits like phone number or actually a phone number.
<b>Authenticate ID</b>	SIP service subscriber's Authenticate ID used for authentication. It can be identical to or different from the SIP User ID.
<b>Authenticate Password</b>	The account password required for the phone to authenticate with the ITSP (SIP) server before the account can be registered. After it is saved, this will appear as hidden for security purpose.
<b>Name</b>	The SIP server subscriber's name (optional) that will be used for Caller ID display.
<b>Voice Mail Access Number</b>	This parameter allows you to access voice messages by pressing the MESSAGE button on the phone. This ID is usually the VM portal access number. For example, in UCM6xxx IPPBX, *97 could be used.
<b>Picture</b>	Specifies account's picture that will be sent to the caller/callee when making calls.
<b>Account Display</b>	This option allows you to configure how your SIP account label will be displayed on the phone's screen. If set to "Username", LCD account label will display the Account Name configured for this SIP account. If set to "User ID", it will then display the SIP User ID configured for this SIP account.

#### Account x → Dial Plan

<b>Name</b>	Enter the name for the configured rules.
<b>Rule</b>	Enter the rule settings (number pattern, prefix to add ...etc).
<b>Type</b>	Choose the type of the rule (pattern, block, dial now, prefix & second tone).

#### Account x → Network Settings

<b>DNS Mode</b>	This parameter controls how the Search Appliance looks up IP addresses for hostnames. There are four modes: A Record, SRV, NATPTR/SRV, Use Configured IP. The default setting is "A Record".
-----------------	--



	<p>If the user wishes to locate the server by DNS SRV, the user may select “SRV” or “NATPTR/SRV”.</p> <p>If “Use Configured IP” is selected, please fill in the three fields below:</p> <ul style="list-style-type: none"> <li>• <b>Primary IP</b></li> <li>• <b>Backup IP 1</b></li> <li>• <b>Backup IP 2</b></li> </ul> <p>If SIP server is configured as domain name, phone will not send DNS query, but use “Primary IP” or “Backup IP x” to send SIP message if at least one of them are not empty.</p> <p>Phone will try to use “Primary IP” first. After 3 tries without any response, it will switch to “Backup IP x”, and then it will switch back to “Primary IP” after 3 re-tries.</p> <p>If SIP server is already an IP address, phone will use it directly even “User Configured IP” is selected.</p>
<b>DNS SRV Fail-over Mode</b>	<p>The option will decide which IP is going to be used in sending SIP packets after IPs for SIP server host are resolved with DNS SRV.</p> <ul style="list-style-type: none"> <li>• <b>Default</b></li> </ul> <p>If the option is set with “default”, it will again try to send register messages to one IP at a time, and the process repeats.</p> <ul style="list-style-type: none"> <li>• <b>Saved one until DNS TTL</b></li> </ul> <p>If the option is set with “Saved one until DNS TTL”, it will send register messages to the previously registered IP first. If no response, it will try to send one at a time for each IP. This behavior lasts if DNS TTL (time-to-live) is up.</p> <ul style="list-style-type: none"> <li>• <b>Saved one until no responses</b></li> </ul> <p>If the option is set with “Saved one until no responses”, it will send register messages to the previously registered IP first, but this behavior will persist until the registered server does not respond.</p>
<b>Primary IP</b>	<p>Configures the primary IP address where the phone sends DNS query to when “Use Configured IP” is selected for DNS mode.</p>
<b>Backup IP 1</b>	<p>Configures the backup IP1 address where the phone sends DNS query to when “Use Configured IP” is selected for DNS mode.</p>
<b>Backup IP 2</b>	<p>Configures the backup IP2 address where the phone sends DNS query to when “Use Configured IP” is selected for DNS mode.</p>





<b>NAT Traversal</b>	<p>This parameter configures whether the NAT traversal mechanism is activated. Users could select the mechanism from No, STUN, Keep-alive, UPnP, Auto or VPN. The default setting is “Auto”.</p> <p>If set to “STUN” and STUN server is configured, the phone will route according to the STUN server. If NAT type is Full Cone, Restricted Cone or Port-Restricted Cone, the phone will try to use public IP addresses and port number in all the SIP&amp;SDP messages.</p> <p>The phone will send empty SDP packet to the SIP server periodically to keep the NAT port open if it is configured to be “Keep-alive”. Configure this to be “No” if an outbound proxy is used. “STUN” cannot be used if the detected NAT is symmetric NAT. Set this to “VPN” if OpenVPN is used.</p>
<b>Proxy-Require</b>	<p>A SIP Extension to notify the SIP server that the phone is behind a NAT/Firewall. Do not configure this parameter unless this feature is supported on the SIP server.</p>
<b>Use SBC</b>	<p>Indicate whether or not an SBC server is used. If users want to work under SBC associated with 3CX, they should enable this feature to have better communication with the server.</p>
<b>Account x → SIP Settings → Basic Settings</b>	
<b>TEL URI</b>	<p>If the phone has an assigned PSTN telephone number, this field should be set to “User=Phone”.</p> <p>Then a “User=Phone” parameter will be attached to the Request-Line and “TO” header in the SIP request to indicate the E.164 number.</p> <p>If set to “Enable”, “Tel:” will be used instead of “SIP:” in the SIP request. The default setting is “Disabled”.</p>
<b>SIP Registration</b>	<p>Selects whether the phone will send SIP Register messages to the proxy/server. The default setting is “Yes”.</p>
<b>Unregister On Reboot</b>	<p>Allows the SIP user’s registration information to be cleared when the phone reboots. The SIP REGISTER message will contain “Expires: 0” to unbind the connection. Three options are available: The default setting is “No”.</p> <ul style="list-style-type: none"> <li>• If set to “<b>All</b>”, the SIP user’s registration information will be cleared when the phone reboots. The SIP Contact header will contain “*” to notify the server to unbind the connection.</li> <li>• If set to “<b>Instance</b>”, the SIP user will be unregistered on current phone only.</li> <li>• If set to “<b>No</b>”, the phone will not unregister the SIP account when rebooting.</li> </ul>
<b>Register Expiration</b>	<p>Specifies the frequency (in minutes) in which the phone refreshes its registration with the specified registrar. The default value is 60 minutes. The maximum value is 64800 minutes (about 45 days).</p>



<b>Subscribe Expiration</b>	Specifies the frequency (in minutes) in which the phone refreshes its subscription with the specified registrar. The maximum value is 64800 (about 45 days). The default value is 60 minutes.
<b>Reregister Before Expiration</b>	Specifies the time frequency (in seconds) that the phone sends re-registration request before the Register Expiration. The default value is 0.
<b>Enable OPTIONS Keep Alive</b>	Enable OPTIONS Keep Alive to check SIP Server. Default is “Yes”.
<b>OPTIONS Keep Alive Interval</b>	Time interval for OPTIONS Keep Alive feature in seconds. Default is “30” seconds.
<b>OPTIONS Keep Alive Max Lost</b>	Number of max lost packets for OPTIONS Keep Alive feature before the phone re-registration. Default is “3”.
<b>Local SIP Port</b>	Defines the local SIP port used to listen and transmit. The default value is 5060 for Account 1, 5062 for Account 2, 5064 for Account 3, 5066 for Account 4, 5068 for Account 5, 5070 for Account 6. The valid range is from 1 to 65535.
<b>SIP Registration Failure Retry Wait Time</b>	Specifies the interval to retry registration if the process is failed. The valid range is 1 to 3600. The default value is 20 seconds.
<b>SIP T1 Timeout</b>	SIP T1 Timeout is an estimate of the round-trip time of transactions between a client and server. If no response is received the timeout is increased, and request re-transmit retries would continue until a maximum amount of time define by T2. The default setting is 0.5 seconds.
<b>SIP T2 Timeout</b>	SIP T2 Timeout is the maximum retransmit time of any SIP request messages (excluding the INVITE message). The re-transmitting and doubling of T1 continues until it reaches the T2 value. Default is 4 seconds.
<b>SIP Transport</b>	Determines the network protocol used for the SIP transport. Users can choose from TCP, UDP and TLS. The default setting is “UDP”.
<b>SIP Listening Mode</b>	<p>Determines whether or not to listen to multiple SIP protocols.</p> <ul style="list-style-type: none"> <li>• <b>Transport Only:</b> will listen to configured transport protocol only.</li> <li>• <b>Dual:</b> will listen to TCP when UDP is selected.</li> <li>• <b>Dual (Secured):</b> will listen to TLS/TCP when UDP is selected. If TCP or TLS/TCP is selected, UDP will be listened to</li> <li>• <b>Dual (BLF Enforced):</b> will try to enforce BLF subscriptions to use TCP protocol by adding 'transport=tcp' to the Contact header.</li> </ul> <p>The default setting is “Transport Only”.</p>
<b>SIP URI Scheme when using TLS</b>	Specifies if “sip” or “sips” will be used when TLS/TCP is selected for SIP Transport. The default setting is “sips”.



<b>Use Actual Ephemeral Port in Contact with TCP/TLS</b>	<p>This option is used to control the port information in the Via header and Contact header. If set to No, these port numbers will use the permanent listening port on the phone. Otherwise, they will use the ephemeral port for the connection.</p> <p>The default setting is “No”.</p>
<b>Outbound Proxy Mode</b>	<p>The Outbound proxy mode is placed in the route header when sending SIP messages, or they can be always sent to outbound proxy.</p> <ul style="list-style-type: none"> <li>• <b>In route</b></li> <li>• <b>Not in route</b></li> <li>• <b>Always send to</b></li> </ul> <p>Default is “in route”.</p>
<b>Support SIP Instance ID</b>	<p>Defines whether SIP Instance ID is supported or not. Default setting is “Yes”.</p>
<b>SUBSCRIBE for MWI</b>	<p>When set to “Yes”, a SUBSCRIBE for Message Waiting Indication will be sent periodically. The phone supports synchronized and non-synchronized MWI. The default setting is “No”.</p>
<b>SUBSCRIBE for Registration</b>	<p>When set to “Yes”, a SUBSCRIBE for Registration will be sent out periodically. The default setting is “No”.</p>
<b>Enable 100rel</b>	<p>The use of the PRACK (Provisional Acknowledgment) method enables reliability to SIP provisional responses (1xx series). This is very important to support PSTN interworking. To invoke a reliable provisional response, the 100rel tag is appended to the value of the required header of the initial signaling messages. The default setting is “No”.</p>
<b>Callee ID Display</b>	<p>Determines from where to locate callee ID to display or not on the phone.</p> <ul style="list-style-type: none"> <li>• <b>Auto:</b> The phone will update the callee ID in the order of P-Asserted Identity Header, Remote-Party-ID Header and To Header in the 180 Ringing.</li> <li>• <b>Disabled:</b> Callee ID will be displayed as “Unavailable”.</li> <li>• <b>To Header:</b> Callee ID will not be updated and displayed as To Header.</li> </ul> <p>The default setting is “Auto”.</p>
<b>Caller ID Display</b>	<p>Determines from where to locate caller ID to display or not on the phone</p> <ul style="list-style-type: none"> <li>• <b>Auto:</b> The phone will look for the caller ID in the order of P-Asserted Identity Header, Remote-Party-ID Header and From Header in the incoming SIP INVITE.</li> <li>• <b>Disabled:</b> All incoming calls are displayed with “Unavailable”.</li> <li>• <b>From Header:</b> the phone will display the caller ID based on the From Header in the incoming SIP INVITE.</li> </ul> <p>The default setting is “From Header”.</p>



<b>Add Auth Header on Initial REGISTER</b>	To define whether authorization Header will be added on initial REGISTER from the first REGISTER. The default setting is “No”.
<b>Allow SIP Reset</b>	This is used to perform a factory reset through SIP NOTIFY. When the phone receives the NOTIFY with <b>Event: reset</b> , the phone should perform a factory reset after the authentication. The default setting is “No”.
<b>Ignore Alert-Info header</b>	This option is used to configure default ringtone. If set to “Yes”, configured default ringtone will be played. The default setting is “No”.
<b>Account x → SIP Settings → Custom SIP Headers</b>	
<b>Use Privacy Header</b>	<p>Controls whether the Privacy header will present in the SIP INVITE message or not, whether the header contains the caller info.</p> <ul style="list-style-type: none"> <li>• <b>Default:</b> The Privacy Header will show in INVITE only when “Huawei IMS” special feature is on.</li> <li>• <b>Yes:</b> The Privacy Header will always show in INVITE.</li> <li>• <b>No:</b> The Privacy Header will not show in INVITE.</li> </ul> <p>The default setting is “default”.</p>
<b>Use P-Preferred-Identity Header</b>	<p>Controls whether the P-Preferred-Identity Header will present in the SIP INVITE message.</p> <ul style="list-style-type: none"> <li>• <b>Default:</b> The P-Preferred-Identity Header will show in INVITE unless “Huawei IMS” special feature is on.</li> <li>• <b>Yes:</b> The P-Preferred-Identity Header will always show in INVITE.</li> <li>• <b>No:</b> The P-Preferred-Identity Header will not show in INVITE.</li> </ul> <p>The default setting is “default”.</p>
<b>Use X-Grandstream-PBX Header</b>	Enables / disables the use of X-Grandstream-PBX header in SIP request. When disabled, the SIP message sent from the phone will not include the selected header. Default setting is “Yes”.
<b>Use P-Access-Network-Info Header</b>	Enables / disables the use of P-Access-Network-Info header in SIP request. When disabled, the SIP message sent from the phone will not include the selected header. Default setting is “Yes”.
<b>Use P-Emergency-Info Header</b>	Enables / disables the use of P-Emergency-Info header in SIP request. When disabled, the SIP message sent from the phone will not include the selected header. Default setting is “Yes”.



<b>Use MAC Header</b>	<ul style="list-style-type: none"> <li>• If <b>Yes for REGISTER only</b>, the sip message for register or unregister will contains MAC address in the header, and all the outgoing SIP messages except REGISTER message will attach the MAC address to the User-Agent header;</li> <li>• If <b>Yes to all SIP</b>, the sip message for register or unregister will contains MAC address in the header, and all the outgoing SIP message including REGISTER will attach the MAC address to the User-Agent header;</li> <li>• If <b>No</b>, neither will the MAC header be included in the register or unregister message nor the MAC address be attached to the User-Agent header for any outgoing SIP message.</li> </ul> <p>The default setting is “No”.</p>
<b>Add MAC in User-Agent</b>	<p>The users can choose to add the MAC address in the User-Agent header.</p> <ul style="list-style-type: none"> <li>• If set to “No” (<b>Default</b>), the phone won’t attach the MAC address to the User-Agent header for any outgoing SIP messages.</li> <li>• If set to “Yes except REGISTER”, the SIP messages for register or unregister will not contain the MAC address in the User-Agent header and all the other outgoing SIP messages will attach the MAC address to the User-Agent header.</li> <li>• If set to “Yes to all SIP”, all the outgoing SIP messages will attach the MAC address to the User-Agent header.</li> </ul>
<b>Account x → SIP Settings → Advanced Features</b>	
<b>Line-Seize Timeout</b>	<p>For Shared Call Appearance, phone must send a SUBSCRIBE-request for the line-seize event package whenever a user attempt to take the shared line off hook. “Line Seize Timeout” is the line-seize event expiration timer. The default value is 15 seconds. The valid range is from 15 to 60.</p>
<b>Presence Eventlist URI</b>	<p>Configures Presence Eventlist URI to monitor the extensions on Multi-Purpose Keys.</p> <p>If the server supports this feature, users need to configure a Presence Eventlist URI on the service side first (i.e., presence@myserver.com) with a list of extensions included. On the phone, in this “Presence Eventlist URI” field, fill in the URI without the domain (i.e., presence). To monitor the extensions in the list, under Web GUI→<b>Settings</b>→<b>Programmable Keys</b> page, please select “Presence Watcher” in the key mode, choose account, enter the value of each extension in the list.</p>
<b>Eventlist BLF URI</b>	<p>Configures the Eventlist BLF URI on the phone to monitor the extensions in the list with Multi-Purpose Key. If the server supports this feature, users need to configure an Eventlist BLF URI on the service side first (i.e., BLF1006@myserver.com) with a list of extensions included. On the phone, in this “Eventlist BLF URI” field, fill in the URI without the domain (i.e., BLF1006). To monitor the extensions in the list, under Web GUI→<b>Settings</b>→<b>Programmable Keys</b> page, please select “Eventlist BLF”</p>



	in the key mode, choose account, enter the value of each extension in the list.
<b>Auto Provision Eventlist BLFs</b>	<p>When option is enabled, empty multi-purpose keys will be automatically provisioned to the monitored extensions in the “Eventlist BLF” or “Presence Eventlist”.</p> <ul style="list-style-type: none"> <li>• <b>Disabled</b></li> <li>• <b>BLF Eventlist</b></li> <li>• <b>Presence Eventlist</b></li> </ul> <p>The default setting is “Disabled”.</p>
<b>Conference URI</b>	Configures Conference URI for N-way conference (Broadsoft Standard).
<b>Music On Hold URI</b>	Configures Music On Hold URI to call when a call is on hold. This feature must be supported on the server side.
<b>BLF Call-pickup</b>	<p>Configures BLF Call-pickup method:</p> <ul style="list-style-type: none"> <li>• <b>Auto:</b> The phone will do either Prefix or barge in code for BLF pickup depend on which on is set.</li> <li>• <b>Force BLF Call-pickup by prefix:</b> The phone will only use Prefix as BLF pickup method.</li> <li>• <b>Disabled:</b> The phone will ignore both BLF pickup method, now the monitored VPK will only dial the extension if pressed.</li> </ul> <p>The default setting is “Auto”.</p>
<b>BLF Call-pickup Prefix</b>	Configures the prefix prepended to the BLF extension when the phone picks up a call with BLF key. The default setting is **.
<b>Call Pickup Barge-In Code</b>	Set feature access code of Call Pickup with Barge-In feature.
<b>PUBLISH for Presence</b>	Enables presence feature on the phone. The default setting is “Disabled”.
<b>Omit charset=UTF-8 in MESSAGE</b>	<p>Omit charset=UTF-8 in MESSAGE content-type.</p> <p>The default setting is “Disabled”.</p>
<b>Allow Unsolicited REFER</b>	<p>Allow Unsolicited REFER to accomplish an outgoing call.</p> <ul style="list-style-type: none"> <li>• <b>Disabled</b></li> <li>• <b>Enabled</b></li> <li>• <b>Enabled/Force Auth</b></li> </ul> <p>The default setting is “Disabled”.</p>
<b>Special Feature</b>	<p>Different soft switch vendors have special requirements. Therefore, users may need select special features to meet these requirements. Users can choose from Standard, Nortel MCS, Broadsoft, CBCOM, RNK, Sylanro, Huawei IMS, PhonePower and UCM Call center depending on the server</p>



	type. The default setting is “Standard”.
<b>Broadsoft</b>	
<b>Broadsoft Call Center</b>	When set to “Yes”, a Softkey “BSCCenter” is displayed on LCD. User can access different Broadsoft Call Center agent features via this Softkey. Please note that “Feature Key Synchronization” will be enabled regardless of this setting. Default setting is “Disabled”. <b>Note:</b> To activate this feature, users need to change the special feature to Broadsoft and setup the Broadsoft Call Center to take effect.
<b>Hoteling Event</b>	Broadsoft Hoteling event feature. Default setting is “Disabled”. With “Hoteling Event” enabled, user can access the Hoteling feature option by pressing the “BSCCenter” softkey.
<b>Call Center Status</b>	When set to “Yes”, the phone will send SUBSCRIBE to the server to obtain call center status. The default setting is “Disabled”.
<b>Broadsoft Executive Assistant</b>	When enabled, Feature Key Synchronization will be enabled regardless of web settings.
<b>Feature Key Synchronization</b>	This feature is used for Broadsoft call feature synchronization. When it’s enabled, DND, Call Forward features and Call Center Agent status can be synchronized between Broadsoft server and phone. Default is “Disabled”.
<b>Broadsoft Call Park</b>	When enabled, it will send SUBSCRIBE to Broadsoft server to obtain Call Park notifications. The default setting is “Disabled”.
<b>VQ RTCP-XR</b>	
<b>VQ RTCP-XR Collector Name</b>	Configures the host name of the central report collector that accepts voice quality reports contained in SIP PUBLISH messages.
<b>VQ RTCP-XR Collector Address</b>	Configures the IP address of the central report collector that accepts voice quality reports contained in SIP PUBLISH messages.
<b>VQ RTCP-XR Collector Port</b>	Configure the port of the central report collector that accepts voice quality reports contained in SIP PUBLISH messages. Default is “5060”.
<b>Account x → SIP Settings → Session Timer</b>	
<b>Enable Session Timer</b>	This option is used to enable or disable session timer on the phone side when server side can provide both session timer UPDATE or session audit UPDATE. The default setting is “No”.
<b>Session Expiration</b>	The SIP Session Timer extension (in seconds) that enables SIP sessions to be periodically “refreshed” via a SIP request (UPDATE, or re-INVITE). If there is no refresh via an UPDATE or re-INVITE message, the session will be terminated once the session interval expires. Session Expiration is the time (in seconds) where the session is considered timed out, provided no successful session refresh transaction occurs beforehand. The default setting is 180. The valid range is from 90 to 64800.



<b>Min-SE</b>	The minimum session expiration (in seconds). The default value is 90 seconds. The valid range is from 90 to 64800.
<b>Caller Request Timer</b>	If set to “Yes” and the remote party supports session timers, the phone will use a session timer when it makes outbound calls. The default setting is “No”.
<b>Callee Request Timer</b>	If set to “Yes” and the remote party supports session timers, the phone will use a session timer when it receives inbound calls. Default setting is “No”.
<b>Force Timer</b>	If Force Timer is set to “Yes”, the phone will use the session timer even if the remote party does not support this feature. If Force Timer is set to “No”, the phone will enable the session timer only when the remote party supports this feature. To turn off the session timer, select “No”. The default setting is “No”.
<b>UAC Specify Refresher</b>	As a Caller, select UAC to use the phone as the refresher; or select UAS to use the Callee or proxy server as the refresher. The default setting is “UAC”.
<b>UAS Specify Refresher</b>	As a Callee, select UAC to use caller or proxy server as the refresher; or select UAS to use the phone as the refresher. The default setting is “UAC”.
<b>Force INVITE</b>	The Session Timer can be refreshed using the INVITE method or the UPDATE method. Select “Yes” to use the INVITE method to refresh the session timer. The default setting is “No”.

#### Account x → SIP Settings → Security Settings

<b>Check Domain Certificates</b>	Choose whether the domain certificates will be checked or not when TLS/TCP is used for SIP Transport. The default setting is “No”.
<b>Validate Certificate Chain</b>	Validate certification chain when TCP/TLS is configured. Default setting is “No”.
<b>Validate Incoming Messages</b>	Choose whether the incoming messages will be validated or not. The default setting is “No”.
<b>Check SIP User ID for Incoming INVITE</b>	If set to “Yes”, SIP User ID will be checked in the Request URI of the incoming INVITE. If it doesn’t match the phone’s SIP User ID, the call will be rejected. The default setting is “No”.
<b>Accept Incoming SIP from Proxy Only</b>	When set to “Yes”, the SIP address of the Request URL in the incoming SIP message will be checked. If it doesn’t match the SIP server address of the account, the call will be rejected. The default setting is “No”.
<b>Authenticate Incoming INVITE</b>	If set to “Yes”, the phone will challenge the incoming INVITE for authentication with SIP 401 Unauthorized response. Default setting is “No”.

#### Account x → Audio Settings

<b>Preferred Vocoder (Choice 1 – 8)</b>	Multiple vocoder types are supported on the phone, the vocoders in the list is a higher preference. Users can configure vocoders in a preference list that is included with the same preference order in SDP message.
<b>Use First Matching Vocoder in 200OK SDP</b>	When it is set to “Yes”, the device will use the first matching vocoder in the received 200OK SDP as the codec. The default setting is “No”.





<b>Codec Negotiation Priority</b>	Configures the phone to use which codec sequence to negotiate as the callee. When set to “Caller”, the phone negotiates by SDP codec sequence from received SIP Invite. When set to “Callee”, the phone negotiates by audio codec sequence on the phone. The default setting is “Callee”.
<b>Hide Vocoder</b>	When option Hide Vocoder is set as Yes, the coded will be hidden from call screen as bellow. The default setting is “No”.
<b>Disable Multiple m line in SDP</b>	When it is set to “No”, the device will reply with multiple m lines; Otherwise, it will reply 1 m line. The default setting is “No”.
<b>SRTP Mode</b>	Enable SRTP mode based on your selection from the drop-down menu. <ul style="list-style-type: none"> <li>• <b>No</b></li> <li>• <b>Enabled But Not forced</b></li> <li>• <b>Enabled and Forced</b></li> <li>• <b>Optional</b></li> </ul> The default setting is “No”.
<b>SRTP Key Length</b>	Allows users to specify the length of the SRTP calls. Available options are: <ul style="list-style-type: none"> <li>• <b>AES 128&amp;256 bit</b></li> <li>• <b>AES 128 bit</b></li> <li>• <b>AES 256 bit</b></li> </ul> Default setting is: AES 128&256 bit
<b>Crypto Life Time</b>	Enable or disable the crypto life time when using SRTP. If users set to disable this option, phone does not add the crypto life time to SRTP header. The default setting is “Yes”.
<b>Symmetric RTP</b>	Defines whether symmetric RTP is supported or not. Default setting is “No”.
<b>Silence Suppression</b>	Controls the silence suppression/VAD feature of the audio codecs except forG.723 (pending) and G.729. If set to “Yes”, a small quantity of RTP packets containing comfort noise will be sent during the periods of silence. If set to “No”, this feature is disabled. Default setting is “No”
<b>Jitter Buffer Type</b>	Selects either Fixed or Adaptive for jitter buffer type, based on network conditions. The default setting is “Adaptive”.
<b>Jitter Buffer Length</b>	Selects jitter buffer length from 100ms to 800ms, based on network conditions. The default setting is “300ms”.
<b>Voice Frames Per TX</b>	Configures the number of voice frames transmitted per packet. When configuring this, it should be noted that the “ptime” value for the SDP will change with different configurations here. This value is related to the codec used and the actual frames transmitted during the in-payload call. For end users, it is recommended to use the default setting, as incorrect settings may influence the audio quality. The default setting is 2.



<b>G723 Rate</b>	This option determines the encoding rate for G723 codec. Users can choose from 6.3kbps encoding rate and 5.3kbps encoding rate. The default setting is “5.3kbps encoding rate”.
<b>G.726-32 Packing Mode</b>	Selects “ITU” or “IETF” for G726-32 packing mode. The default setting is “ITU”.
<b>iLBC Frame Size</b>	This option determines the iLBC packet frame size. Users can choose from 20ms and 30ms. The default setting is “30ms”.
<b>iLBC Payload Type</b>	This option is used to specify iLBC payload type. Valid range is 96 to 127. The default setting is “97”.
<b>OPUS Payload Type</b>	Specifies OPUS payload type. Valid range is 96 to 127. Cannot be the same as iLBC or DTMF Payload Type. Default value is 123.
<b>DTMF Payload Type</b>	Configures the payload type for DTMF using RFC2833. Cannot be the same as iLBC or OPUS payload type.
<b>Send DTMF</b>	This parameter specifies the mechanism to transmit DTMF digits. There are 3 supported modes: <ul style="list-style-type: none"> <li>• <b>In audio:</b> DTMF is combined in the audio signal (not very reliable with low-bit-rate codecs);</li> <li>• <b>RFC2833</b> sends DTMF with RTP packet. Users can check the RTP packet to see the DTMFs sent as well as the number pressed.</li> <li>• <b>SIP INFO</b> uses SIP INFO to carry DTMF.</li> </ul> Default setting is “RFC2833”.
<b>DTMF Delay</b>	Configures the delay between sending DTMF during MPK/VPK use (in milliseconds). Default is “250” ms.
<b>Account x → Call Settings</b>	
<b>Early Dial</b>	Selects whether to enable early dial. If it’s set to “Yes”, the SIP proxy must support 484 responses. Early Dial means that the phone sends for each pressed digit a SIP INVITE message to SIP server. SIP server considers its extensions and, if no match happened yet, it sends back a “484 Address Incomplete” message. Otherwise, it executes the action. The default setting is “No”.
<b>Dial Plan Prefix</b>	Configures the prefix to be added to each dialed number.
<b>Dial Plan</b>	A dial plan establishes the expected number and pattern of digits for a telephone number. This parameter configures the allowed dial plan for the phone. Default setting is “{ x+   \+x+   *x+   *xx*x+ }”. Dial Plan Rules: <ol style="list-style-type: none"> <li>1. Accepted Digits: 1,2,3,4,5,6,7,8,9,0 , * , # , A,a,B,b,C,c,D,d;</li> <li>2. Grammar: <ul style="list-style-type: none"> <li>x – any digit from 0-9</li> <li>X – digits from 0-9, and letters from a-z, A-Z.</li> </ul> </li> </ol>



- a) **xx+** - at least 2-digit numbers
- b) **xx** — only 2-digit numbers
- c) **^** — exclude
- d) **[3-5]** — any digit of 3, 4, or 5
- e) **[147]** — any digit of 1, 4, or 7
- f) **<2=011>** - replace digit 2 with 011 when dialing
- g) **|** — the OR operand
- h) **,** - second dial tone. For example: {0,x+} will play second dial tone after dialing 0 and all digits will be sent including 0
- i) **{X123}** — match Z123, e123, 5123, ...
- j) Flag **T** when adding a “T” at the end of the dial plan, the phone will wait for 3 seconds before dialing out. This gives users more flexibility on their dial plan setup. E.g. with dial plan 1XXT, phone will wait for 3 seconds to let user dial more than just 3 digits if needed. Originally the phone will dial out immediately after dialing the third digit.
- k) Back slash “\” — can be used to escape specific letters. E.g. if { \p\l\r\k\+60 } dial plan is configured, park+60 should be able to pass dial plan check. This also can be used to escape Mark and User-unreserved characters.

Mark = “-” / “\_” / “.” / “!” / “~” / “\*” / “” / “(” / “)”

User-unreserved = “&” / “=” / “+” / “\$” / “,” / “;” / “?” / “/”

- Example 1: {[369]11 | 1617xxxxxxx}

Allow 311, 611, and 911 or any 10 digit numbers with leading digits 1617;

- Example 2: {^1900x+ | <=1617>xxxxxxx}

Block any number of leading digits 1900 or add prefix 1617 for any dialed 7 digit numbers;

- Example 3: {1xxx[2-9]xxxxxx | <2=011>x+}

Allows any number with leading digit 1 followed by a 3-digit number, followed by any number between 2 and 9, followed by any 7-digit number OR Allows any length of numbers with leading digit 2, replacing the 2 with 011 when dialed.

- Example 4: If we set the dial plan with {\\*123}, it should allow input \*123 to pass dial plan check.
- Example 5: If we set the dial plan with {\\$123}, it should allow input \$123 to pass dial plan check.
- Example 6: If we set the dial plan with {12\\_3}, it should allow input 12\_3 to pass dial plan check.

Example of a simple dial plan used in a Home/Office in the US:

{ ^1900x. | <=1617>[2-9]xxxxxx | 1[2-9]xx[2-9]xxxxxx | 011[2-9]x. | [3469]11 }



	<p>Explanation of example rule (reading from left to right):</p> <ul style="list-style-type: none"> <li>• ^1900x. — prevents dialing any number started with 1900;</li> <li>• &lt;=1617&gt;[2-9]xxxxxx — allows dialing to local area code (617) numbers by dialing 7 numbers and 1617 area code will be added automatically;</li> <li>• 1[2-9]xx[2-9]xxxxxx  - allows dialing to any US/Canada Number with 11 digits length.</li> <li>• 011[2-9]x — allows international calls starting with 011;</li> <li>• [3469]11 — allows dialing special and emergency numbers 311, 411, 611 and 911.</li> </ul> <p><b>Note:</b> In some cases, where the user wishes to dial strings such as *123 to activate voice mail or other applications provided by their service provider, the * should be predefined inside the dial plan feature.</p> <p>An example dial plan will be: {*x+} which allows the user to dial * followed by any length of numbers.</p>
<b>Bypass Dial Plan</b>	<p>Enable/Disable the dial plan bypass while dialing through:</p> <ul style="list-style-type: none"> <li>• <b>Contact</b></li> <li>• <b>Call History Incoming Call</b></li> <li>• <b>Call History Outgoing Call</b></li> <li>• <b>Dialing Page</b></li> <li>• <b>MPK</b></li> <li>• <b>API</b></li> </ul> <p>The default setting is “MPK”.</p>
<b>Call Log</b>	<p>Configures Call Log setting on the phone.</p> <ul style="list-style-type: none"> <li>• <b>Log All Calls</b></li> <li>• <b>Log incoming/Outgoing Only (missed calls NOT recorded)</b></li> <li>• <b>Disable Call Log</b></li> </ul> <p>The default setting is “Log All Calls”.</p>
<b>Send Anonymous</b>	<p>If set to “Yes”, the “From” header in outgoing INVITE messages will be set to anonymous, blocking the Caller ID to be displayed. Default is “No”.</p>
<b>Anonymous Call Rejection</b>	<p>If set to “Yes”, anonymous calls will be rejected. The default setting is “No”.</p>
<b>Auto Answer</b>	<p>If set to “Yes”, the phone will automatically turn on the speaker phone to answer incoming calls after a short reminding beep. Default setting is “No”.</p>
<b>Refer-To Use Target Contact</b>	<p>If set to “Yes”, the “Refer-To” header uses the transferred target’s Contact header information for attended transfer. The default setting is “No”.</p>
<b>Transfer on Conference Hang-up</b>	<p>If set to “Yes”, when the phone hangs up as the conference initiator, the conference call will be transferred to the other parties so that other parties will remain in the conference call. The default setting is “No”.</p>



<b>Disable Recovery on Blind Transfer</b>	<p>Disables recovery to the call to the transferee on failing blind transfer to the target. The default setting is “No”.</p> <p><b>Notes:</b></p> <ol style="list-style-type: none"> <li>1) This feature only applies to blind transfer;</li> <li>2) This feature depends on how server handles transfer. If there is any NOTIFY from server, this feature won't take effect. If server responds 4xx, phone should try to recover regardless of this option.</li> <li>3) During blind transfer, after transferor received 200/202 for REFER, but there is no NOTIFY from server after 7 seconds, transferor will decide to recover the call with transferee or not depending on the options. This is the only case that this option will be applied.</li> </ol>
<b>Blind Transfer Wait Timeout</b>	<p>Defines the timeout (in seconds) for waiting SIP frag response in blind transfer. Valid range is 30 to 300. Default setting is “30”.</p>
<b>No Key Entry Timeout</b>	<p>Defines the timeout (in seconds) for no key entry. If no key is pressed after the timeout, the digits will be sent out. The default value is 4 seconds. The valid range is from 1 to 15.</p>
<b>Key As Send</b>	<p>Allows users to configure either the “*” or “#” keys as the “Send” key. Please make sure the dial plan is properly configured to allow dialing * and # out. The default setting is “Pound (#)”.</p>
<b>On Hold Reminder Tone</b>	<p>If set to “Enabled”, phone will play a reminder tone when it has a call on hold. The default setting is “Enabled”.</p>
<b>RFC2543 Hold</b>	<p>Allows users to toggle between RFC2543 hold and RFC3261 hold. RFC2543 hold (0.0.0.0) allows user to disable the hold music sent to the other side. RFC3261 (a line) will play the hold music to the other side. The default setting is “No”.</p>
<b>Hide Dialing Password</b>	<p>Allows users to hide the password when the dialing number matches the configured prefix.</p>
<b>Disable Call Waiting</b>	<p>Enables / disables the call waiting feature for the current account. When set to “Default”, global call feature setting will be used. Default value is “Default”.</p>
<b>Ringtone</b>	
<b>Account Ring Tone</b>	<p>Allows users to configure the ringtone for the account. Users can choose from different ringtones from the dropdown menu.</p> <p><b>Note:</b> User can also choose silent ring tone.</p>
<b>Match Incoming Caller ID</b>	<p>Specifies matching rules with number, pattern or Alert Info text (up to 10 matching rules). When the incoming caller ID or Alert Info matches the rule, the phone will ring with selected distinctive ringtone. Matching rules:</p> <ul style="list-style-type: none"> <li>• <u>Specific caller ID number</u>. For example, 8321123;</li> <li>• <u>A defined pattern</u> with certain length using <b>x</b> and <b>+</b> to specify, where <b>x</b> could be any digit from 0 to 9. Samples:</li> </ul>



	<p><b>xx+</b> : at least 2-digit number;</p> <p><b>xx</b> : only 2-digit number;</p> <p><b>[345]xx</b>: 3-digit number with the leading digit of 3, 4 or 5;</p> <p><b>[6-9]xx</b>: 3-digit number with the leading digit from 6 to 9.</p> <ul style="list-style-type: none"> <li>• <u>Alert Info text</u> Users could configure the matching rule as certain text (e.g., priority) and select the custom ring tone mapped to it. The custom ring tone will be used if the phone receives SIP INVITE with Alert-Info header in the following format: <i>Alert-Info: &lt;http://127.0.0.1&gt;; info=priority</i></li> </ul> <p>Selects the distinctive ring tone for the matching rule. When the incoming caller ID or Alert Info matches one of the 10 rules, the phone will ring with the associated ringtone.</p>
<b>Ring Timeout</b>	Defines the timeout (in seconds) for the rings on no answer. The default setting is 60. The valid range is from 10 to 300.

### Account x → Intercom Settings

<b>Allow Auto Answer by Call-Info/Alert-Info</b>	Allows the phone to automatically turn on the speaker phone to answer incoming calls after a short reminding beep when enabled, based on the SIP Call-Info/Alert-Info header sent from the server/proxy. Default is “Yes”.
<b>Allow Barging by Call-Info/Alert-Info</b>	When enabled, the phone will automatically put the current call on hold and answer the incoming call based on the SIP Call-Info/Alert-Info header sent from the server/proxy. However, if the current call was answered based on the SIP Call-Info/Alert-Info header, then all other incoming calls with SIP Call-Info/Alert-Info headers will be rejected automatically. Default setting is “No”.
<b>Mute on answer Intercom call</b>	When enabled, the phone will mute the incoming intercom call. The default value is “No”.
<b>Play warning tone for Auto Answer Intercom</b>	When enabled, the phone will play warning tone when auto answer Intercom. The default value is “Yes”.
<b>Custom Alert-Info for Auto Answer</b>	Allows to customize Alert-Info header for auto answer. The phone will auto answer only if matching content of the custom Alert-info header.

### Account x → Feature Codes

<b>Enable Local Call Features</b>	<p>When enabled, Do Not Disturb, Call Forwarding and other call features can be used via the local feature codes on the phone. Otherwise, the provisioned feature codes from the server will be used. User configured feature codes will be used only if server provisioned feature codes are not provided. And once feature codes are configured, either via server provisioning or local setting, a Softkey named “Features” will show on the LCD screen.</p> <p><b>Note</b> : If the device is registered with Broadsoft account, it doesn’t matter if local call features are enabled or disabled, once the Broadsoft account is set, special feature to Broadsoft and Feature Key Synchronization is enabled, the</p>
-----------------------------------	--



	call feature will be handled by Broadsoft server, not by the phone.
<b>Do Not Disturb (DND)—On</b>	Configures DND feature code to turn on DND.
<b>Do Not Disturb (DND)—Off</b>	Configures DND feature code to turn off DND.
<b>Call Forward Unconditionally (All)—On</b>	Configures Call Forward All feature code to activate unconditional call forwarding.
<b>Call Forward Unconditionally (All)—Off</b>	Configures Call Forward All feature code to deactivate unconditional call forwarding.
<b>Target</b>	Configures the extension that the call will be forwarded to.
<b>Call Forward Busy—On</b>	Configures Call Forward Busy feature code to activate busy call forwarding.
<b>Call Forward Busy—Off</b>	Configures Call Forward Busy feature code to deactivate busy call forwarding.
<b>Target</b>	Configures the extension that the call will be forwarded to.
<b>Call Forward Delayed (No Answer)—On</b>	Configures Call Forward Delayed feature code to activate no answer call forwarding.
<b>Call Forward Delayed (No Answer)—Off</b>	Configures Call Forward Delayed feature code to deactivate no answer call forwarding.
<b>Target</b>	Configures the extension that the call will be forwarded to.
<b>Delayed Call Forward Wait Time</b>	Defines the timeout (in seconds) before the call is forwarded on no answer. The default value is 20 seconds. The valid range is 1 to 120.

### Accounts → Account Swap

<b>Swap Account Settings</b>	Allows users to swap the two accounts that they have configured. This will increase the flexibility of account management. <b>Note:</b> Make sure to press “Start” to complete the process.
------------------------------	--

## Settings Page Definitions

Table 11: Settings Page Definitions

### Settings → General Settings

<b>Local RTP Port</b>	This parameter defines the local RTP port used to listen and transmit. It is the base RTP port for channel 0. When configured, channel 0 will use this port _value for RTP; channel 1 will use port_value+2 for RTP. Local RTP port ranges from 1024 to 65400 and must be even. Default value is 5004.
-----------------------	--



<b>Local RTP Port Range</b>	Gives users the ability to define the parameter of the local RTP port used to listen and transmit. This parameter defines the local RTP port from 48 to 10000. This range will be adjusted if local RTP port + local RTP port range is greater than 65486. Default setting is 200.
<b>Use Random Port</b>	When set to “Yes”, this parameter will force random generation of both the local SIP and RTP ports. This is usually necessary when multiple phones are behind the same full cone NAT. The default setting is “Yes”  <b>Note:</b> This parameter must be set to “No” for Direct IP Calling to work.
<b>Keep-alive Interval</b>	Specifies how often the phone sends a blank UDP packet to the SIP server to keep the “ping hole” on the NAT router to open. The default setting is 20 seconds. The valid range is from 10 to 160.
<b>Use NAT IP</b>	The NAT IP address used in SIP/SDP messages. This field is blank at the default settings. It should ONLY be used if it’s required by your ITSP.
<b>STUN Server</b>	The IP address or Domain name of the STUN server. STUN resolution results are displayed in the STATUS page of the Web GUI. Only non-symmetric NAT routers work with STUN.
<b>Delay Registration</b>	Configures specific time that the account will be registered after booting up.
<b>Test Password Strength</b>	Only allow password with these constraints to ensure better security: The password has to be more than 9 characters/digits and has to fulfill at least 3 options among 4 options below: 1) Numeric (0-9) 2) Capital letters (A-Z) 3) Lower case (a-z) 4) Special characters (!, @, #, \$, %, ^, &, *, (, ), etc) Default setting is “No”.
<b>Public Mode</b>	
<b>Enable Public Mode</b>	Configures to turn on/off the public mode for hot desking feature. The default setting is “Disabled”.
<b>Enable Fix for RTP Timestamp Jump</b>	Makes RTP timestamps be continuous, if there is audio loss caused by timestamp jump. Default is “No”
<b>Public Mode Username Prefix</b>	Used as prefix of public mode login, when public mode is enabled
<b>Public Mode Username Suffix</b>	Used as suffix of user name in public mode login, when public mode is enabled.
<b>Enable Remote Synchronization</b>	Enables phone to automatically download current account’s setting from remote server and upload to the server. Default setting is “Disabled”.
<b>Server Type</b>	Allows users to choose the type of the server (TFTP, FTP or HTTP) that stores personal files of public account. Default is “TFTP”
<b>Server Path</b>	Defines server path that stores personal files of public account.





<b>FTP/HTTP User Name</b>	Specifies User Name to access FTP/HTTP server.
<b>FTP/HTTP Password</b>	Specifies Password to access FTP/HTTP server.
<b>Outbound Notification</b>	
<b>Enable Outbound Notification</b>	Indicates whether Outbound Notification feature is enabled. Default is "Enabled". For more details refer to [OUTBOUND NOTIFICATION SUPPORT].
<b>Settings → Broadsoft → Broadsoft XSI</b>	
<b>XSI</b>	<p>Configures XSI Directory.</p> <ul style="list-style-type: none"> <li> <b>Server</b>            Configure the BroadWorks Xsi server URI. If the server uses HTTPS, please add the header "HTTPS" ahead of the Server URI. For instance, "https://SERVER_URI".         </li> <li> <b>Port</b>            Configure the BroadWorks Xsi server port. The default port is 80. If the server uses HTTPS, please configure 443.         </li> <li> <b>XSI Actions Path</b>            This feature allows users to configure the deployment path for Broadsoft XSI Actions. If it is empty, the path "com.broadsoft.xsi-actions" will be used.         </li> <li> <b>Broadsoft Contact Download Interval</b>            Configures the Broadsoft phonebook download interval (in minutes). If set to 0, automatic download will be disabled. Valid range is 5 to 4320. Default value is 360.         </li> <li> <b>XSI Authentication Type:</b> <ul style="list-style-type: none"> <li>○ Login Credentials</li> <li>○ SIP Credentials</li> <li>○ Account 1/2/3/4/5/6</li> </ul>           Select XSI Authentication Type. SIP User ID need to be configured if SIP account is selected.         </li> <li> <b>Login Credentials</b> <ul style="list-style-type: none"> <li>○ Login Username. Configure the Username for the BroadWorks XSI server.</li> <li>○ Login Password. Configure the password for the BroadWorks XSI server.</li> </ul> </li> <li> <b>SIP Credentials</b> </li> </ul>



	<ul style="list-style-type: none"><li>○ SIP User Name. Configure SIP Username for the BroadWorks XSI server.</li><li>○ SIP User ID. Configure SIP User ID for the BroadWorks XSI server.</li><li>○ SIP Password Configure SIP Password for the BroadWorks XSI server.</li></ul> <ul style="list-style-type: none"><li>● <b>Sort Phonebook by</b> Select to sort phonebook entries by “Last Name” or “First Name”. The default setting is “Last Name”.</li></ul>
<b>Network Directories</b>	<p>Enable/Disable Broadsoft Network directories and defines the directory name.</p> <p>The directory types are:</p> <ul style="list-style-type: none"><li>● <b>Group Directory</b> Enable/Disable and rename the BroadWorks Xsi Group Directory features on the phone. If keep the Name box blank, the phone will use the default name “Group” for it.</li><li>● <b>Enterprise Directory</b> Enable/Disable and rename the BroadWorks XSI Enterprise Directory features on the phone. If keep the Name box blank, the phone will use the default name “Enterprise” for it.</li><li>● <b>Group Common</b> Enable/Disable and rename the BroadWorks XSI Group Common Directory features on the phone. If keep the Name box blank, the phone will use the default name “Group Common” for it.</li><li>● <b>Enterprise Common</b> Enable/Disable and rename the BroadWorks XSI Enterprise Common Directory features on the phone. If keep the Name box blank, the phone will use default name “Enterprise Common” for it.</li><li>● <b>Personal Directory</b> Enable/Disable and rename the BroadWorks XSI Personal Directory features on the phone. If keep the Name box blank, the phone will use the default name “Personal” for it.</li><li>● <b>Missed Call Log</b> Enable/Disable and rename the BroadWorks XSI Missed Call Log features on the phone. If keep the Name box blank, the phone will use the default name “Missed” for it.</li><li>● <b>Placed Call Log</b> Enable/Disable and rename the BroadWorks XSI Placed Call Log</li></ul>



	<p>features on the phone. If keep the Name box blank, the phone will use the default name “Outgoing” for it.</p> <ul style="list-style-type: none"> <li>• <b>Received Call Log</b> Enable/Disable and rename the BroadWorks XSI Placed Call Log features on the phone. If keep the Name box blank, the phone will use the default name “Incoming” for it.</li> </ul>
--	--

### Settings → Broadsoft → Broadsoft IM&P

<b>Login Credentials</b>	<ul style="list-style-type: none"> <li>• <b>Server</b> Broadsoft IM&amp;P server address. Usually not necessary to configure and can already be found in the Broadsoft IM&amp;P username.</li> <li>• <b>Port</b> Port for the Broadsoft IM&amp;P server. Default port is 5222.</li> <li>• <b>Username</b> Broadsoft IM&amp;P username, not the Broadsoft account username.</li> <li>• <b>Password</b> Broadsoft IM&amp;P password, not the Broadsoft account password.</li> </ul>
<b>Broadsoft IM&amp;P</b>	Enables Broadsoft Instant Message and Presence feature. The default setting is “Disabled”.
<b>Associated Broadsoft Account</b>	Specifies the associated account. User could choose each account on the phone.
<b>Auto Login</b>	Choose to whether login to the Broadsoft IM&P account at boot-up. The default setting is “No”.
<b>Display Non XMPP Contacts</b>	Choose whether to display non-xmpp contacts associated with the Broadsoft IM&P user. Non-xmpp contacts will not display a presence or status message. The default setting is “No”.

### Settings → External Service

<b>Order (1 – 10)</b>	Displays the order of the service.
<b>Service Type</b>	<p>Specifies the service’s type. Two options are available:</p> <ul style="list-style-type: none"> <li>• <b>None</b></li> <li>• <b>GDS</b></li> </ul> <p>Default setting is “None”.</p> <p><b>Note:</b> The GRP26XX supports up 10 GDS items. For more details, refer to <a href="#">Connecting GDS3710 with GRP26XX Guide</a></p>
<b>Account</b>	Specifies the account on which the service will be applied.
<b>System Identification</b>	Specifies the name to identify the service.
<b>System Number</b>	Specifies the system number, in case the service type option is set to GDS, the system number is the SIP user ID configured on GDS3710/GDS3705, or the IP address of the GDS3710/GDS3705 itself if it’s using IP call.
<b>Access Password</b>	Determines the access password, in case the service type option is set to



	GDS, the access password is the one configured on “Remote PIN to Open the Door” field on GDS3710/GDS3705 settings.
<b>Settings → Call Features</b>	
<b>Preferred default Account</b>	Selects the preferred default account when offhook/onhook dialing. When selected account is unavailable, system will fall back to use the first available account instead.
<b>Predictive Dialing Feature</b>	Allows users to show/hide predictive dialing feature, when disabled, users will not see any predictive numbers while dialing a number. Default setting is “Enabled”.
<b>Predictive Dialing Source</b>	Searches sequentially then number while dialing based on the selected sources from these: Call History, Local Phonebook, Remote Phonebook, Feature Code. Press “Modify” to edit available options.
<b>Onhook Dial Barging</b>	Allows incoming call to interrupt on-hook dialing when set to “Enabled”. Default setting is “Enabled”.
<b>Off-hook Auto Dial</b>	Configures a User ID/extension to dial automatically when the phone is off hook. The phone will use the first account to dial out. Default setting is “No”.
<b>Off-hook Auto Delay</b>	Configures the number of seconds during which the phone will wait before dialing out when off-hood auto dial number is configured. The default is 4.
<b>Off-hook Timeout</b>	If configured, when the phone is off hook, it will go on hook after the timeout (in seconds). The default value is 30 seconds. Valid range is from 10 to 60.
<b>Enable Live DialPad</b>	Enables to Dial out automatically the number punched in after the number of seconds that the user had set when the phone is off-hook. Default value is “No”
<b>Live DialPad Expire Time</b>	Sets the Live DialPad expire time before initiating the call using Live DialPad feature. Interval is between 2s and 15s. Default value is 5s.
<b>Last Call Forward All</b>	Configures to enable storing the last input number when entering number in the call screen after pressing the ForwardAll softkey. Default is “No”.
<b>Enable Automatic Redial</b>	Enables the phone to redial automatically when called number is busy. If enabled, the phone will prompt the user to start “automatic redial” or no. If yes, the phone will redial called number several times [ <b>Automatic Redial Times</b> ] with [ <b>Automatic Redial Interval</b> ] between each call. The user is guided via different prompts on phone’s LCD displaying number of remaining attempts, count-down to initiate next auto redial and allowing user to manually initiate the call without waiting for the specified interval [ <b>Automatic Redial Interval</b> ]. The phone will stop automatic redial after successful attempt (called party not busy) or after unsuccessful attempts [ <b>Automatic Redial Times</b> ]. The default setting is “No”.
<b>Automatic Redial Times</b>	The number of times to attempt to call using Automatic Redial feature. The valid range is 1 – 200. The default value is “10”.



<b>Automatic Redial Interval</b>	The interval between each call attempt using Automatic Redial feature. The valid range is 1 – 360. The default value is “10”.
<b>Bypass Dial Plan Through Call History and Directories</b>	Enable/Disable the dial plan check while dialing through the call history and any phonebook directories. The default setting is “No”.
<b>Disable Call Waiting</b>	Disables the call waiting feature. The default setting is “No”.
<b>Disable Call Waiting Tone</b>	Disables the call waiting tone when call waiting is on. Default setting is “No”.
<b>Ring For Call Waiting</b>	Disables / enables ringing instead of playing call-waiting tone when audio is on handset or headset. The default setting is “No”.
<b>Disable Busy Tone on Remote Disconnect</b>	Disables the busy tone heard in the handset when call is disconnected remotely. The default setting is “No”.
<b>Disable Direct IP Call</b>	Disables Direct IP Call. The default setting is “No”.
<b>Use Quick IP Call mode</b>	When set to “Yes”, users can dial an IP address under the same LAN/VPN segment by entering the last octet in the IP address. To dial quick IP call, off hook the phone, press # to switch to “Direct IP Call” mode and dial XXX (X is 0-9 and XXX <=255), phone will make direct IP call to aaa.bbb.ccc.XXX where aaa.bbb.ccc comes from the local IP address REGARDLESS of subnet mask. XX or X are also valid so leading 0 is not required (but OK). No SIP server is required to make quick IP call. The default setting is “No”.
<b>Disable Conference</b>	Disables the Conference function. The default setting is “No”.
<b>Disable in-call DTMF Display</b>	Enables/disables the display of entered DTMF digits on the phone LCD during the call. The default setting is “No”.
<b>Enable Sending DTMF via specific MPKs</b>	Allows certain MPKs to send DTMF in-call. This option doesn’t affect Dial DTMF. The default setting is “No”.
<b>Enable Active VPK Page</b>	Enables Active VPK Page to be displayed on LCD when there are active VPKs. The default setting is “No”.
<b>Enable DND Feature</b>	If set to “No”, the user cannot turn on Do Not Disturb feature via MUTE key, MPK, or menu on LCD. The default setting is “Yes”.



<b>Mute Key Functions While Idle</b>	<p>Specifies the function of mute key in idle. Default setting is “DND”.          When select “Idle Mute” and press Mute key while idle, the future incoming call will be answered with mute. When select “Disabled”, Mute key will not take effect while idle.          The default setting is “DND”.</p>
<b>DND Override</b>	<p>Allows the phone to accept certain incoming calls while set to DND mode.</p> <ul style="list-style-type: none"> <li>• <b>Off:</b> all incoming calls will not be accepted.</li> <li>• <b>Allow all:</b> all incoming calls will be allowed.</li> <li>• <b>Allow Only Contacts:</b> only incoming calls from numbers in the local phonebook will be accepted.</li> <li>• <b>Allow Only Favorites:</b> only incoming calls from favorite numbers in the local phonebook will be accepted.</li> </ul> <p>The default setting is “Off”.</p>
<b>Disable Transfer</b>	<p>Enables/disables transfer feature. If disabled, call transfer will not be possible. Default setting is “No”.</p>
<b>In-call Dial Number on Pressing Transfer Key</b>	<p>Configures the number to be dialed as DTMF using TRANSFER button.</p>
<b>Attended Transfer Mode</b>	<p>If set to "Static", attended transfers can only be performed with pre-established calls. If set to "Dynamic", attended transfers can be performed with pre-established calls OR be initiated during the transfer process. This option does not affect the user's ability to perform blind transfers.          The default setting is “Dynamic”.          For more details about “Static” / “Dynamic” transfer, refer to the user guide.</p>
<b>Transfer Mode via VPK</b>	<p>Perform “Blind Transfer”, “Attended Transfer”, or a “New Call” with the specified number in the Value field when a user presses "Transfer" virtual multiple-purpose key. Default is “Blind Transfer”.</p>
<b>Hold Call in Transfer</b>	<p>When set to "No", phone will neither hold the current call in transfer window nor hold the call with the transfer target before referring the call in the attended transfer. The default setting is “Yes”.</p>
<b>Show On Hold Duration</b>	<p>Show the duration of holding a call on the LCD.          The default setting is “Yes”.</p>
<b>Do Not Escape # as %23 in SIP URI</b>	<p>Specifies whether to replace # by %23 or not for some special situations.          The default setting is “No”.</p>
<b>Click-To-Dial Feature</b>	<p>Enables Click-To-Dial feature. If this feature is enabled, user could click the green dial button  on left top corner of phone's Web GUI, then choose</p>



	the account and dial to the target number. The default setting is “Disabled”. For more details refer to [CLICK-TO-DIAL].
<b>Default call log type</b>	Sets the default call log list after select <b>MENU→CALL HISTORY</b> . Broadsoft Call Log or Local Call Log option will only show its own list. Default option will keep both call log lists. The default setting is “Default”.
<b>Return Code When Refusing Incoming Call</b>	When refusing the incoming call. The phone will send the selected type of SIP message of the call. Available options are: <ul style="list-style-type: none"> <li>• <b>Busy (486).</b></li> <li>• <b>Temporarily Unavailable (480).</b></li> <li>• <b>Not found (404).</b></li> <li>• <b>Decline (603).</b></li> </ul> Default setting is “Busy 486”.
<b>Return Code When Enable DND</b>	When DND is enabled, the phone will send the selected type of SIP message. Available options are: <ul style="list-style-type: none"> <li>• <b>Busy (486).</b></li> <li>• <b>Temporarily Unavailable (480).</b></li> <li>• <b>Not found (404).</b></li> <li>• <b>Decline (603).</b></li> </ul> Default setting is “Temporarily Unavailable (480)”.
<b>Enable BLF Pickup Screen</b>	By enabling BLF Pickup Screen, when monitored BLF is ringing, GRP26xx will pop up a BLF information window. The default setting is “No”.
<b>Enable BLF Pickup Sound</b>	Gives the user the ability to set sound notification to the monitoring BLF line when it’s ringing, GRP26xx will play a sound to inform user. The default setting is “No”.
<b>BLF Pickup Sound Except List</b>	Configures the list to be playing BLF sound notification for “All Except” extensions in the list [BLF Pickup Sound Except List] or “Only Allow” extensions in the list [BLF Pickup Sound Only List]. The default setting is “Allow Except”.
<b>BLF Pickup Sound Only list</b>	Configures play BLF sound notification only for the list below.
<b>Local Call Recording Feature</b>	Gives the ability to record calls locally while on the call screen. The default setting is “Disabled”.
<b>Replace the oldest call record</b>	When enabled, the oldest call record will be replaced with the newest one when the storage is full. If the option is disabled, the call recording feature will stop recording automatically. Default is “Disabled”.
<b>Download Local Call Recordings</b>	When there are recordings presented, you may download them here.
<b>Enable IM Popup</b>	If set to “No”, phone will not show a pop up when receiving an IM. The default setting is “Yes”.



<b>Instant Message Popup Timeout</b>	Configures the number of seconds that the message will remain on screen. The valid range is 10 – 900. The default setting is “10”.
<b>Play Tone On Receiving IM</b>	If enabled, phone will play a short tone when receiving an IM during idle state. Default setting is “Disabled”.
<b>Allow Incoming Call Before Ringing</b>	This allows incoming calls after dialed but before ringing. This can be used under custom user configuration based on need. Default setting is “No”.
<b>User-Agent Prefix</b>	Configures the prefix in the User-Agent header.
<b>Auto Provision List Starting Point</b>	Users could select “VPK” or “MPK” which will be used first when the phone is being automatically provisioned with Eventlist BLF. The default setting is “VPK”. This feature is supported only on GRP2614.
<b>Hide BLF Remote Status</b>	Allows users to hide the Caller ID from showing at the BLF VPK and MPK. <ul style="list-style-type: none"> <li>• <b>No:</b> The VPK will flash between the Caller ID and the BLF account.</li> <li>• <b>Yes:</b> The VPK will stay under the monitored account and only notify that there is an incoming call.</li> </ul> The default setting is “No”.
<b>Show SIP Error Response</b>	Shows SIP error response information on LCD screen. The default setting is “Yes”.
<b>Enable Missed Call Notification</b>	Allows users to show/hide the notification popup for missed calls. The default setting is “Yes”. <b>Note:</b> Currently the manually rejected calls are counted as missed calls.
<b>Enable Call Completion Service</b>	When the automatic redial and call completion service are enabled, and the user makes a call to callee, when the callee is busy at the moment, phone will monitor callee’s status. Once the callee is available, phone will ask if user wants to redial again. The default setting is “No”.
<b>Enable Incoming Call Popup</b>	If set to “Yes”, phone will pop up an incoming call window to notify the call. If set to “No”, there will be no notification pop up on LCD when there is an incoming call. This way users will not get disrupted by unexpected popup call but still get notified by the flashing line LED. The default setting is “Yes”.
<b>Enable Enhanced Acoustic Echo Canceller</b>	Enables/Disables Enhanced Acoustic Echo Canceller (EAC) providing acoustic echo reduction which is required for full-duplex handsfree speaker phone functions on the phone. The default setting is “Yes”.
<b>Auto Answer Delay</b>	Configure the delay for automatically answering the incoming call. Valid range is 0 to 10 (second). The default value is 0 (which means auto answer is disabled).

**Settings → Multicast Paging**





<b>Allowed in DND Mode</b>	Allow Multicast Paging when DND mode is enabled. Default Setting is “No”.
<b>Paging Barge</b>	During active call, if incoming multicast page is higher priority (1 being the highest) than this value, the call will be held and multicast page will be played. The default setting is “Disabled”.
<b>Paging Priority Active</b>	If enabled, during a multicast page if another multicast is received with higher priority (1 being the highest) that one will be played instead. The default setting is “Enabled”.
<b>Multicast Paging Codec</b>	The codec for sending multicast pages, there are 5 codecs could be used: PCMU, PCMA, G.726-32, G.729A/B, G.722 (wide band), G.723.1. Default setting is “G.722(wide band)”.
<b>Multicast Channel Number</b>	Multicast Channel Number (0-50). 0 for normal RTP packets, 1-50 for Polycom multicast format packets.
<b>Multicast Sender ID</b>	Outgoing caller ID that displays to your page group recipients (for multicast channel 1 – 50).
<b>Multicast Listening</b>	<p>Defines multicast listening addresses and labels. For example:</p> <ul style="list-style-type: none"> <li>• “Listening Address” should match the sender’s Value such as “237.11.10.11:6767”</li> <li>• “Label” could be the description you want to use.</li> </ul> <p>For details, please check the “Multicast Paging User Guide” on our Website.</p>

### Settings → Outbound Notification

<b>Action URL</b>	<p>For detailed instruction for this part, please refer to [OUTBOUND NOTIFICATION SUPPORT] section in this Administration Guide.</p> <ul style="list-style-type: none"> <li>• Setup Completed</li> <li>• Registered</li> <li>• Unregistered</li> <li>• Register Failed</li> <li>• Off Hook</li> <li>• On Hook</li> <li>• Incoming Call</li> <li>• Outgoing Call</li> <li>• Missed Call</li> <li>• Answered Call</li> <li>• Rejected Call</li> <li>• Forwarded Call</li> <li>• Established Call</li> <li>• Terminated Call</li> <li>• Idle to Busy</li> </ul>
-------------------	--



	<ul style="list-style-type: none"> <li>• Busy to Idle</li> <li>• Open DND</li> <li>• Close DND</li> <li>• Open Forward</li> <li>• Close Forward</li> <li>• Open Unconditional Forward</li> <li>• Close Unconditional Forward</li> <li>• Open Busy Forward</li> <li>• Close Busy Forward</li> <li>• Open No Answer Forward</li> <li>• Close No Answer Forward</li> <li>• Blind Transfer</li> <li>• Attended Transfer</li> <li>• Transfer Finished</li> <li>• Transfer Failed</li> <li>• Hold Call</li> <li>• UnHold Call</li> <li>• Mute Call</li> <li>• IP Change</li> <li>• Auto-Provision Finish</li> </ul>
<b>Destination</b>	Up to 10 destinations can be configured here. For detailed instruction for this part, please refer to [OUTBOUND NOTIFICATION SUPPORT] section in this Administration Guide.
<b>Notification</b>	Specifies the message body of the notification for each event that can be customized with embedded dynamic attributes. For more details, refer to [OUTBOUND NOTIFICATION SUPPORT] section in this Administration Guide.
<b>Settings → Preferences → Audio Control</b>	
<b>Headset</b>	
<b>Headset Key Mode</b>	<p>When headset is connected to the phone, users could use the HEADSET button in “Default Mode” or “Toggle Headset/Speaker”.</p> <p><b>1. Default Mode:</b></p> <ul style="list-style-type: none"> <li>➤ When the phone is in idle, press HEADSET button to off hook the phone and make calls by using headset. Headset icon will display on the screen in dialing/talking status.</li> <li>➤ When there is an incoming call, press HEADSET button to pick up the call using headset.</li> <li>➤ When there is an active call using headset, press HEADSET button to hang up the call.</li> </ul>



	<ul style="list-style-type: none"> <li>➤ When Speaker/Handset is being used in dialing/talking status, press HEADSET button to switch to headset. Press it again to hang up the call. Or press speaker/Handset to switch back to the previous mode.</li> </ul> <p><b>2. Toggle Headset/Speaker:</b></p> <ul style="list-style-type: none"> <li>➤ When the phone is in idle, press HEADSET button to switch to Headset mode. The headset icon will display on the left side of the screen. In this mode, if pressing Speaker button or Line key to off hook the phone, headset will be used.</li> <li>➤ When there is an active call, press HEADSET button to toggle between Headset and Speaker.</li> </ul>
<b>Headset Type</b>	Selects whether the connected headset is normal RJ11 headset, Plantronics EHS headset. Default setting is “Normal”.
<b>EHS Headset Ringtone</b>	Selects normal ringtone or Plantronics EHS ringtone for Plantronics EHS headset. Default is “Normal”.
<b>Always Ring Speaker</b>	<p>Configures to enable or disable the speaker to ring when headset is used on “Toggle Headset/Speaker” mode.</p> <ul style="list-style-type: none"> <li>• If set to “Yes, both”, when the phone is in Headset “Toggle Headset/Speaker” mode, both headset and speaker will ring on incoming call.</li> <li>• If set to “Yes, speaker only”, when the phone is in Headset “Toggle Headset/Speaker” mode, only speaker will ring on incoming call.</li> </ul> <p>The default setting is “No”.</p>
<b>Headset TX gain</b>	Configures the transmission gain of the headset. Available values: -6dB, 0dB or +6dB. The default value is 0dB.
<b>Headset RX gain</b>	Configures the receiving gain of the headset. Available values: -6dB, 0dB or +6dB. The default value is 0dB.
<b>Handset</b>	
<b>Handset TX gain</b>	Configures the transmission gain of the handset. Available values: -6dB, 0dB or +6dB. The default value is 0dB.
<b>Settings → Preferences → Date and Time</b>	
<b>NTP Server</b>	Defines the URL or IP address of the NTP server. The phone may obtain the date and time from the server. The default setting is “pool.ntp.org”.
<b>Secondary NTP Server</b>	Defines the URL or IP address of the NTP server. The phone may obtain the date and time from the server. Allow user to configure 2 NTP server domain names. GRP will loop through all of the IP addresses resolved from them.
<b>NTP Update Interval</b>	Time interval for updating time from the NTP server. Valid time value is in



	<p>between 5 to 1440 minutes. The default setting is “1440” minutes.</p>
<b>Allow DHCP Option 42 Override NTP Server</b>	<p>Defines whether DHCP Option 42 should override NTP server or not. When enabled, DHCP Option 42 will override the NTP server if it’s set up on the LAN. The default setting is “No”.</p>
<b>Time Zone</b>	<p>Configures the date/time used on the phone according to the specified time zone. The default setting is “Auto”.</p>
<b>Allow DHCP Option 2 to Override Time Zone Setting</b>	<p>Allows device to get provisioned for Time Zone from DHCP Option 2 in the local server. The default setting is enabled.</p>
<b>Self-Defined Time Zone</b>	<p>This parameter allows the users to define their own time zone, when “Time Zone” parameter is set to “Self-Defined Time Zone”.</p> <p>The syntax is: <b>std offset dst [offset], start [/time], end [/time]</b> Default is set to: <b>MTZ+6MDT+5,M4.1.0,M11.1.0</b></p> <p><b>MTZ+6MDT+5</b> This indicates a time zone with 6 hours offset with 1 hour ahead (when daylight saving) which is U.S central time. If it is positive (+) if the local time zone is west of the Prime Meridian (A.K.A: International or Greenwich Meridian) and negative (-) if it is east.</p> <p><b>M4.1.0,M11.1.0</b> The 1<sup>st</sup> number indicates Month: 1,2,3.., 12 (for Jan, Feb, .., Dec) The 2<sup>nd</sup> number indicates the nth iteration of the weekday: (1<sup>st</sup> Sunday, 3<sup>rd</sup> Tuesday...) The 3<sup>rd</sup> number indicates weekday: 0,1,2,..,6( for Sun, Mon, Tues, ... ,Sat) Therefore, this example is the DST which starts from the First Sunday of April to the 1<sup>st</sup> Sunday of November.</p>
<b>Date Display Format</b>	<p>Configures the date display format on the LCD. The following formats are supported.</p> <ul style="list-style-type: none"> <li>• <b>yyyy-mm-dd</b>: 2019-03-02</li> <li>• <b>mm-dd-yyyy</b>: 03-02-2019</li> <li>• <b>dd-mm-yyyy</b>: 02-03-2019</li> <li>• <b>dddd, MMMM dd</b>: Saturday, March 02</li> <li>• <b>MMMM dd, dddd</b>: March 02, Saturday</li> </ul> <p>The default setting is yyyy-mm-dd.</p>
<b>Time Display Format</b>	<p>Configures the time display in 12-hour or 24-hour format on the LCD. The default setting is in 12-hour format.</p>
<b>Show Date on Status Bar</b>	<p>Allows users to display time and date on the top panel of the LCD screen. Default setting is “No”.</p>

**Settings → Preferences → Language**



<b>Display Language</b>	Selects display language on the phone. There are 21 languages can be set as display language, user could also choose “Auto” or “Downloaded Language” as display language. The default setting is “Auto”.
<b>Default Input Selection</b>	Configures the default input selection. <ul style="list-style-type: none"> <li>• <b>Multi-Tap:</b> multi-tap to switch character;</li> <li>• <b>Shiftable:</b> select input from available characters.</li> </ul> The default setting is “Multi-Tap”.
<b>Auto language download</b>	This is used to configure the device to download language files automatically from server. The default setting is “No”.
<b>Settings → Preferences → LCD Display</b>	
<b>Backlight Brightness: Active</b>	Configures the LCD brightness when the phone is active. Valid range is 10 to 100 where 100 is the brightest. Default value is “100”.
<b>Backlight Brightness: Idle</b>	Configures the LCD brightness when the phone is idle. Valid range is 0 to 100 where 0 is off and 100 is the brightest. Default value is “60”.
<b>Active Backlight Timeout</b>	Allows user to set up the backlight time (in minutes). Valid range from 0 to 90. Default value is “1”. <b>Note:</b> When Active Backlight Timeout is set to 0, the backlight will be constantly on.
<b>Disable Missed Call Backlight</b>	Disables/enables LCD backlight when there is a missed call notification. <ul style="list-style-type: none"> <li>• If set to “Yes”, the screen will turn off the LCD backlight even if there is a missed call on the phone.</li> <li>• If set to “Yes, but flash MWI LED”, the phone will turn off LCD backlight but MWI will not be deemed when there is a missed call.</li> <li>• If set to “No”, the phone will not turn off LCD backlight when there is a missed call.</li> </ul> The default setting is “No”.
<b>Wallpaper</b>	
<b>Wallpaper Source</b>	Specifies the wallpaper source mode: Default, Download, Uploaded and Color Background. User could upload a wallpaper source into your phone or download it from file server with the server path. <b>Note:</b> If you choose “Color Background”, you need to enter a HEX color code based on your preference. The color codes could be found here: <a href="http://htmlcolorcodes.com/">http://htmlcolorcodes.com/</a> . If an invalid code is configured, the phone will use default value #000000 instead.
<b>Wallpaper Server Path</b>	Specifies the wallpaper server path. This option will take effect when wallpaper source is “Download”.



<b>Upload Wallpaper</b>	Click on the “Upload” button to browse and upload the desired wallpaper file. This option will take effect when wallpaper source is “Uploaded”.
<b>Color Background</b>	Enter a color you wish to use in HEX format. E.g. #000000 Reference: <a href="http://htmlcolorcodes.com">http://htmlcolorcodes.com</a> Please note the user must select “Color Background” in “Wallpaper Source” option in order to use the configurable color background code.
<b>Screensaver</b>	
<b>Screensaver</b>	Configures Screensaver Feature, or “to enable Screensaver feature if no VPK is active”. Please note this option is also available under LCD→ <b>Menu</b> → <b>Preference</b> → <b>Appearance</b> . The phone will consider the page active if VPK is in Early (ringing), Trying (dialing) and Confirmed (talking) status when VPK is configured with mode “BLF”, “Eventlist BLF” or “Presence”. By default, screensaver is set to “On if no VPK is active”.
<b>Screensaver Source</b>	Sets the location where screensaver is loaded from.
<b>Show Date and Time</b>	Allows to see time and date on phone’s screensaver mode. Default setting is “Yes”.
<b>Screensaver Timeout</b>	Configures the minutes of idle before the screensaver activates. Valid range is 3 to 60. The default time is 3 minutes.
<b>Screensaver Server Path</b>	Configures the server path which contains download screensaver definition XML.
<b>Screensaver XML Download Interval</b>	Configures the screensaver XML download interval (in minutes). If set to 0, automatic download will be disabled. Valid range is 5 to 720. The default setting is “0”.
<b>Settings → Preferences → MPK LCD Settings (Available on GRP2614 only)</b>	
<b>MPK LCD Display Order</b>	Selects display mode for MPK LCD. <ul style="list-style-type: none"> <li>• <b>Sequential mode:</b> MPKs will be displayed from left side to right side.</li> <li>• <b>Alternating Mode:</b> MPKs with even ID will be displayed on left side while MPKs with odd ID will be displayed on right.</li> </ul> The default setting is “Sequential”.
<b>Display Contact on MPK LCD</b>	Select whether or not to display contact on MPK LCD. The default setting is “No”.
<b>Wallpaper</b>	
<b>Wallpaper Source for MPK LCD</b>	Specifies the location where wallpapers for MPK LCD are stored. Default or Uploaded. The default setting is “Default”.
<b>Upload Wallpaper for MPK LCD</b>	Upload an image for the MPK LCD wallpaper. <b>Note:</b> Must be in PNG format. 500 KB or smaller.
<b>Settings → Preferences → LED Control</b>	



<b>BLF LED Pattern</b>	Configures the color and pattern of the LED based on status updates. The default setting is “Default”. The BLF LED Patterns are listed in [BLF LED PATTERNS].
<b>Disable VM/MSG power light flash</b>	The VM/MSG light cannot flash even though there’s an unread voice mail or message when set to “Yes”. Default settings is “No”.
<b>BLF LED Pattern Explanation Form</b>	Users could view the color and pattern of the LED status based on the BLF status update.
<b>Settings → Ringtone</b>	
<b>Call Progresses Tones:</b>	Configures ring or tone frequencies based on parameters from local telecom. The default value is North American standard. Frequencies should be configured with known values to avoid uncomfortable high pitch sounds.
<ul style="list-style-type: none"> <li>• System Ring Tone</li> <li>• Dial Tone</li> <li>• Second Dial Tone</li> <li>• Message Waiting</li> <li>• Ring Back Tone</li> <li>• Call-Waiting Tone</li> <li>• Busy Tone</li> <li>• Reorder Tone</li> </ul>	<p><b>Syntax:</b> f1=val,f2=val[,c=on1/off1[-on2/off2[-on3/off3]]]; (Frequencies are in Hz and cadence on and off are in 10ms)</p> <p>ON is the period of ringing (“On time” in ‘ms’) while OFF is the period of silence.</p> <p>In order to set a continuous ring, OFF should be zero. Otherwise it will ring ON ms and a pause of OFF ms and then repeat the pattern. Up to three cadences are supported.</p>
<b>Call Waiting Tone Gain</b>	Configures the call waiting tone gain to adjust call waiting tone volume (Low, Medium or High). The default setting is “Low”.
<b>Speaker Ring Volume</b>	Configures speaker ring volume. The valid range is 0 to 7. The default setting is 5.
<b>Notification Tone Volume</b>	Configures notification tone volume. The valid range is 0 to 7 and default setting is 5.
<b>Lock Speaker Volume</b>	Lock volume adjustment when the option is enabled so it cannot be changed from phone LCD. The option can be set to: “No”, “Ring”, “Talk” or “Both”. Default setting is “No”.
<b>Default Ringtone</b>	Allows to set Default Ringtone as their Global ringtone.  <b>Note:</b> The ring tone set in individual accounts have higher priority to this setting. If the user wants the default ring tone to be used globally, he needs to set the ring tone of each account to Default Ring Tone; Otherwise, it will be whichever the ring tone you set.  <b>Important:</b> The Priority goes as: Contact Ring Tone → Account Ring Tone → Default Ring Tone.
<b>Settings → Programmable Keys → Virtual Multi-Purpose Keys Settings</b>	
<b>Idle Screen Settings</b>	



<b>Show Label Background</b>	If enabled, the VPK label's background will match the status of the VPK and will no longer be transparent. The default setting is "No".
<b>Use Long Label</b>	If enabled, the VPK label will extend as far as possible. The default setting is "Yes".
<b>Call Screen Settings</b>	
<b>Key Mode</b>	If set to "Line Mode", the amount of VPKs will be the amount of lines you can have. If set to "Account Mode", the lines will be grouped by account, so the VPKs could hold more lines in one account. For example, with line mode, when the line is in use, by pressing the VPK, nothing is going to happen. In Account Mode, when the line is in use, by pressing the VPK, a new line will be initiated. The default setting is "Account Mode".
<b>Transfer Mode via VPK</b>	Allows users to configure "Transfer" VPK to do either Blind or Attended Transfer. They can also set their Transfer key to make a new call with the configured number. The default setting is "Blind Transfer".
<b>Enable Transfer via non-Transfer MPK</b>	MPK with type BLF, Speed dial, etc. will perform as transfer MPK under active call. The default setting is "No".
<b>Show Keys Label</b>	<ul style="list-style-type: none"> <li>• If set to "<b>Show</b>", side labels will be shown during calls.</li> <li>• If set to "<b>Hide</b>", side labels will be hidden during calls for more space to display the user information.</li> <li>• If set to "<b>Toggle</b>", a softkey will appear so that users can click to Show/Hide the side labels.</li> </ul> The default setting is "Toggle".
<b>Settings → Programmable Keys → Virtual Multi-Purpose Keys</b>	
<b>Mode</b>	Assigns a function to the corresponding line key. The key mode options are: <ul style="list-style-type: none"> <li>• <b>None</b></li> <li>• <b>Default</b> Regular line key to open up a line and switch line. The Value field can be left blank.</li> <li>• <b>Shared</b> Share line for Shared Line Appearance feature. Select the Account registered as Shared line for the line key. The Value field can be left blank. <b>Note:</b> Users can either show or hide VPK shared line display description, This only can be done with provisioning using the Pvalue P8484 (Value = 0; No . Value = 1; Yes)</li> </ul>





- **Speed Dial**  
Select the Account to dial from. And enter the Speed Dial number in the Value field to be dialed, or enter the IP address to set the Direct IP call as Speed Dial.
- **Busy Lamp Field (BLF)**  
Select the Account to monitor the BLF status. Enter the extension number in the Value field to be monitored.
- **Presence Watcher**  
This option has to be supported by a presence server and it is tied to the “Do Not Disturb” status of the phone’s extension.
- **Eventlist BLF**  
This option is similar to the BLF option but in this case the PBX collects the information from the phones and sends it out in one single notify message. PBX server has to support this feature.
- **Speed Dial via active account**  
Similar to Speed Dial but it will dial based on the current active account. For example, if the phone is offhook and account 2 is active, it will call the configured Speed Dial number using account 2.
- **Dial DTMF**  
Enter a series of DTMF digits in the Value field to be dialed during the call. “Enable MPK Sending DTMF” has to be set to “Yes” first.
- **Voice Mail**  
Select Account and enter Voice Mail access number in the Value field.
- **Call Return**  
The last answered calls can be dialed out by using Call Return. The Value field should be left blank. Also, this option is not binding to the account and the call will be returned based on the account with the last answered call.
- **Transfer**  
Select Account, and enter the number in the Value field to be transferred (blind transfer) during the call.
- **Call Park**  
Select Account, and enter the call park extension in the Value field to park/pick up the call.



- **Monitored Call Park**  
Select account from Account field, and enter the call park extension in the Value field to park/pick up the call, and also monitor the parked call via Line Key's light.
- **Intercom**  
Select Account, and enter the extension number in the Value field to do the intercom.
- **LDAP Search**  
This option is to narrow the LDAP search scope. Enter the LDAP search base in the Description field. It could be the same or different from the Base in LDAP configuration under Advanced Settings. The Base in LDAP configuration will be used if the Description field is left blank. Enter the LDAP Name/Number filter in the Value field.  
For example:  
If users set MPK 1 as "LDAP Search" for "Account 1", and set filters:  
**Description** -> ou=video,ou=SZ,dc=grandstream,dc=com  
**Value** -> sn=Li  
Since the Base for LDAP server configuration is:  
"dc=grandstream,dc=com", "ou=video,ou=SZ" is added to narrow the LDAP search scope. "sn=Li" is the example to filter the last name.
- **Conference**  
Allow user to set their Multi-Purpose Key to "Conference" mode to trigger a conference.  
By setting the extension number in the value box, the users will be able to activate a 3-way conference by simply press the assigned MPK button.
- **Multicast Paging**  
This option is for multicast sending. Enter Line key description in Description field and multicast sending address in Value field.
- **Record**  
This option is for Recording calls. Enter Line key description in Description field and the recorded extension number in Value field. Please make sure whether your VOIP provider supports this feature before using it.
- **Call Log**  
Select Account and enter account number in the Value field to allow



configuration of call log for other extension.

- **Menu**  
Select this feature in order to display the Menu from the MPK buttons, no field dis required for configuration.
- **XML Application**  
Select this feature in order to start the XML Application from the MPK buttons, no field dis required for configuration.
- **Information**  
Select this feature in order to display the Information popup to show the firmware version, MAC address, IP address and IP Settings from the MPK buttons, no field dis required for configuration.
- **Message**  
Select this feature in order to display the Message menu from the MPK buttons, no field dis required for configuration
- **Forward**  
Set the MPK Button to perform call forwarding to the destination number configured on the “Value Field”. During ringing press the button to perform the call forward.
- **DND**  
Press the configured key to enabled/Disable DND.
- **Redial**  
On this mode, the configured key can be used to redial numbers.
- **Instant Messages**  
On this mode, the configured key can be used to enter IM menu and send new messages.
- **Multicast Listen Address**  
The MPK button can be used to access directly to the Multicast listening IP list.
- **Keypad Lock**  
Configure the VPK button to be used to lock/unlock the keypad.
- **GDS DoorOpen**  
Configure the VPK button to be used as GDS DoorOpen. Set PIN code in value field.



	<ul style="list-style-type: none"> <li>• <b>Presence Eventlist</b> This option is similar to the Presence Watcher option but in this case the PBX collects the information from the phones and sends it out in one single notify message. <b>Note:</b> The PBX server has to support this feature.</li> <li>• <b>Provision</b> Select this feature in order to make the phone trigger an instant provisioning.</li> </ul>
<b>Accounts</b>	Selects the account to be used with specific VPK.
<b>Description</b>	Enters a label for VPK.
<b>Value</b>	Specifies value for VPK depending on the mode selected.
<b>Locked</b>	Locks the VPK.
<b>Settings → Programmable Keys → Physical Multi-Purpose Keys (GRP2614 &amp; GRP2616 only)</b>	
<b>Order (1 – 24)</b>	Displays MPK index.
<b>Mode</b>	<p>Assigns a function to the corresponding physical MPK. This feature is available on GRP2614 &amp; GRP2616 only. The key mode options are:</p> <ul style="list-style-type: none"> <li>• <b>Speed Dial</b> Select the Account to dial from. And enter the Speed Dial number in the Value field to be dialed, or enter the IP address to set the Direct IP call as Speed Dial.</li> <li>• <b>Busy Lamp Field (BLF)</b> Select the Account to monitor the BLF status. Enter the extension number in the Value field to be monitored.</li> <li>• <b>Presence Watcher</b> This option has to be supported by a presence server and it is tied to the “Do Not Disturb” status of the phone’s extension.</li> <li>• <b>Eventlist BLF</b> This option is similar to the BLF option but in this case the PBX collects the information from the phones and sends it out in one single notify message. PBX server has to support this feature.</li> <li>• <b>Speed Dial via active account</b> Similar to Speed Dial but it will dial based on the current active account. For example, if the phone is offhook and account 2 is active, it will call</li> </ul>



the configured Speed Dial number using account 2.

- **Dial DTMF**

Enter a series of DTMF digits in the Value field to be dialed during the call. "Enable MPK Sending DTMF" has to be set to "Yes" first.

- **Voice Mail**

Select Account and enter the Voice Mail access number in the Value field.

- **Call Return**

The last answered calls can be dialed out by using Call Return. The Value field should be left blank. Also, this option is not binding to the account and the call will be returned based on the account with the last answered call.

- **Transfer**

Select Account, and enter the number in the Value field to be transferred (blind transfer) during the call.

- **Call Park**

Select Account, and enter the call park extension in the Value field to park /pick up the call.

- **Monitored Call Park**

Select account from Account field, and enter the call park extension in the Value field to park/pick up the call, and also monitor the parked call via Line Key's light.

- **Intercom**

Select Account, and enter the extension number in the Value field to do the intercom.

- **LDAP Search**

This option is to narrow the LDAP search scope. Enter the LDAP search base in the Description field. It could be the same or different from the Base in LDAP configuration under Advanced Settings.

The Base in LDAP configuration will be used if the Description field is left blank.

Enter the LDAP Name/Number filter in the Value field.

For example:

If users set MPK 1 as "LDAP Search" for "Account 1", and set filters:

**Description** -> ou=video,ou=SZ,dc=grandstream,dc=com

**Value** -> sn=Li



Since the Base for LDAP server configuration is:

“dc=78randstream,dc=com”, “ou=video,ou=SZ” is added to narrow the LDAP search scope. “sn=Li” is the example to filter the last name.

- **Conference**

Allow user to set their Multi-Purpose Key to “Conference” mode to trigger a conference.

By setting the extension number in the value box, the users will be able to activate a 3-way conference by simply press the assigned MPK button.

- **Multicast Paging**

This option is for multicast sending.

Enter Line key description in Description field and multicast sending address in Value field.

- **Record**

This option is for Recording calls. Enter Line key description in Description field and the recorded extension number in Value field. Make sure whether your VoIP provider supports this feature before using it.

- **Call Log**

Select Account and enter account number in the Value field to allow configuration of call log for other extension.

- **Menu**

Select this feature in order to display the Menu from the MPK buttons, no field dis required for configuration.

- **XML Application**

Select this feature in order to start the XML Application from the MPK buttons, no field dis required for configuration.

- **Information**

Select this feature in order to display the Information popup to show the firmware version, MAC address, IP address and IP Settings from the MPK buttons, no field dis required for configuration.

- **Message**

Select this feature in order to display the Message menu from the MPK buttons, no field dis required for configuration



	<ul style="list-style-type: none"> <li>• <b>Forward</b> Set the MPK Button to perform call forwarding to the destination number configured on the “Value Field”. During ringing press the button to perform the call forward.</li> <li>• <b>DND</b> Press the configured key to enabled/Disable DND.</li> <li>• <b>Redial</b> On this mode, the configured key can be used to redial numbers.</li> <li>• <b>Instant Messages</b> On this mode, the configured key can be used to enter IM menu and send new messages</li> <li>• <b>Multicast Listen Address</b> The MPK button can be used to access directly to the Multicast listening IP list.</li> <li>• <b>Keypad Lock</b> Configure the MPK button to be used to lock/unlock the keypad.</li> <li>• <b>GDS DoorOpen</b> Configure the VPK button to be used as GDS DoorOpen. Set PIN code in value field.</li> <li>• <b>Presence Eventlist</b> This option is similar to the Presence Watcher option but in this case the PBX collects the information from the phones and sends it out in one single notify message. PBX server has to support this feature.</li> <li>• <b>Provision</b> Select this feature in order to make the phone trigger an instant provisioning.</li> </ul>
<b>Account</b>	Selects the account to be used with specific MPK.
<b>Description</b>	Enters a label for MPK.
<b>Value</b>	Specifies value for MPK depending on the mode selected.
<b>Settings → Programmable Keys → Softkeys Settings</b>	
<b>More Softkey Display Mode</b>	Allows users to choose from the original Toggle mode or the enhanced Menu mode.



	With the enhanced Menu mode, the MORE softkey now will not need the user to tap multiple times on MORE to get to next pages, instead, pressing MORE will have a popup window and allow users to choose from the list. With Toggle mode, users need to press MORE softkey to switch between options. The default setting is “Menu”.
<b>Show Target Softkey</b>	Allows users to remove target softkey by toggle Yes/No option during the off-hook dial screen and transfer screen. The default setting is “Yes”.
<b>Softkey Layout</b>	
<b>Custom Softkey Layout</b>	Enables/Disables custom softkey layout. The default setting is “Disabled”.
<b>Enforce Softkey Layout Position</b>	Whether to enforce the custom softkey layout position. When enabled, GUI will still preserve the space if the configured softkey is unable to show. The default setting is “No”.
<b>Idle Screen Softkey Layout</b>	
<b>Hide System Softkey on Main Page</b>	Configures to hide the system generated softkey (Next, History, ForwardAll, Redial) on main page. Default value is none.
<b>Custom Call Screen Softkey Layout</b>	
<b>Dialing State</b>	<p>Customizes softkey layout when device is under Dialing State.</p> <ul style="list-style-type: none"> <li>• <b>Available Softkeys:</b> Phonebook(BT), BT On/Off, EndCall, ReConf, ConfRoom, Redial, Dial, Backspace, PickUp, Target, Show/Hide Label, Custom Softkey 1, Custom Softkey 2, Custom Softkey 3</li> <li>• <b>Default Softkeys:</b> Phonebook(BT), BT On/Off, EndCall, ReConf, ConfRoom, Redial, Dial, Backspace, PickUp, Target.</li> </ul>
<b>Onhook Dialing State</b>	<p>Customizes softkey layout when device is under OnHook Dialing State.</p> <ul style="list-style-type: none"> <li>• <b>Available Softkeys:</b> Phonebook(BT), DirectIP, Onhook, Cancel, Dial, Backspace, Target Show/Hide Label, Custom Softkey 1, Custom Softkey 2, Custom Softkey 3.</li> <li>• <b>Default Softkeys:</b> Phonebook(BT), DirectIP, Onhook, Cancel, Dial, Backspace, Target</li> </ul>
<b>Ringling State</b>	<p>Customizes softkey layout when device is under Ringling State.</p> <ul style="list-style-type: none"> <li>• <b>Available Softkeys:</b> Answer, Reject, Forward, ReConf, Show/Hide Label, Silence, Custom Softkey 1, Custom Softkey 2, Custom Softkey 3.</li> <li>• <b>Default Softkeys:</b> Answer, Reject, Forward, ReConf.</li> </ul>
<b>Calling State</b>	<p>Customizes softkey layout when device is under calling State.</p> <ul style="list-style-type: none"> <li>• <b>Available Softkeys:</b> BT On/Off, Cancel, EndCall, ReConf, ConfRoom, ConfCall. Show/Hide Label, Custom Softky 1, Custom Softkey 2,</li> </ul>





	<p>Custom Softkey 3.</p> <ul style="list-style-type: none"> <li>• <b>Default Softkeys:</b> BT On/Off, Cancel, EndCall, ReConf, ConfRoom, ConfCall.</li> </ul>
<b>Call Connected State</b>	<p>Customizes softkey layout when device is under call connected State.</p> <ul style="list-style-type: none"> <li>• <b>Available Softkeys:</b> Phonebook(BT), BT On/Off, EndCall, ReConf, ConfRoom, ConfCall, Cancel, NewCall, Swap, Transfer, Trnf&gt;VM, DialDTMF, BS-CCenter, Record On/Off(UCM), Record On/Off, CallPark(UCM), PrivateHold, CallPark. Show/Hide Label, Hold, Conference, Mute, Custom Softkey 1, Custom Softkey 2, Custom Softkey 3.</li> <li>• <b>Default Softkeys:</b> Phonebook(BT), BT On/Off, EndCall, ReConf, ConfRoom, ConfCall, Cancel, NewCall, Swap, Transfer, Trnf&gt;VM, DialDTMF, BS-CCenter, Record On/Off(UCM), Record On/Off, CallPark(UCM), PrivateHold, CallPark.</li> </ul>
<b>Conference Connected State</b>	<p>Customizes softkey layout when device is under Conference Connected State.</p> <ul style="list-style-type: none"> <li>• <b>Available Softkeys:</b> BT On/Off, EndCall, Kick, NewCall, Trnf&gt;VM, DialDTMF, BS-CCenter, Record On/Off(UCM), Record On/Off, ConfRoom, Add, Show/Hide Label, Hold, Split, Mute, Custom Softkey 1, Custom Softkey 2, Custom Softkey 3.</li> <li>• <b>Default Softkeys:</b> BT On/Off, EndCall, Kick, NewCall, Trnf&gt;VM, DialDTMF, BS-CCenter, Record On/Off(UCM), Record On/Off, ConfRoom, Add.</li> </ul>
<b>On Hold State</b>	<p>Customizes softkey layout when device is under On Hold State.</p> <ul style="list-style-type: none"> <li>• <b>Available Softkeys:</b> ReConf, Resume, Transfer, ConfCall, Add, Show/Hide Label, NewCall, EndCall, Custom Softkey 1, Custom Softkey 2, Custom Softkey 3.</li> <li>• <b>Default Softkeys:</b> ReConf, Resume, Transfer, ConfCall, Add.</li> </ul>
<b>Call Failed State</b>	<p>Customizes softkey layout when device is under Call Failed State.</p> <ul style="list-style-type: none"> <li>• <b>Available Softkeys:</b> EndCall, ReConf, ConfRoom, Show/Hide Label, NewCall, Custom Softkey 1, Custom Softkey 2, Custom Softkey 3.</li> <li>• <b>Default Softkeys:</b> EndCall, ReConf, ConfRoom.</li> </ul>
<b>Transfer State</b>	<p>Customizes softkey layout when device is under Transfer State.</p> <ul style="list-style-type: none"> <li>• <b>Available Softkeys:</b> BT On/Off, Cancel, BlindTrnf, AttTrnf, Backspace, Target, Show/Hide Label, Custom Softkey 1, Custom Softkey 2, Custom Softkey 3.</li> <li>• <b>Default Softkeys:</b> BT On/Off, Cancel, BlindTrnf, AttTrnf, Backspace,</li> </ul>



	Target.
<b>Conference State</b>	<p>Customizes softkey layout when device is under Conference State.</p> <ul style="list-style-type: none"> <li>• <b>Available Softkeys:</b> BT On/Off, Cancel, Dial, Backspace, Target, Show/Hide Label, Custom Softkey 1, Custom Softkey 2, Custom Softkey 3.</li> <li>• <b>Default Softkeys:</b> BT On/Off, Cancel, Dial, Backspace, Target.</li> </ul>
<b>Settings → Programmable Keys → Idle Screen Softkeys</b>	
<b>Order (1 – 2)</b>	<p>Displays Idle Screen Softkeys index. (1 – 2)</p> <p>The GRP26XX support 4 configurable Softkeys.</p> <p><b>Note:</b> The first and last Softkeys are reserved for Exit/More functionality.</p>
<b>Mode</b>	<p>Assigns a function to the corresponding Softkeys.</p> <p>The key mode options are:</p> <ul style="list-style-type: none"> <li>• <b>Speed Dial</b> Select the Account to dial from. And enter the Speed Dial number in the Value field to be dialed.</li> <li>• <b>Speed Dial via active account</b> Similar to Speed Dial but it will dial based on the current active account. For example, if the phone is offhook and account 2 is active, it will call the configured Speed Dial number using account 2.</li> <li>• <b>Voice Mail</b> Select Account &amp; enter the Voice Mail access number in the Value field.</li> <li>• <b>Call Return</b> The last answered calls can be dialed out by using Call Return. The Value field should be left blank. Also, this option is not binding to the account and the call will be returned based on the account with the last answered call.</li> <li>• <b>Intercom</b> Select Account, and enter the extension number in the Value field to do the intercom.</li> <li>• <b>LDAP Search</b> This option is to narrow the LDAP search scope. Enter the LDAP search base in the Description field. It could be the same or different from the Base in LDAP configuration under Advanced Settings. The Base in LDAP configuration will be used if the Description field is left blank. Enter the LDAP Name/Number filter in the Value field.</li> </ul>



	<p>For example: If users set MPK 1 as “LDAP Search” for “Account 1”, and set filters:</p> <p><b>Description</b> -&gt; ou=video,ou=SZ,dc=grandstream,dc=com</p> <p><b>Value</b> -&gt; sn=Li</p> <p>Since the Base for LDAP server configuration is “dc=83randstream,dc=com”, “ou=video,ou=SZ” is added to narrow the LDAP search scope. “sn=Li” is the example to filter the last name.</p> <ul style="list-style-type: none"> <li>• <b>Call Log</b> Select Account and enter account number in the Value field to access to the Call Log of that selected account.</li> <li>• <b>Menu</b> Select this feature in order to display the Menu from the MPK buttons, no field dis required for configuration.</li> <li>• <b>Information</b> Select this feature in order to display the Information popup to show the firmware version, MAC address, IP address and IP Settings from the MPK buttons, no field dis required for configuration.</li> <li>• <b>Message</b> Select this feature in order to display the Message menu from the MPK buttons, no field dis required for configuration</li> </ul>
<b>Account</b>	Selects the account to be used with specific softkey.
<b>Description</b>	Enters a label for softkey.
<b>Value</b>	Specifies value for softkey depending on the mode selected.
<b>Settings → Programmable Keys → Call Screen Softkeys</b>	
<b>Order (1 – 3)</b>	<p>Displays Idle Screen Softkeys index. (1 – 3)</p> <p><b>Note:</b> Make sure “Custom Softkey 1/2/3” are selected in [Custom Call Screen Softkey Layout].</p>
<b>Call Screen Softkeys</b>	<p>Assigns a function to the corresponding Call Screen Softkeys.</p> <ul style="list-style-type: none"> <li>• <b>Speed Dial</b> Select the Account to dial from. And enter the Speed Dial number in the Value field to be dialed.</li> <li>• <b>Speed Dial via active account</b> Similar to Speed Dial but it will dial based on the current active account. For example, if the phone is offhook and account 2 is active, it will call the configured Speed Dial number using account 2.</li> </ul>



- **Dial DTMF**  
Enter a series of DTMF digits in the Value field to be dialed during the call. “Enable MPK Sending DTMF” has to be set to “Yes” first.
- **Voice Mail**  
Select Account & enter the Voice Mail access number in the Value field.
- **Call Return**  
The last answered calls can be dialed out by using Call Return.  
The Value field should be left blank. Also, this option is not binding to the account and the call will be returned based on the account with the last answered call.
- **Intercom**  
Select Account, and enter the extension number in the Value field to do the intercom.
- **LDAP Search**  
This option is to narrow the LDAP search scope. Enter the LDAP search base in the Description field. It could be the same or different from the Base in LDAP configuration under Advanced Settings.  
The Base in LDAP configuration will be used if the Description field is left blank. Enter the LDAP Name/Number filter in the Value field.  
For example: If users set MPK 1 as “LDAP Search” for “Account 1”, and set filters:  
**Description** -> ou=video,ou=SZ,dc=grandstream,dc=com  
**Value** -> sn=Li  
Since the Base for LDAP server configuration is “dc=84randstream,dc=com”, “ou=video,ou=SZ” is added to narrow the LDAP search scope. “sn=Li” is the example to filter the last name.
- **Call Log**  
Select Account and enter account number in the Value field to access to the Call Log of that selected account.
- **Information**  
Select this feature in order to display the Information popup to show the firmware version, MAC address, IP address and IP Settings from the MPK buttons, no field dis required for configuration.
- **Message**  
Select this feature in order to display the Message menu from the MPK buttons, no field dis required for configuration



<b>Account</b>	Selects the account to be used with specific softkey.
<b>Description</b>	Enters a label for softkey.
<b>Value</b>	Specifies value for softkey depending on the mode selected.
<b>Settings → Web Service</b>	
<b>Use Auto Location Service</b>	Configures to enable or disable auto location services on the phone. (Reboot Required). The default setting is “Yes”.
<b>Auto Service Update</b>	Enables or disables automatic service update on phone. This configuration can enable the auto service update only when the Use Auto Location Service configuration is enabled. Default is “Yes”.
<b>Settings → XML Application</b>	
<b>Server Path</b>	Configures the server path to download the idle screen XML file. This field could be IP address or URL, with up to 256 characters.
<b>Softkey Label</b>	Specifies the Softkey name displayed on the idle screen for the users to enter XML application. The default Softkey Label is “XMLApp”.
<b>Default Background Color</b>	Enters a color to use in HEX format. Default will be transparent. E.g. #000000. Reference: <a href="http://htmlcolorcodes.com">http://htmlcolorcodes.com</a>
<b>Block Call Screen</b>	Permits to block auto-switching to call screen when XML application is running. Default is disabled.
<b>Settings → Voice Monitoring</b>	
<b>Session Report</b>	
<b>VQ RTCP-XR Session Report</b>	When enabled, phone will send a session quality report to the central report collector at the end of each call. The default setting is “Disabled”.
<b>Interval Report</b>	
<b>VQ RTCP-XR Interval Report</b>	When enabled, phone will send an interval quality report to the central report collector periodically throughout a call. The default setting is “Disabled”.
<b>VQ RTCP-XR Interval Report Period</b>	Configure the interval (in seconds) of phone sending an interval quality report to the central report collector periodically throughout a call. Default is 20 seconds.
<b>Alert Report</b>	
<b>Warning Threshold for Moslq</b>	Configure the threshold value of listening MOS score (MOS-LQ) multiplied by 10. The threshold value of MOS-LQ causes the phone to send a warning alert quality report to the central report collector. The valid range is 0 – 49. The default value is “0”.
<b>Critical Threshold for Moslq</b>	Configure the threshold value of listening MOS score (MOS-LQ) multiplied by 10. The threshold value of MOS-LQ causes the phone to send a critical



	alert quality report to the central report collector. The valid range is 0 – 49. The default value is “0”.
<b>Warning Threshold for Delay</b>	Configure the threshold value of one way delay (in milliseconds) that causes the phone to send a warning alert quality report to the central report collector. The valid range is 0 – 65535 The default value is “0”.
<b>Critical Threshold for Delay</b>	Configure the threshold value of one way delay (in milliseconds) that causes the phone to send a warning alert quality report to the central report collector. The valid range is 0 – 65535 The default value is “0”.
<b>Display Report</b>	
<b>Display Report on Web UI</b>	When enabled, phone will display quality report on WEB UI. The default setting is “Disabled”.
<b>Display Report on LCD</b>	When enabled, phone will display quality report on LCD. The default setting is “Disabled”
<b>Custom Display Layout on LCD</b>	When enabled, phone will display quality report on LCD. Press “Modify” button to select info to display. Available/Default options are: Start Time, Stop Time, Local User ID, Remote User ID, Local User IP, Remote User IP, Local User Codec, Remote User Codec, Jitter, Jitter Buffer Max, Packets Lost, Network Packet Loss Rate, MOS-LQ, MOS-CQ, Round Trip Delay, End System Delay, Symmetric One Way Delay.

## Network Page Definitions

Table 12: Network Page Definitions

<b>Network → Basic Settings</b>	
<b>Internet Protocol</b>	Selects “IPv4 Only”, “IPv6 Only”, “Both, prefer IPv4” or “Both, prefer IPv6”. The default setting is “IPv4 only”.
<b>IPv4 Address</b>	
<b>IPv4 Address</b>	Allows users to configure the appropriate network settings on the phone to obtain IPv4 address. Users could select “DHCP”, “Static IP” or “PPPoE”. By default, it is set to “DHCP”.
<b>Host name (Option 12)</b>	Specifies the name of the client. This field is optional but may be required by some Internet Service Providers.
<b>DHCP Vendor Class ID (Option 60)</b>	Used by clients and servers to exchange vendor class ID. The default setting is “Grandstream GRP2612” for GRP2612, “Grandstream GRP2612P” for GRP2612P, “Grandstream GRP2612W” for GRP2612W, “Grandstream GRP2613” for GRP2613, “Grandstream GRP2614” for GRP2614, “Grandstream GRP2615” for GRP2615 and “Grandstream GRP2616” for GRP2616.
<b>PPPoE Account ID</b>	Enter the PPPoE account ID.



<b>PPPoE Password</b>	Enter the PPPoE Password.
<b>PPPoE Service Name</b>	Enter the PPPoE Service Name.
<b>Ipv4 Address</b>	Enter the IP address when static IP is used.
<b>Subnet Mask</b>	Enter the Subnet Mask when static IP is used for IPv4.
<b>Gateway</b>	Enter the Default Gateway when static IP is used for IPv4.
<b>DNS Server 1</b>	Enter the DNS Server 1 when static IP is used for IPv4.
<b>DNS Server 2</b>	Enter the DNS Server 2 when static IP is used for IPv4.
<b>Preferred DNS Server</b>	Enters the Preferred DNS Server for Ipv4.
<b>IPv6 Address</b>	
<b>IPv6 Address Type</b>	Allows users to configure the appropriate network settings on the phone to obtain IPv6 address. Users could select “Auto-configured” or “Statically configured” for the IPv6 address type.
<b>Static IPv6 Address</b>	Enter the static IPv6 address when Full Static is used in “Statically configured” Ipv6 address type.
<b>IPv6 Prefix Length</b>	Enter the IPv6 prefix length when Full Static is used in “Statically configured” Ipv6 address type.
<b>Ipv6 Prefix</b>	Enter the IPv6 Prefix (64 bits) when Prefix Static is used in “Statically configured” IPv6 address type.
<b>DNS Server 1</b>	Enter the DNS Server 1 for IPv6.
<b>DNS Server 2</b>	Enter the DNS Server 2 for IPv6.
<b>Preferred DNS server</b>	Enter the Preferred DNS Server for IPv6.
<b>Network → Advanced Settings</b>	
<b>802.1X mode</b>	Allows the user to enable/disable 802.1X mode on the phone. The default value is disabled. To enable 802.1X mode, this field should be set to EAP-MD5, users may also choose EAP-TLS, or EAP-PEAPv0/MSCHAPv2.
<b>802.1X Identity</b>	Enter the Identity information for the 802.1x mode. <b>Note:</b> Letters, digits and special characters including @ and – are accepted.
<b>MD5 Password</b>	Enter the MD5 Password for the 802.1X mode. <b>Note:</b> Letters, digits and special characters including @ and – are accepted.
<b>802.1X CA Certificate</b>	Uploads / deletes the 802.1X CA certificate to the phone; or delete existed 802.1X CA certificate from the phone.
<b>802.1X Client Certificate</b>	Uploads / deletes 802.1X Client certificate to the phone; or delete existed 802.1X Client certificate from the phone.
<b>HTTP Proxy</b>	Specifies the HTTP proxy URL for the phone to send packets to. The proxy server will act as an intermediary to route the packets to the destination.
<b>HTTPS Proxy</b>	Specifies the HTTPS proxy URL for the phone to send packets to. The proxy server will act as an intermediary to route the packets to the destination.
<b>Bypass Proxy For</b>	Enter host names that do not require a proxy to reach. Those names should



	be separated by commas.
<b>Layer 3 QoS for SIP</b>	Defines the Layer 3 QoS parameter for SIP. This value is used for IP Precedence, Diff-Serv or MPLS. The default value is 26.
<b>Layer 3 QoS for RTP</b>	Defines the Layer 3 QoS parameter for RTP. This value is used for IP Precedence, Diff-Serv or MPLS. The default value is 46.
<b>Enable DHCP VLAN</b>	Enables auto configure for VLAN settings through DHCP. Disabled by default.
<b>Enable Manual VLAN Configuration</b>	Enables/disables manual VLAN configuration. When this option is set to Disabled, the phone will bypass VLAN configuration and only use the DHCP VLAN to configure VLAN tag and priority. Default is "Enabled".
<b>Layer 2 QoS 802.1Q/VLAN Tag</b>	Assigns the VLAN Tag of the Layer 2 QoS packets. The valid range is 0 – 4094. The default value is 0.
<b>Layer 2 QoS 802.1p Priority Value</b>	Assigns the priority value of the Layer2 QoS packets. The valid range is 0 – 7. The default value is 0.
<b>PC Port Mode</b>	Configure the PC port mode. When set to "Mirrored", the traffic in the LAN port will go through PC port as well and packets can be captured by connecting a PC to the PC port. The default setting is "Enabled".
<b>PC Port VLAN Tag</b>	Assigns the VLAN Tag of the PC port. The valid range is 0 – 4094. The default value is 0.
<b>PC Port Priority Value</b>	Assigns the priority value of the PC port. The valid range is 0 – 7. The default value is 0.
<b>Enable CDP</b>	Enables/Disables CDP "Cisco Discovery Protocol". The default setting is "Enabled".
<b>Enable LLDP</b>	Controls the LLDP (Link Layer Discovery Protocol) service. The default setting is "Enabled".
<b>LLDP TX Interval</b>	Defines LLDP TX Interval (in seconds). Valid range is 1 to 3600. The default setting is "60".
<b>Maximum Transmission Unit (MTU)</b>	Defines the MTU in bytes. The valid range is 576 – 1500. The default value is 1500 bytes.
<b>Network → Remote Control</b>	
<b>Action URI Support</b>	Enables/disables action URI feature on the phone. The default setting is "Enabled".
<b>Remote control Pop up window support</b>	Indicates whether the phone is enabled to pop up allow remote control. The default setting is "Enabled".





<b>Action URI allowed IP list</b>	List of allowed IP address from which the phone receives action URI. The Allowed IP addresses are separated by a comma such as "192.168.1.1,192.168.1.2". Set this field to "any" to allow any IP address to send Action URL to the phone. The default value is empty string which means no IP address is allowed for remotely control the phone.
<b>CSTA Control</b>	Indicates whether CSTA Control feature is enabled. Change of this configuration will need the system to reboot to take effect. The default setting is "Disabled".
<b>Network → Affinity Settings (GRP2614, GRP2615 &amp; GRP2616 only)</b>	
<b>Affinity Support</b>	Allows communication with GS Affinity CTI application to manage telephone calls from computer. If enabled, a reboot is required to establish the communication. Default is "Disabled". GS Affinity CTI Application is available <a href="#">HERE</a> and its User Guide <a href="#">HERE</a> .
<b>Preferred Account</b>	Selects the account on which CTI support is enabled.
<b>Network → Bluetooth Settings (GRP2614, GRP2615 &amp; GRP2616 only)</b>	
<b>Bluetooth Power</b>	Configures Bluetooth to power "On", "Off" or "Off & Hide Menu From LCD". If set "Off & Hide Menu From LCD", Bluetooth will be disabled, and users will not find Bluetooth settings on phone LCD Menu, while if set to "No", Bluetooth will be disabled, and Bluetooth Settings menu will be available, and user can enable it. The default setting is "On".
<b>Handsfree Mode</b>	Enable / disable Bluetooth handsfree feature. Default setting is "Off".
<b>Bluetooth Name</b>	Specifies the Bluetooth device name.
<b>Network → OpenVPN® Settings</b>	
<b>OpenVPN® Enable</b>	Enables/Disables OpenVPN® feature. Default is "No".
<b>OpenVPN® Server Address</b>	Specify the IP address or FQDN for the OpenVPN® Server.
<b>OpenVPN® Port</b>	Specify the listening port of the OpenVPN® server. The valid range is 1 – 65535. The default value is "1194".
<b>OpenVPN® Transport</b>	Specify the Transport Type of OpenVPN® whether UDP or TCP. The default value is "UDP".
<b>OpenVPN® CA</b>	Click on "Upload" to upload the Certification Authority of OpenVPN®. For a new upload, users could click on "Delete" to erase the last certificate, and then upload a new one.
<b>OpenVPN® Certificate</b>	Click on "Upload" to upload OpenVPN® certificate. For a new upload, users could click on "Delete" to erase the last certificate, and then upload a new one.
<b>OpenVPN® Client Key</b>	Click on "Upload" to upload OpenVPN® Key.



	For a new upload, users could click on “Delete” to erase the last certificate, and then upload a new one.
<b>OpenVPN® Cipher Method</b>	<p>Specifies the Cipher method used by the OpenVPN® server. The available options are:</p> <ul style="list-style-type: none"> <li>• <b>Blowfish</b></li> <li>• <b>AES-128</b></li> <li>• <b>AES-256</b></li> <li>• <b>Triple-DES</b></li> </ul> <p>The default setting is “Blowfish”.</p>
<b>OpenVPN® Username</b>	Configures the optional username for authentication if the OpenVPN server supports it.
<b>OpenVPN® Password</b>	Configures the optional password for authentication if the OpenVPN server supports it.
<b>Additional Options</b>	<p>Additional options to be appended to the OpenVPN® config file, separated by semicolons. For example, comp-lzo no;auth SHA256</p> <p><b>Note:</b> Please use this option with caution. Make sure that the options are recognizable by OpenVPN® and do not unnecessarily override the other configurations above.</p>

### Network → SNMP Settings

<b>Enable SNMP</b>	Enables/Disables the SNMP feature. Default settings is “No”.
<b>Version</b>	<p>SNMP version. Select Version 1, Version 2 or Version 3.</p> <p>Default is “Version 3”.</p>
<b>Port</b>	SNMP port. The valid range is 161, 1025-65535. The default value is “161”.
<b>Community</b>	SNMP Community.
<b>SNMP Trap Version</b>	<p>Trap version of the SNMP trap receiver.</p> <ul style="list-style-type: none"> <li>• <b>Trap Version 1</b></li> <li>• <b>Trap Version 2</b></li> <li>• <b>Trap Version 3</b></li> </ul> <p>The default is “Trap Version 2”.</p>
<b>SNMP Trap IP</b>	IP address of the SNMP trap receiver.
<b>SNMP Trap Port</b>	Port of the SNMP trap receiver. The valid range is 162, 1025-65535. The default value is “162”.
<b>SNMP Trap Interval</b>	The interval between each trap sent to the trap receiver. The valid range is 1 – 1440. The default value is “5”.



<b>SNMP Trap Community</b>	Community string associated to the trap. It must match the community string of the trap receiver.
<b>SNMP Username</b>	Username for SNMPv3
<b>Security Level</b>	<ul style="list-style-type: none"> <li>• <b>noAuthUser:</b> Users with security level noAuthnoPriv and context name as noAuth.</li> <li>• <b>authUser:</b> Users with security level authNoPriv and context name as auth.</li> <li>• <b>privUser:</b> Users with security level authPriv and context name as priv.</li> </ul>
<b>Authentication Protocol</b>	<p>Select the Authentication Protocol:</p> <ul style="list-style-type: none"> <li>• <b>None</b></li> <li>• <b>MD5</b></li> <li>• <b>SHA</b></li> </ul> <p>The default setting is “None”.</p>
<b>Privacy Protocol</b>	<p>Select the Privacy Protocol:</p> <ul style="list-style-type: none"> <li>• <b>None</b></li> <li>• <b>DES</b></li> <li>• <b>AES</b></li> </ul> <p>The default setting is “None”.</p>
<b>Authentication Key</b>	Enter the Authentication Key.
<b>Privacy Key</b>	Enter the Privacy Key.
<b>SNMP Trap Username</b>	Username for SNMPv3 Trap.
<b>Trap Security Level</b>	<ul style="list-style-type: none"> <li>• <b>noAuthUser:</b> Users with security level noAuthnoPriv and context name as noAuth.</li> <li>• <b>authUser:</b> Users with security level authNoPriv and context name as auth.</li> <li>• <b>privUser:</b> Users with security level authPriv and context name as priv.</li> </ul>
<b>Trap Authentication Protocol</b>	<p>Select the Trap Authentication Protocol:</p> <ul style="list-style-type: none"> <li>• <b>None</b></li> <li>• <b>MD5</b></li> <li>• <b>SHA</b></li> </ul> <p>The default setting is “None”.</p>
<b>Trap Privacy Protocol</b>	<p>Select the Trap Privacy Protocol:</p> <ul style="list-style-type: none"> <li>• <b>None</b></li> </ul>



	<ul style="list-style-type: none"><li>• <b>DES</b></li><li>• <b>AES</b></li></ul> <p>The default setting is “None”.</p>
<b>Trap Authentication Key</b>	Enter the Trap Authentication Key
<b>Trap Privacy Key</b>	Enter the Trap Privacy Key.



**Network → WiFi Settings (Available on GRP2612W & GRP2614 & GRP2615 & GRP2616 only)**

<b>Enable/Disable WiFi</b>	Enables / Disables the WiFi on the phone. Three options are available: <ul style="list-style-type: none"> <li>• <b>No:</b> Disables WiFi. User has ability to enable WiFi from LCD Menu.</li> <li>• <b>Off &amp; Hide Menu from LCD:</b> Disables WiFi and hides “WiFi Settings” menu from phone LCD.</li> <li>• <b>Yes:</b> Enables WiFi to connect to WiFi network.</li> </ul> Default setting is “No”.	
<b>Country</b>	Specifies the Wi-Fi encryption type.	
<b>Access Point (1 - 10)</b>	<b>SSID</b>	Enters WiFi SSID name to connect.
	<b>Password</b>	Configures the authentication password to access WiFi Network.
	<b>Security Type</b>	Specifies the WiFi encryption type. The available options are the following: None, WEP, WPA, WPA Enterprise and Auto. Default settings is None.

## Maintenance Page Definitions

Table 13 : Maintenance Page Definitions

**Maintenance → Web Access**
**User Password**

<b>New Password</b>	Set new password for web GUI access as User. This field is case sensitive.
<b>Confirm Password</b>	Enter the new User password again to confirm.

**Admin Password**

<b>Current Password</b>	The current admin password is required for setting a new admin password.
<b>New Password</b>	Set new password for web GUI access as Admin. This field is case sensitive.
<b>Confirm Password</b>	Enter the new Admin password again to confirm.

**Maintenance → Upgrade and Provisioning**

<b>Firmware Upgrade and Provisioning</b>	Specifies how firmware upgrading and provisioning request to be sent: Always Check for New Firmware, Check New Firmware only when F/W pre/suffix changes, Always Skip the Firmware Check. The default setting is “Always Check for New Firmware”.
<b>Always Authenticate Before Challenge</b>	Only applies to HTTP/HTTPS. If enabled, the phone will send credentials before being challenged by the server. The default setting is “No”.
<b>Validate Hostname in Certificate</b>	Allows to validate the hostname in the SSL certificate. The default setting is “No”.
<b>Allow DHCP Option 43 and Option 66 Override Server</b>	DHCP option 66 originally was only designed for TFTP server. Later on, it was extended to support an HTTP URL. GRP phones support both TFTP and HTTP server via option 66. Users can also use DHCP option 43 vendor specific option to do this.



	DHCP option 43 approach has priorities. The phone is allowed to fall back to the original server path configured in case the server from option 66 fails. The default setting is “Yes”.
<b>Additional Override DHCP Option</b>	When enabled, users could select Option 150 or Option 160 to override the firmware server instead of using the configured firmware server path or the server from option 43 and option 66 in the local network. Please note this option will be effective only when option “Allow DHCP Option 43 and Option 66 to Override Server” is enabled. The default setting is “None”.
<b>Allow DHCP Option 120 to override SIP Server</b>	Enables DHCP Option 120 from local server to override the SIP Server on the phone. The default setting is “No”.
<b>3CX Auto Provision</b>	Enables automatic provisioning feature (PNP) on the phone when 3CX is used as the SIP server. The default setting is “Yes”.
<b>Automatic Upgrade</b>	Enables automatic upgrade and provisioning. The default setting is “No”.
<b>Randomized Automatic Upgrade</b>	Randomized Automatic Upgrade within the range of hours of the day or postpone the upgrade every X minute(s) by random 1 to X minute(s). The default setting is “No”.
<b>Hour of the Day (0-23)</b>	Defines the hour of the day to check the HTTP/TFTP/FTP server for firmware upgrades or configuration files changes. The default value is 1.
<b>Day of the Week (0-6)</b>	Defines the day of the week to check HTTP/TFTP/FTP server for firmware upgrades or configuration files changes. The default value is 1.
<b>Disable SIP NOTIFY Authentication</b>	Device will not challenge NOTIFY with 401 when set to “Yes”. Default setting is “No”.
<b>Firmware Upgrade Confirmation</b>	If set to "Yes", the phone will ask the user to upgrade. If there is no response, the phone will proceed with the upgrade. If set to "No", the phone will automatically upgrade without user input. Default is Yes.
<b>Config</b>	
<b>Config Upgrade Via</b>	Allows users to choose the config upgrade method: TFTP, FTP, FTPS, HTTP or HTTPS. The default setting is “HTTPS”.
<b>Config Server Path</b>	Defines the server path for provisioning.
<b>Config HTTP/HTTPS User Name</b>	The user name for the HTTP/HTTPS server.
<b>Config HTTP/HTTPS Password</b>	The password for the HTTP/HTTPS server.
<b>Config File Prefix</b>	Enables your ITSP to lock configuration updates. If configured, only the configuration file with the matching encrypted prefix will be downloaded and flashed into the phone.



<b>Config File Postfix</b>	Enables your ITSP to lock configuration updates. If configured, only the configuration file with the matching encrypted postfix will be downloaded and flashed into the phone.
<b>XML Config File Password</b>	The password for encrypting XML configuration file using OpenSSL. This is required for the phone to decrypt the encrypted XML configuration file.
<b>Authenticate Conf File</b>	Sets the phone system to authenticate configuration file before applying it. When set to “Yes”, the configuration file must include value P1 with phone system’s administration password. If it is missed or does not match the password, the phone system will not apply it. Default setting is “No”.
<b>Download Device Configuration</b>	Click to download phone’s configuration file in .txt format. <b>Note:</b> Configuration file doesn’t include passwords or CA/Custom certificate
<b>Download Device Configuration (XML)</b>	Click to download phone’s configuration file in .xml format. <b>Note:</b> Configuration file doesn’t include passwords or CA/Custom certificate
<b>User protection</b>	When user protection is on, pvalues that user sets will not be changed by provision or provider. <ul style="list-style-type: none"> <li>• If “User protection” is <b>OFF</b>, everyone (Provider, user or admin) has access to most of the Pvalues.</li> <li>• If “User protection” is <b>ON</b>, only those (normally user or admin) who have privilege can modify the configuration.</li> </ul> <p>The default setting is “Off”.</p>
<b>Download and Process All Available Config Files</b>	By default, device will provision the first available config in the order of cfgMAC, cfgMAC.xml, cfgMODEL.xml and cfg.xml (corresponding to device specific, model specific and global configs). If this option is enabled, the phone will inverse the downloading process to cfg.xml > cfgGRP26XX.xml > cfgMAC.bin > cfgMAC.xml. The following files will override the files that has already been load and processed. The default setting is “No”.
<b>Download User configuration</b>	This allows users to download part of the configuration that does not include any personal settings like Username and Passwords. Also, it will include all the changes manually made by user from web UI, or config file uploaded from “Upload Device Configuration”, but not include the changes from the server provision via TFTP/FTP/FTPS/HTTP/HTTPS.
<b>Upload Device Configuration</b>	Uploads configuration file to phone.
<b>Export backup Package</b>	Export backup package which contains device configuration along with personal data.
<b>Restore from Backup package</b>	Click to upload backup package and restore.



Firmware	
<b>Firmware Upgrade Via</b>	Allows users to choose the firmware upgrade method: TFTP, FTP, FTPS, HTTP or HTTPS. The default setting is "HTTP".
<b>Firmware Server Path</b>	Defines the server path for the firmware server.
<b>Firmware HTTP/HTTPS User Name</b>	The user name for the HTTP/HTTPS server.
<b>Firmware HTTP/HTTPS Password</b>	The password for the HTTP/HTTPS server.
<b>Firmware File Prefix</b>	Enables your ITSP to lock firmware updates. If configured, only the firmware with the matching encrypted prefix will be downloaded and flashed into the phone.
<b>Firmware File Postfix</b>	Enables your ITSP to lock firmware updates. If configured, only the firmware with the matching encrypted postfix will be downloaded and flashed into the phone.
Maintenance → Syslog	
<b>Syslog Protocol</b>	If set to SSL/TLS, the syslog messages will be sent through secured TLS protocol to syslog server. Default setting is "UDP". <b>Note:</b> The CA certificate is required to connect with the TLS server.
<b>Syslog Server</b>	The URL or IP address of the syslog server for the phone to send syslog to. <b>Note:</b> By adding port number to the Syslog server field (i.e 172.18.1.1:1000), the phone will send syslog to the corresponding port of that IP.
<b>Syslog Level</b>	Selects the level of logging for syslog. The default setting is "None". There are 4 levels: DEBUG, INFO, WARNING and ERROR. Syslog messages are sent based on the following events: <ul style="list-style-type: none"> <li>• Product model/version on boot up (INFO level);</li> <li>• NAT related info (INFO level);</li> <li>• sent or received SIP message (DEBUG level);</li> <li>• SIP message summary (INFO level);</li> <li>• inbound and outbound calls (INFO level);</li> <li>• registration status change (INFO level);</li> <li>• negotiated codec (INFO level);</li> <li>• Ethernet link up (INFO level);</li> <li>• SLIC chip exception (WARNING and ERROR levels);</li> <li>• Memory exception (ERROR level).</li> </ul>





<b>Syslog Keyword Filtering</b>	Syslog will be filtered based on keywords provided. If you enter multiple keywords, it should be separated by ','. Please note that no spaces are allowed.
<b>Send SIP Log</b>	Configures whether the SIP log will be included in the syslog messages. The default setting is "No". <b>Note:</b> By setting Send SIP Log to Yes, the phone will still send SIP log from syslog even when Syslog Level set to NONE.
<b>Show Internet Down Message</b>	If enabled, the internet down warning message will display when internet is down. The default setting is "No".
<b>Auto Recover From Abnormal</b>	If set to "Yes", the phone will automatically recover when running abnormal. The default setting is "Yes".

### Maintenance → TR-069

<b>ACS URL</b>	Specifies URL of TR-069 ACS (e.g.,http://acs.mycompany.com), or IP address. Default setting is "https://acs.gdms.cloud"
<b>TR-069 Username</b>	ACS username for TR-069.
<b>TR-069 Password</b>	ACS password for TR-069.
<b>Periodic Inform Enable</b>	Enables periodic inform. If set to "Yes", device will send inform packets to the ACS. The valid range is 1 – 4294967295. The default setting is "Yes".
<b>Periodic Inform Interval</b>	Sets up the periodic inform interval to send the inform packets to the ACS. The default value is "86400".
<b>Connection Request Username</b>	The username for the ACS to connect to the phone.
<b>Connection Request Password</b>	The password for the ACS to connect to the phone.
<b>Connection Request Port</b>	The port for the ACS to connect to the phone. The default value is "7547".
<b>CPE SSL Certificate</b>	The Cert File for the phone to connect to the ACS via SSL.
<b>CPE SSL Private Key</b>	The Cert Key for the phone to connect to the ACS via SSL.
<b>Randomized TR069 Startup</b>	When enabled, this option allows users to randomize the sending of TR069 INFORM packets. The default setting is "Disabled".

### Maintenance → Security Settings → Security

<b>Configuration via Keypad Menu</b>	Configures the access control for the users to configure from keypad Menu. There are three different options: <ul style="list-style-type: none"> <li>• <b>Unrestricted:</b> All the options can be accessed in keypad Menu.</li> <li>• <b>Basic settings only:</b> The SIP option under Phone submenu, and Network, Upgrade, UCM Detect and Factory Reset options under System submenu will not be available in LCD Menu.</li> </ul>
--------------------------------------	--



	<ul style="list-style-type: none"> <li>• <b>Constraint Mode:</b> The phone will require administration password to change the Network, Upgrade and Factory Reset options under System submenu, and SIP option under Phone submenu as well.</li> <li>• <b>Locked Mode:</b> The phone menu and changing MPK/VPK/Line are disabled.</li> </ul> <p>The default setting is “Unrestricted”.</p>
<b>Allow Configure MPK through LCD</b>	Enable/Disable configuration of MPKs through LCD by long pressing MPKs. This option is available on GRP2614 & GRP2616 only. The default setting is “Yes”.
<b>Validate Server Certificates</b>	After enabling this feature, phone will validate the server’s certificate. If the server that our phone tries to register on is not on our list, it will not allow server to access the phone.
<b>SIP TLS Certificate</b>	SSL Certificate used for SIP Transport in TLS/TCP.
<b>SIP TLS Private Key</b>	SSL Private key used for SIP Transport in TLS/TCP.
<b>SIP TLS Private Key Password</b>	SSL Private key password used for SIP Transport in TLS/TCP.
<b>Custom Certificate</b>	The uploaded custom certificate will be used for SSL/TLS communication instead of the GRP phone default certificate.
<b>Web Access Mode</b>	<p>Sets the protocol for web interface.</p> <ul style="list-style-type: none"> <li>• <b>HTTPS</b></li> <li>• <b>HTTP</b></li> <li>• <b>Disabled</b></li> <li>• <b>Both HTTP and HTTPS</b></li> </ul> <p>The default setting is “HTTP”.</p>
<b>Enable User Web Access</b>	Administrator can disable or enable user web access. The default setting is “Enabled”.
<b>HTTP Web Port</b>	Configures the HTTP port under the HTTP web access mode. The valid range is 80 – 65535. The default value is “80”.
<b>HTTPS Web Port</b>	Configures the HTTPS port under the HTTPS web access mode. The valid range is 443 – 65535. The default setting is “443”.
<b>Disable SSH</b>	Disables SSH access. The default setting is “No”.
<b>SSH Public Key</b>	<p>This option allows you to use authentication keys for SSH access. The public key should be loaded to phone’s web UI while the private key should be used in the SSH tool side.</p> <p><b>Note:</b> This will allow upcoming SSH access without password.</p>
<b>Web/Keypad/Restrict mode Lockout Duration</b>	Specifies the time in minutes that the web or LCD login interface will be locked out to user after five login failures. This lockout time is used for web login, STAR keypad unlock, and LCD restrict mode admin login. Range is 0-60 minutes. The default setting is “5”.



<b>Web Session Timeout</b>	Configures timer to logout web session during idle. The valid range is 2-60 min. The default value is 10 min
----------------------------	--

<b>Web Access Attempt Limit</b>	Configures attempt limit before lockout. The valid range is 1 – 10. The default value is “5”.
---------------------------------	---

### Maintenance → Security Settings → Trusted CA Certificates

<b>Trusted CA Certificates (1 – 6)</b>	Allows to upload and delete the CA Certificate file to phone.  <b>Note:</b> Users can either upload the file directly from web or they can choose to provision it from their cfg.xml file.
--	--

<b>Load CA Certificates</b>	Phone will verify the server certificate based on the built-in, custom or both trusted certificates list. The default setting is “Default Certificates”.
-----------------------------	--

### Maintenance → Security Settings → Keypad Lock

<b>Enable Keypad Locking</b>	If set to “Yes” the keypad can be locked either manually by pressing for 4 seconds * key or pressing a VPK/MPK which set to “keypad lock” mode, also the keypad will be locked automatically after the configured timer. The default setting is “No”.
------------------------------	---

<b>Keypad Lock Type</b>	<ul style="list-style-type: none"> <li>If set to <b>“Functional Keys”</b>, only “Functional Keys” will be locked but you are still allowed to dial out emergency calls</li> <li>If set to <b>“All Keys”</b>, all keys will be locked and no emergency calls are allowed.</li> </ul> The default setting is “All Keys”.
-------------------------	--

<b>Password to Lock/Unlock</b>	Set the password to Unlock the keypad.
--------------------------------	--

<b>Keypad Lock Timer</b>	Configure the idle screen timer after which the keypad will be automatically locked. The valid range is 0 – 3600. The default value is “0”.
--------------------------	---

<b>Emergency</b>	Enter list of allowed emergency numbers when keypad is locked (separate the numbers with “,”). The default value is “112,911,110”.
------------------	--

### Maintenance → Packet Capture

<b>Status</b>	Displays packet capture status. When user starts to capture trace file, it will show “RUNNING” status, otherwise, it will show “STOPPED”.
---------------	---

<b>With RTP Packets</b>	Defines whether the packet capture file contains RTP or not. The default setting is “No”.
-------------------------	---

### Maintenance → Tools

<b>Provision</b>	For more details, please refer to [GRP26XX TOOLS].
<b>Factory Reset</b>	
<b>Ping</b>	
<b>Traceroute</b>	



## Directory Page Definitions

Directory → Contacts	
<b>Search Bar</b>	Allows users searching for phonebook entries.
<b>Add Contact</b>	Specifies Contact's First Name, Last Name, Phone Number, Accounts and Groups (Blacklist, Whitelist, Work, Friends and Family) to add one new contact in phonebook. <b>Note:</b> If the contact number belongs to Blacklist group, the call from this number will be blocked. If the contact number belongs to Whitelist group, when the phone is on DND mode, the call from whitelist number will be allowed.
<b>Edit Contact</b>	Edits selected contact.
<b>Delete All Contacts</b>	Deletes all contacts from phonebook. <b>Note:</b> a message prompt will be displayed so that users will confirm to delete or cancel the operation, in order to prevent users from losing contacts when deleting them accidentally.
Directory → Group Management	
<b>Add Group</b>	Specifies Group's name to add new group. More than 30 Groups supported.
<b>Edit Group</b>	Edits selected group.
Directory → Phonebook Management	
<b>Enable Phonebook XML Download</b>	Configures to enable phonebook XML download. Users could select HTTP/HTTPS/TFTP to download the phonebook file. The default setting is "Disabled".
<b>HTTP/HTTPS User Name</b>	The user name for the HTTP/HTTPS server.
<b>HTTP/HTTPS Password</b>	The password for the HTTP/HTTPS server.
<b>Phonebook XML Server Path</b>	Configures the server path to download the phonebook XML. This field could be IP address or URL, with up to 256 characters.
<b>Phonebook Download Interval</b>	Configures the phonebook download interval (in minutes). If it's set to 0, the automatic download will be disabled. The default value is 0. The valid range is 5 to 720 minutes.
<b>Remove Manually-edited Entries on Download</b>	If set to "Yes", when XML phonebook is downloaded, the entries added manually will be automatically removed. The default setting is "Yes".
<b>Import Group Method</b>	<ul style="list-style-type: none"> <li>When set to "<b>Replace</b>", existing groups will be completely replaced by imported one;</li> <li>When set to "<b>Append</b>", the imported groups will be attended with the current one.</li> </ul> The default setting is "Replace".



<b>Sort Phonebook by</b>	Sort phonebook based on the selection of first name or last name. The default setting is "Last Name".
<b>Download XML Phonebook</b>	Click on "Download" to download the XML phonebook file to local PC
<b>Upload XML Phonebook</b>	Click on "Upload" to upload local XML phonebook file to the phone.
<b>Phonebook Key Function</b>	Control the behavior of phonebook key. There are five options: Default, LDAP Search, Local Phonebook, Local Group, and Broadsoft Phonebook. The default setting is "Default", when user presses it, phone LCD will show the five options.
<b>Default search mode</b>	<p>Configures default phonebook search mode.</p> <ul style="list-style-type: none"> <li>• <b>Quick Match:</b> The quick search feature allows users to search parts and strings of the entries. For instance, if users only remember the first name, last name or parts of the name / phone number, they can use the string in the search bar.</li> <li>• <b>Exact Match:</b> Users can search their contacts using alphabets in the exact mode which allows them to find their contacts even if they forget the numbers. To perform this type of search, make sure that search type is set to "Exact Match" then you can enter the exact name of the contact for lookup.</li> </ul> <p>The default setting is "Quick Match".</p>
<b>Directory → Call History</b>	
<b>Delete</b>	Users can select an entry, then click "Delete" to remove it from the list.
<b>Delete All</b>	<p>Click on Delete All in order to remove all Call History stored in the phone.</p> <p><b>Note:</b> Users could use the drop-down list to show only selected call history type (All, Answered, Dialed, Missed, Transferred) and also use navigation keys to browse pages when many entries exist.</p>
<b>Directory → LDAP</b>	
<b>LDAP Protocol</b>	Configures the LDAP protocol to LDAP or LDAPS. LDAPS is a feature to support LDAP over TLS. The default setting is "LDAP".
<b>Server Address</b>	Configures the IP address or DNS name of the LDAP server.
<b>Port</b>	Configures the LDAP server port. The default port number is "389".
<b>Base</b>	<p>Configures the LDAP search base. This is the location in the directory where the search is requested to begin.</p> <p><u>Example:</u>          dc=grandstream, dc=com          ou=Boston, dc=grandstream, dc=com</p>



<b>User Name</b>	Configures the bind "Username" for querying LDAP servers. Some LDAP servers allow anonymous binds in which case the setting can be left blank.
<b>Password</b>	Configures the bind "Password" for querying LDAP servers. The field can be left blank if the LDAP server allows anonymous binds.
<b>LDAP Number Filter</b>	Configures the filter used for number lookups. <u>Examples:</u> ((telephoneNumber=%)(Mobile=%) returns all records which has the "telephoneNumber" or "Mobile" field starting with the entered prefix; (&(telephoneNumber=%) (cn=*)) returns all the records with the "telephoneNumber" field starting with the entered prefix and "cn" field set.
<b>LDAP Name Filter</b>	Configures the filter used for name lookups. <u>Examples:</u> ((cn=%)(sn=%)) returns all records which has the "cn" or "sn" field starting with the entered prefix; (!(sn=%)) returns all the records which do not have the "sn" field starting with the entered prefix; (&(cn=%) (telephoneNumber=*)) returns all the records with the "cn" field starting with the entered prefix and "telephoneNumber" field set.
<b>LDAP Version</b>	Selects the protocol version (Version 2 or Version 3) for the phone to send the bind requests. The default setting is "Version 3".
<b>LDAP Name Attributes</b>	Specifies the "name" attributes of each record which are returned in the LDAP search result. This field allows the users to configure multiple space separated name attributes. <u>Example:</u> gn cn sn description
<b>LDAP Number Attributes</b>	Specifies the "number" attributes of each record which are returned in the LDAP search result. This field allows the users to configure multiple space separated number attributes. <u>Example:</u> telephoneNumber telephoneNumber Mobile
<b>LDAP Display Name</b>	Configures the entry information to be shown on phone's LCD. Up to 3 fields can be displayed. <u>Example:</u> %cn %sn %telephoneNumber
<b>Max. Hits</b>	Specifies the maximum number of results to be returned by the LDAP server. If set to 0, server will return all search results. The default setting is 50.



<b>Search Timeout</b>	Specifies the interval (in seconds) for the server to process the request and client waits for server to return. The default setting is 30 seconds.
<b>Sort Results</b>	Specifies whether the searching result is sorted or not. Default setting is "No".
<b>LDAP Lookup</b>	Configures to enable LDAP number searching when dialing and receiving calls.
<b>Lookup Display Name</b>	Configures the display name when LDAP looks up the name for incoming call or outgoing call. This field must be a subset of the LDAP Name Attributes. <u>Example:</u> gn cn sn description



## BLF LED PATTERNS

Table 14: BLF LED Patterns

Pattern: Default		Pattern: Analog	
Call's state	Light Indication	Call's state	Light Indication
Offline	Off	Offline	Off
Idle	Solid Green	Idle	Solid Green
Trying	Solid Red	Trying	Solid Red
Talking	Solid Red	Talking	Solid Red
Proceeding	Flashing Red	Proceeding	Solid Red
Incoming call	Flashing Red	Incoming call	Flashing Red

Pattern: Directional		Mode: Inverse	
Call's state	Light Indication	Call's state	Light Indication
Offline	Off	Offline	Off
Idle	Solid Green	Idle	Solid Red
Trying	Flashing Green	Trying	Solid Green
Talking	Solid Red	Talking	Solid Green
Proceeding (Initiator)	Flashing Green	Proceeding	Flashing Green
Proceeding (Receiver)	Flashing Red	Incoming call	Flashing Green
Incoming call	Flashing Red		





Mode: Reserved (Red)		Mode: Reserved (Green)	
Call's state	Light Indication	Call's state	Light Indication
Offline	Off (Extension Board Icon: Off)	Offline	Off (Extension Board Icon: Off)
Idle	Off (Extension Board Icon: Idle)	Idle	Off (Extension Board Icon: Idle)
Trying	Solid Red	Trying	Solid Green
Talking	Solid Red	Talking	Solid Green
Proceeding	Solid Red	Proceeding	Solid Green
Incoming call	Flashing Red	Incoming call	Flashing Green



## NAT SETTINGS

If the devices are kept within a private network behind a firewall, we recommend using STUN Server. The following settings are useful in the STUN Server scenario:

- **STUN Server**

Under **Settings**→**General Settings**, enter a STUN Server IP (or FQDN) that you may have, or look up a free public STUN Server on the internet and enter it on this field. If using Public IP, keep this field blank.

- **Use Random Ports**

It is under **Settings**→**General Settings**. This setting depends on your network settings. When set to "Yes", it will force random generation of both the local SIP and RTP ports. This is usually necessary when multiple GRPs are behind the same NAT. If using a Public IP address, set this parameter to "No".

- **NAT Traversal**

It is under **Accounts X**→**Network Settings**. Default setting is "No". Enable the device to use NAT traversal when it is behind firewall on a private network. Select Keep-Alive, Auto, STUN (with STUN server path configured too) or other option according to the network setting.



## **BLUETOOTH (AVAILABLE ON GRP2614/GRP2615 & GRP2616 ONLY)**

Bluetooth is a proprietary, open wireless technology standard for exchanging data over short distances from fixed and mobile devices, creating personal area networks with high levels of security. GRP2614/GRP2615 & GRP2616 supports Bluetooth version 5. On the phone, users could connect to cellphones (supporting Bluetooth) via hands free mode or use Bluetooth headset for making calls.

To connect to a Bluetooth device, turn on phone's Bluetooth radio first. The first time when using a new Bluetooth device with the GRP2614/GRP2615 and GRP2616, "pair" the device with the phone so that both devices know how to connect securely to each other. After that, users could simply connect to a paired device. Turn off Bluetooth if it's not used.

Bluetooth related settings are under phone's LCD **Menu**→**System**→**Bluetooth**.

For more details on Bluetooth features, please refer to:

[http://www.grandstream.com/sites/default/files/Resources/GRP2600\\_Bluetooth\\_Guide.pdf](http://www.grandstream.com/sites/default/files/Resources/GRP2600_Bluetooth_Guide.pdf)



## PACKET CAPTURE

GRP26XX is embedded with packet capture function. The related options are under **Maintenance**→**Packet Capture**.

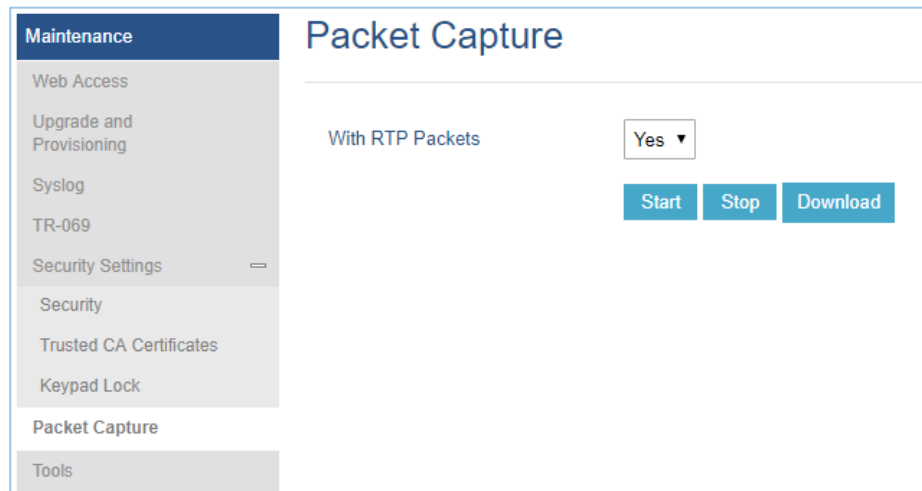

**Figure 5: Packet Capture in Idle**

User can also define whether RTP packets will be captured or not from **With RTP Packets** option. When the capture configuration is set, press **Start** button to start packet capture. The Status will become **RUNNING** while capturing, as showed in *Figure 6: Packet Capture when running*. Press **Stop** button to end capture.

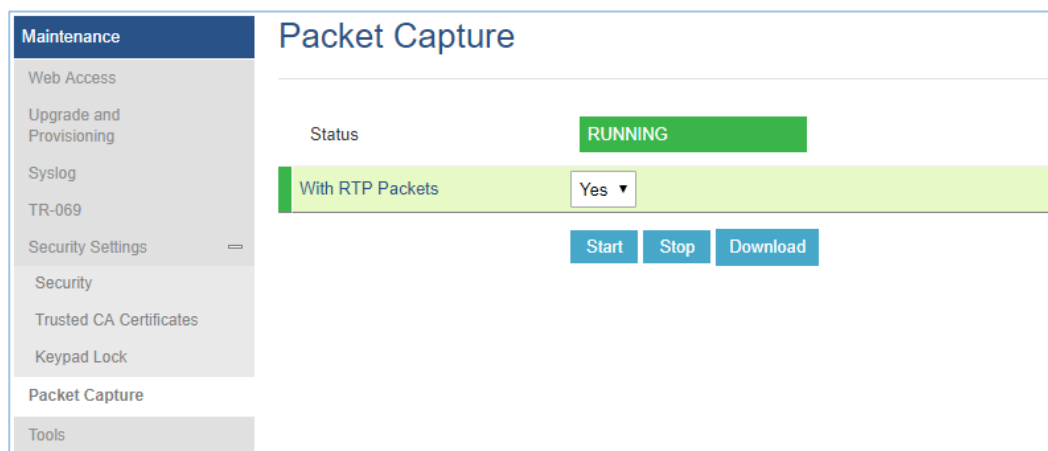

Press **Download** button to download capture file to local PC. The capture file is in .pcap format.



**Figure 6: Packet Capture when running**



## CLICK-TO-DIAL

From GRP26XX Web GUI, users could dial out with Click-to-Dial feature  on the top of the Web GUI. Before using the Click-To-Dial feature, make sure the option "Click-To-Dial Feature" under web GUI→Settings→Call Features is turned on. If no account registered, the icon will be in grey ; If click to dial is disabled, but account is registered, the icon will be in green, and clicking on the icon will do nothing.

When clicking on the  icon on the top menu of the Web GUI, a new dialing window will show for you to enter the number. Once Dial is clicked, the phone will go off hook and dial out the number from selected account. Please see [Figure 7: Click-to-Dial Feature]

Additionally, users could directly send the command for the phone to dial out by specifying the following URL in PC's web browser, or in the field as required in other call modules.

[http://ip\\_address/cgi-bin/api-make\\_call?phonenumber=1234&account=0&login=admin&password=admin](http://ip_address/cgi-bin/api-make_call?phonenumber=1234&account=0&login=admin&password=admin)

In the above link, replace the **fields** with

- **ip\_address**:  
Phone's IP Address.
- **phonenumber=1234**:  
The number for the phone to dial out
- **account=0**:  
The account index for the phone to make call. The index is 0 for account 1, 1 for account 2, 2 for account 3, and etc.
- **password=admin/123**:  
The admin login password or user login password of phone's Web GUI.

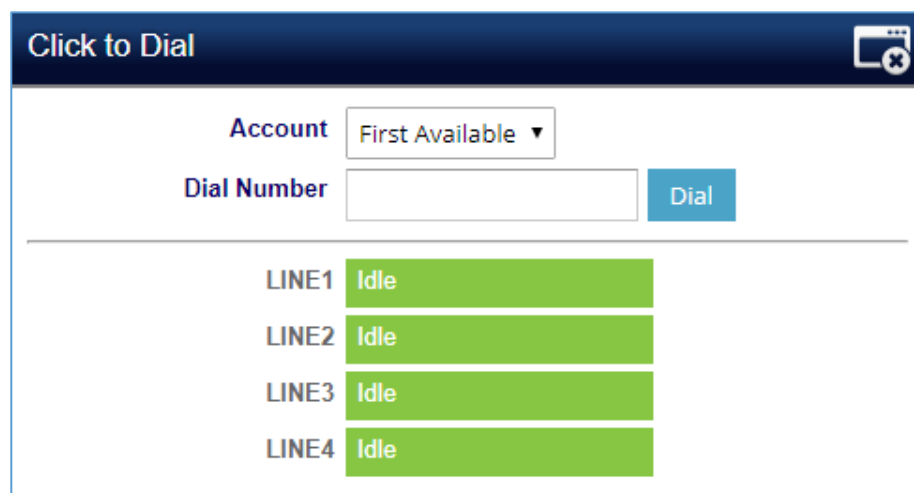

Figure 7: Click-to-Dial Feature

## OUTBOUND NOTIFICATION SUPPORT

Outbound notification options can be found under device web UI → **Settings** → **Outbound Notifications**. In the web UI, there are three sections under Outbound Notifications: “Action URL”, “Destination” and “Notification”.

- **Action URL**

To use Outbound Notification → Action URL, users need to know the supported events and the dynamic variables for the supported events. The dynamic variables for the supported events will be replaced by the actual values on the phone in order to notify the event to SIP server.

**Table 15: Action URL - Supported Events**

Supported Events	
Setup Completed	Terminated Call
Registered	Open DND
Unregistered	Close DND
Off Hook	Open Forward
On Hook	Close Forward
Incoming Call	Blind Transfer
Outgoing Call	Attended Transfer
Missed Call	Hold Call
Established Call	UnHold Call



**Settings**

- General Settings
- Broadsoft +
- External Service
- Call Features
- Multicast Paging
- Outbound Notification -
- Action URL**
- Destination
- Notification
- Preferences +
- Programmable Keys +
- Web Service
- XML Applications
- Voice Monitoring

## Action URL

Setup Completed	<input type="text"/>
Registered	<input type="text"/>
Unregistered	<input type="text"/>
Off Hook	<input type="text"/>
On Hook	<input type="text"/>
Incoming Call	<input type="text"/>
Outgoing Call	<input type="text"/>
Missed Call	<input type="text"/>
Established Call	<input type="text"/>
Terminated Call	<input type="text"/>
Open DND	<input type="text"/>
Close DND	<input type="text"/>
Open Forward	<input type="text"/>
Close Forward	<input type="text"/>
Blind Transfer	<input type="text"/>
Attended Transfer	<input type="text"/>
Hold Call	<input type="text"/>
UnHold Call	<input type="text"/>

**Figure 8: Action URL Settings Page**

**Table 16: Action URL - Supported Dynamic Variables**

Supported Dynamic Variables	
Dynamic Variable	Description
\$phone_ip	The IP address of the phone
\$mac	The MAC address of the phone
\$product	The product name of the phone
\$program_version	The software version of the phone
\$hardware_version	The hardware version of the phone
\$language	The display language of the phone
\$local	The called number on the phone
\$display_local	The display name of the called number on the phone
\$remote	The call number on the remote phone
\$display_remote	The display name of the call number on the remote phone
\$active_user	The account number during a call on the phone



After the user finishes setting Action URL on phone's web UI, when the specific phone event occurs on the phone, phone will send the Action URL to the specified SIP server. The dynamic variables in the Action URL will be replaced by the actual values.

Here is an example:

Configure the following Action URL on the phone's web UI → Settings → Outbound Notification → Action URL:

**Incoming Call:** `172.18.24.103/mac=$mac&local=$local`  
**Outgoing Call:** `172.18.24.103/remote=$remote&phone_ip=$phone_ip`  
**On hold:** `172.18.24.103/program_version=$program_version`

During incoming call, outgoing call and call hold, capture the trace on the phone and exam the packets. We can see the phone send Action URL with actual values to SIP server to notify phone events. In the following screenshot, from top to bottom, the phone events for each HTTP message are: Incoming Call, Outgoing Call, and On Hold in the format of the defined action URL with the parameters replaced with actual values.

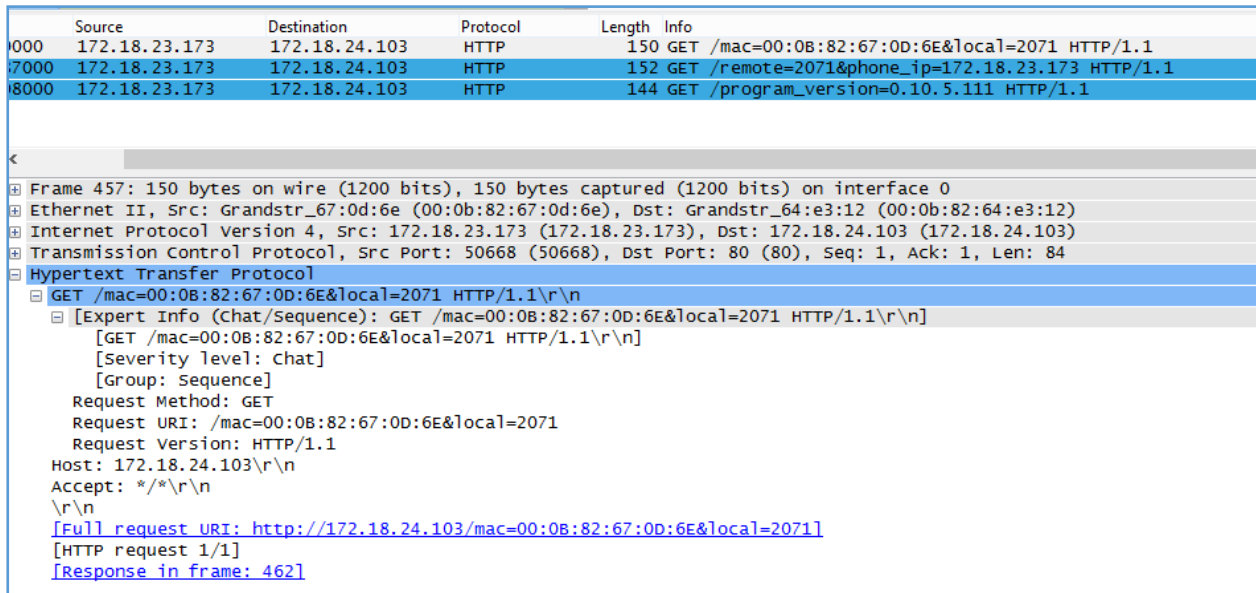

Figure 9: Action URL Packet

The P values listed in below table are for the options under phone web UI → Settings → Outbound Notification → Action URL.

Table 17: Action URL Parameters P-values

P Value	Web UI Option	Value Format
P8304	Setup Completed	String
P8305	Registered	
P8306	Unregistered	
P8308	Off Hook	
P8309	On Hook	
P8310	Incoming Call	
P8311	Outgoing Call	





P8312	Missed Call	
P8313	Established Call	
P8314	Terminated Call	
P8316	Open DND	
P8317	Close DND	
P8318	Open Forward	
P8319	Close Forward	
P8320	Blind Transfer	
P8321	Attended Transfer	
P8324	Hold Call	
P8325	UnHold Call	

- **Destination**

The options under phone's web UI→**Settings**→**Outbound Notification**→**Destination** configures the server information destination of the outbound notification. Click on “Add Destination” and users will see following window to configure destination server information.

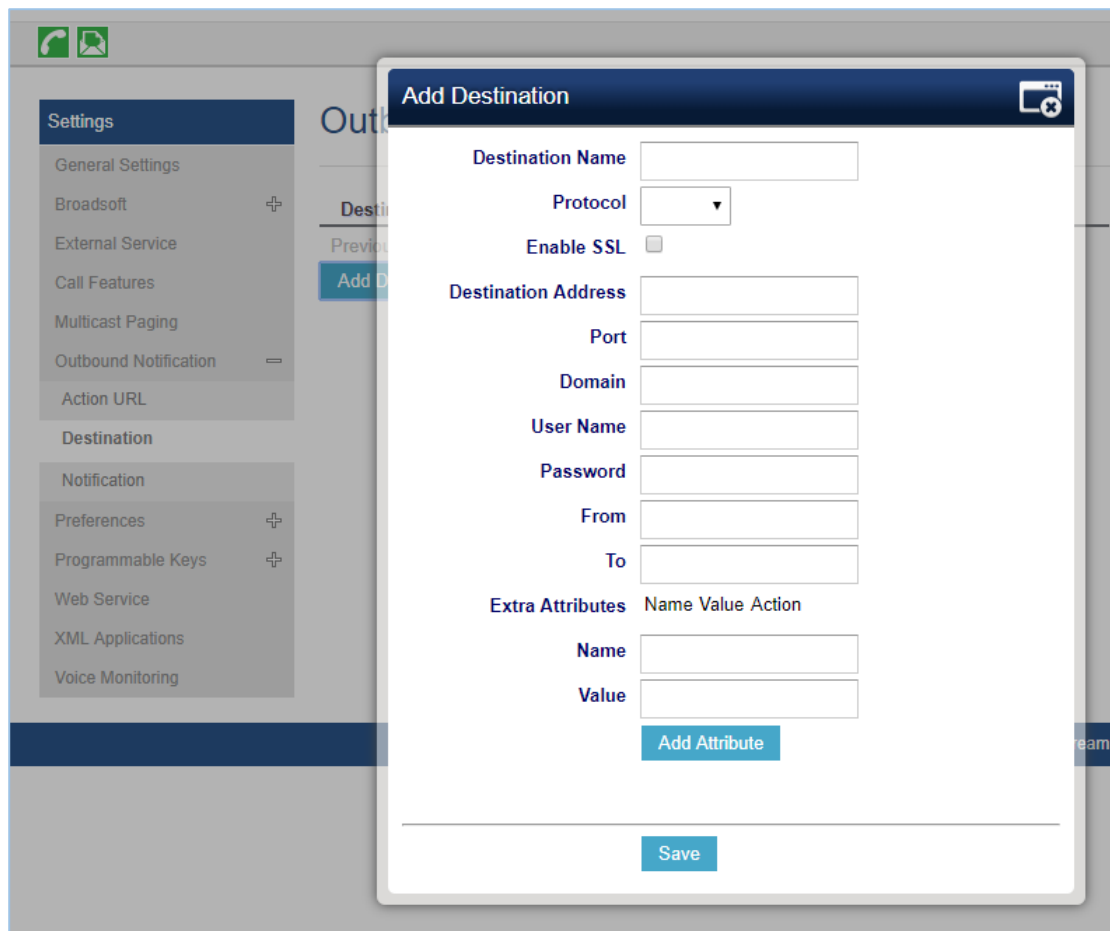

**Figure 10: Action URL - Add Destination**



The following table describes each option in the above interface.

**Table 18: Action URL – Add Destination Settings**

Destination Server Option	Description
<b>Destination Name</b>	Identify the destination name. It must be unique.
<b>Protocol</b>	Configure the protocol associated with the destination server. Currently XMPP and SMTP are supported.
<b>Enable SSL</b>	Configure whether to use SSL to encrypt for SMTP protocol. This option is not editable for XMPP.
<b>Destination Address</b>	Configure destination server address, e.g., talk.google.com.
<b>Port</b>	Configure destination server port, e.g., 5222.
<b>Domain</b>	Configure the destination server domain for XMPP protocol. This option is not editable for SMTP.
<b>User Name</b>	Configure the authorization user name of the destination server.
<b>Password</b>	Configure the authorization user password for the destination server.
<b>From</b>	Configure the sender name for SMTP protocol. This option is not editable for XMPP.
<b>To</b>	Configure the receiver's address.
<b>Extra Attribute Name</b>	Configure extra attribute's name reserved for protocol specific attributes such as "jid" for XMPP protocol. If "jid" is specified, user name and domain will be overridden.
<b>Extra Attribute Value</b>	Configure extra attribute's value reserved for protocol specific attributes such as "abc@gmail.com" for "jid" of XMPP protocol. If it's specified, user name and domain will be overridden.

Up to 10 destinations can be configured here. The P-values are listed in below table.

**Table 19: Action URL - Destination P-values**

P Value	Destination	Value Format
<b>P9910</b>	Destination 1	String. Each P value consists of all the options configured for this destination.  Example 1 - Destination 1 with protocol XMPP and 2 extra Attributes configured: P9910=serverName= <i>destination1</i> &protocol= <i>XMPP</i> &serverAddress= <i>talk.google.com</i> &port= <i>5222</i> &user= <i>username1</i> &password= <i>password1</i> &from=&to= <i>to1</i> &domain= <i>gmail.com</i> &extraAttrName1= <i>extraAttrValue1</i> &extraAttrName2= <i>extraAttrValue2</i>
<b>P9911</b>	Destination 2	
<b>P9912</b>	Destination 3	
<b>P9913</b>	Destination 4	
<b>P9914</b>	Destination 5	



<b>P9915</b>	Destination 6	<p>Example 2 - Destination 2 with protocol SMTP and 3 extra Attributes configured:</p> <p>P9911=serverName=<i>destination2</i>&amp;protocol=<i>SMTP</i>&amp;serverAddress=<i>smtps://smtp.gmail.com</i>&amp;port=<i>465</i>&amp;user=<i>username2</i>&amp;password=<i>password2</i>&amp;from=<i>username2</i>&amp;to=<i>to2</i>&amp;domain=<i>&amp;extraAttrName1=extraAttrValue1&amp;extraAttrName2=extraAttrValue2&amp;extraAttrName3=extraAttrValue3</i></p> <p>The <i>highlighted strings</i> in above examples are the actual values configured in each field for the destination.</p>
<b>P9916</b>	Destination 7	
<b>P9917</b>	Destination 8	
<b>P9918</b>	Destination 9	
<b>P9919</b>	Destination 10	

- **Notification**

After configuring destination server, users can configure notification information under phone's web UI→**Settings**→**Outbound Notification**→**Notification**. Click on “Add Notification” and users will see following window to configure notification.

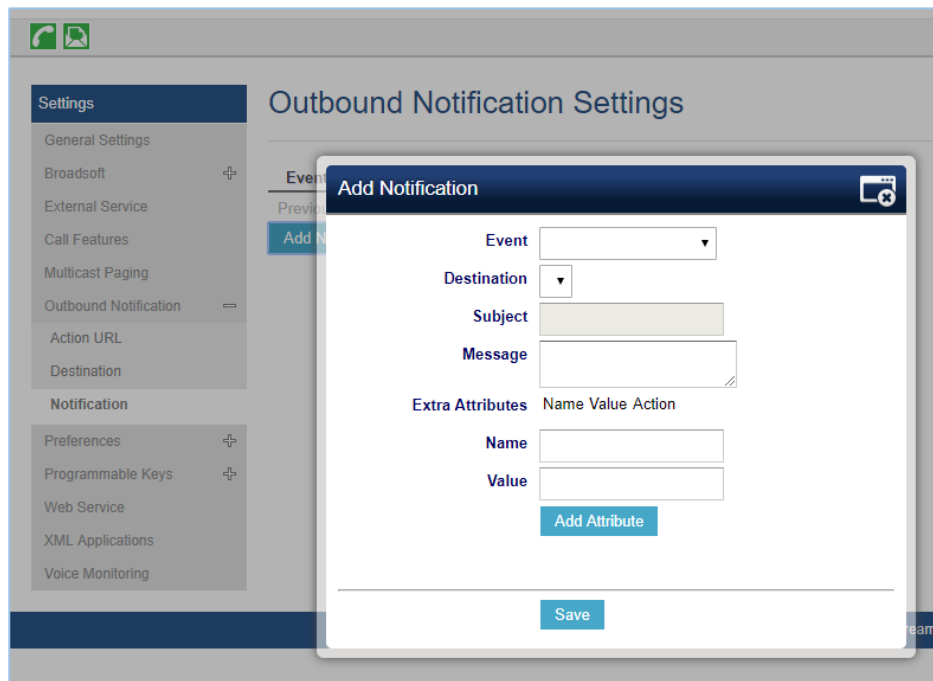

**Figure 11: Action URL - Add Notification**

**Table 20: Action URL – Notification Options**

<b>Notification Option</b>	<b>Description</b>
<b>Event</b>	Configures the event, which will trigger an outbound notification.
<b>Destination</b>	Configures the name of the destination where the outbound notification will be sent to.
<b>Subject</b>	Configures the subject of Email notification. This option is only applicable to SMTP protocol and it is not editable for other protocols.

<b>Message</b>	Configures the message body or the outbound notification.
<b>Extra Attribute Name</b>	Configure extra attribute's name reserved for specific attributes for a given notification in the future.
<b>Extra Attribute Value</b>	Configures extra attribute's value reserved for specific attributes for a given notification in the future.

The message body of the notification for each event can be customized with dynamic attributes embedded. The following table shows the mapping between event and dynamic attribute.

**Table 21: Action URL Notification – Events and Dynamic Attributes**

<b>Event</b>	<b>Dynamic Attribute Name</b>	<b>Dynamic Attribute Description</b>
<b>Call_Missed</b>	line	Line number associated with the call
	account	Account number associated with the call
	remoteNumber	The remote party number
	remoteName	The remote party name
	localNumber	The local party number
	localName	The local party name
	sipServer	The SIP server address of the account
	call-id	The SIP dialog call ID
	time	The time stamp when the missed call event occurs
<b>DND</b>	status	This is for DND status. The value can be “enabled” or “disabled”
<b>Call_Forward</b>	callType	This is for the type of the call. The value can be “incoming” or “outgoing”
	line	Line number associated with the call
	account	Account number associated with the call
	remoteNumber	The remote party number
	remoteName	The remote party name
	localNumber	The local party number
	localName	The local party name
	sipServer	The SIP server address of the account
	call-id	The SIP dialog call ID
	time	The timestamp when the call is forwarded
	fwNumber	Call Forward destination number
	fwReason	Call Forward reason
<b>OAM_Login</b>	OAMUser	OAM user name such as “admin”
	OAMLoginSource	OAM login source. The value can be “SSH” or “WebGUI”



	OAMLoginFromIP	OAM login From IP address. The value is the IP address of the PC who will log in phone's web UI or SSH
	OAMLoginCode	OAM login result code. The value can be "succeeded" or "failed"
	time	OAM login time stamp
<b>OAM_Lockout</b>	OAMUser	OAM user name such as "admin"
	OAMLoginSource	OAM login source. The value can be "SSH" or "WebGUI"
	OAMLoginFromIP	OAM login From IP address. The value is the IP address of the PC who will log in phone's web UI or SSH
	OAMLockoutCode	OAM lockout result code. The value can be "locked" or "unlocked"
	OAMLockoutTime	OAM lockout time stamp
<b>Incoming_Call</b>	callingNumber	Calling party number
	callType	Type of the call. The value can be "incoming" or "outgoing"
	line	Line number associated with the call
	account	Account number associated with the call
	remoteNumber	The remote party number
	remoteName	The remote party name
	localNumber	The local party number
	localName	The local party name
	sipServer	The SIP server address of the account
	call-id	The SIP dialog call ID
time	The time stamp when the incoming call event occurs	
<b>Outgoing_Call</b>	callType	Type of the call. The value can be "incoming" or "outgoing"
	line	Line number associated with the call
	account	Account number associated with the call
	remoteNumber	The remote party number
	remoteName	The remote party name
	localNumber	The local party number
	localName	The local party name
sipServer	The SIP server address of the account	



	time	The time stamp when the outgoing call event occurs
<b>Call_Established</b>	callType	Type of the call. The value can be “incoming” or “outgoing”
	line	Line number associated with the call
	account	Account number associated with the call
	remoteNumber	The remote party number
	remoteName	The remote party name
	localNumber	The local party number
	localName	The local party name
	sipServer	The SIP server address of the account
	call-id	The SIP dialog call ID
	startTime	The time stamp when outgoing call event occurs
	<b>Call_Terminated</b>	callType
line		Line number associated with the call
account		Account number associated with the call
remoteNumber		The remote party number
remoteName		The remote party name
localNumber		The local party number
localName		The local party name
sipServer		The SIP server address of the account
call-id		The SIP dialog call ID
startTime		The time stamp when the call is established
<b>Call_Forward_Status</b>	duration	The call duration
	account	The account number associated with the call forward status change
	forwardNumberAll	The forward number for Call Forward All
	forwardNumberBusy	The forward number for Call Forward Busy
	forwardNumberNoAns	The forward number for Call Forward No Answer
<b>Call Hold</b>	callType	Type of the call. The value can be “incoming” or “outgoing”
	line	Line number associated with the call
	account	Account number associated with the call
	remoteNumber	The remote party number
	remoteName	The remote party name
	localNumber	The local party number



	localName	The local party name
	sipServer	The SIP server address of the account
	call-id	The SIP dialog call ID
	startTime	The time stamp when the call is on hold
<b>Call_Resume</b>	callType	Type of the call. The value can be “incoming” or “outgoing”
	line	Line number associated with the call
	account	Account number associated with the call
	remoteNumber	The remote party number
	remoteName	The remote party name
	localNumber	The local party number
	localName	The local party name
	sipServer	The SIP server address of the account
	call-id	The SIP dialog call ID
	startTime	The time stamp when the call is resumed
<b>Blind_Transfer</b>	line	Line number associated with the call
	account	Account number associated with the call
	remoteNumber	The remote party number
	remoteName	The remote party name
	localNumber	The local party number
	localName	The local party name
	sipServer	The SIP server address of the account
	call-id	The SIP dialog call ID
	time	The time stamp when the call is transferred
	transferName	Transferred party name
	transferNumber	Transferred party number
<b>Attended_Transfer</b>	Line	Line number associated with the call
	account	Account number associated with the call
	remoteNumber	The remote party number
	remoteName	The remote party name
	localNumber	The local party number
	localName	The local party name
	sipServer	The SIP server address of the account
	call-id	The SIP dialog call ID
	Time	The time stamp when the call is transferred
	transferName	Transferred party name
	transferNumber	Transferred party number



<b>Register_Status</b>	registerStatus	Account register status. The value can be “registered” or “unregistered”
<b>Bootup_Complete</b>	N/A	N/A
<b>The dynamic attributes in this row are common attributes that can be applied to all events</b>	mac	MAC address of the phone
	phone_ip	IP address of the phone
	program_version	Software version of the phone
	hardware_version	Hardware version of the phone
	product	Product name of the phone
	language	Display language on the phone

All above dynamic attributes' value is generated by phone system and can be used as dynamic attributes with a pair of curved braces around them. For example, if the message body is specified as following:

*Your call from {remoteName}:{remoteNumber} to {localName}:{localNumber} was forwarded to {fwdNumber} by reason {fwdReason}.*

Then the message received in the outbound notification will look like this:

*Your call from Daniel:2070 to Jasmine:2071 was forwarded to 777777 by reason unconditional.*

Only attributes in curved braces will be replaced by the run time value. Other content will remain the same as static text.

For each event, at most 3 notifications can be configured. In total, up to 75 notifications can be configured. The P value for each notification is listed in below table.

**Table 22: Action URL Notification P-values**

P Value	Notification	Value Format
<b>P9920</b>	Notification 1	String. Each P value consists of all the options configured for this notification.
<b>P9921</b>	Notification 2	Example 1 – Notification 1 for event “Call_Missed” to destination 1, with 2 extra Attributes configured: P9920=eventName=Call_Missed&destName=destination1&subject=&msg=You have a missed call from {remoteName}:{remoteNumber} on Line {line}, account {account} at {time}.&extraAttrName1=extraAttrValue1&extraAttrName2=extraValue2
<b>P9922</b>	Notification 3	
<b>P9923</b>	Notification 4	
<b>P9924</b>	Notification 5	
<b>P9925</b>	Notification 6	
<b>P9926</b>	Notification 7	Example 2 – Notification 2 for event “Incoming_Call” to destination 2, with 2 extra Attributes configured: P9921=           eventName=Incoming_Call&destName=destination2&subject=Incoming Call Alert&msg=You have an {callType} call from
<b>P9927</b>	Notification 8	





<b>P9928</b>	Notification 9	<i>{remoteName}:{remoteNumber} on Line {line}, account {account} at</i>
<b>P9929</b>	Notification 10	<i>{time}.&amp;extraAttrName1=extraAttrValue1&amp;extraAttrName2=extraAttrValue2</i>
...	...	
<b>P9993</b>	Notification 73	The <i>highlighted strings</i> in above examples are the actual values configured in each field for the notification.
<b>P9994</b>	Notification 74	
<b>P9995</b>	Notification 75	



## UPGRADING AND PROVISIONING

### Unified Firmware

The GRP2612 / GRP2612P / GRP2612W / GRP2613 / GRP2614 / GRP2615 / GRP2616 support unified firmware for all GRP26XX models.

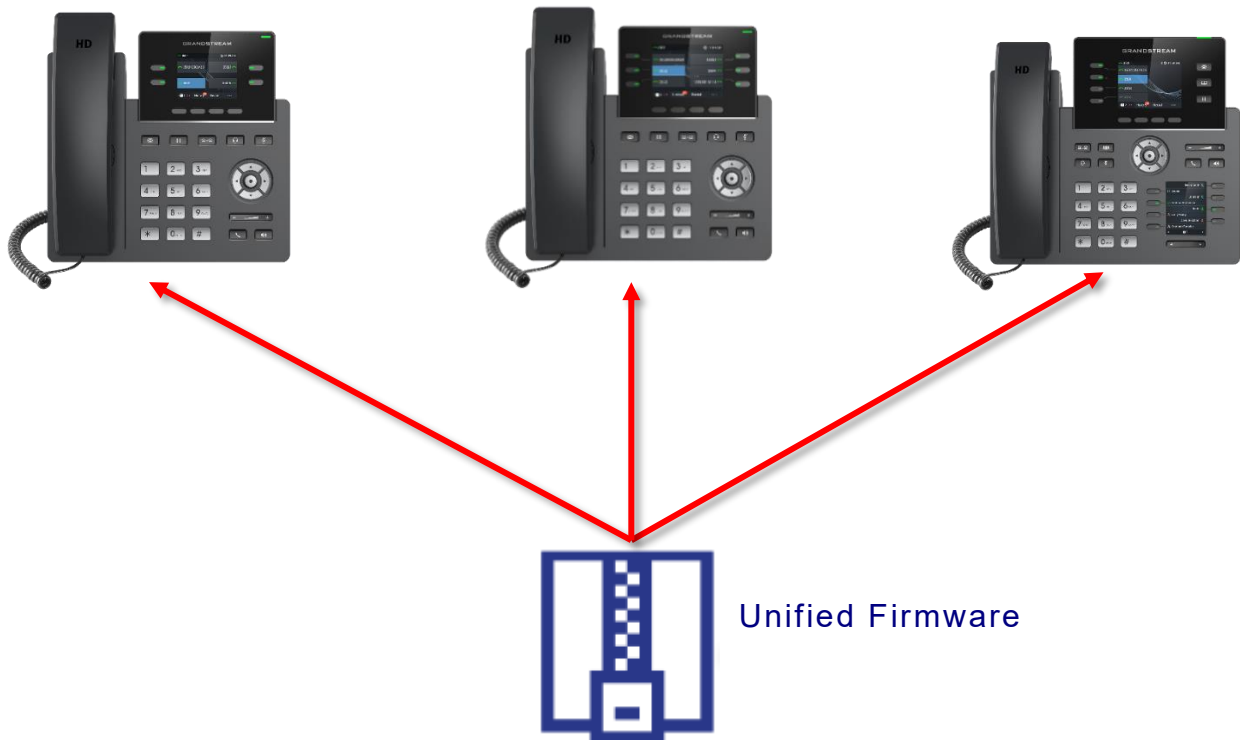

Figure 12: GRP26xx Unified Firmware

### Dual-image Firmware

The GRP2612 / GRP2612P / GRP2612W / GRP2613 / GRP2614 / GRP2615 / GRP2616 support dual-image firmware allowing to store two copies of firmware on flash to avoid bricked device on unsuccessful upgrade and down time.

The user can rollback to previously loaded firmware from phone's **Menu** → **System** → **Alternative Firmware**, and press "Rollback".

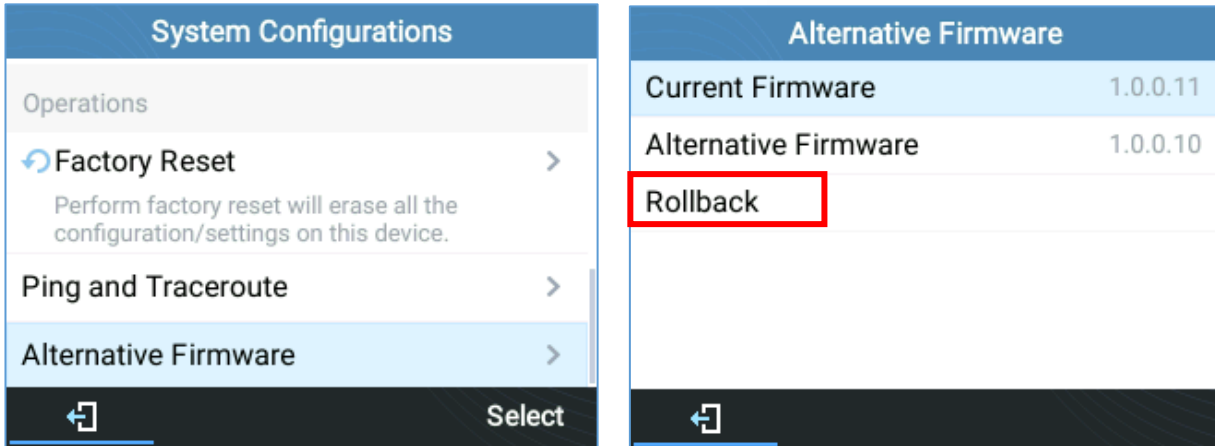

Figure 13: Alternative Firmware - Rollback

## Firmware Upgrade

The GRP2612 / GRP2612P / GRP2612W / GRP2613 / GRP2614 / GRP2615 / GRP2616 can be upgraded via TFTP / FTP / FTPS / HTTP / HTTPS by configuring the URL/IP Address for the TFTP / HTTP / HTTPS / FTP / FTPS server and selecting a download method. Configure a valid URL for TFTP, FTP/FTPS or HTTP/HTTPS, the server name can be FQDN or IP address.

### Examples of valid URLs:

[firmware.grandstream.com/BETA](http://firmware.grandstream.com/BETA)  
[fw.mycompany.com](http://fw.mycompany.com)

There are two ways to setup a software upgrade server: The LCD Keypad Menu or the Web Configuration Interface.

### Upgrade via Keypad Menu

Follow the steps below to configure the upgrade server path via phone's keypad menu:

1. Press MENU button and navigate using Up/Down arrow to select **System**.
2. In the System options, select **Upgrade**.
3. Enter the firmware server path and select upgrade method. The server path could be in IP address format or FQDN format.
4. Select **Start Provision** option and press the "Select" Softkey.
5. A warning window will be prompt for provision confirmation. Press "YES" Softkey to start upgrading/provisioning immediately.

When upgrading starts, the screen will show upgrading progress. When done you will see the phone restarts again. Please do not interrupt or power cycle the phone when the upgrading process is on.

### **Upgrade via Web GUI**

Open a web browser on PC and enter the IP address of the phone. Then, login with the administrator username and password. Go to Maintenance→Upgrade and Provisioning page, enter the IP address or the FQDN for the upgrade server in "Firmware Server Path" field and choose to upgrade via TFTP or HTTP/HTTPS or FTP/FTPS. Update the change by clicking the "Save and Apply" button. Then "Reboot" or power cycle the phone to update the new firmware.

When upgrading starts, the screen will show upgrading progress. When done you will see the phone restart again. Please do not interrupt or power cycle the phone when the upgrading process is on.

Firmware upgrading takes around 60 seconds in a controlled LAN or 5-10 minutes over the Internet. We recommend completing firmware upgrades in a controlled LAN environment whenever possible.

### **No Local TFTP/FTP/HTTP Servers**

For users that would like to use remote upgrading without a local TFTP/FTP/HTTP server, Grandstream offers a NAT-friendly HTTP server. This enables users to download the latest software upgrades for their phone via this server. Please refer to the webpage:

<http://www.grandstream.com/support/firmware>

Alternatively, users can download a free TFTP, FTP or HTTP server and conduct a local firmware upgrade. A free window version TFTP server is available for download from:

[http://www.solarwinds.com/products/freetools/free\\_tftp\\_server.aspx](http://www.solarwinds.com/products/freetools/free_tftp_server.aspx)

<http://tftpd32.jounin.net/>.

Instructions for local firmware upgrade via TFTP:

1. Unzip the firmware files and put all of them in the root directory of the TFTP server.
2. Connect the PC running the TFTP server and the phone to the same LAN segment.
3. Launch the TFTP server and go to the File menu→Configure→Security to change the TFTP server's default setting from "Receive Only" to "Transmit Only" for the firmware upgrade.
4. Start the TFTP server and configure the TFTP server in the phone's web configuration interface.
5. Configure the Firmware Server Path to the IP address of the PC.
6. Update the changes and reboot the phone.

End users can also choose to download a free HTTP server from <http://httpd.apache.org/> or use Microsoft IIS web server.



## Phone Provisioning

### Configuration File Download

Grandstream SIP Devices can be configured via the Web Interface as well as via a Configuration File (binary or XML) through TFTP, FTP/FTPS or HTTP/HTTPS. The "Config Server Path" is the TFTP, FTP/FTPS or HTTP/HTTPS server path for the configuration file.

It needs to be set to a valid URL, either in FQDN or IP address format. The "Config Server Path" can be the same or different from the "Firmware Server Path".

A configuration parameter is associated with each particular field in the web configuration page. A parameter consists of a Capital letter P and 2 to 5-digit numeric numbers. i.e., P2 is associated with the "New Password" in the Web GUI→**Maintenance**→**Web Access page**→**Admin Password**. For a detailed parameter list, please refer to the corresponding configuration template.

When the GRP2612 / GRP2612P / GRP2612W / GRP2613 / GRP2614 / GRP2615 / GRP2616 boots up or reboots, it will issue a request to download an XML file named "cfgxxxxxxxx.xml", where "xxxxxxxx" is the MAC address of the phone, i.e., "cfg000b820102ab" and "cfg000b820102ab.xml". If the download of "cfgxxxxxxxx.xml" file is not successful followed by a configuration file named "cfgxxxxxxxx", the phone will issue a request to download a specific model configuration file "cfg<model>.xml", where <model> is the phone model, i.e., "cfggrp2613.xml" for the GRP2613, "cfggrp2614" for the GRP2614. If this file is not available, the phone will issue a request to download the generic "cfg.xml" file. The configuration file name should be in lower case letters, If not found, the phone will request a file named "dev[MacAddress].cfg" where "MacAddress" is the MAC address of the device, With this provision file, users are able to provision the device with both Pvalues and aliases.

```
download https://fm.grandstream.com/gs/cfggrp2614.xml (No error)\n
download https://fm.grandstream.com/gs/cfg.xml (No error)\n
download https://fm.grandstream.com/gs/dev000b82f55284.cfg (No error)\n
download http://192.168.5.142/cfg000b82f55284.xml (No error)\n
download http://192.168.5.142/cfg000b82f55284 (No error)\n
download http://192.168.5.142/cfggrp2614.xml (No error)\n
download https://fm.grandstream.com/gs/cfg000b82f55284.xml (No error)\n
download https://fm.grandstream.com/gs/cfg000b82f55284 (No error)\n
download https://fm.grandstream.com/gs/cfggrp2614.xml (No error)\n
download https://fm.grandstream.com/gs/cfg.xml (No error)\n
download https://fm.grandstream.com/gs/dev000b82f55284.cfg (No error)\n
```

Figure 14: Config File Download



**Note: (Attempt to download Config File again)**

When doing provision on the phone, if your first config file contains p-values listed below, phone will try to download the potential second cfg.xml file and apply the second file without rebooting. Maximum 3 extra attempts.

Those P-values are:

- \*212 -- Config upgrade via
- \*234 -- Config prefix
- \*235 -- Config postfix
- \*237 -- Config upgrade Server
- \*240 -- Authenticate Config File
- \*1359 -- XML Config File Password
- \*8463 -- Validate Server Certificate
- \*8467 -- Download and process ALL Available Config Files
- \*20713 -- Always authenticate before challenge
- \*22011 -- Bypass Proxy For
- \*22030 -- Enable SSL host verification for provision

**Note: (P-values that trigger Auto-Provision)**

If the p-values listed below are changed while managing configuration on web UI or LCD, the provision process will be triggered:

- \* 192 -- Firmware upgrade server
- \* 232 -- Firmware prefix
- \* 233 -- Firmware postfix
- \* 6767 -- Firmware Upgrade Via
- \* 6768 -- Firmware HTTP/HTTPS Username
- \* 6769 -- Firmware HTTP/HTTPS Password
- \* 237 -- Config upgrade Server
- \* 212 -- Config upgrade via
- \* 234 -- Config prefix
- \* 235 -- Config postfix
- \* 1360 -- Config HTTP/HTTPS username
- \* 1361 -- Config HTTP/HTTPS password.

**Note: Certificates and Keys provisioning**

Users can configure the phone to get all the needed certificates during boot up. Instead of putting the certificate/key content in text directly from the Web interface or uploading them manually, they can choose to provision them from the configuration file by putting the URL in the Pvalue field of each certificate and/or key. (e.g. [http://ProvisionServer\\_address/SIP-TLS-Certificate.pem](http://ProvisionServer_address/SIP-TLS-Certificate.pem)) The phone will then process the URL, search for the appropriate certificate/Key file, download it and then apply it into the phone.



```
HTTP GET /SIP-TLS-Private-Key.key HTTP/1.1
HTTP HTTP/1.1 200 OK (application/octet-stream)
HTTP GET /SIP-TLS-Certificate.pem HTTP/1.1
HTTP HTTP/1.1 200 OK (application/octet-stream)
HTTP GET /Trusted-certificate-1.crt HTTP/1.1
HTTP HTTP/1.1 200 OK (application/octet-stream)
HTTP GET /Trusted-certificate-2.crt HTTP/1.1
HTTP HTTP/1.1 200 OK (application/octet-stream)
HTTP GET /Trusted-certificate-3.crt HTTP/1.1
HTTP HTTP/1.1 200 OK (application/octet-stream)
HTTP GET /Trusted-certificate-4.crt HTTP/1.1
HTTP HTTP/1.1 200 OK (application/octet-stream)
HTTP GET /Trusted-certificate-5.crt HTTP/1.1
HTTP HTTP/1.1 200 OK (application/octet-stream)
HTTP GET /Trusted-certificate-6.crt HTTP/1.1
HTTP HTTP/1.1 200 OK (application/octet-stream)
HTTP GET /OpenVPN-CA.crt HTTP/1.1
HTTP HTTP/1.1 200 OK (application/octet-stream)
HTTP GET /OpenVPN-Certificate.pem HTTP/1.1
HTTP HTTP/1.1 200 OK (application/octet-stream)
HTTP GET /OpenVPN-Key.key HTTP/1.1
HTTP HTTP/1.1 200 OK (application/octet-stream)
```

**Figure 15: Certificates Files Download**

For more details on XML provisioning, please refer to:

[http://www.grandstream.com/sites/default/files/Resources/gs\\_provisioning\\_guide.pdf](http://www.grandstream.com/sites/default/files/Resources/gs_provisioning_guide.pdf)

## No Touch Provisioning

After the phone sends, config file request to the Broadsoft provisioning server via HTTP/HTTPS, if the provisioning server responds “401 Unauthorized” asking for authentication, the phone’s LCD will prompt a window for user to enter username and password. Once correct username and password are entered, the phone will send config file request again with authentication. Then the phone will receive the config file to download and get provisioned automatically.

Besides manually entering the username and password in LCD prompt, users can save the login credentials for provisioning process as well. The username and password configuration is under phone’s web UI→**Maintenance**→**Upgrade and provisioning** page: “HTTP/HTTPS Username” and “HTTP/HTTPS Password”. If the saved username and password saved are correct, login window will be skipped. Otherwise, login window will be popped up to prompt users to enter correct username and password again.

## Shortcut of Upgrade and Provision via Keypad Menu

When GRP phone is in idle state, user could press HOLD key and RIGHT navigation key together to trigger provision functions. Similarly, phone will pop up reboot banner while idle, if user presses HOLD key and LEFT navigation key together. After the provision or reboot banner pops up on LCD screen, user could press YES/NO Softkey to confirm/cancel the action.



## GRP26XX TOOLS

From the web GUI under Maintenance → Tools, 4 tools are provided:

**Provision:** Makes the phone trigger an instant provisioning.

**Factory reset:** Sets back the phone to the factory default settings.

---

 **Warning:**

Restoring the Factory Default Settings will delete all configuration information on the phone. Please backup or print all the settings before you restore to the factory default settings. Grandstream is not responsible for restoring lost parameters and cannot connect your device to your VoIP service provider.

---

**Ping:** Makes the phone ping an URL to check if it has access to it.

**Traceroute:** Checks the route packets take to the specified URL.

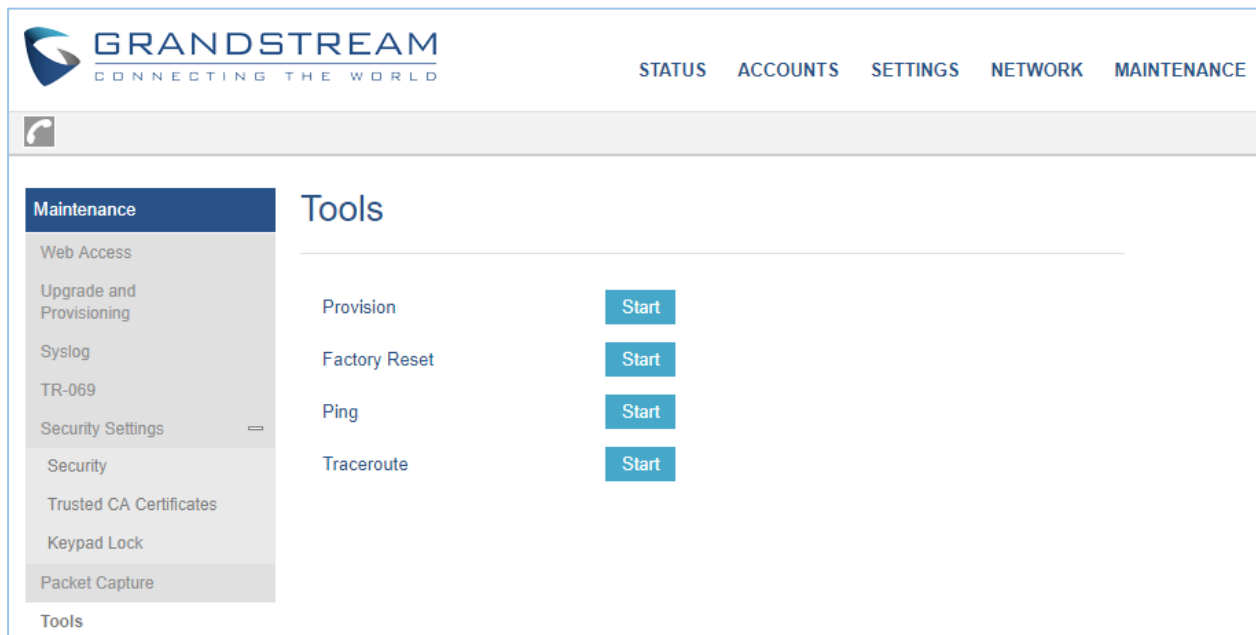

Figure 16: GRP26XX Tools



## RESTORE FACTORY DEFAULT SETTING

---

 **Warning:**

Restoring the Factory Default Settings will delete all configuration information on the phone. Please backup or print all the settings before you restore to the factory default settings. Grandstream is not responsible for restoring lost parameters and cannot connect your device to your VoIP service provider.

---

### Restore Factory settings using LCD Menu

Please follow the instructions below to reset the phone:

1. Press MENU button to bring up the keypad configuration menu.
2. Select "System" and enter.
3. Select "Operations → Factory Reset".
4. A warning window will pop out to make sure a reset is requested and confirmed.

Press the "Yes" Softkey to confirm and the phone will reboot, or "No" Softkey to cancel the Reset.

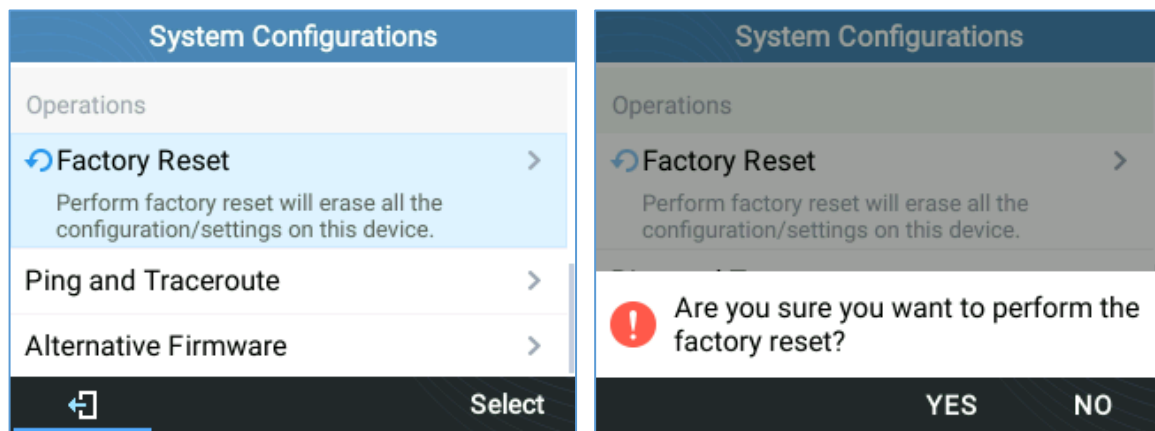

Figure 17: Factory Reset using LCD Menu

## EXPERIENCING GRP26XX

Please visit our website: <http://www.grandstream.com> to receive the most up- to-date updates on firmware releases, additional features, FAQs, documentation and news on new products.

We encourage you to browse our [product related documentation](#), [FAQs](#) and [User and Developer Forum](#) for answers to your general questions. If you have purchased our products through a Grandstream Certified Partner or Reseller, please contact them directly for immediate support.

Our technical support staff is trained and ready to answer all of your questions. Contact a technical support member or [submit a trouble ticket online](#) to receive in-depth support.

Thank you again for purchasing Grandstream IP phone, it will be sure to bring convenience and color to both your business and personal life.

