

# DECT Comfort call



## Setup Guide

DW Series  
Setup Guide

# Contents "Setup Guide"

- Important safety information ..... 2**
- Scope of delivery and overview of the DW series ..... 3**
  - Base stations with components ..... 3
  - Headsets with components ..... 4
- Product overview of the base stations ..... 5**
  - Overview of the front ..... 5
  - Overview of the rear ..... 5
- Setting up the base station ..... 6**
  - Connecting the base station to the mains power supply ..... 6
  - Connecting the base station to a fixed line phone ..... 7
  - Connecting the base station to an optional  
electronic hook switch control (EHS) ..... 9
  - Connecting the base station to a computer ..... 10
  - Securing the connected cables ..... 10
- Charging the headset ..... 11**
- Testing the headset system and the sound quality ..... 13**
  - Adjusting the headset system using the DIP switches ..... 13
  - Adjusting the audio signal by means of the dial tone ..... 15
  - Adjusting the volume ..... 16
  - Adjusting the automatic audio transmission "Auto Audio" ..... 16
- If a problem occurs ..... 17**
- Specifications ..... 18**



## Important safety information

- ▶ Please read this instruction manual carefully and completely before using the product.
- ▶ Always include this instruction manual when passing the product on to third parties.
- ▶ Do not use an obviously defective product.

### Preventing damage to health and accidents

- ▶ Do not listen at high volume levels for long periods of time to prevent hearing damage.
- ▶ Always maintain a distance of at least 3.94" (10 cm) between the ear cups and the cardiac pacemaker or implanted defibrillator since the product generates permanent magnetic fields.
- ▶ Keep the product, accessories and packaging parts out of reach of children and pets to prevent accidents and choking hazards.
- ▶ Do not use the product in situations which require special attention.

### Preventing damage to the product and malfunctions

- ▶ Always keep the product dry and do not expose it to extreme temperatures (hairdryer, heater, extended exposure to sunlight, etc.) to avoid corrosion or deformation.
- ▶ Only use attachments/accessories supplied or recommended by Sennheiser.
- ▶ Only clean the product with a soft, dry cloth.
- ▶ Unplug the power supply unit from the wall socket to completely disconnect the product from the mains power supply.
- ▶ Do not short-circuit the contacts of the product. Make sure that no metal objects (e.g. paper clips, hair pins, earrings) come into contact with the interfaces and contacts.
- ▶ Only use the base station for charging DW series headsets.

### Intended use/Liability

The headset system can be used for calling and – together with a computer (VoIP) and/or a telephone – for audio input/output and is intended for professional office or call center use.

It is considered improper use when this product is used for any application not named in this instruction manual.

Sennheiser does not accept liability for damage arising from abuse or misuse of this product and its attachments/accessories. The risk is to be borne by the user.

Sennheiser is not liable for damages to USB devices that are not consistent with the USB specifications.

Sennheiser is not liable for damages resulting from the loss of connection due to flat or overaged rechargeable batteries or exceeding the DECT transmission range.

# Scope of delivery and overview of the DW series



The DW series allows you to combine base stations (BS) and headsets (HS) to meet your needs. The listed headsets and base stations are compatible with each other. The DW series base stations marked with ML in their name are optimized for Microsoft® Lync™.

The scope of delivery includes – depending on the product purchased – a base station and/or a headset with corresponding components.

## Base stations with components

- DW BS for fixed line phone and computer
- DW BS ML for fixed line phone and computer, optimized for Microsoft Lync
- DW BS USB for computer
- DW BS USB ML for computer, optimized for Microsoft Lync
- DW BS Phone for fixed line phone

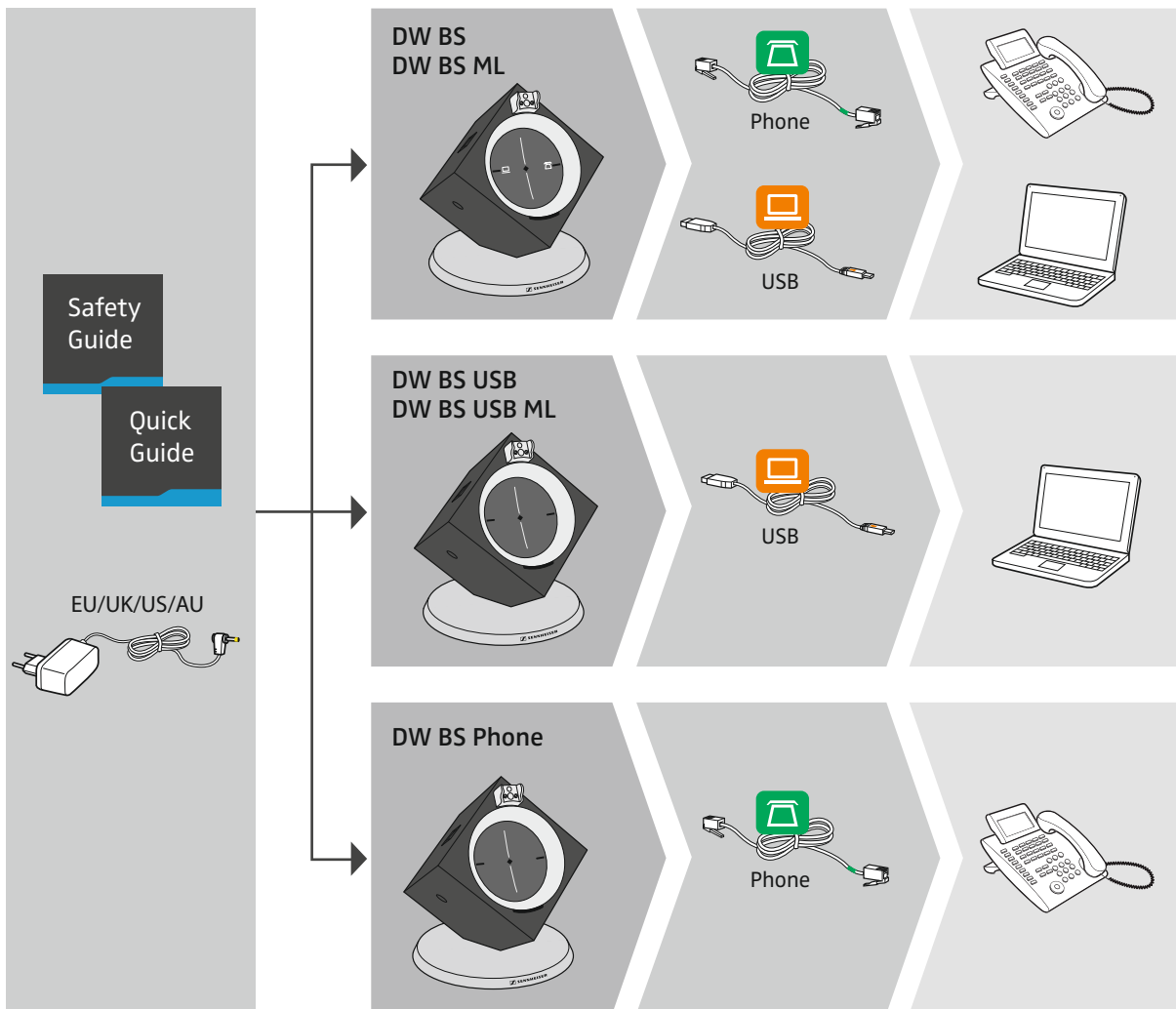

### Headsets with components

DW Office – HS monaural, with different wearing styles

DW Pro1 – HS monaural, with headband

DW Pro2 – HS binaural, with headband

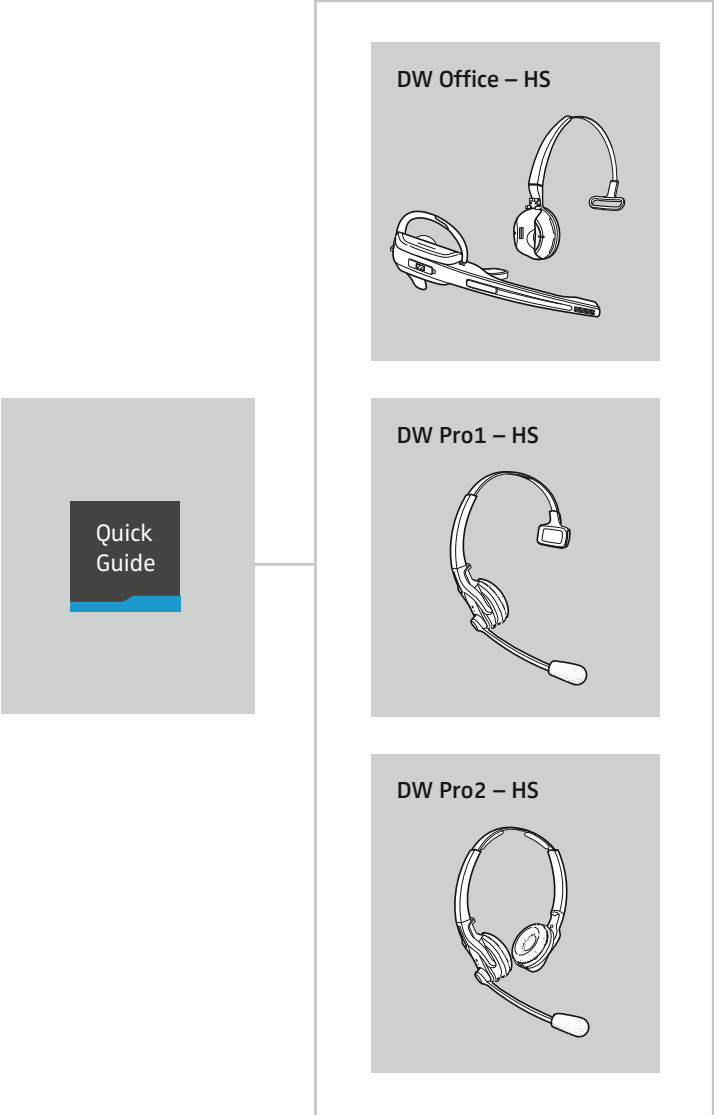

# Product overview of the base stations

## Overview of the front

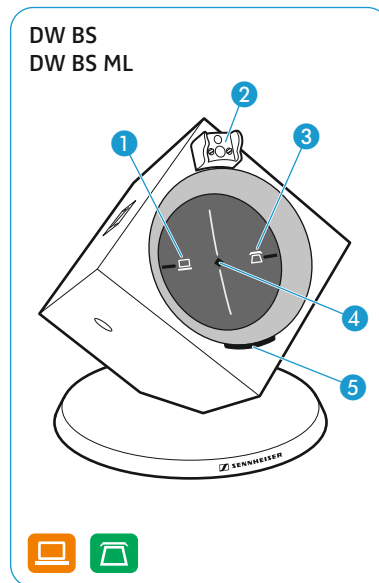

- 1 PC button with LED
- 2 Charging contacts
- 3 Phone button with LED

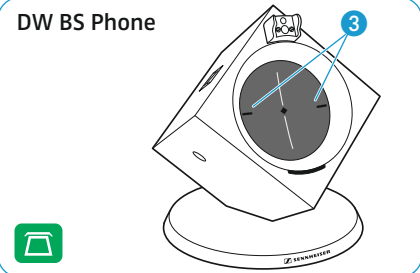
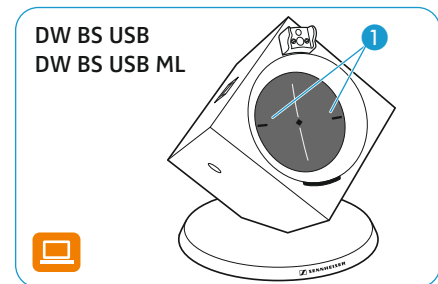

- 4 Link LED ◇
- 5 Charge status LED

## Overview of the rear

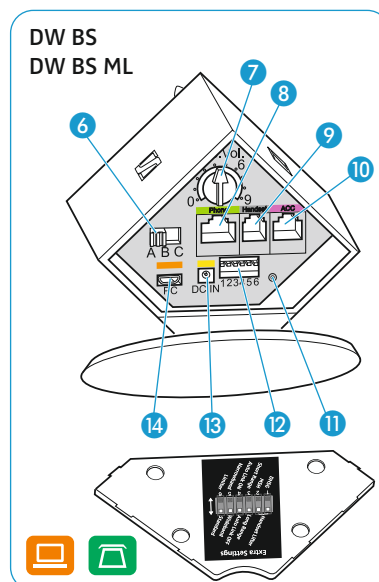

- 6 ABC switch
- 7 Microphone volume control
- 8 Phone socket
- 9 Handset socket

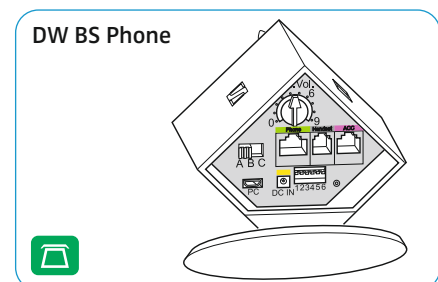
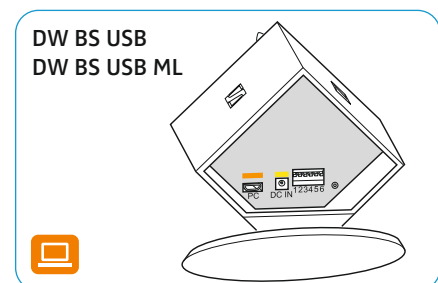

- 10 ACC socket
- 11 Set button
- 12 DIP switch row 1 to 6
- 13 DC IN socket
- 14 PC socket (USB)

## Setting up the base station

You can use the headset system with your fixed line phone and/or your computer. The base station controls the wireless communication to the headsets.

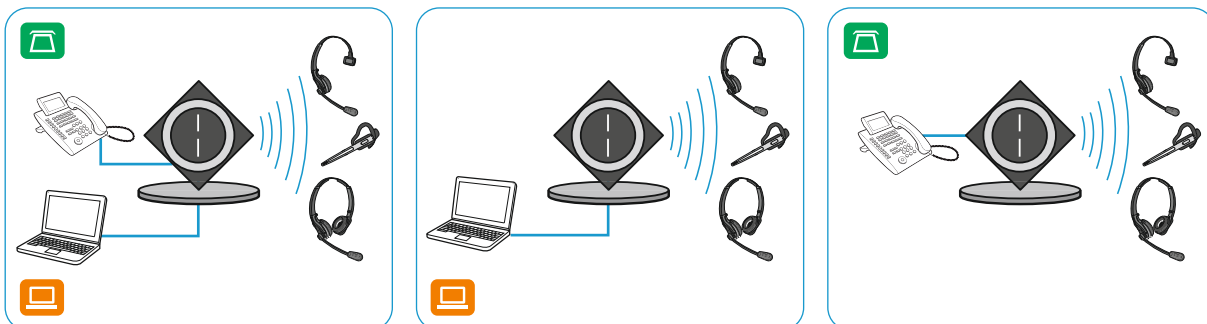

- ▶ Place the base station at a minimum distance of 15 cm from the fixed line phone.

### Connecting the base station to the mains power supply

- 1 Remove the cover.
- 2 Connect the connector of the power supply unit to the **DC IN** socket (marked yellow). Connect the power supply unit to a wall socket.
- 3 The Link LED  $\diamond$  lights up red.

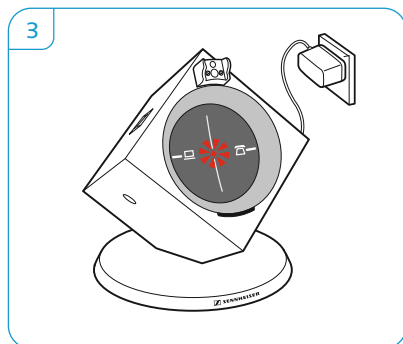
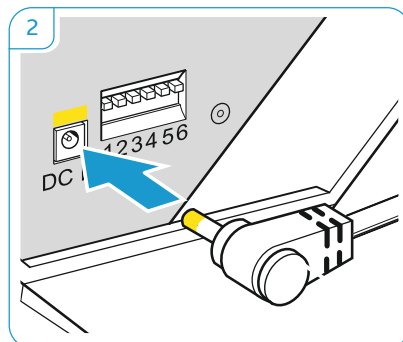
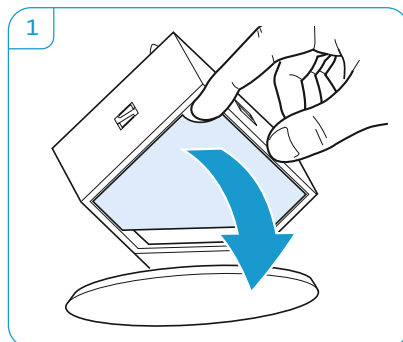

### Disconnecting the base station from the mains power supply

- ▶ If the product is not used for extended periods of time, unplug the power supply unit from the wall socket.

## Connecting the base station to a fixed line phone



Connection possibilities		Page
A	Connection to a fixed line phone without headset socket	7
B	Connection to a fixed line phone with headset socket	8
C	Connection to an optional mechanical handset lifter	8

- ▶ Check which connection possibility is best suited for your telephone.
- ▶ Follow the instructions in the corresponding chapter.

### A Connecting the base station to a fixed line phone without headset socket

- 1 Disconnect the handset cable from the telephone and connect it to the **Handset** socket (marked gray) on the base station.
- 2 Connect the telephone cable to the handset socket on the telephone and to the **Phone** socket (marked green) on the base station.
- 3 Use a pointed object (e.g. a ball pen) to set the DIP switches 1 and 2 to the position shown.

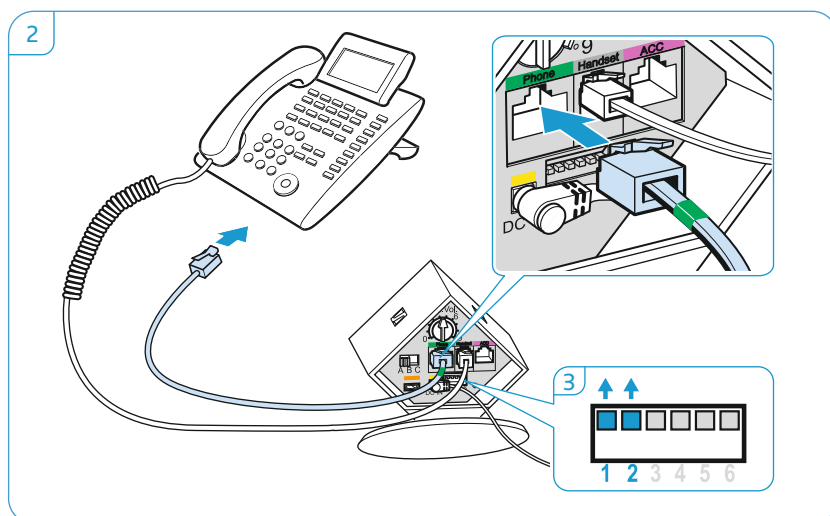
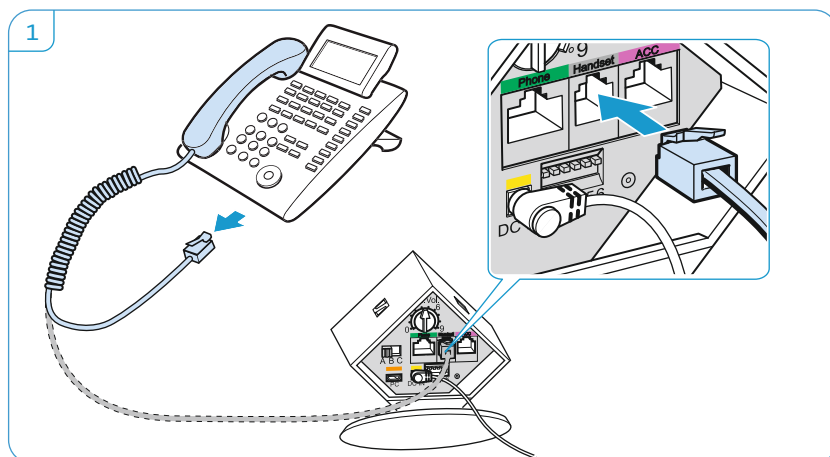



**B** Connecting the base station to a fixed line phone with headset socket

- 1 Connect the telephone cable to the headset socket on the telephone and to the **Phone** socket (marked green) on the base station.
- 2 Use a pointed object (e.g. a ball pen) to set the DIP switches 1 and 2 to the position shown.

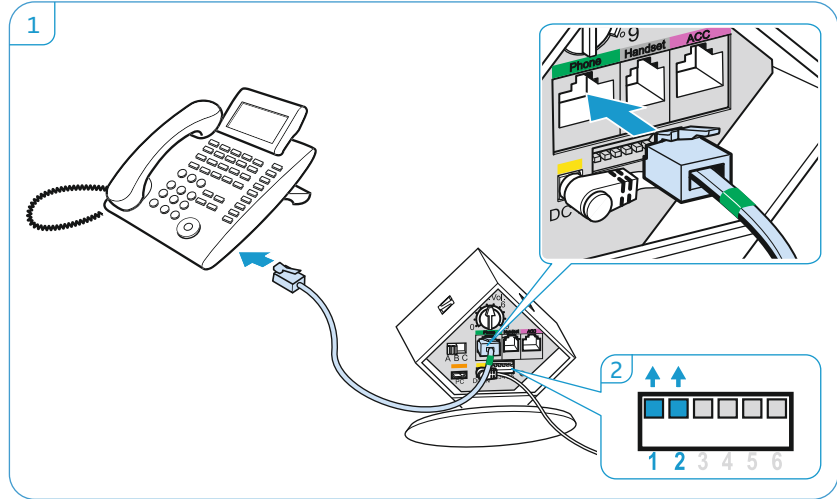

**C** Connecting the base station to an optional mechanical handset lifter

The Sennheiser HSL 10 II mechanical handset lifter is an optional accessory available from your Sennheiser partner. The handset lifter allows you to answer calls even when you are away from your desk.

- ▶ Connect the base station to the fixed line phone as described in chapter **A**.
- ▶ Connect the handset lifter to the **ACC** socket on the base station.
- ▶ Connect the handset lifter to the fixed line phone. For more information, refer to the instruction manual of the HSL 10 II handset lifter.

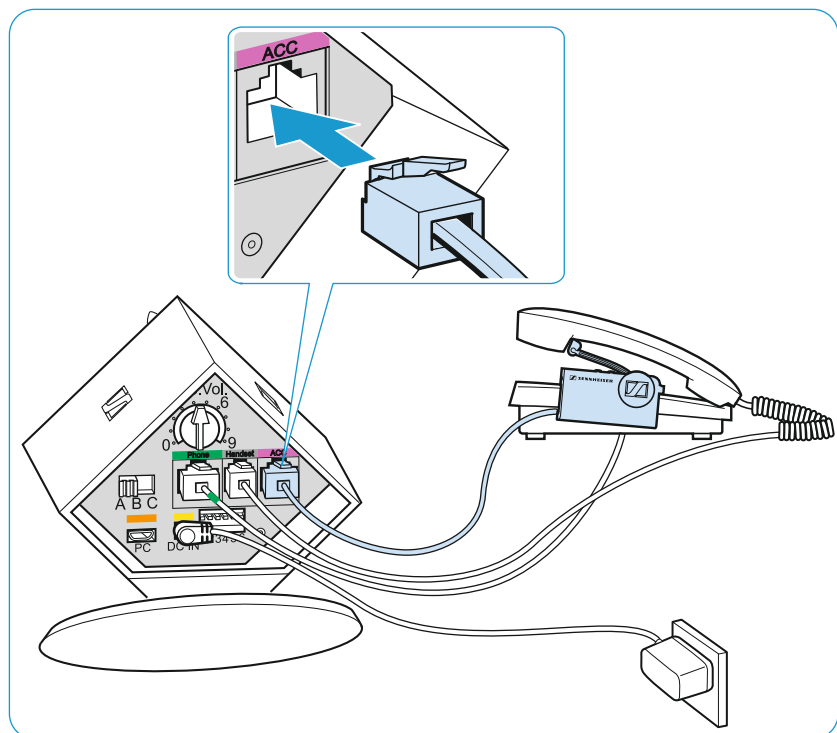

## Connecting the base station to an optional electronic hook switch control (EHS)



The necessary EHS connection cables as well as adapter cables for manufacturer specific standards are available as optional accessories from your Sennheiser partner. The corresponding quick guides are supplied with the cables or can be found on the product page on our website at [www.sennheiser.com](http://www.sennheiser.com).

By way of example of a Siemens and an Alcatel adapter cable, the following describes how to connect the base station to an electronic hook switch.

- 1 Connect the base station to the fixed line phone.
- 2 Use a pointed object (e.g. a ball pen) to set the DIP switch to the position shown.

### Siemens, Agfeo, Aastra, Auerswald, etc.

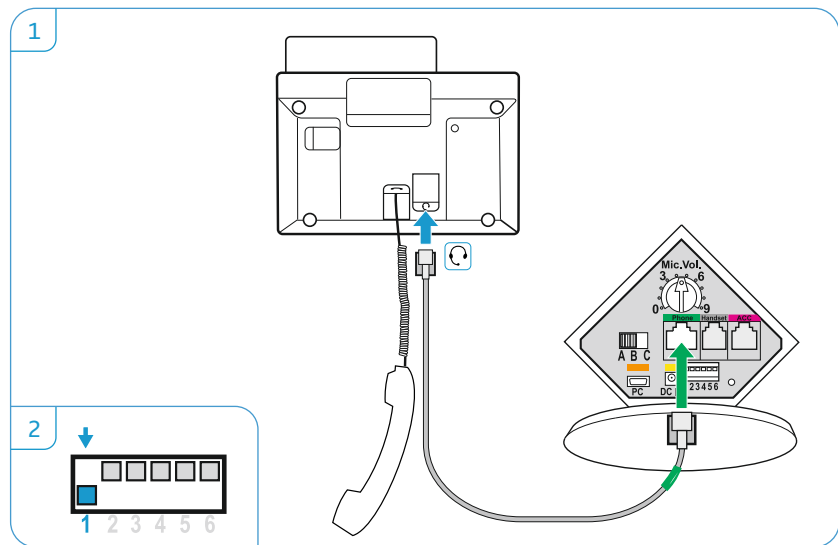

### Alcatel

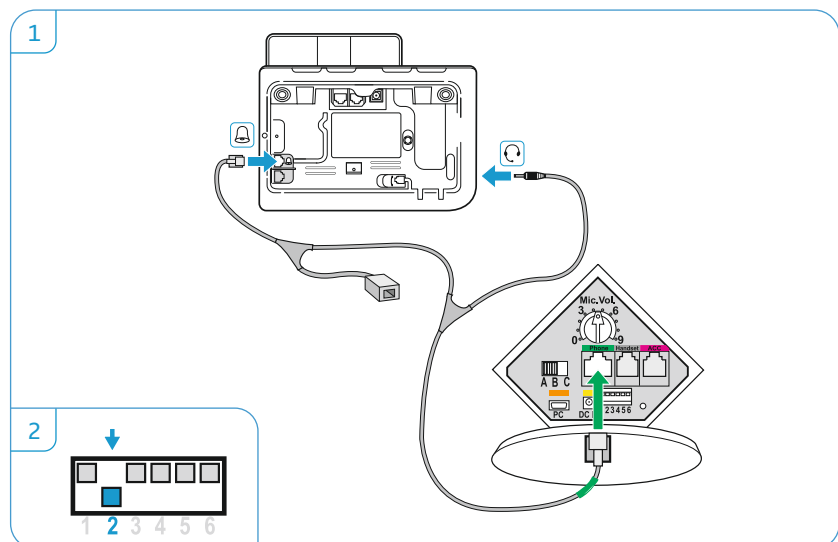

**i** For an overview of the available connection and adapter cables, visit the DW series product page on our website at [www.sennheiser.com](http://www.sennheiser.com) or contact your Sennheiser partner.

## Connecting the base station to a computer



- ▶ Connect the USB cable to the **PC** socket (marked orange) on the base station and to a USB socket of your computer. The operating system detects the USB audio device "Sennheiser DECT" and installs the necessary drivers.

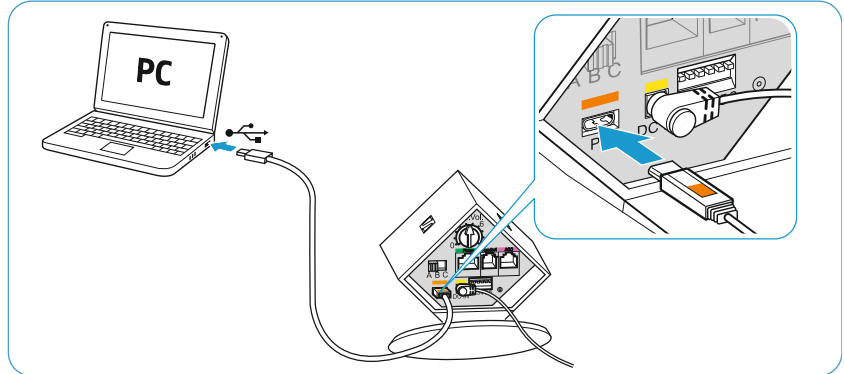

### Sennheiser PC software



The free Sennheiser PC software allows you to add value to your Sennheiser products. The Sennheiser Updater, for example, facilitates easy updating of products with new software. For more information, visit our website at [www.sennheiser.com/cco/software](http://www.sennheiser.com/cco/software).

## Securing the connected cables

- 1 Replace the cover to the rear of the base station.
- 2 Tilt the cover upwards until it locks into place with an audible click.

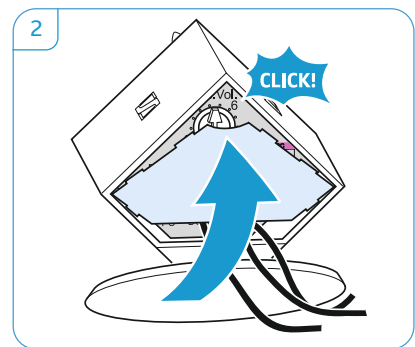
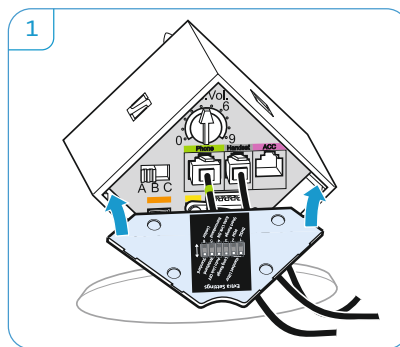

## Charging the headset



Charge the rechargeable battery for at least 20 minutes without interruption before using it for the first time. A complete charging process takes about 60 minutes.

### Charging the headset in the base station

- ▶ Place the headset into the magnetic holder of the base station. The Headset LED lights up blue and the rechargeable battery is being charged. The Charge status LED on the base station indicates the charge status.

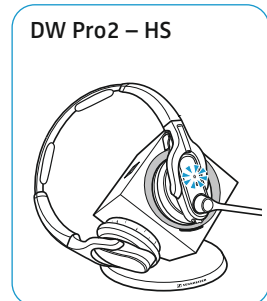
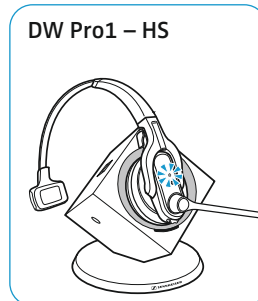
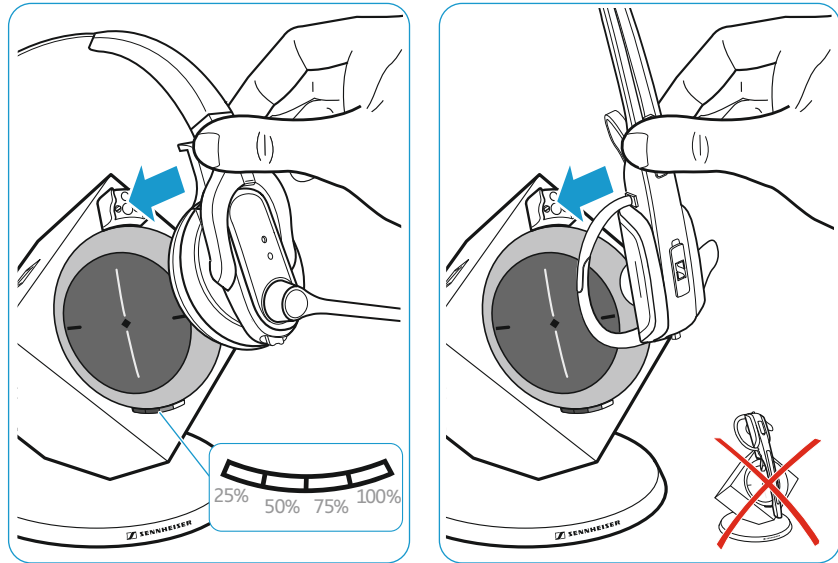

During the first charging process, it may take up to 5 minutes until the Headset LED lights up blue.

LED segment (white = lit up)	Required charging time	Corresponds to a talk time of	
		Wideband	Narrowband
	approx. 10 min.	approx. 2 hrs	approx. 3 hrs
	approx. 20 min.	approx. 4 hrs	approx. 6 hrs
	approx. 40 min.	approx. 6 hrs	approx. 9 hrs
	approx. 60 min.	approx. 8 hrs	approx. 12 hrs

- ☛ If the headset is outside the range of the base station, it will switch off after 30 minutes in order to conserve battery power.

### Charging the headset using the optional CH 10 headset charger

The Sennheiser CH 10 headset charger is an optional accessory available from your Sennheiser partner. The CH 10 allows you to charge additional DW series headsets.

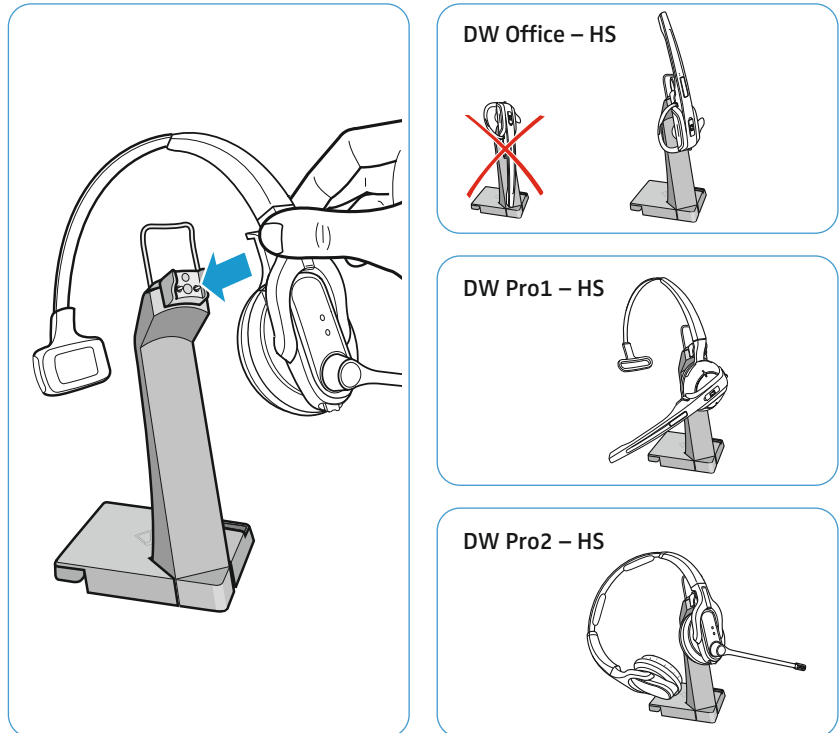

► Refer to the instruction manual of the CH 10 for more information.

### Charging several headsets simultaneously

The MCH 7 multi USB power source is an optional accessory available from your Sennheiser partner. Together with the CH 10 USB, the MCH 7 allows you to charge up to 7 headsets simultaneously.

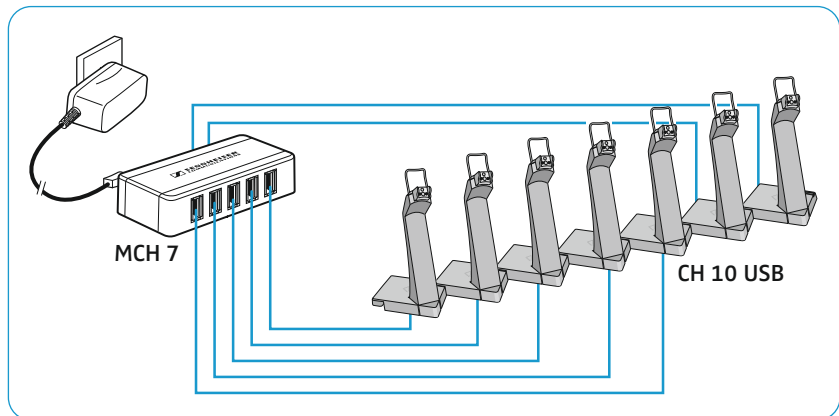

► Refer to the instruction manual of the MCH 7 for more information.

# Testing the headset system and the sound quality

## Adjusting the headset system using the DIP switches



- 1 Press the Link button on the headset to disconnect an existing wireless link between base station and headset. The LEDs on the headset and on the base station go off.
- 2 Use a pointed object (e.g. a ball pen) to set the DIP switches to the desired position.

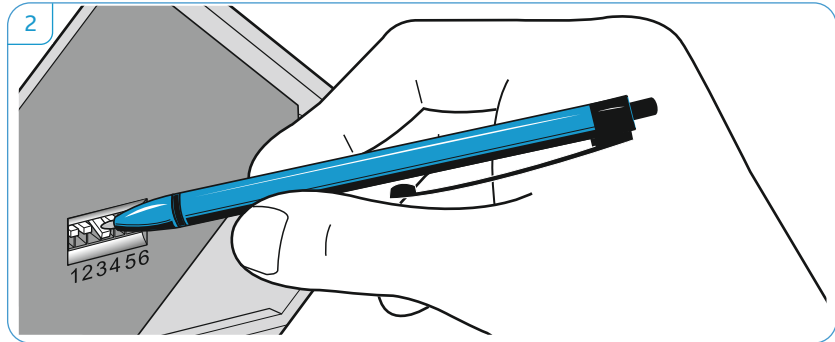
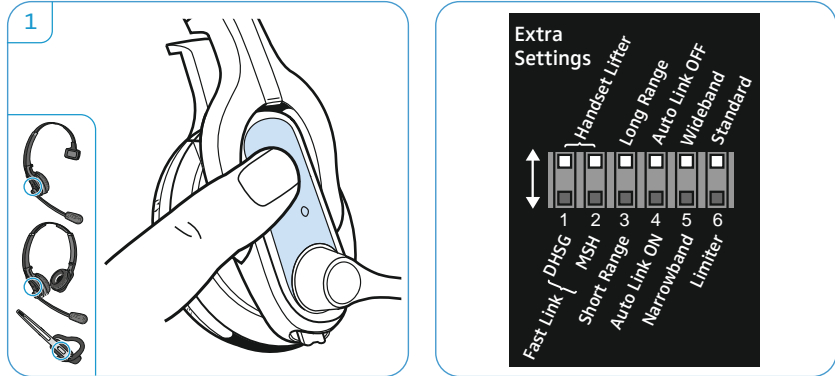

### Configuring the handset lifter/hook switch – DIP switches 1 and 2

The DIP switches 1 and 2 are only assigned a function on the DW BS, DW BS ML and DW BS Phone base stations.



Switch position	Function
	<b>Manual operation</b> Lifts/hangs up the handset manually or using the handset lifter (Sennheiser HSL 10 II).
	<b>Electronic hook switch (DHSG standard)</b> Call control via the headset system. For faster link establishment, see Fast Link.
	<b>Electronic hook switch (MSH standard)</b> Call control via the headset system.
	<b>Fast Link for DHSG standard and HSL 10 II handset lifter</b> Recommended for frequent callers. Shorter battery life. Fast link establishment without delay due to hidden link to the base station.

### Adjusting the radio range – DIP switch 3

If many DECT systems are operated in a confined space, interference can occur. In this case, you should change the radio range.

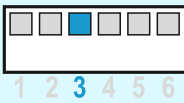
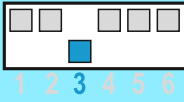
Switch position	Function
 <p>1 2 3 4 5 6</p>	<b>Standard radio range</b>
 <p>1 2 3 4 5 6</p>	<b>Reduced radio range</b> Use this setting in order to avoid interference with other DECT systems Range of approx. 10 m indoors

### Automatically establishing the wireless link between headset and base station (Auto Link) – DIP switch 4

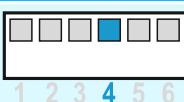
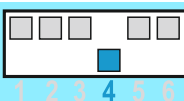

Switch position	Function
 <p>1 2 3 4 5 6</p>	<b>Manual link establishment</b> When taking the headset out of the base station, you have to manually establish the wireless link between headset and base station.
 <p>1 2 3 4 5 6</p>	<b>Automatic link establishment – Auto Link</b> When taking the headset out of the base station, a wireless link is automatically established between headset and base station.

### Switching between wideband and narrowband audio transmission – DIP switch 5

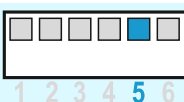
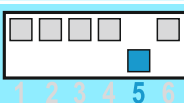

Switch position	Function
 <p>1 2 3 4 5 6</p>	<b>Wideband audio transmission</b> Automatic frequency adjustment of wideband and narrowband calls. Wideband audio transmission is e.g. supported by Skype and gives high speech quality. Battery life: 8 hours
 <p>1 2 3 4 5 6</p>	<b>Narrowband audio transmission</b> Battery life: 12 hours

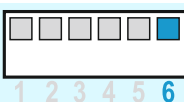
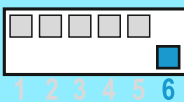
### Limiting the volume – DIP switch 6

Switch position	Function
 <p>1 2 3 4 5 6</p>	<b>Standard limitation</b>
 <p>1 2 3 4 5 6</p>	<b>Limited volume (country specific)</b> <ul style="list-style-type: none"> <li>AU version: in compliance with Directive AS/ACIF G616:2006</li> <li>EU and US version: in compliance with Directive 2003/10/EC</li> </ul>

### Adjusting the audio signal by means of the dial tone



- 1 Put on the headset and press the Phone button  on the base station.
- 2 Press the Link button on the headset. The Link LED  lights up blue.
- 3 Lift the handset. You hear a dial tone.
- 4 Set the ABC switch to the position A, B or C so that you can hear a clear dial tone in the headset.

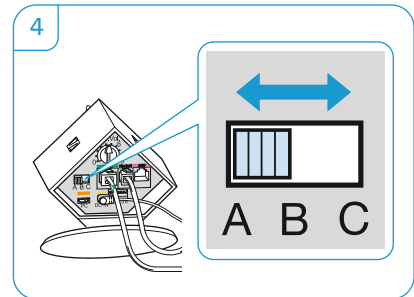
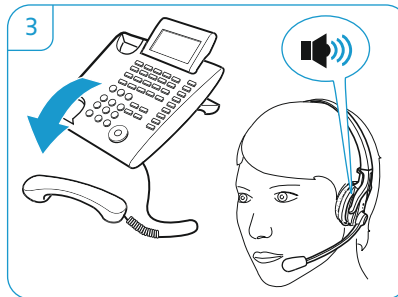
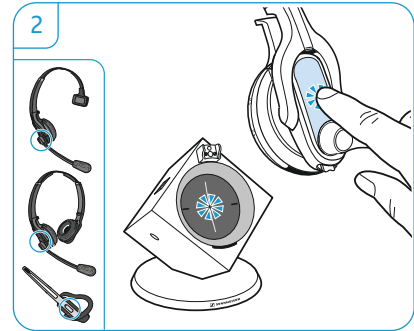
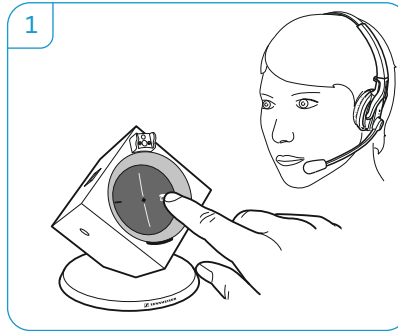



## Adjusting the volume



### Adjusting the microphone volume of the call transmission

By default, the microphone volume control is set to position 4. This setting is suitable for most telephones.

- ▶ Make a call to someone who will help you find the correct sensitivity setting for your microphone.
- ▶ Turn the microphone volume control so that the other party can hear you at a comfortable level.

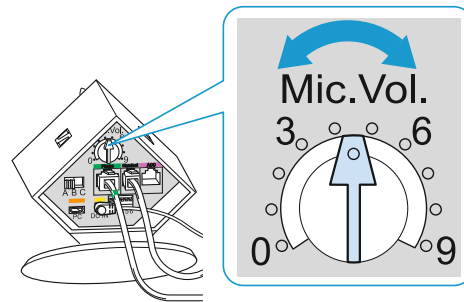

### Adjusting the microphone volume of the USB transmission

Some softphones adjust the microphone sensitivity automatically.



- ▶ Activate this function in order to be able to optimally use the microphone and, via your operating system, adjust the microphone sensitivity so that the other party can hear you at a comfortable level (see the Help function of your operating system).

## Adjusting the automatic audio transmission “Auto Audio”



With the “Auto Audio” function activated and in the case of a USB connection, the audio signals – e.g. from Windows® Media Player® or iTunes® – are automatically transmitted to the headset.

When you receive a call or when a connection to Skype™ is established, the audio transmission stops and you hear for example the ring tone. The “Auto Audio” function is activated by default.

### Activating the “Auto Audio” function:

- ▶ Use a pointed object to press the Set button for approx. 5 seconds. The Link LED ◊ rapidly flashes blue several times.

### Deactivating the “Auto Audio” function:

- ▶ Use a pointed object to press the Set button for approx. 5 seconds. The Link LED ◊ rapidly flashes red several times.

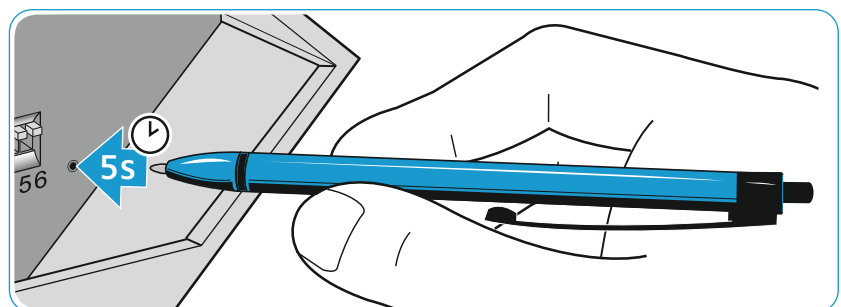

## If a problem occurs

For causes and solutions that are mainly related to the headset, refer to the chapter “If a problem occurs ...” in the “User Guide”.

Problem	Possible cause	Possible solution	Page
The headset is placed into the base station but the Charge status LED is off	Base station is not connected to the mains power supply	Connect the base station to the mains power supply.	6
	Rechargeable battery is deep discharged	Wait several minutes until the Charge status LED lights up.	11
		For quick-charging the headset: Briefly press the Set button at the rear of the base station.	–
Link between headset and base station cannot be established	Base station is only connected via the USB cable	Connect the base station to the mains power supply.	6
Bad radio link between headset and base station	Transmission range is exceeded	Reduce the distance between headset and base station.	–
		Adjust the radio range.	14
Noise interference and connection loss	Too many DECT systems within the radio range	Reduce the radio range.	14
		Set the base station to narrow-band transmission.	14
	Distance between base station and fixed line phone is so small that interference occurs	Increase the distance between base station and fixed line phone.	–
The rechargeable battery cannot be charged	Headset is not properly placed into the magnetic holder of the base station	Check if the headset is properly placed into the magnetic holder.	11
Bad audio quality, the other party sounds too low or too loud	Microphone sensitivity is not correctly adjusted	Adjust the microphone sensitivity.	15
The sound from the fixed line phone is distorted and disturbed	Base station is not adjusted to the fixed line phone	Use the ABC switch to adjust the base station to your fixed line phone.	15

For more information and an FAQ list, please visit our website at [www.sennheiser.com](http://www.sennheiser.com).

If a problem occurs that is not listed in the above table or if the problem cannot be solved with the proposed solutions, please contact your local Sennheiser partner for assistance.

To find a Sennheiser partner in your country, search at [www.sennheiser.com](http://www.sennheiser.com) under “Service & Support”.

## Specifications

### Base station

#### DW BS/DW BS ML

Dimensions	108 x 116 x 114 mm (W x H x D)
Weight	approx. 368 g
Operating temperature range	+5°C to +45°C (+41°F to +113°F)
Storage temperature range	-20°C to +70°C (-4°F to +158°F)

#### DW BS USB/DW BS USB ML/DW BS Phone

Dimensions	108 x 116 x 114 mm (W x H x D)
Weight	approx. 322 g
Operating temperature range	+5°C to +45°C (+41°F to +113°F)
Storage temperature range	-20°C to +70°C (-4°F to +158°F)

### Headset

#### DW Office – HS

Dimensions	140 x 24 x 22 mm (W x H x D)
Weight	with ear hook: approx. 22 g with headband: approx. 50 g
Talk time	narrowband: up to 12 hours wideband: up to 8 hours
Charging time	50%: approx. 20 min 100%: approx. 1 hour
Range (environment dependent)	free line of sight: up to 180 m in office buildings: up to 55 m
Speaker type	dynamic, neodymium magnet
Microphone type	electret microphone, noise canceling
Operating temperature range	+5°C to +45°C (+41°F to +113°F)
Storage temperature range	-20°C to +70°C (-4°F to +158°F)

#### DW Pro1/Pro2 – HS (DW 10)

Dimensions	170 x 175 x 55 mm (W x H x D)
Weight	Pro1: approx. 65 g Pro2: approx. 85 g
Talk time	narrowband: up to 12 hours wideband: up to 8 hours
Charging time	50%: approx. 20 min 100%: approx. 1 hour
Range (environment dependent)	free line of sight: up to 180 m in office buildings: up to 55 m
Speaker type	dynamic, neodymium magnet
Microphone type	electret microphone, ultra noise canceling
Operating temperature range	+5°C to +45°C (+41°F to +113°F)
Storage temperature range	-20°C to +70°C (-4°F to +158°F)

### Power supply unit

Nominal input voltage	100 – 240 V~
Nominal input current	max. 0.2 A
Mains frequency	50 – 60 Hz
Nominal output voltage	5 V ---
Nominal output current	max. 850 mA
Operating temperature range	+5°C to +45°C (+41°F to +113°F)
Storage temperature range	-20°C to +70°C (-4°F to +158°F)
Relative humidity	operation: 20 to 85% storage: 20 to 95%
Weight	approx. 75 g

### DECT

	EU, UK, AU: CAT IQ 1.0	US version: DECT 6.0
Frequency	1,880 to 1,900 MHz	1,920 to 1,930 MHz
SAR value of DW Office – HS	0.196 W/kg (max. 10 g SAR)	0.093 W/kg (max. 1 g SAR)
SAR value of DW Pro1 – HS	0.069 W/kg (max. 10 g SAR)	0.044 W/kg (max. 1 g SAR)
SAR value of DW Pro2 – HS	0.058 W/kg (max. 10 g SAR)	0.025 W/kg (max. 1 g SAR)

### In compliance with

Europe:	EMC	EN 301489-6
<b>CE</b>	Radio	EN 301406
	Safety	EN 60950-1
	SAR	EN 50360 ref EN 62209-1 (headset)

### Trademarks

Sennheiser is a registered trademark of Sennheiser electronic GmbH & Co. KG. Other product and company names mentioned in this instruction manual may be the trademarks or registered trademarks of their respective owners.



Sennheiser Communications A/S  
Industriparken 27, DK-2750 Ballerup, Denmark  
[www.sennheiser.com](http://www.sennheiser.com)

Printed in China, Publ. 11/18, A06