

USB HEADSET H340

Complete Setup Guide

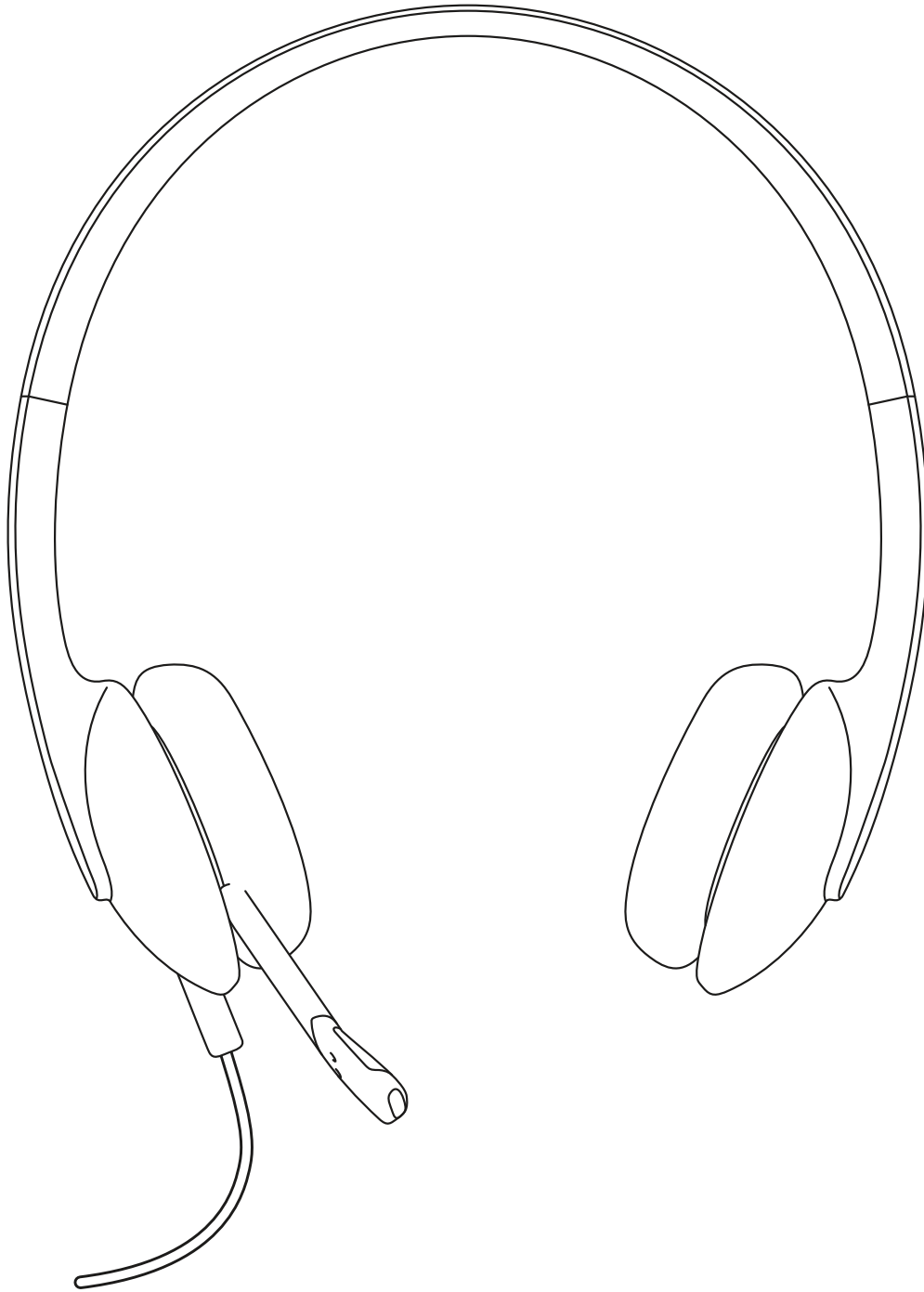

logitech®

CONTENTS

English	3	Česká verze	33
Deutsch	5	Slovenčina	35
Français	7	Українська	37
Italiano	9	Eesti	39
Español	11	Latviski	41
Português	13	Lietuvių	43
Nederlands	15	Български	45
Svenska	17	Hrvatski	47
Dansk	19	Srpski	49
Norsk	21	Slovenščina	51
Suomi	23	Română	53
Ελληνικά	25	Türkçe	55
По-русски	27	57. العربية	
Po polsku	29	59. עברית	
Magyar	31		

KNOW YOUR PRODUCT

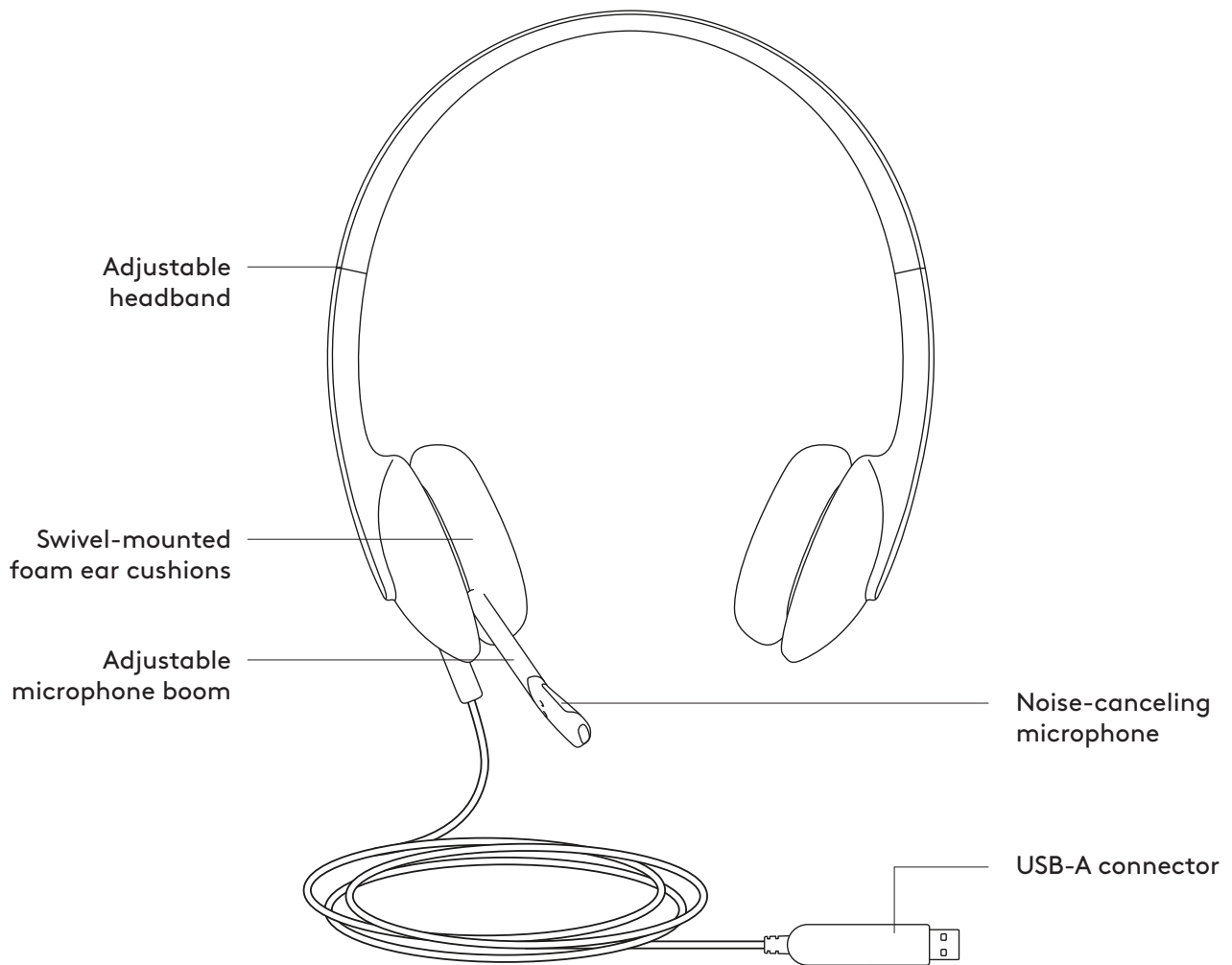

CONNECTING THE HEADSET

Plug the USB-A connector into the computer USB port.



HEADSET FIT

1. To adjust headset size, move the headband up and down until it fits comfortably.
2. Move the flexible microphone boom up or down and in or out until it is level with your mouth for better voice capture.
3. Boom can be tucked out of the way when not being used.

1

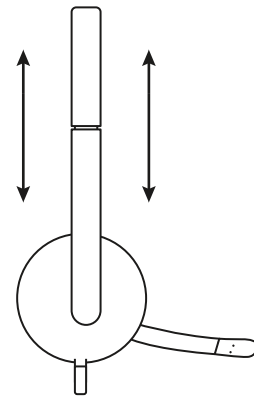

2

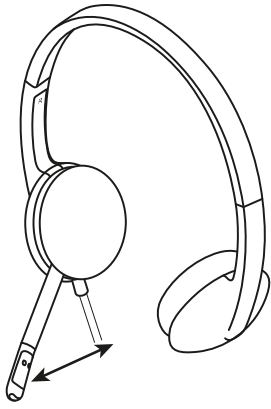

3

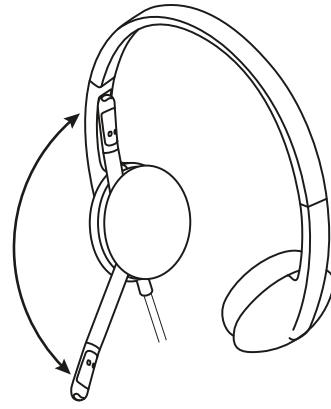

www.logitech.com/support/H340

PRODUKT AUF EINEN BLICK

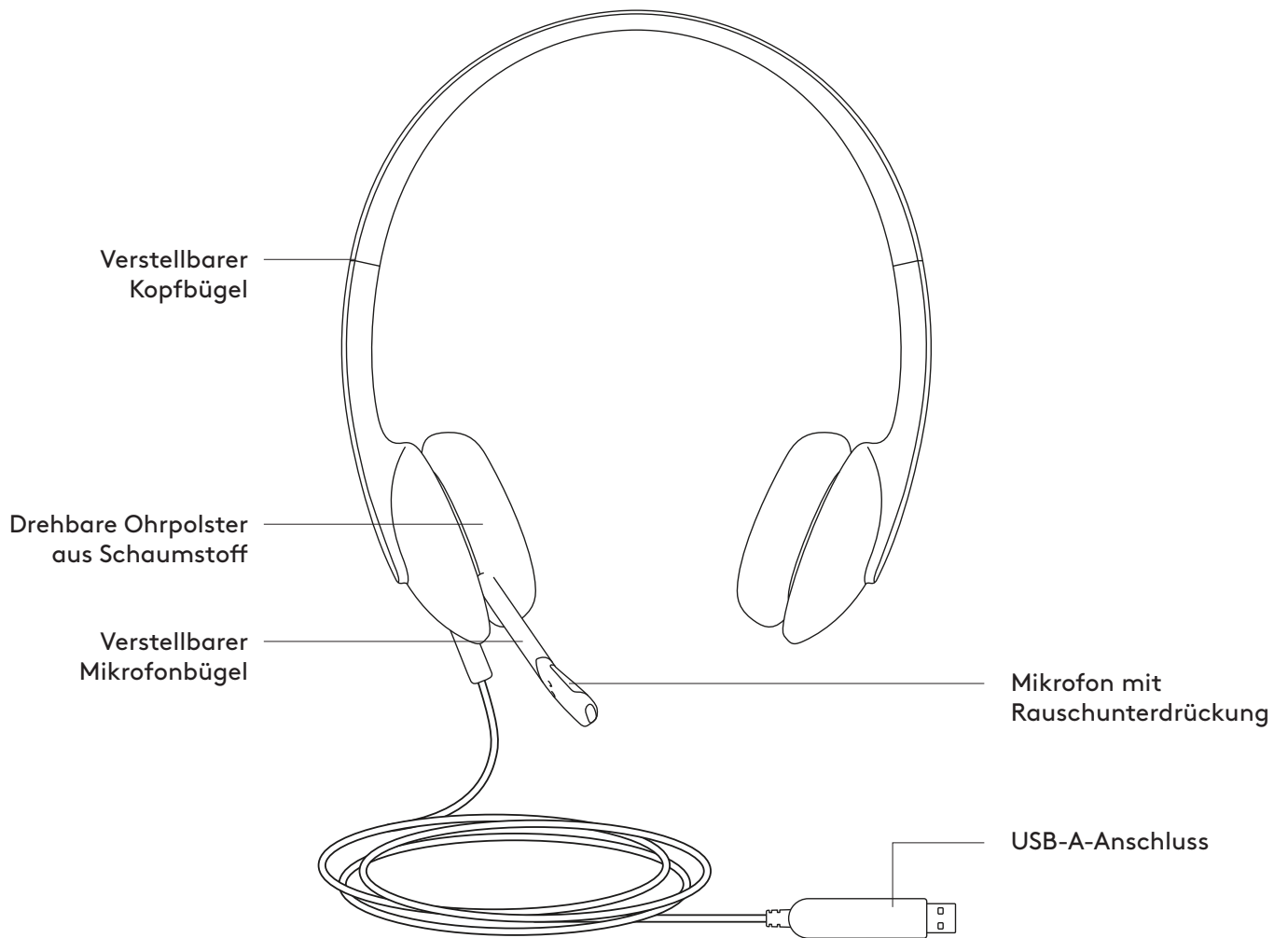

VERBINDEN DES HEADSETS

Stecken Sie den Unifying Empfänger an einem USB-Anschluss am Computer ein.



HEADSET-ANPASSUNG

1. Bewegen Sie zum Anpassen der Größe des Headsets den Kopfbügel auf und ab, bis es bequem sitzt.
2. Bewegen Sie das flexible Bügelmikrofon so, dass es sich auf Höhe Ihres Mundes befindet, um eine optimale Spracherfassung zu erreichen.
3. Das Bügelmikrofon lässt sich nach oben wegklappen, wenn Sie es nicht benötigen.

1

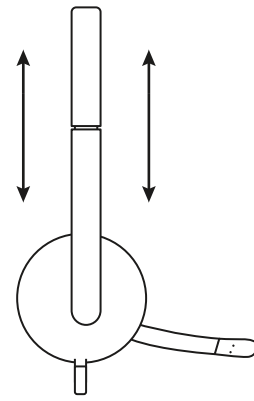

2

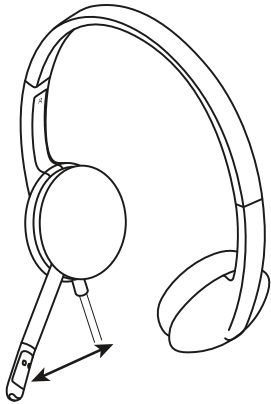

3

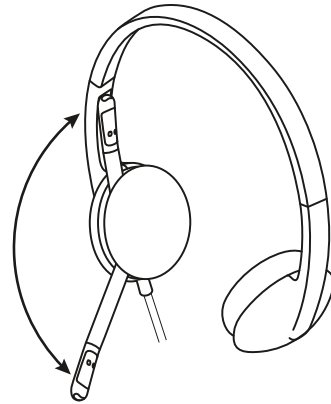

www.logitech.com/support/H340

PRÉSENTATION DU PRODUIT

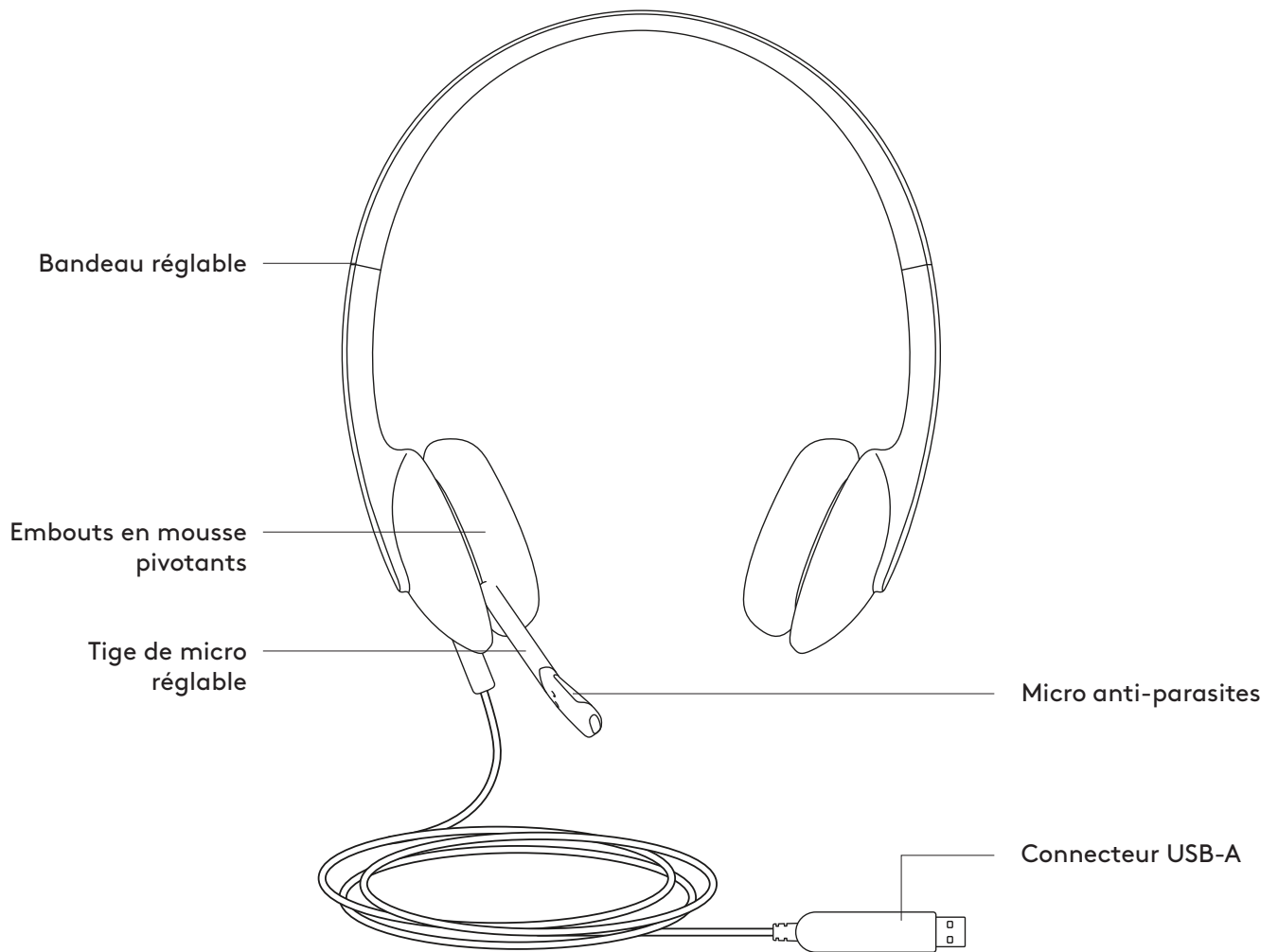

BRANCHEMENT DU CASQUE

Branchez le connecteur USB-A sur un port USB de l'ordinateur.



AJUSTEMENT DU CASQUE

1. Pour ajuster la taille du casque, déplacez le bandeau de haut en bas jusqu'à ce qu'il soit confortable.
2. Déplacez la tige flexible du microphone vers le haut ou vers le bas et vers l'intérieur ou l'extérieur jusqu'à ce qu'il soit au niveau de votre bouche pour une meilleure capture de la voix.
3. La tige peut être rabattue lorsque vous ne l'utilisez pas.

1

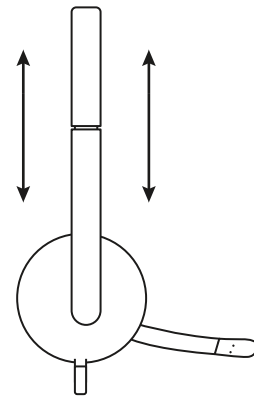

2

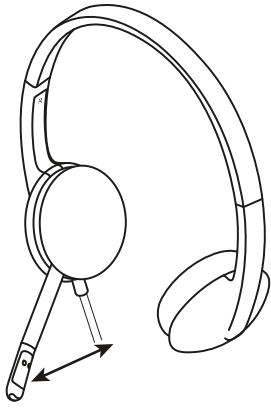

3

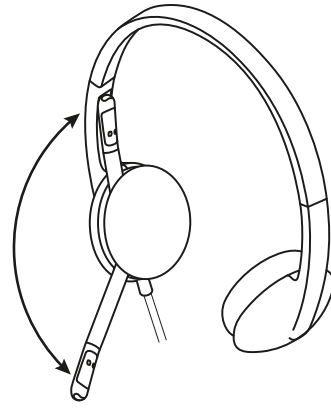

www.logitech.com/support/H340

PANORAMICA DEL PRODOTTO

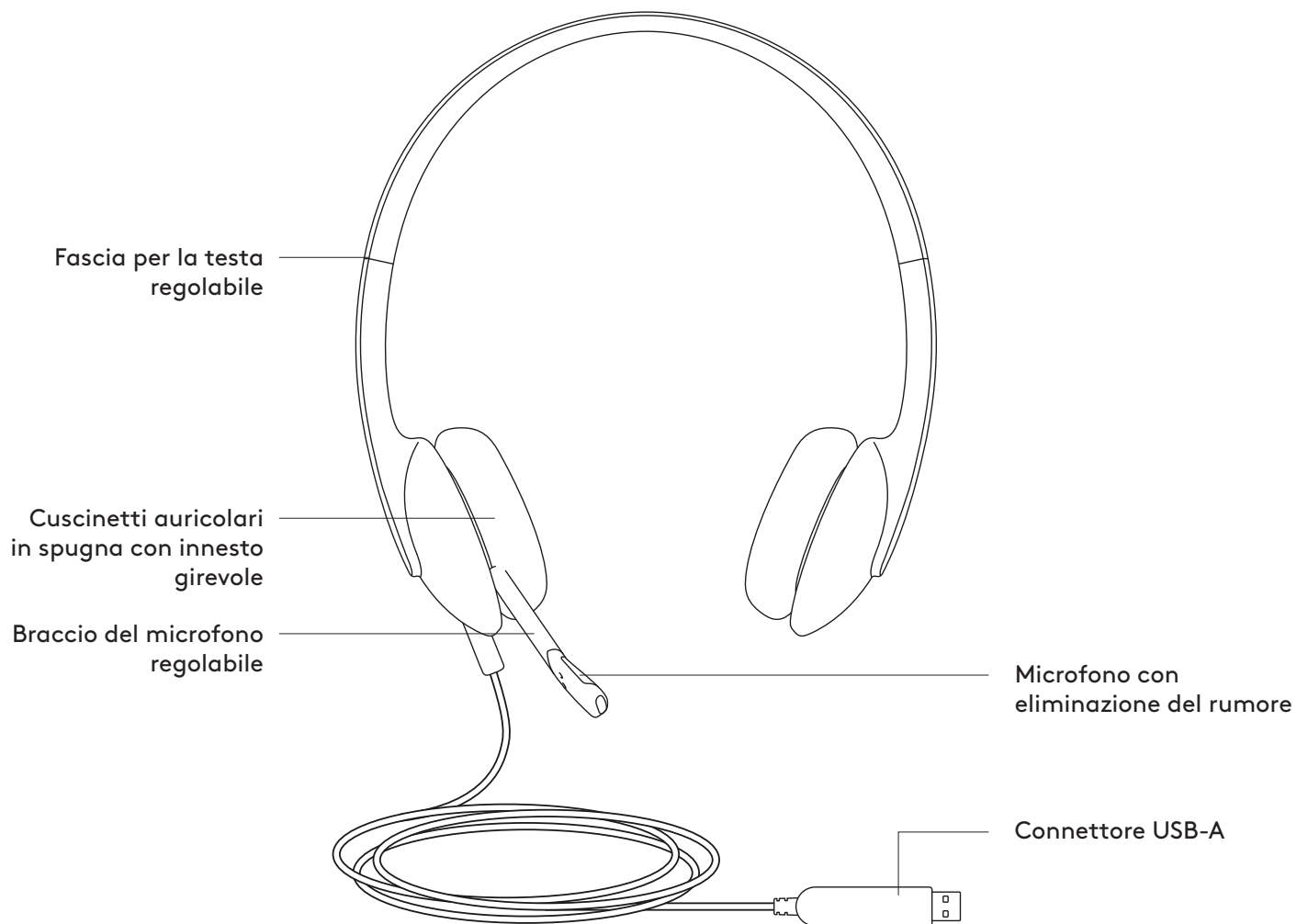

CONNESSIONE DELLA CUFFIA CON MICROFONO

Collegare il connettore USB-A alla porta USB del computer.

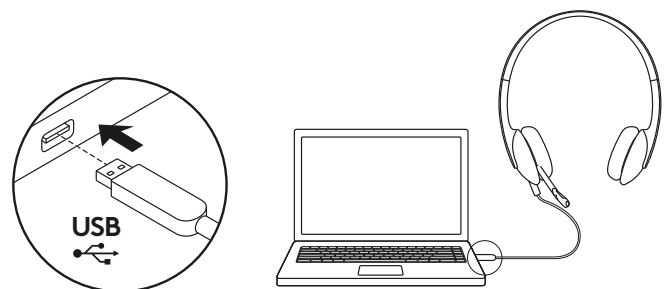

ADATTAMENTO DELLA CUFFIA CON MICROFONO

1. Per adattare le dimensioni della cuffia con microfono, sposta la fascia per la testa in alto e in basso finché non si posiziona comodamente.
2. Sposta il braccio del microfono flessibile in alto o in basso e verso l'interno o verso l'esterno fino a portarlo all'altezza della bocca, per un'acquisizione ottimale della voce.
3. Sposta il microfono fuori portata quando non lo utilizzi.

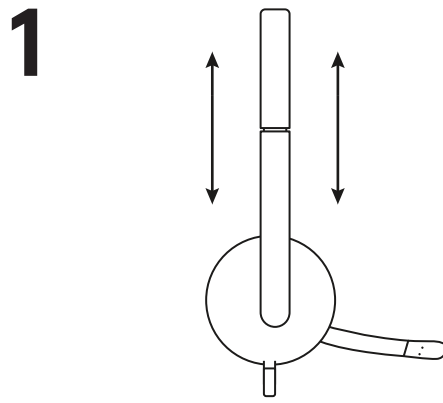

2

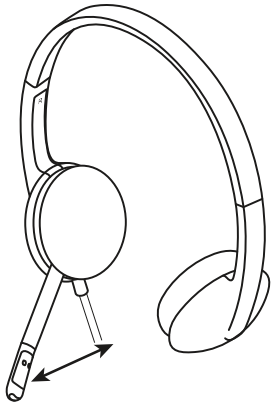

3

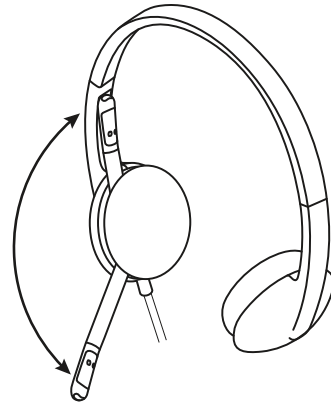

www.logitech.com/support/H340

COMPONENTES DEL PRODUCTO

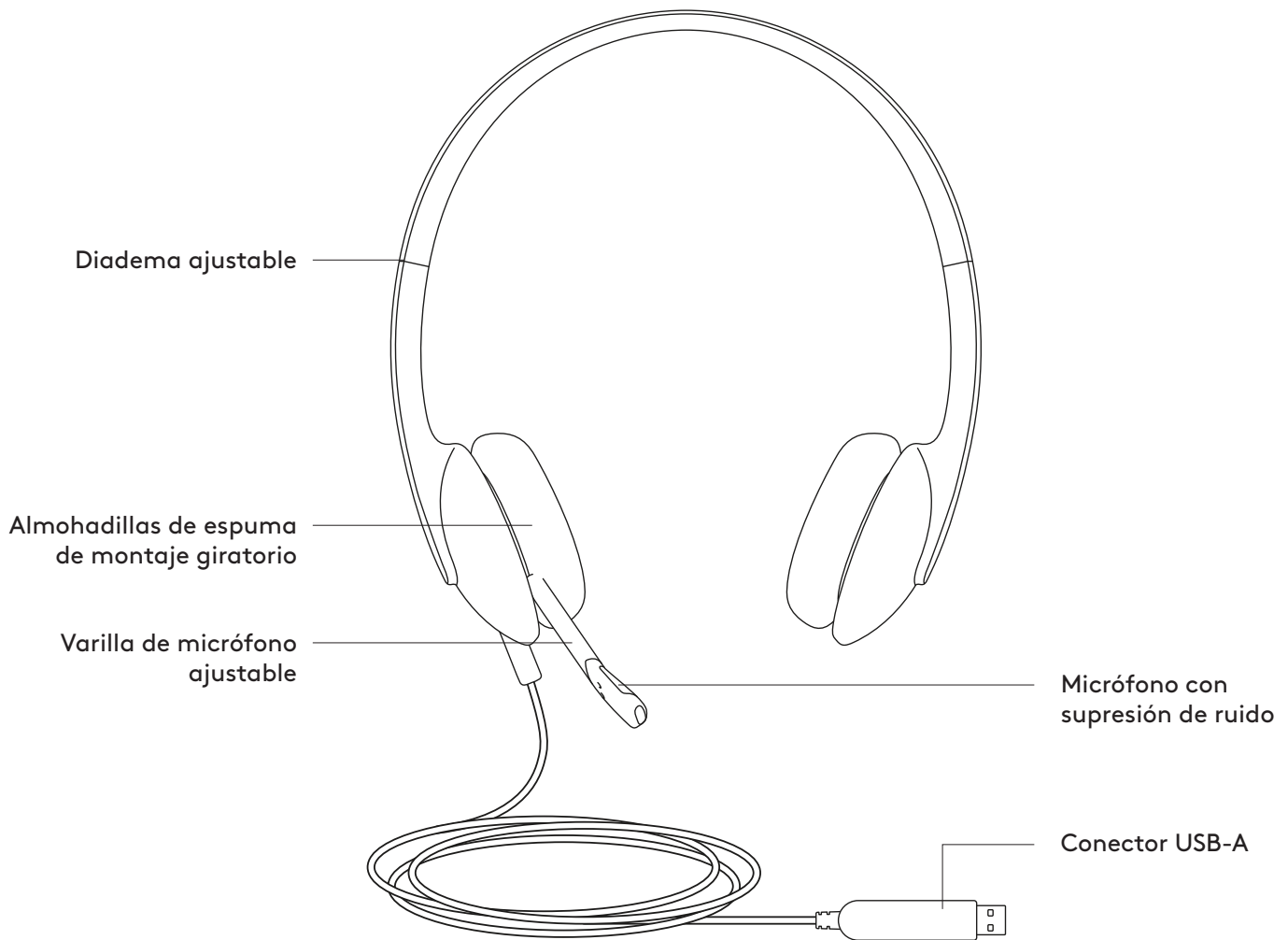

CONEXIÓN DE LOS AURICULARES

Conecta el conector USB-A al puerto USB del ordenador.



AJUSTE DE LOS AURICULARES

1. Para ajustar el tamaño de los auriculares, sube y baja la diadema hasta que te resulten cómodos.
2. Mueve la varilla de micrófono flexible hacia arriba o hacia abajo y hacia adentro o hacia afuera hasta que esté al nivel de la boca para una mejor captura de voz.
3. La varilla se puede guardar, para que no estorbe cuando no se use.

1

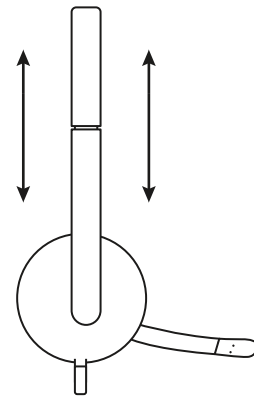

2

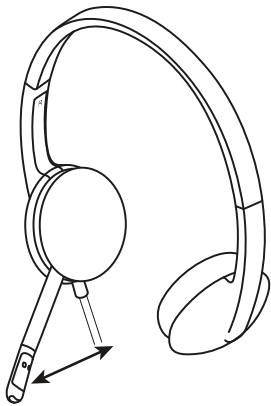

3

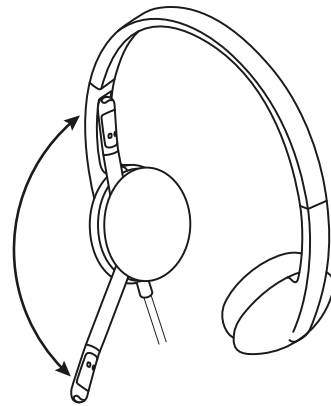

www.logitech.com/support/H340

CONHEÇA O SEU PRODUTO

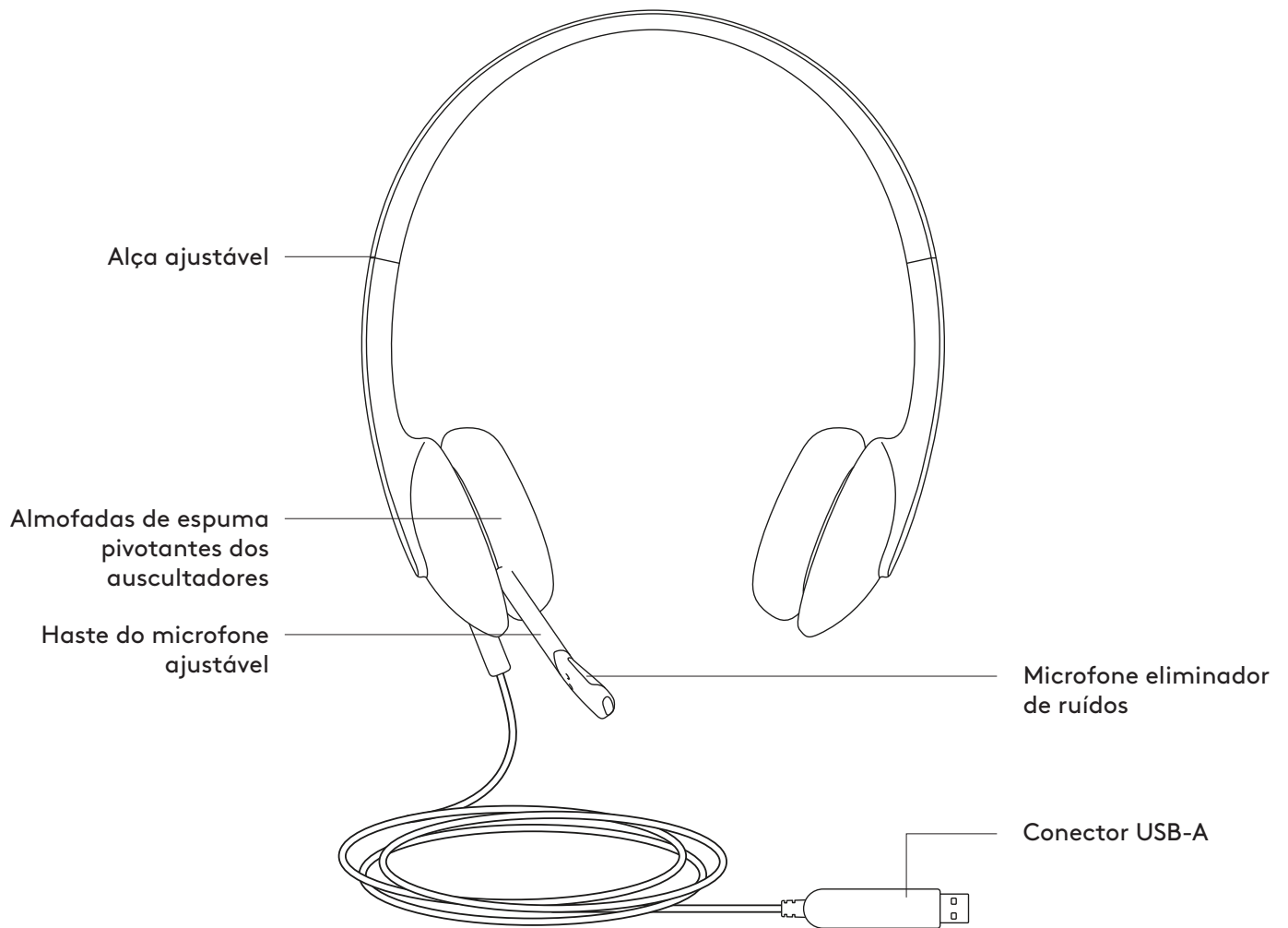

LIGAR OS AUSCULTADORES

Ligue o conector USB-A à porta USB do computador.

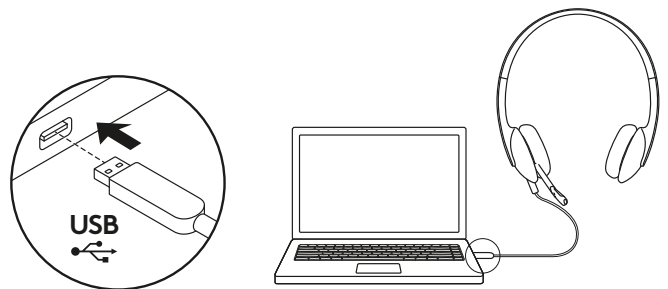

AJUSTE DOS AUSCULTADORES

1. Para ajustar o tamanho dos auscultadores, mova a alça para cima e para baixo até encontrar o ajuste adequado.
2. Mova a haste flexível do microfone para cima e para baixo e para dentro ou para fora até estar ao nível da boca para obter a melhor captação de voz.
3. Recolha a haste do microfone quando não o estiver a utilizar.

1

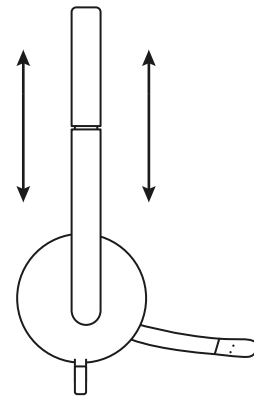

2

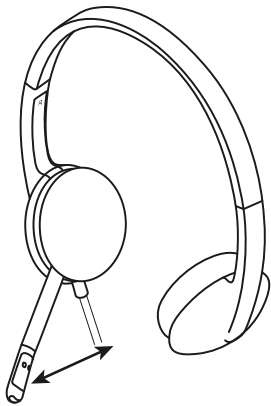

3

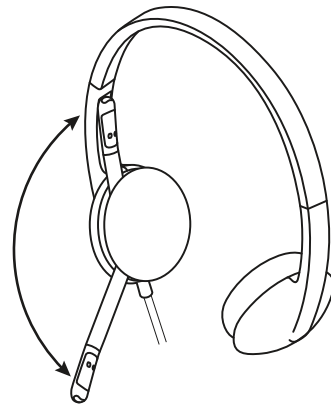

www.logitech.com/support/H340

KEN JE PRODUCT

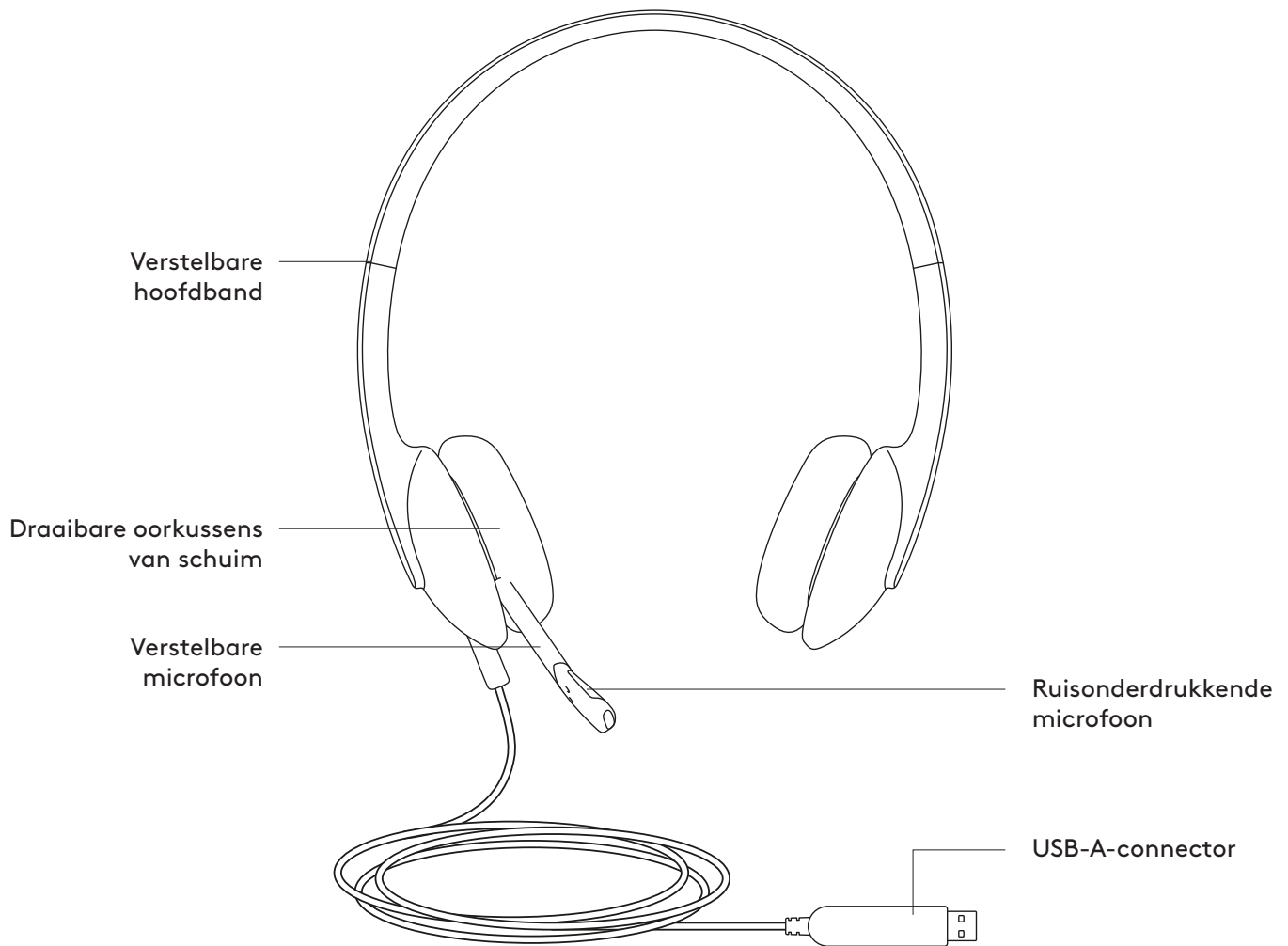

DE HEADSET AANSLUITEN

Sluit de USB-A-connector aan op de USB-poort van de computer.



PASVORM VAN DE HEADSET

1. Pas de headset aan door de hoofdband omhoog en omlaag te bewegen tot deze comfortabel zit.
2. Beweeg de flexibele microfoon omhoog of omlaag en naar je toe en van je af tot deze op één lijn is met je mond voor betere stemopname.
3. De microfoon kan worden weggestopt wanneer je deze niet nodig hebt.

1

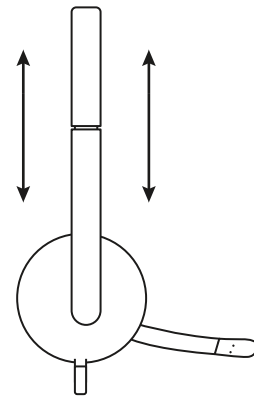

2

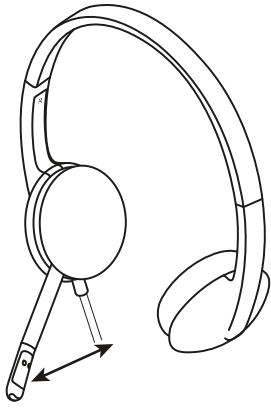

3

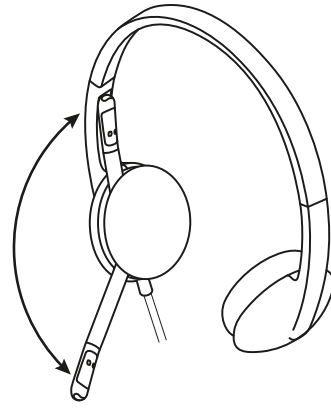

www.logitech.com/support/H340

PRODUKTÖVERSIKT

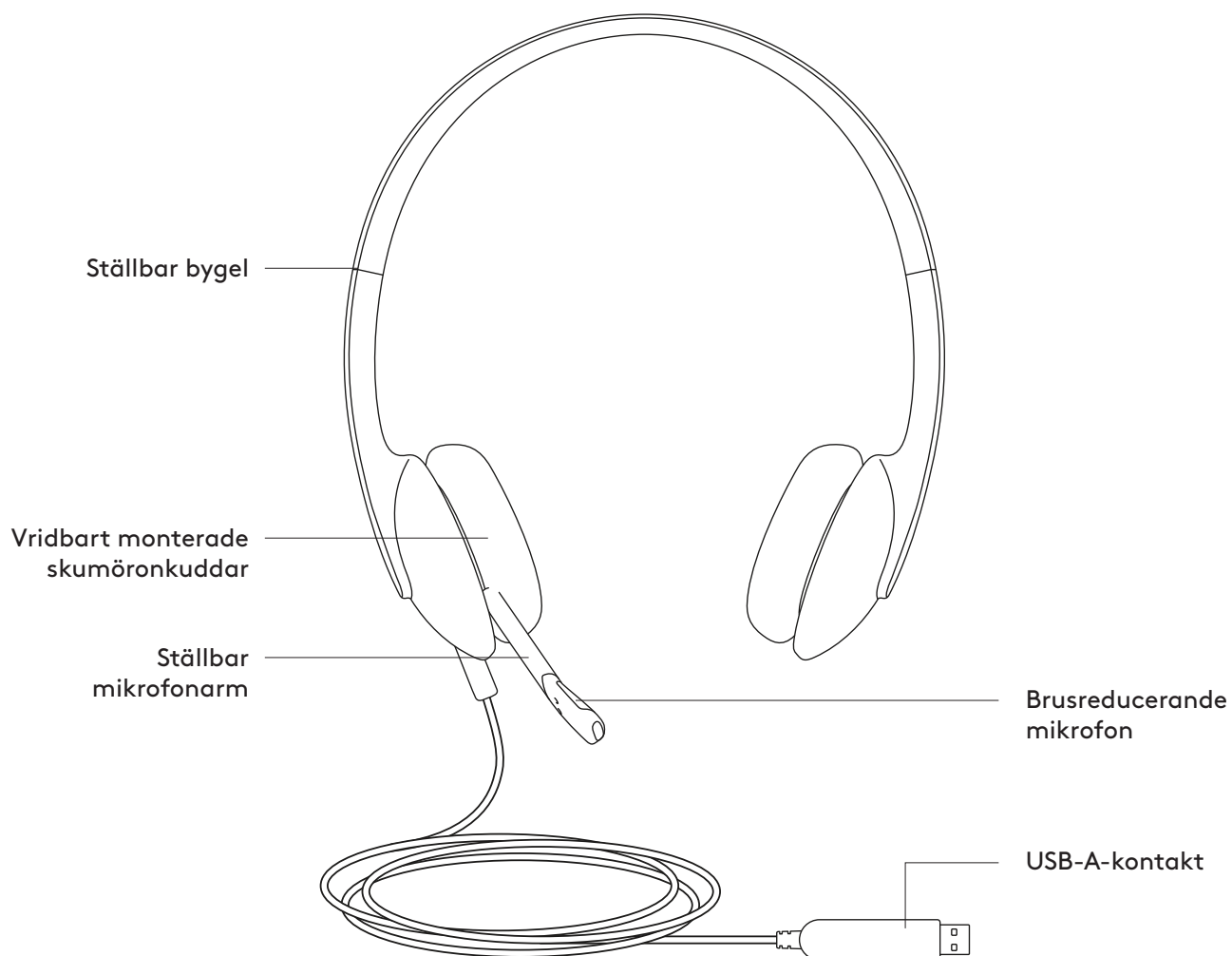

ANSLUTA HEADSETET

Anslut USB-A-kontakten till en USB-port på datorn.

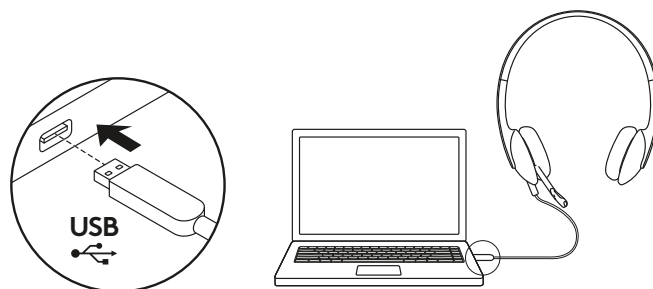

STÄLLA IN HEADSETET

1. Justera headsetets storlek genom att flytta bygeln upp och ner tills headsetet sitter bekvämt.
2. Flytta den rörliga mikrofonarmen upp eller ner och inåt eller utåt tills den är i höjd med din mun för bättre röstupptagning.
3. Mikrofonbommen kan flyttas ur vägen när den inte används.

1

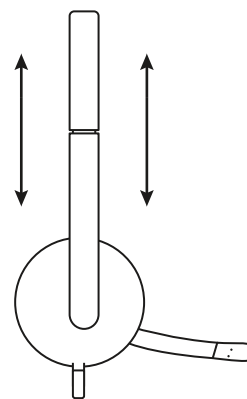

2

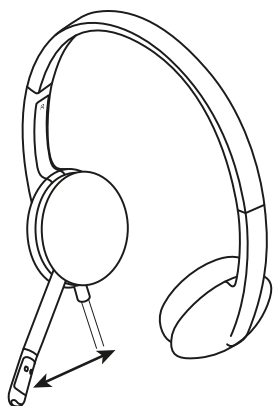

3

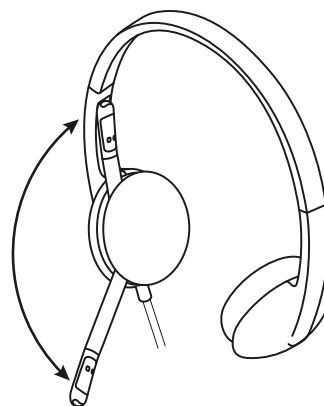

www.logitech.com/support/H340

OVERSIGT OVER PRODUKTET

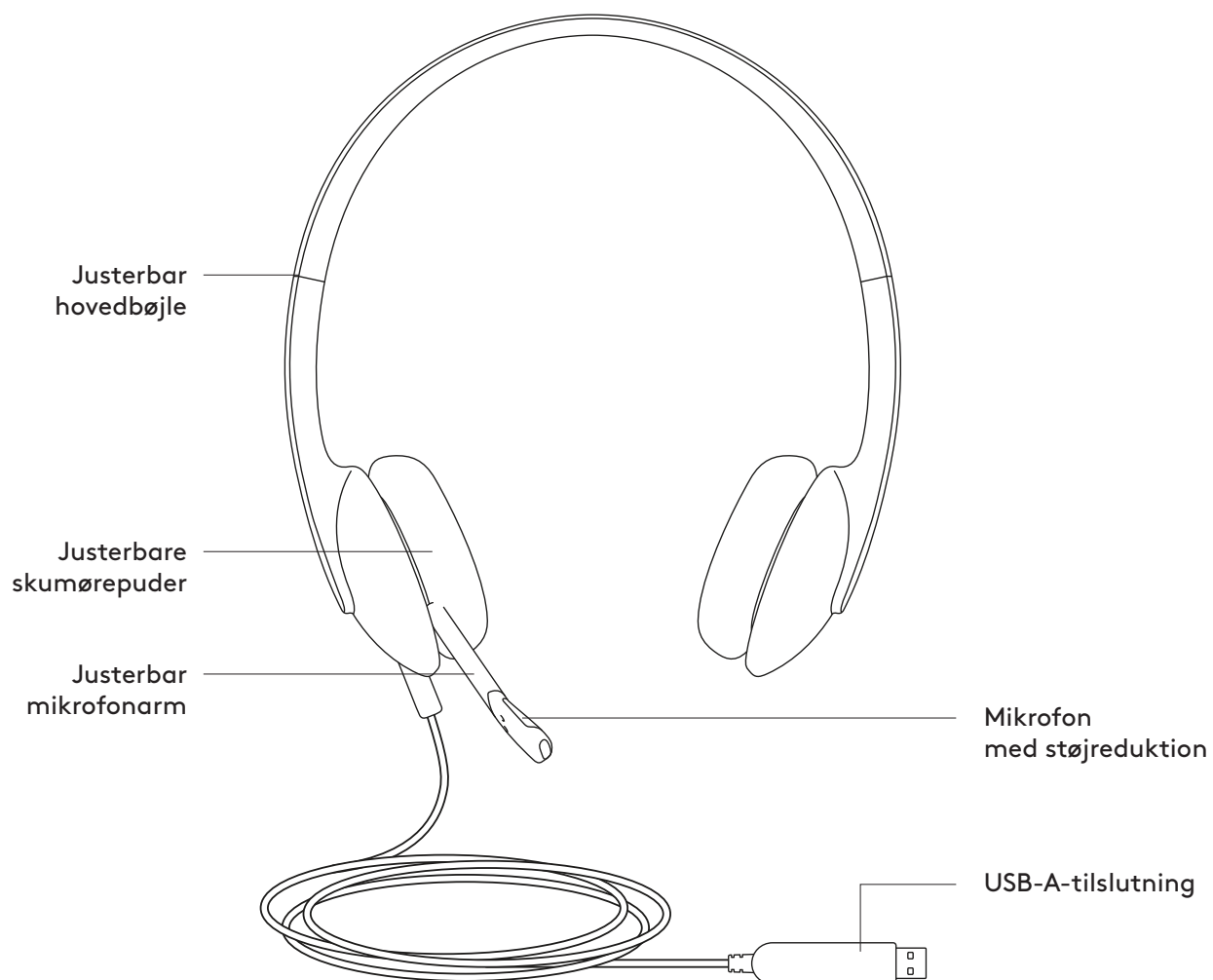

TILSLUTNING AF HEADSETTET

Slut USB-A-stikket til en USB-port på computeren.

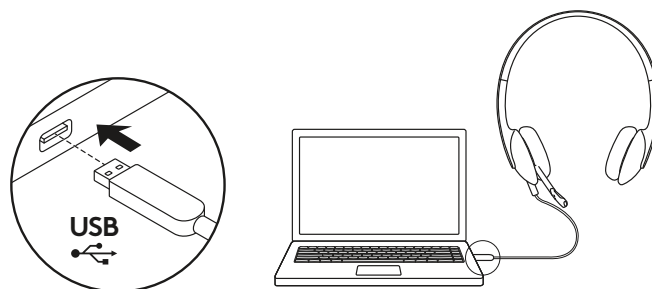

TILPASNING AF HEADSETTET

1. Headsettet justeres i størrelsen ved at flytte hovedbøjlen op og ned, til det føles behageligt.
2. Den fleksible mikrofonarm kan flyttes op eller ned, til den er ud for din mund, så du får den bedste lyd.
3. Mikrofonarmen kan gemmes af vejen når du ikke bruger mikrofonen.

1

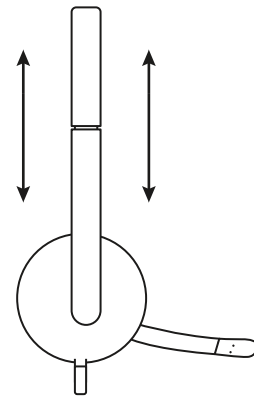

2

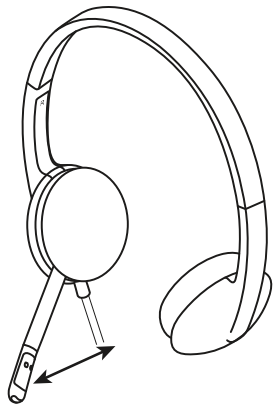

3

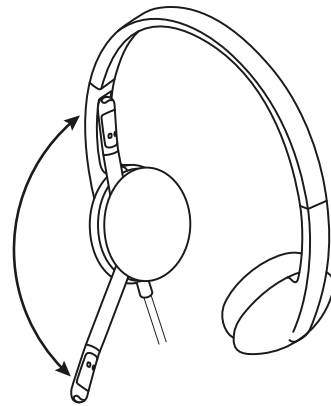

www.logitech.com/support/H340

BLI KJENT MED PRODUKTET

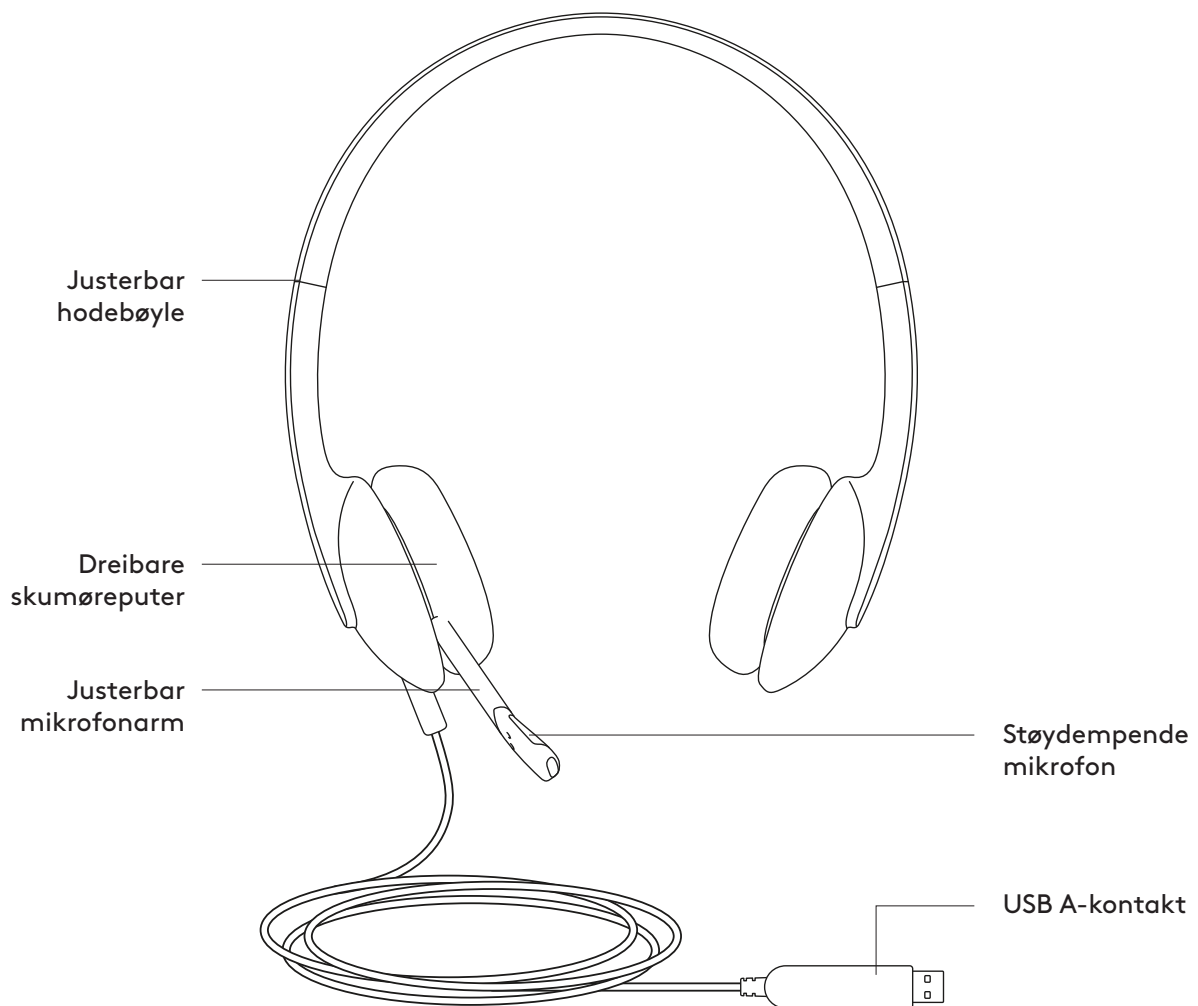

KOBLE TIL HEADSETTET

Koble Unifying-mottakeren til en USB-port på datamaskinen.



JUSTERE HEADSETTET

1. Juster headsetstørrelsen ved å flytte hodebøylen opp og ned til det sitter behagelig.
2. Flytt den fleksible mikrofonen opp eller ned og inn eller ut til den er på samme nivå som munnen for å gjøre det enklere å fange opp stemmen din.
3. Telefonarmen kan skyves unna når du ikke bruker den.

1

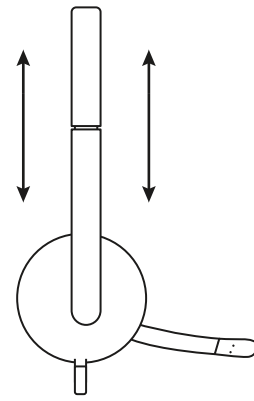

2

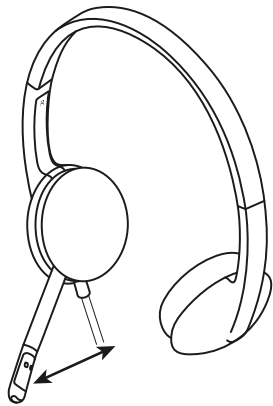

3

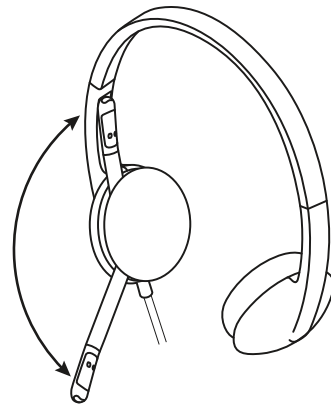

www.logitech.com/support/H340

TUNNE TUOTTEESI

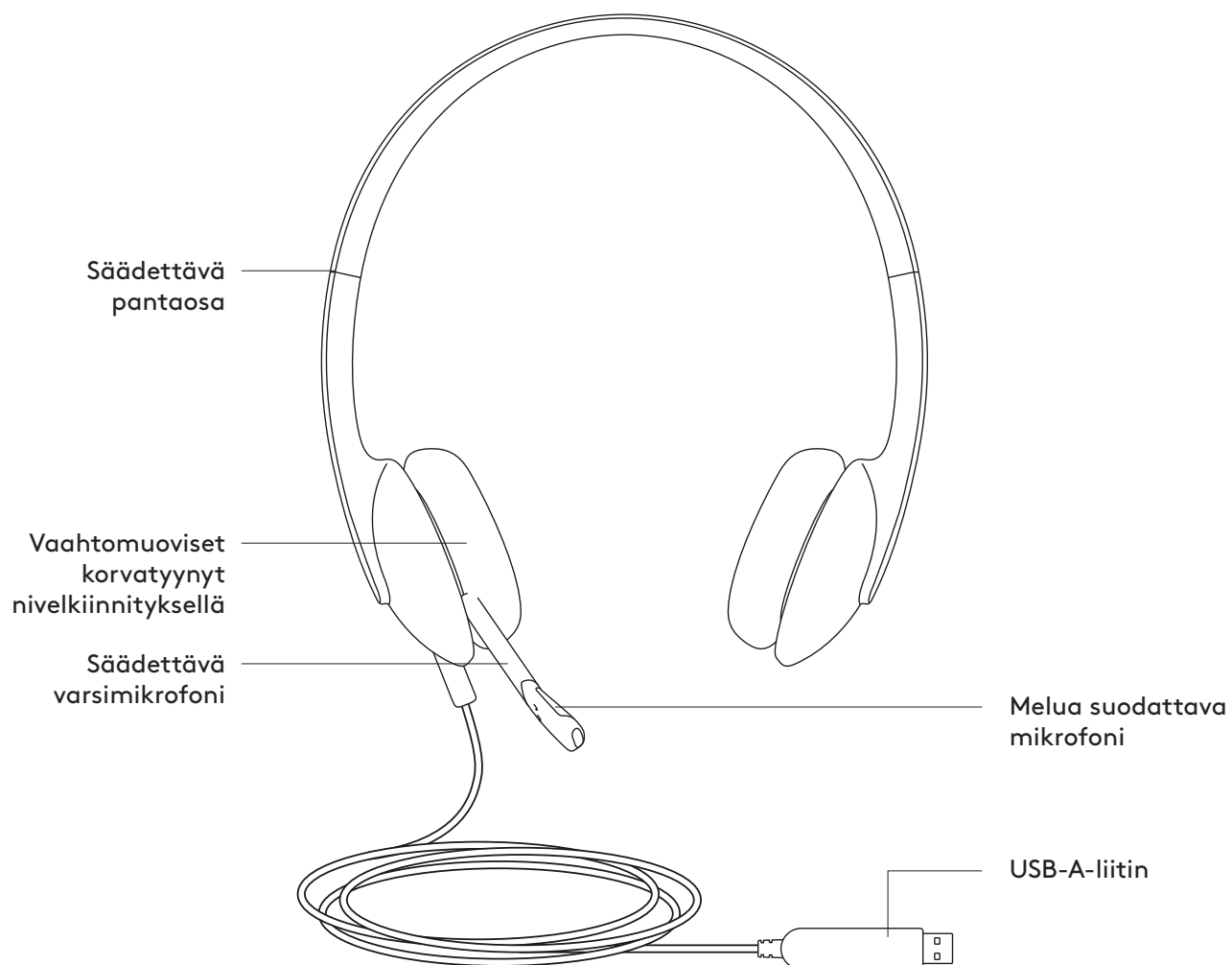

KUULOKEMIKROFONIN LIITTÄMINEN

Kytke USB-A-liitin tietokoneen USB-porttiin.

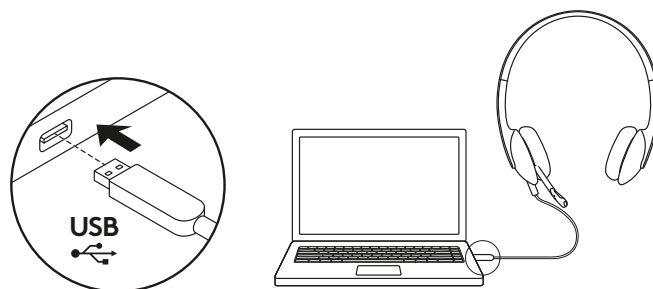

KUULOKEMIKROFONIN ISTUVUUS

1. Säädä kuulokkeen kokoa siirtämällä pantaosaa ylös ja alas, kunnes se istuu mukavasti.
2. Liikuta joustavaa mikrofoniin vartta äänenlaadun parantamiseksi ylös- tai alaspäin tai sisään tai ulos, kunnes se on suusi tasolla.
3. Mikrofonivarsi voidaan painaa pois tieltä, kun sitä ei tarvita.

1

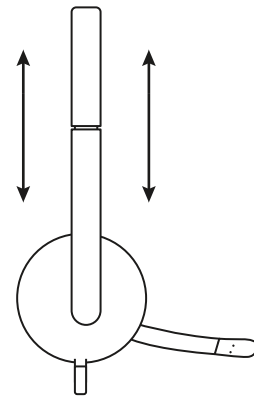

2

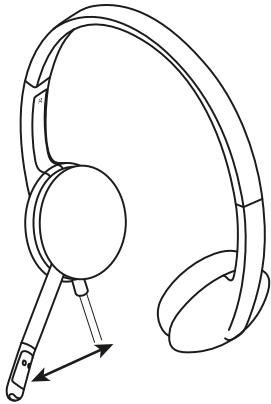

3

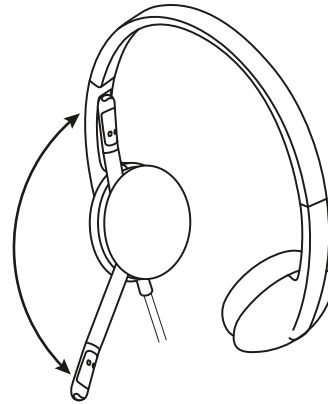

www.logitech.com/support/H340

ΓΝΩΡΙΣΤΕ ΤΟ ΠΡΟΪΟΝ

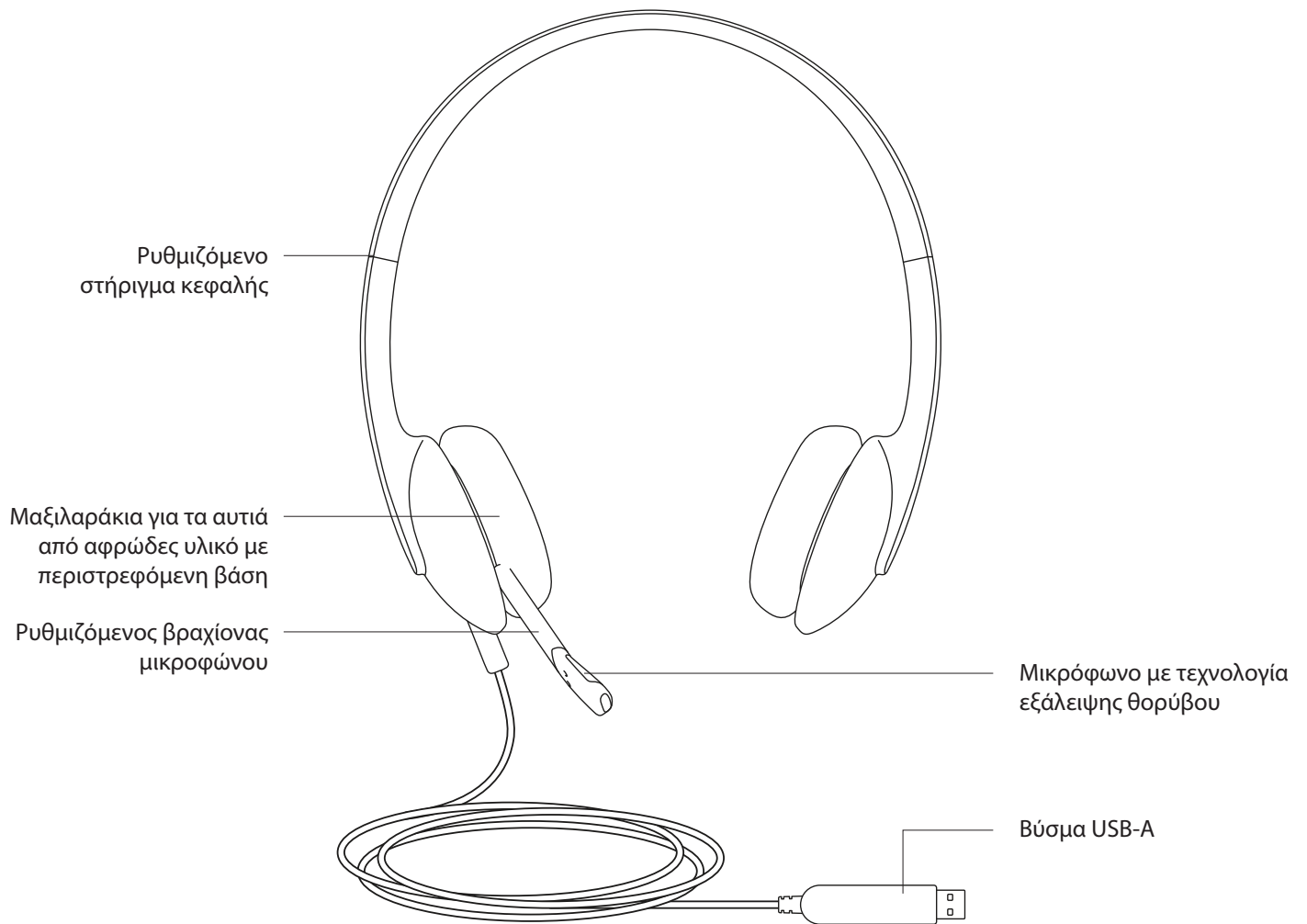

ΣΥΝΔΕΣΗ ΤΟΥ ΣΕΤ ΜΙΚΡΟΦΩΝΟΥ-ΑΚΟΥΣΤΙΚΩΝ

Συνδέστε το βύσμα USB-A στην θύρα USB του υπολογιστή.



ΕΦΑΡΜΟΓΗ ΣΕΤ ΜΙΚΡΟΦΩΝΟΥ-ΑΚΟΥΣΤΙΚΩΝ

1. Για να προσαρμόσετε το μέγεθος του σκετ μικροφώνου-ακουστικών, μετακινήστε το στήριγμα κεφαλής προς τα επάνω και προς τα κάτω μέχρι να εφαρμόσει άνετα στο κεφάλι σας.
2. Μετακινήστε τον εύκαμπτο βραχίονα του μικροφώνου προς τα επάνω ή προς τα κάτω και μέσα ή έξω μέχρι να το ευθυγραμμίσετε με το στόμα σας, για να καταγράψει καλύτερα τη φωνή σας.
3. Το μικρόφωνο μπορεί να μετακινηθεί για να μην ενοχλεί όταν δεν χρησιμοποιείται.

1

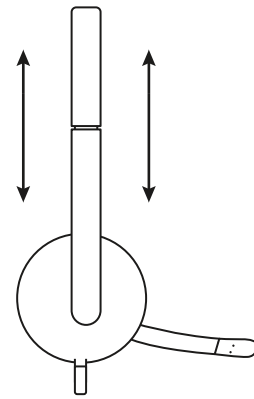

2

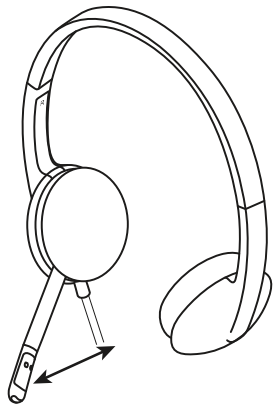

3

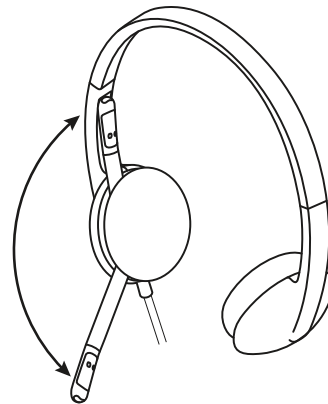

www.logitech.com/support/H340

ЗНАКОМСТВО С ПРОДУКТОМ

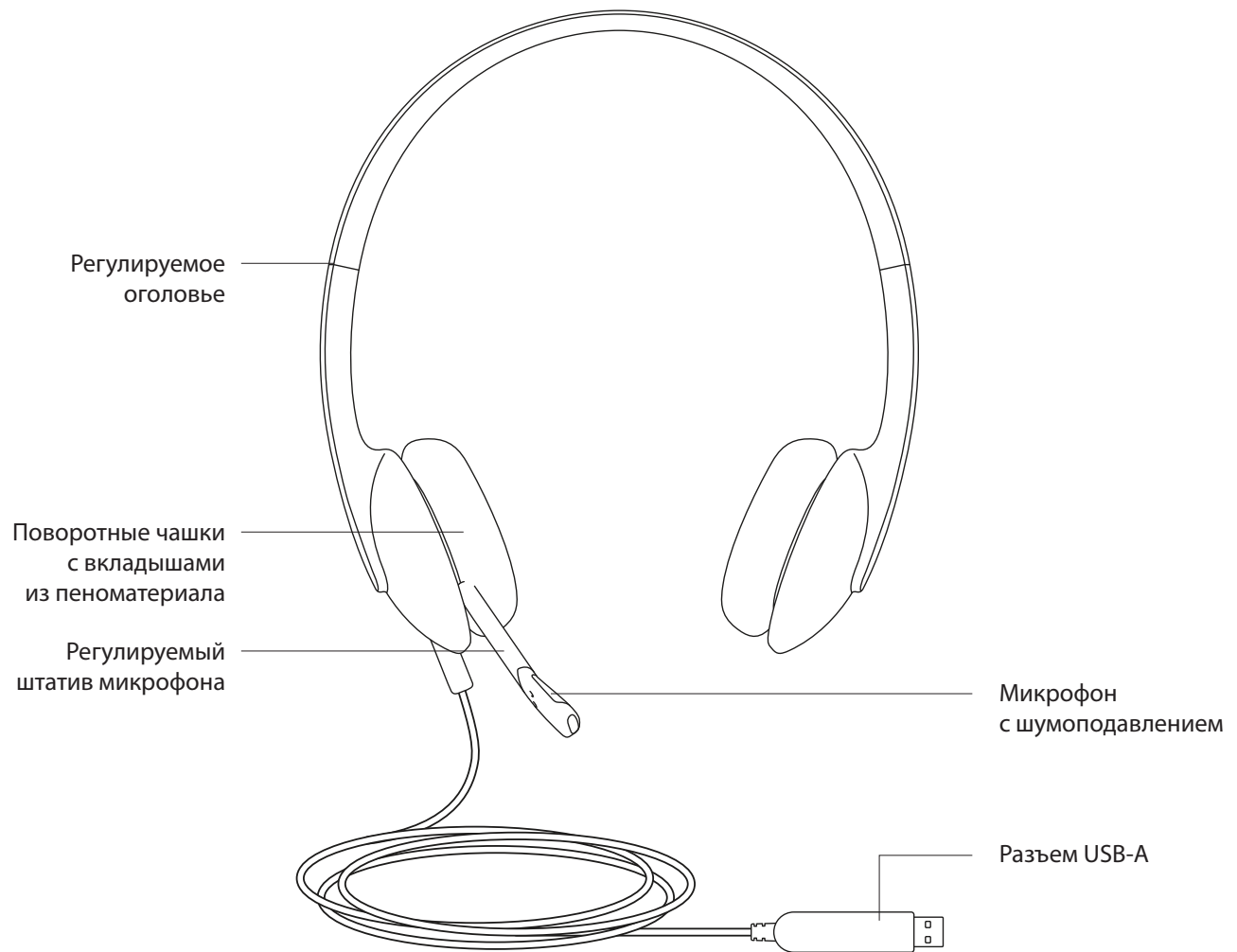

ПОДКЛЮЧЕНИЕ ГАРНИТУРЫ

Вставьте штекер USB-A в USB-порт компьютера.



ПОСАДКА ГАРНИТУРЫ

1. Чтобы подобрать нужный размер гарнитуры, двигайте оголовье вверх-вниз, пока вам не станет удобно.
2. Перемещайте гибкий штатив микрофона вверх-вниз и по направлению к себе либо от себя, пока он не займет положение, оптимальное с точки зрения качества звучания.
3. Когда микрофон не используется, просто отверните держатель в сторону.

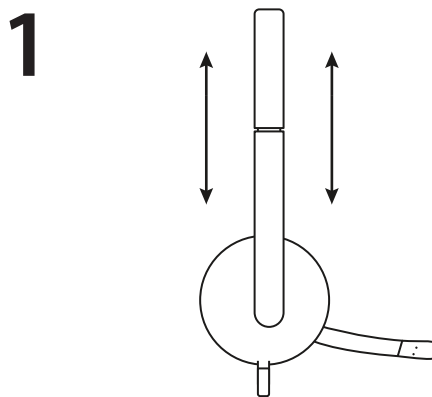

2

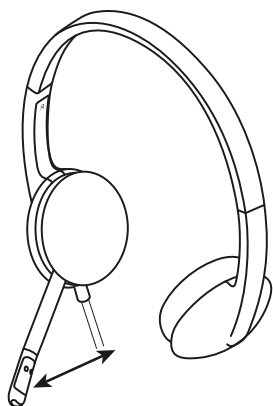

3

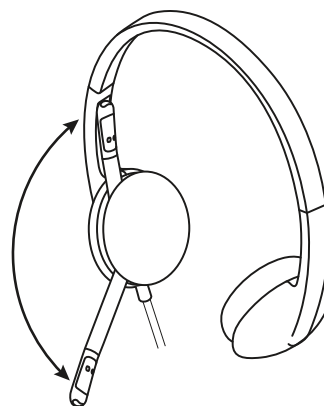

www.logitech.com/support/H340

OPIS URZĄDZENIA

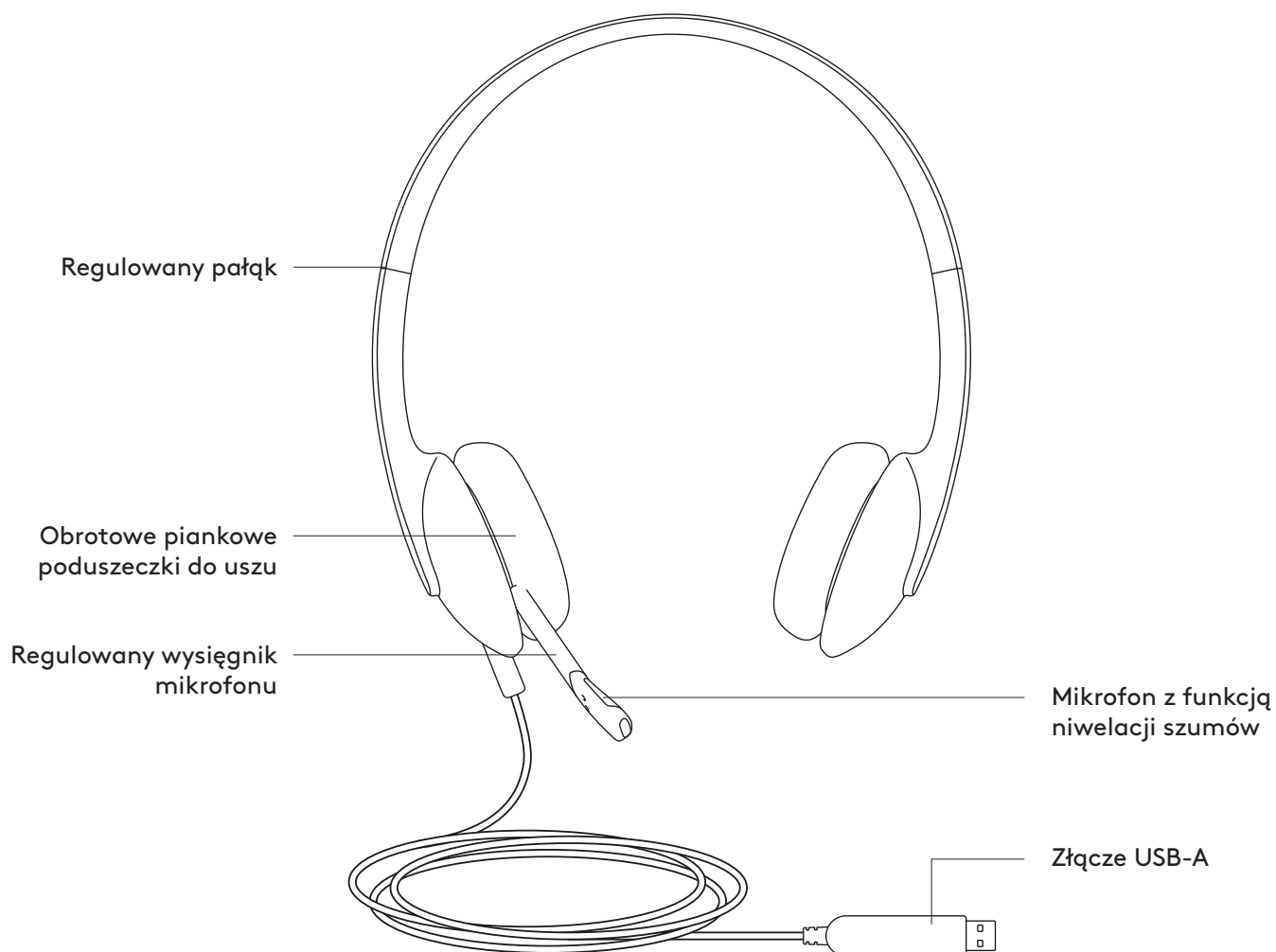

PODŁĄCZANIE ZESTAWU SŁUCHAWKOWEGO

Podłącz złącze USB-A do portu USB komputera.

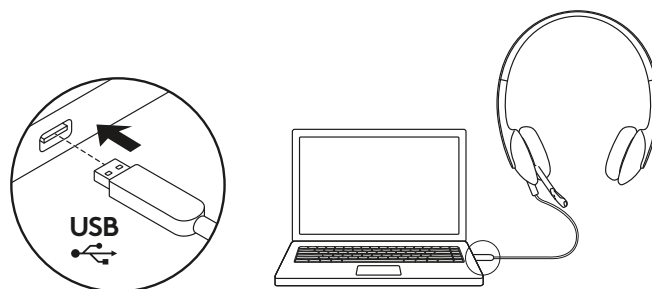

DOPASOWYWANIE ZESTAWU SŁUCHAWKOWEGO

1. Aby wyregulować rozmiar zestawu słuchawkowego, przesuwaj pałąk w górę lub w dół do momentu wygodnego dopasowania.
2. Przesuwaj elastyczny wysięgnik mikrofonu w górę lub w dół i do lub od siebie do momentu, aż będzie na poziomie ust, co zapewni lepsze przechwytywanie dźwięku.
3. Gdy wysięgnik mikrofonu nie jest używany, wystarczy go odsunąć.

1

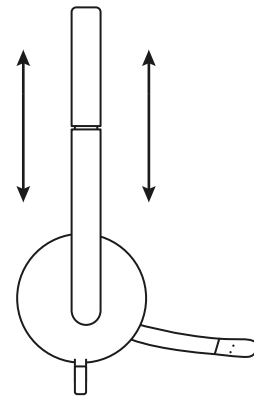

2

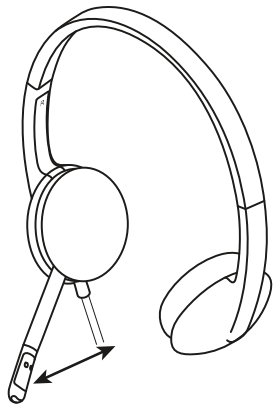

3

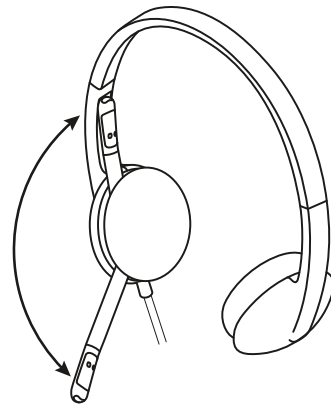

www.logitech.com/support/H340

A TERMÉK ISMERTETÉSE

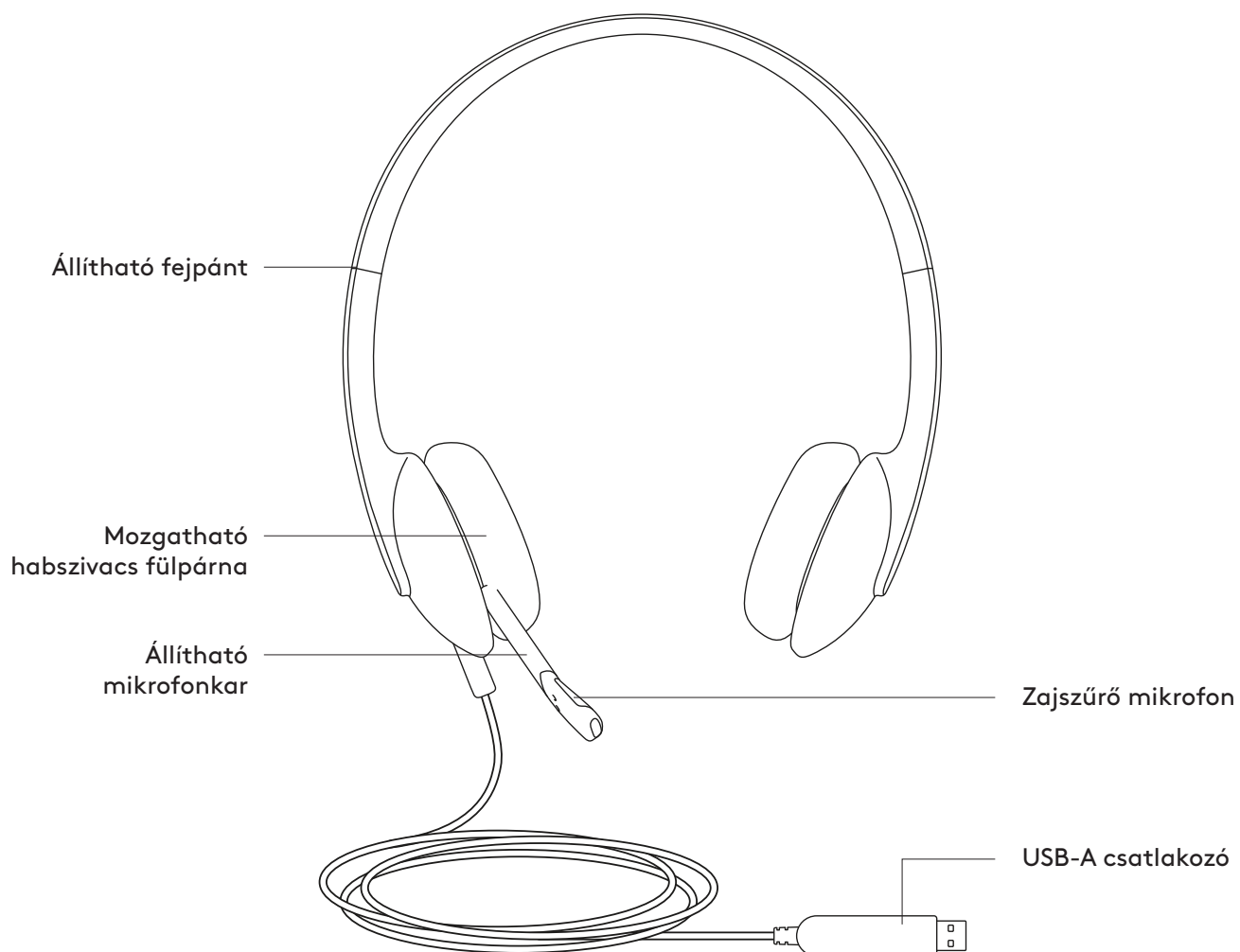

A MIKROFONOS FEJHALLGATÓ CSATLAKOZTATÁSA

Dugja az USB-A csatlakozót a számítógép USB-portjába.

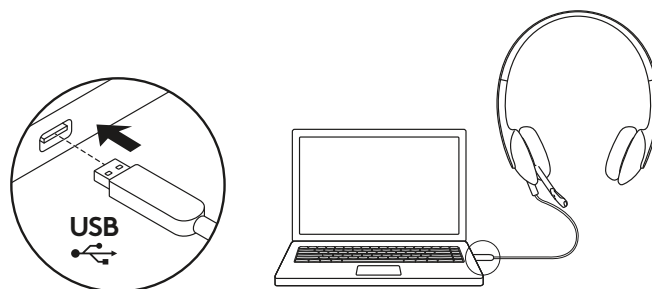

A MIKROFONOS FEJHALLGATÓ MÉRETRE ÁLLÍTÁSA

1. A mikrofonos fejhallgató méretének beállításához mozgassa fel-le a fejpántot, amíg az kényelmes nem lesz.
2. A jobb hangérzékeléshez mozgassa fel-le és előre-hátra a rugalmas mikrofonkart, amíg a szája elé nem kerül.
3. A mikrofonkar felhajtható, amikor éppen nem használja.

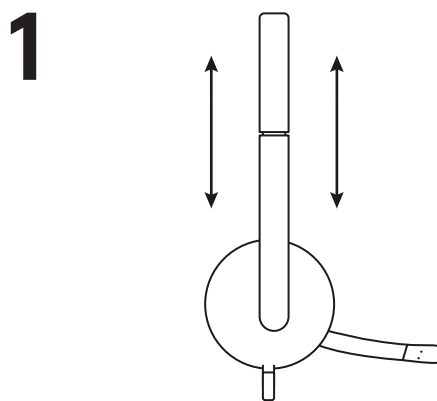

2

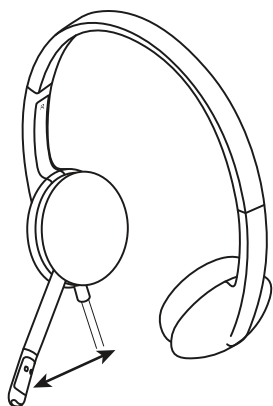

3

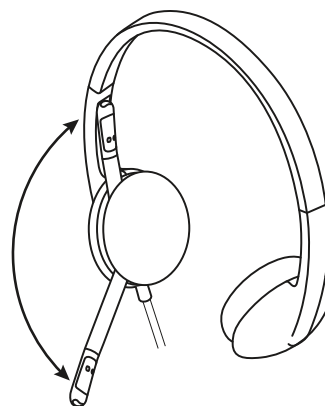

www.logitech.com/support/H340

POPIS PRODUKTU

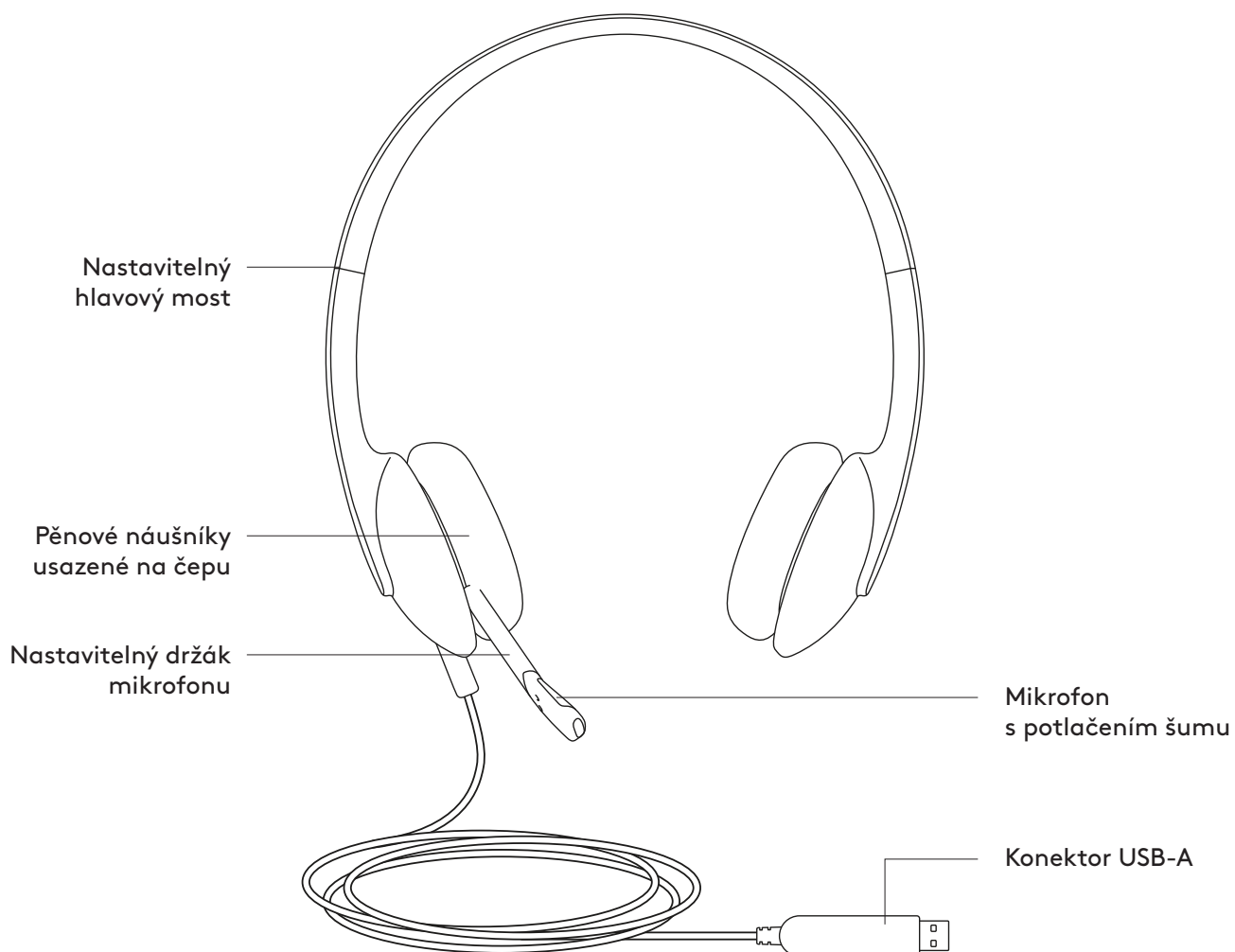

PŘIPOJENÍ NÁHLAVNÍ SOUPRAVY

Připojte konektor USB-A k portu USB v počítači.

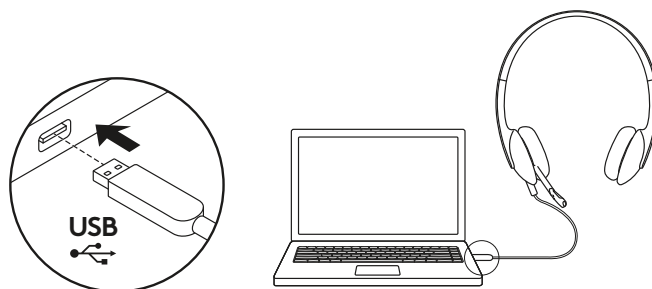

USAZENÍ NÁHLAVNÍ SOUPRAVY

1. Nastavte si velikost náhlavní soupravy posouváním hlavového mostu nahoru a dolů, dokud vám pohodlně nepadne.
2. Nastavte si flexibilní držák mikrofonu pohyby nahoru, dolů, k sobě a od sebe tak, aby byl v rovině s vašimi ústy pro lepší snímání hlasu.
3. Když držák mikrofonu nepoužíváte, stačí jej odklopit stranou.

1

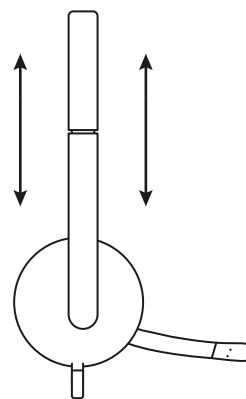

2

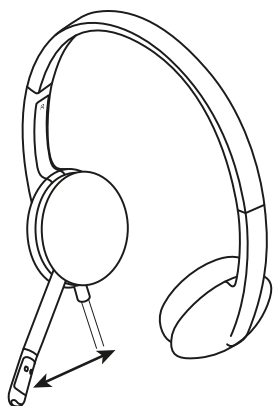

3

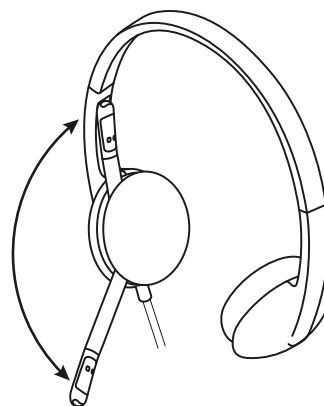

www.logitech.com/support/H340

POPIS PRODUKTU

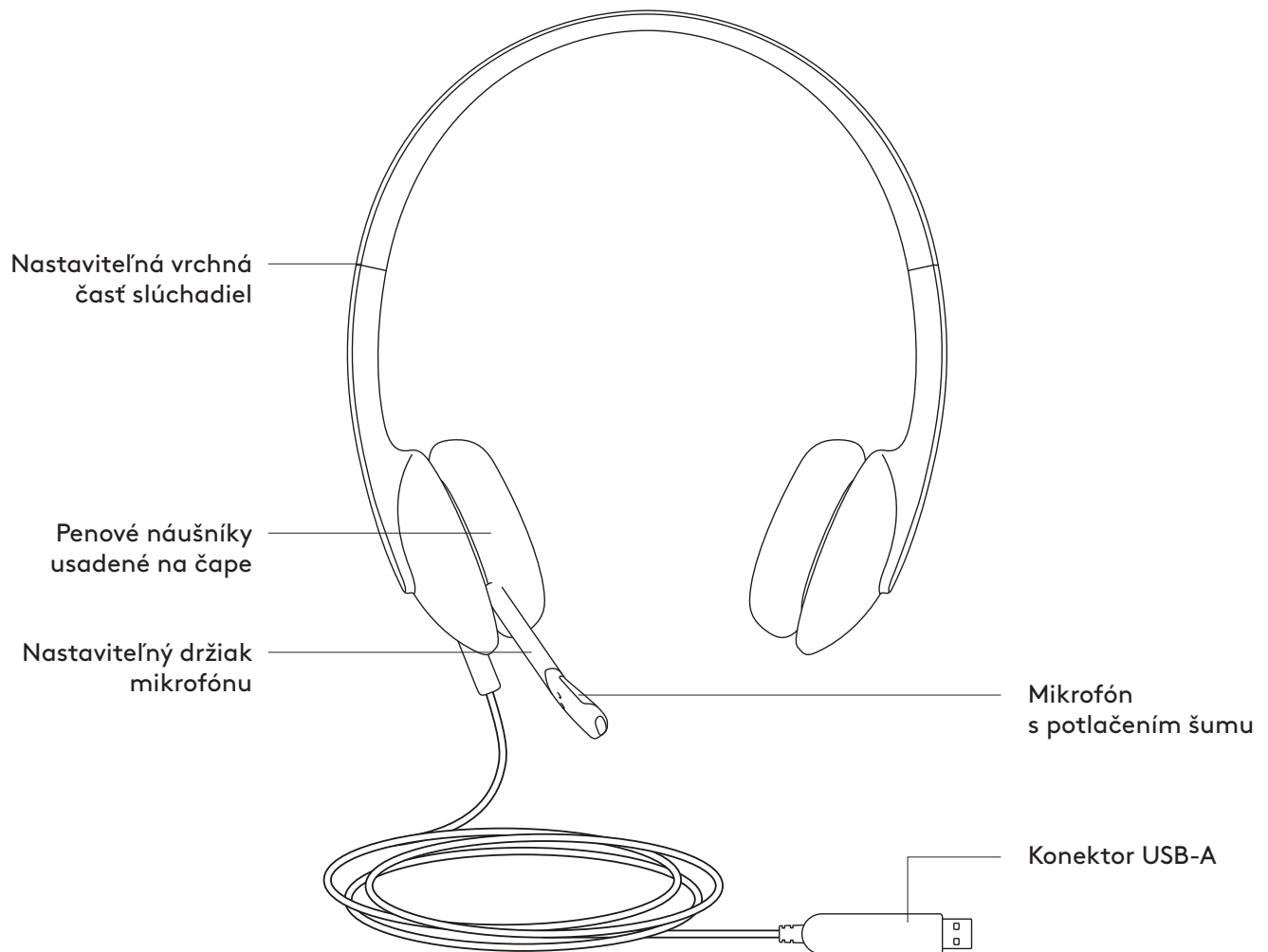

PRIPOJENIE NÁHLAVNEJ SÚPRAVY

Pripojte konektor USB-A k portu USB v počítači.

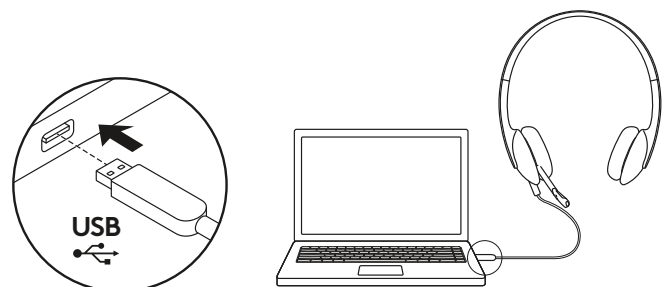

USADENIE NÁHLAVNEJ SÚPRAVY

1. Nastavte si veľkosť náhlavnej súpravy posúvaním hlavového mosta nahor a nadol, kým vám pohodlne nepadne.
2. Nastavte si flexibilný držiak mikrofónu pohybmi nahor, nadol, k sebe a od seba tak, aby bol v rovine s vašimi ústami pre lepšie snímanie hlasu.
3. Keď držiak mikrofónu nepoužívate, stačí ho odklopiť nabok.

1

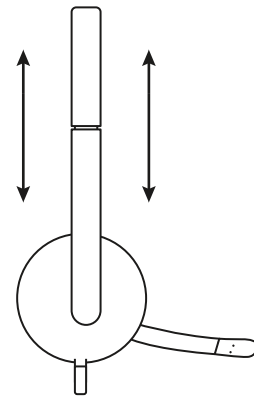

2

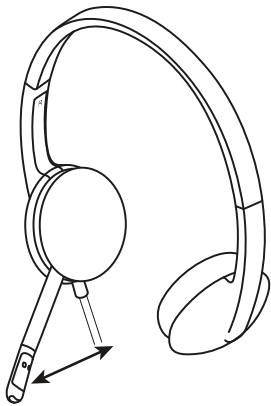

3

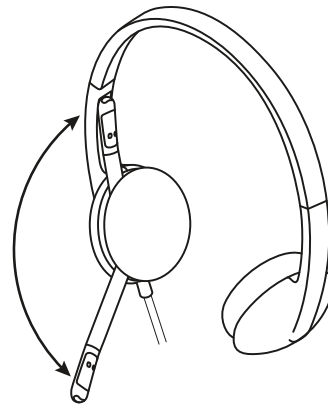

www.logitech.com/support/H340

ОЗНАЙОМЛЕННЯ З ПРОДУКТОМ

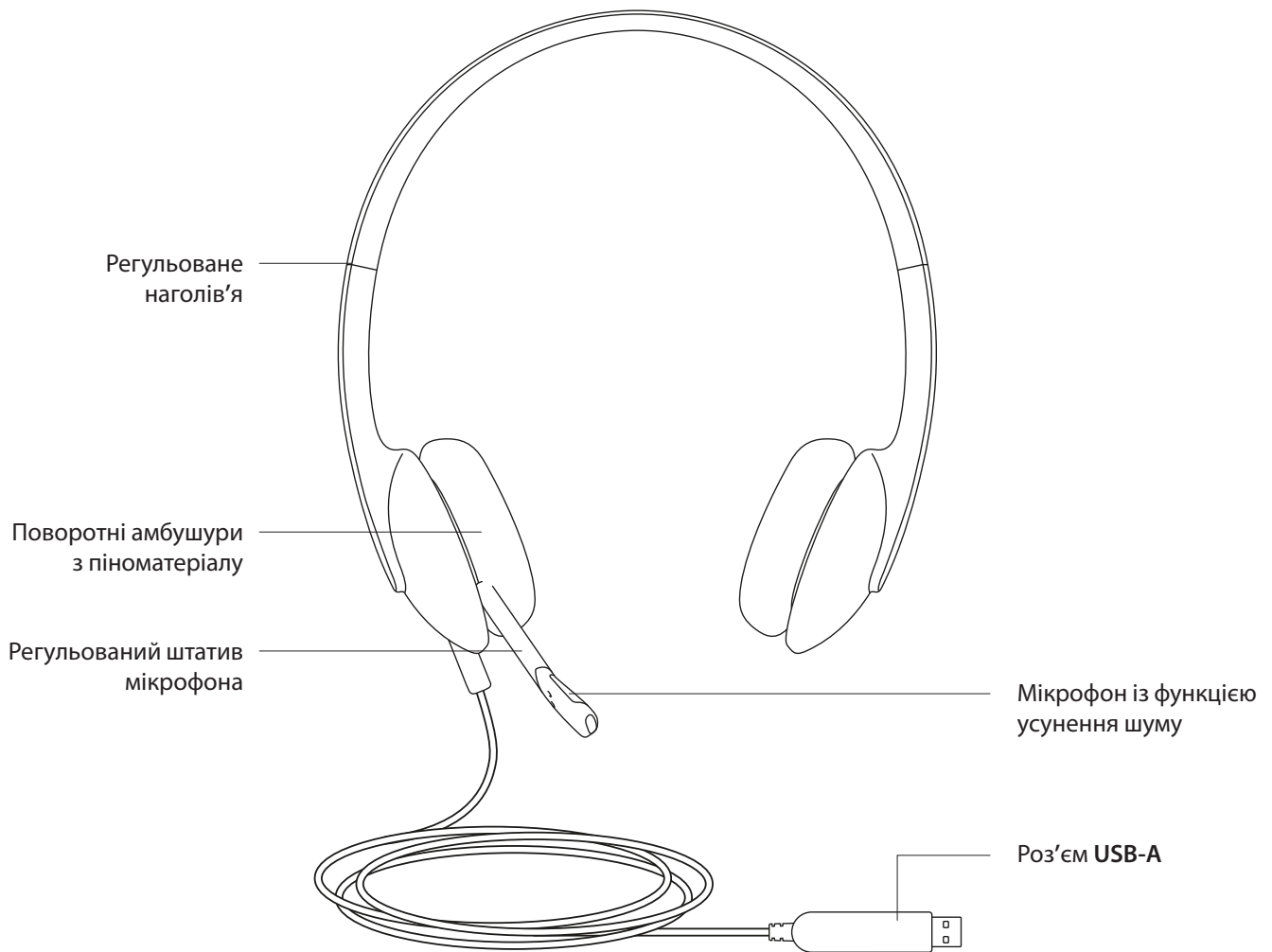

ПІДКЛЮЧЕННЯ ГАРНІТУРИ

Вставте роз'єм USB-A у USB-порт комп'ютера.



ПОСАДКА ГАРНІТУРИ

1. Щоб визначити потрібний розмір гарнітури, рухайте наголів'я вгору-вниз, поки вам не стане зручно.
2. Переміщуйте гнучкий штатив мікрофона угору-вниз і в напрямку до себе та від себе, поки він не набуде положення, в якому забезпечуватиме оптимальну якість звучання.
3. Коли мікрофон не використовується, його можна повернути вбік.

1

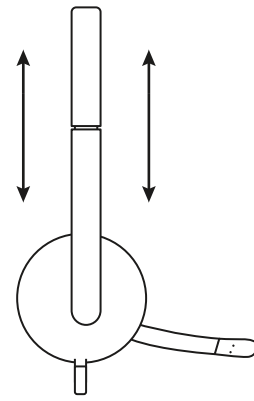

2

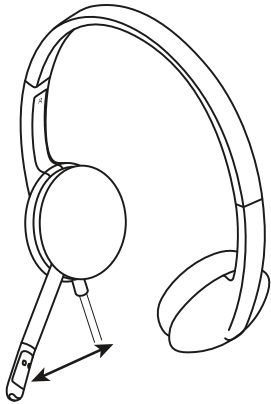

3

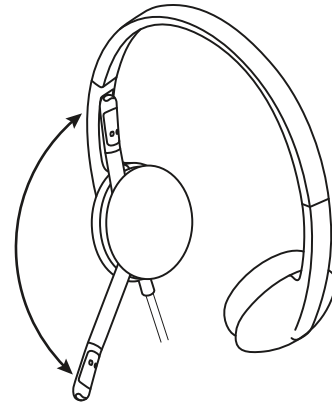

www.logitech.com/support/H340

TOOTE TUTVUSTUS

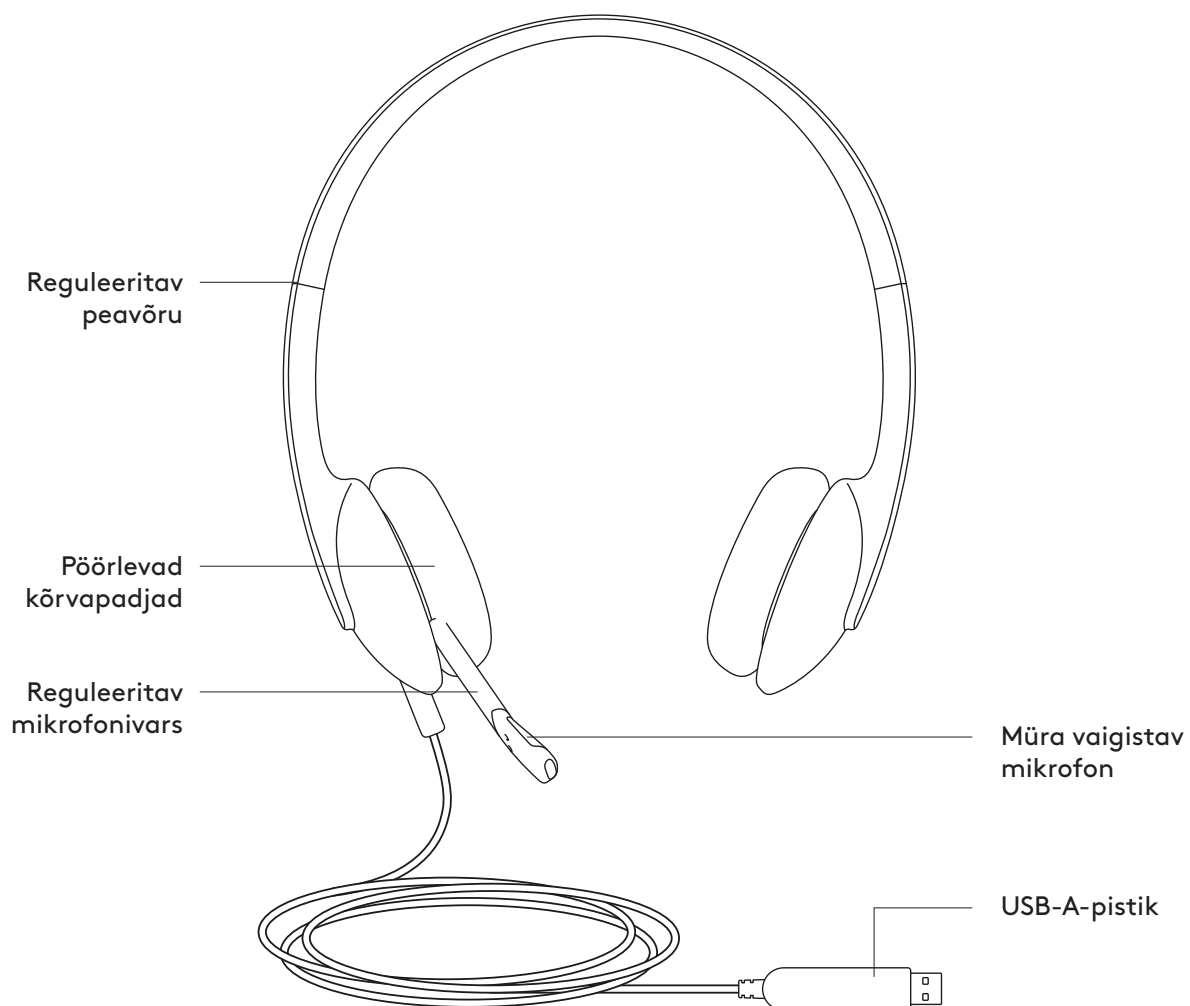

PEAKOMPLEKTI ÜHENDAMINE

Ühendage USB-A-konnektor arvuti USB-porti.

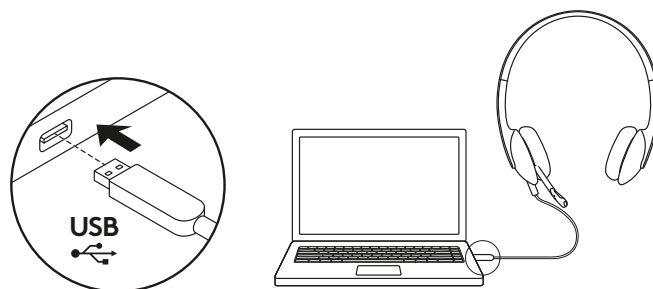

PEAKOMPLEKTI PÄHESOBIVUS

1. Peakomplekti suuruse reguleerimiseks liigutage seda üles ja alla, kuni leiate mugavaima asendi.
2. Parima häälesalvestuse saavutamiseks liigutage mikrofonivart üles või alla, kuni see on suuga sama kõrgel.
3. Kui te mikrofoni ei kasuta, keerake see eest ära.

1

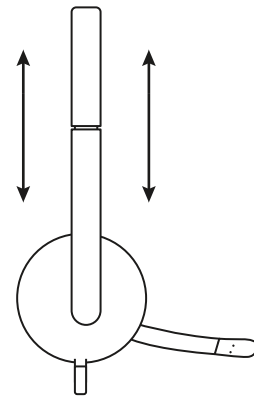

2

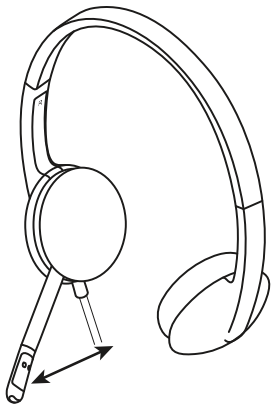

3

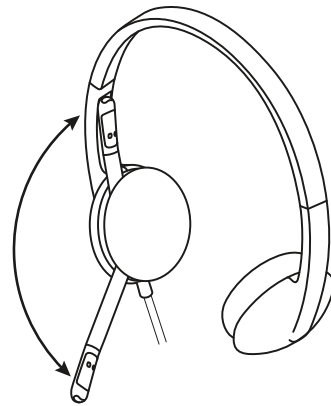

www.logitech.com/support/H340

PĀRZINIET SAVU IERĪCI

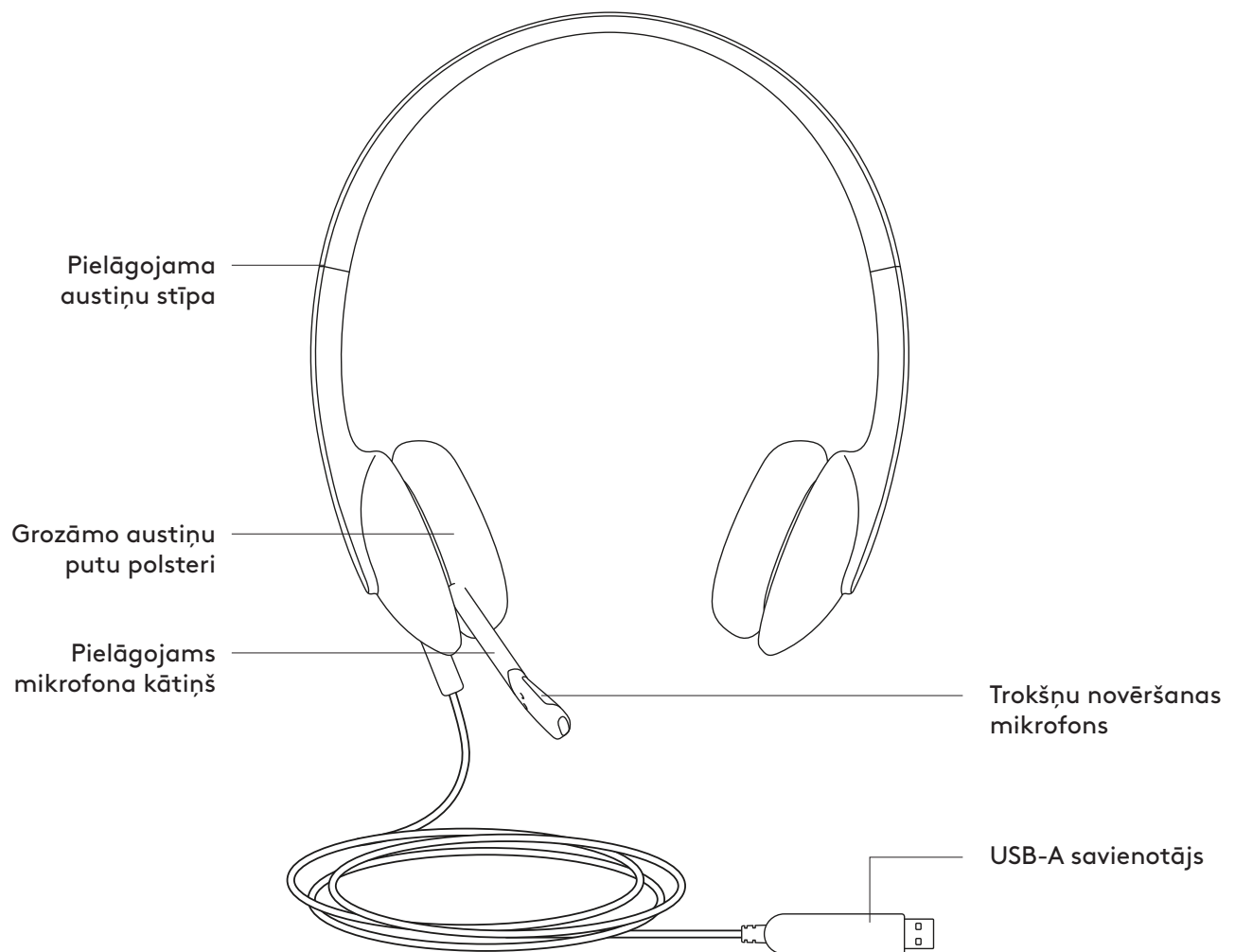

AUSTIŅU PIEVIENOŠANA

Iespraudiet USB-A savienotāju datora USB pieslēgvietā.



AUSTIŅU REGULĒŠANA

1. Lai noregulētu austiņu izmēru, pārvietojiet austiņu stīpu uz augšu vai leju, līdz tā ērti der uz galvas.
2. Pārvietojiet izvelkamo mikrofona kātiņu uz augšu vai uz leju un ievielciet vai izvelciet to, līdz tas ir vienā līmenī ar jūsu muti, šādi nodrošinot labāku skaņas uztveršanu.
3. Kad neizmantojat mikrofona, tā kātiņu var pacelt uz augšu, lai tas netraucētu.

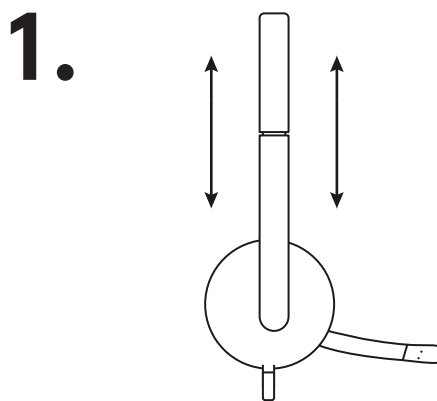

2.

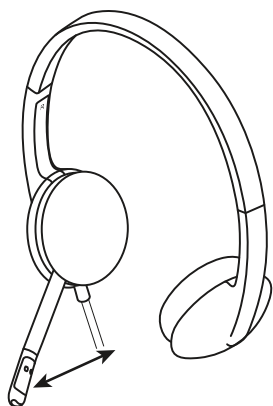

3.

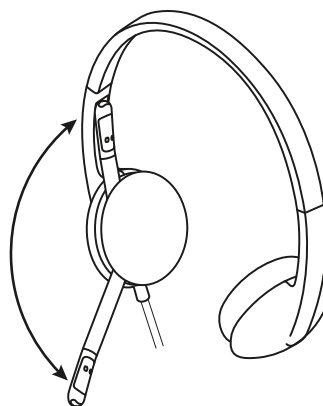

www.logitech.com/support/H340

SUSIPAŽINKITE SU SAVO PRODUKTU

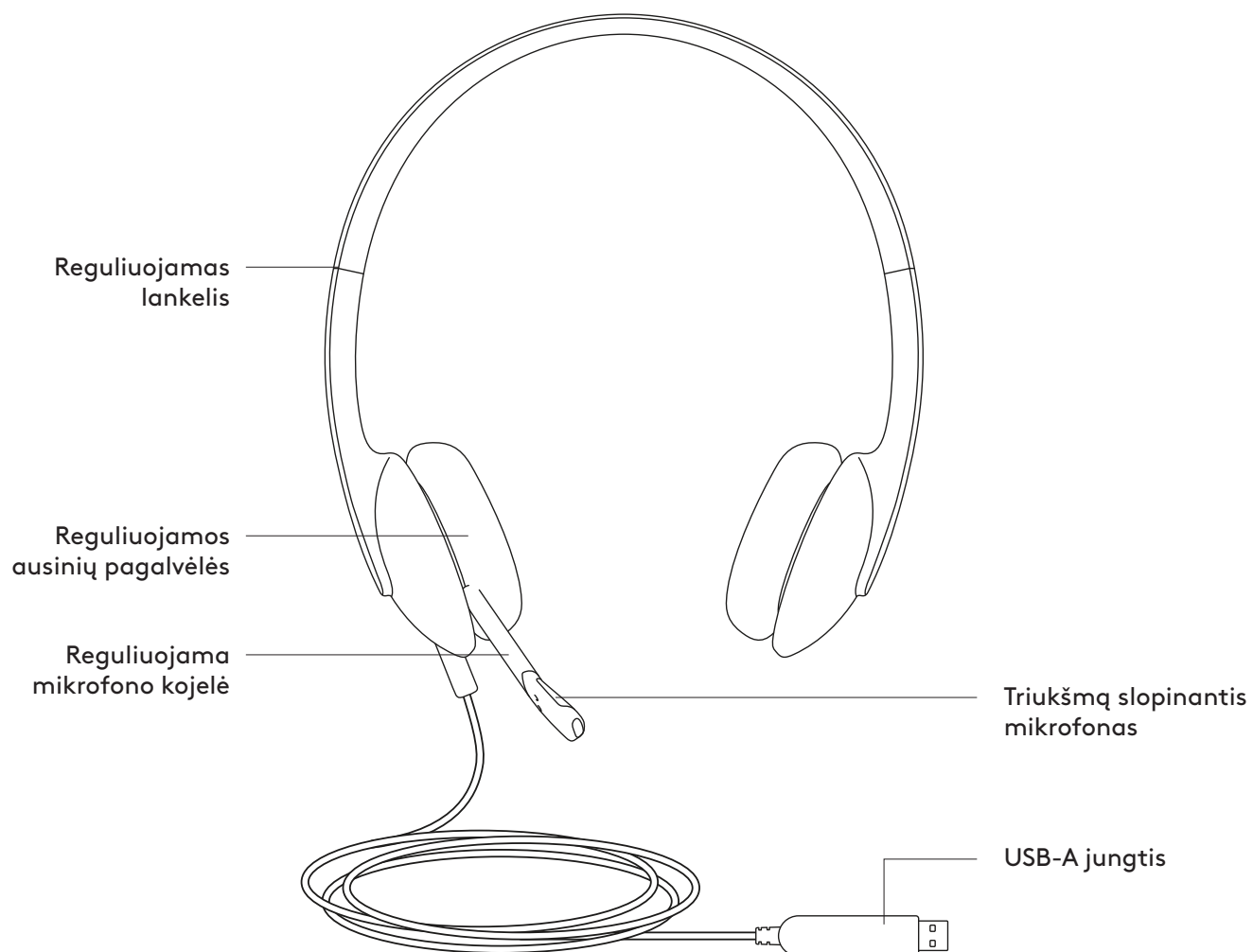

AUSINIŲ PRIJUNGIMAS

Įkiškite USB-A jungtį į kompiuterio USB prievadą.

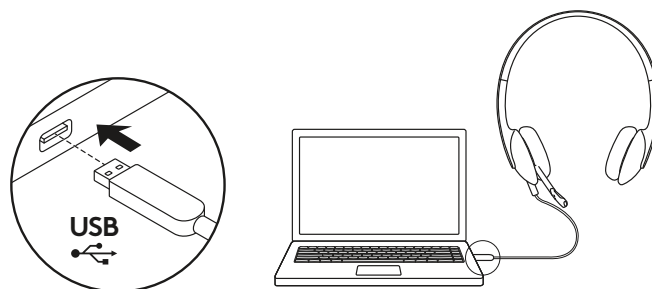

AUSINIŲ SUREGULIAVIMAS

1. Sureguliuokite galvos juostos dydį judindami galvos juostą į viršų ir apačią, kol patogiai tiks.
2. Judinkite lanksčią mikrofono strėlę į viršų ar apačią, kol ji bus sulig jūsų burna, kad garsas būtų geriau fiksuojamas.
3. Kai nenaudojate, strėlę nusukite toliau.

1

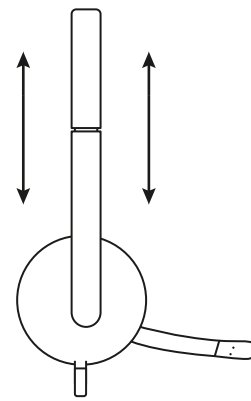

2

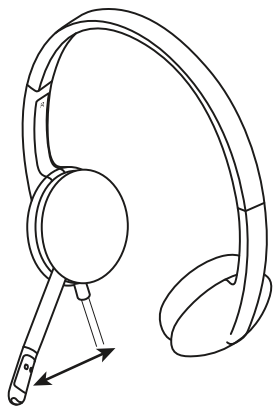

3

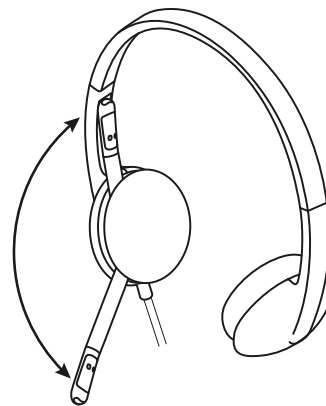

www.logitech.com/support/H340

ЗАПОЗНАЙТЕ СЕ СЪС СВОЯ ПРОДУКТ

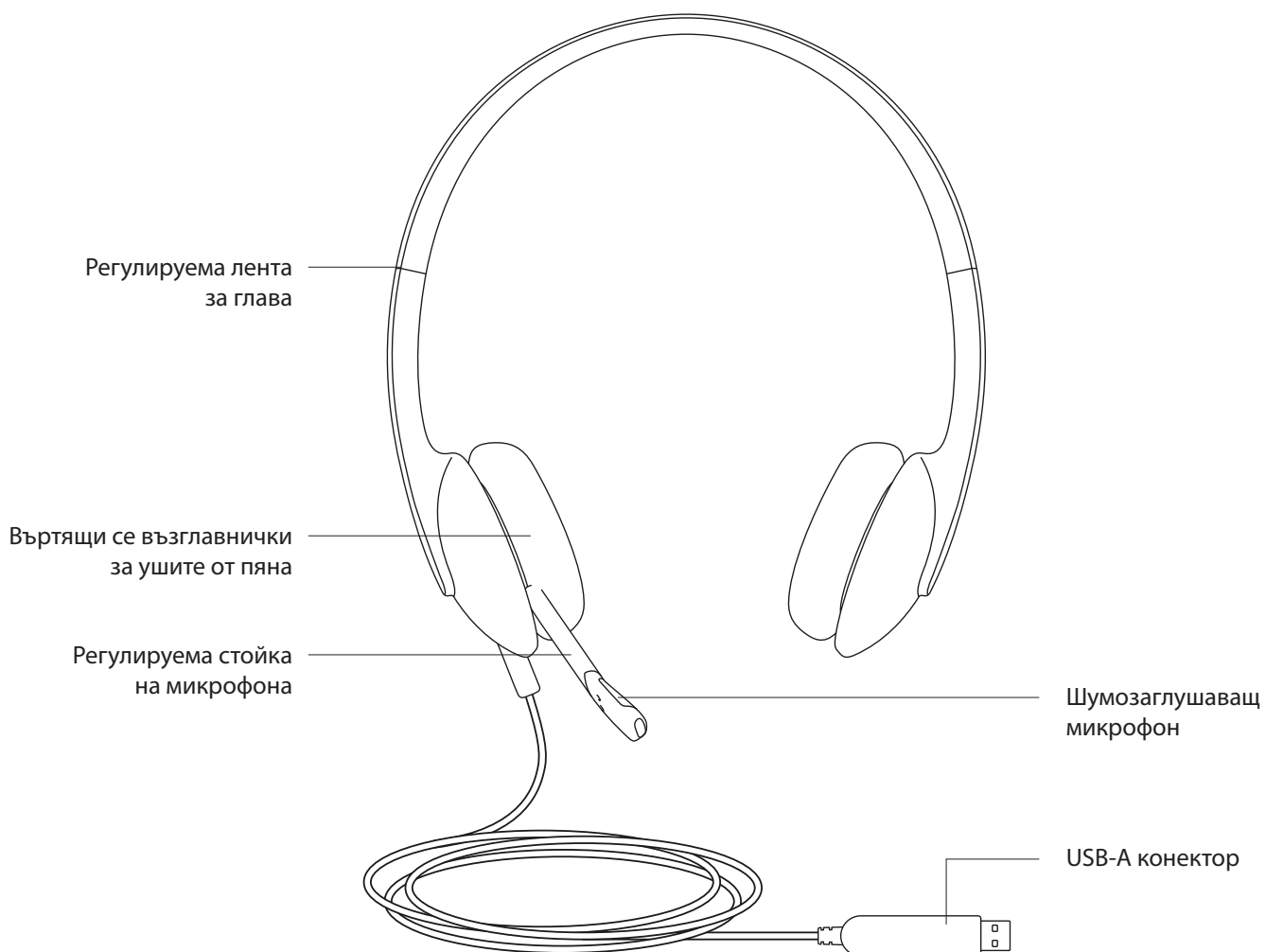

СВЪРЗВАНЕ НА СЛУШАЛКИТЕ

Включете USB-A конектора към USB порта на компютъра.

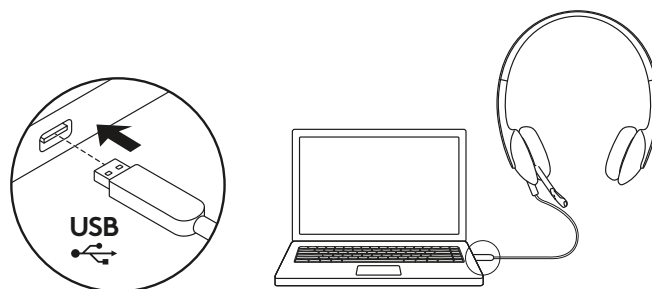

НАПАСВАНЕ НА СЛУШАЛКИТЕ

1. За да регулирате размера на слушалките, движете лентата за глава нагоре и надолу, докато пасне удобно.
2. Движете гъвкавата стойка на микрофона нагоре или надолу и навътре или навън, докато не е на нивото на устата ви за по-добро улавяне на гласа.
3. Когато не се използва, стойката на микрофона може да се прибере.

1

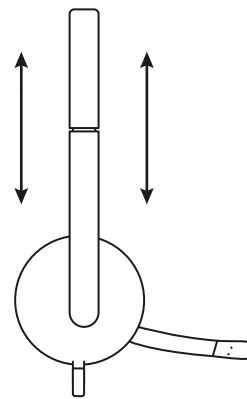

2

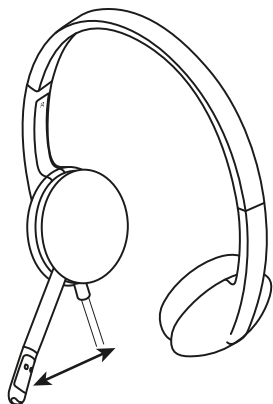

3

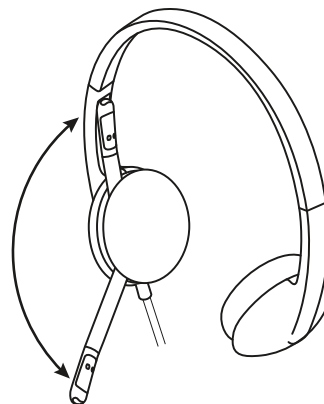

www.logitech.com/support/H340

UPOZNAJTE SVOJ UREĐAJ

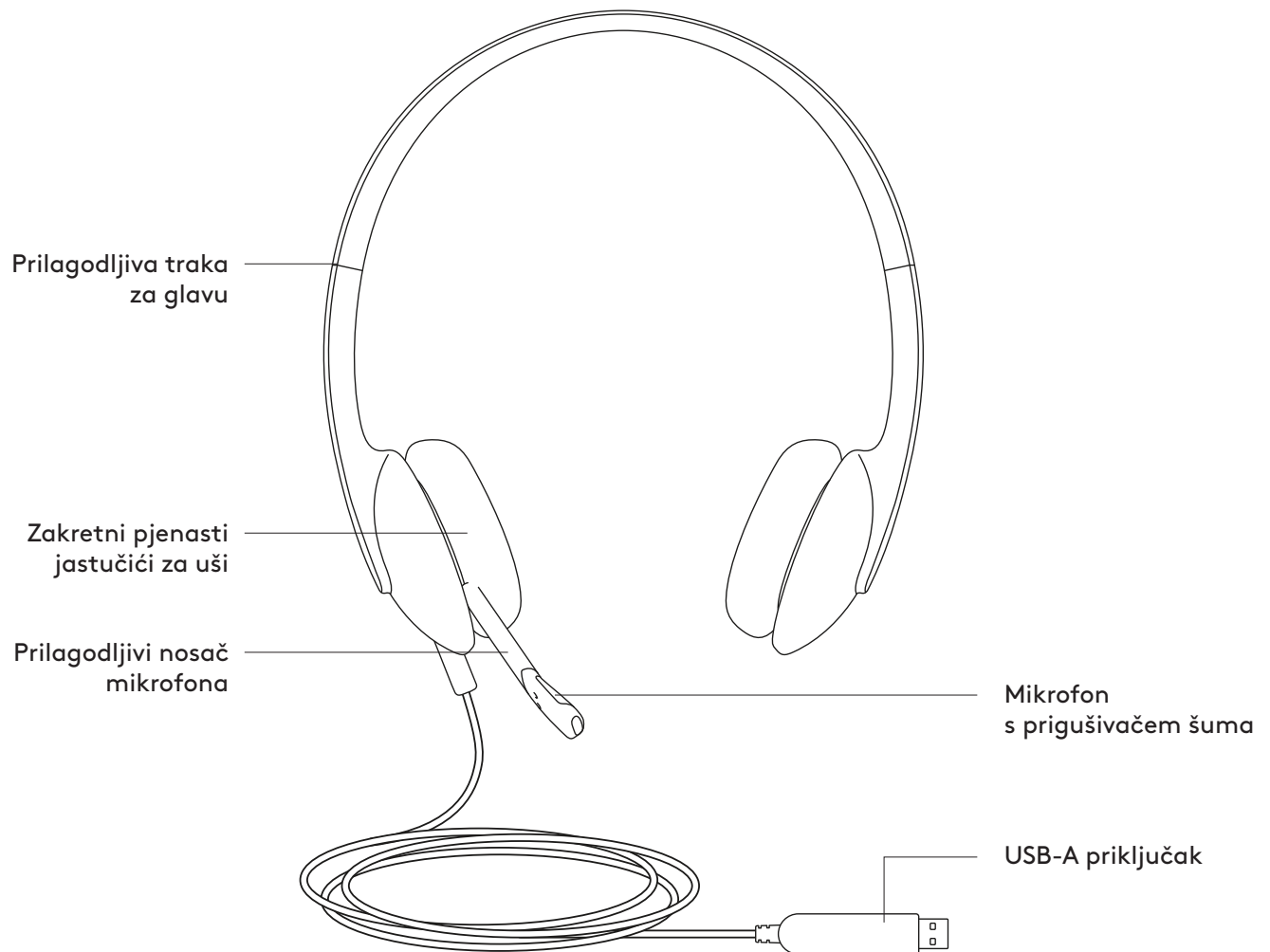

PRIKLJUČIVANJE SLUŠALICA

Ukopčajte USB-A priključak u USB priključnicu na računalu.

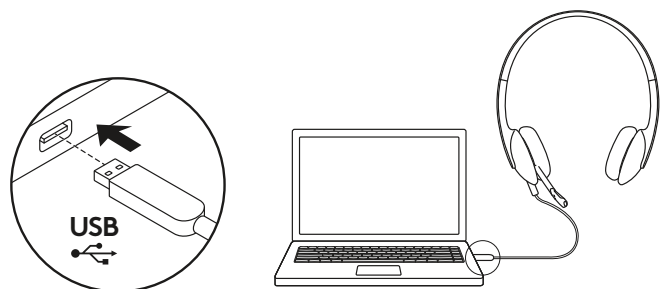

NAMJEŠTANJE SLUŠALICA

1. Ako želite prilagoditi veličinu slušalica, pomičite traku za glavu gore i dolje da vam udobno prisjedaju.
2. Pomaknite savitljivi nosač mikrofona gore ili dolje i naprijed ili nazad kako bi bio u ravni s vašim ustima za bolje hvatanje glasa.
3. Nosač se može odmaknuti da vam ne smeta kada ga ne upotrebljavate.

1

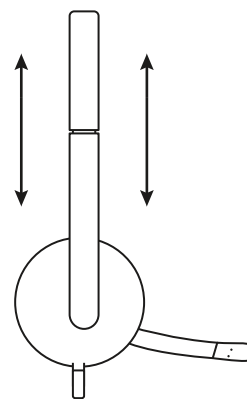

2

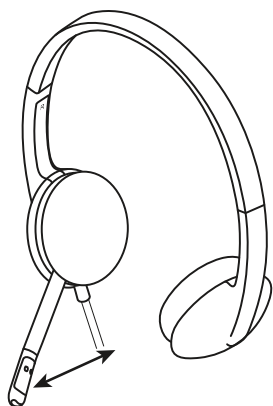

3

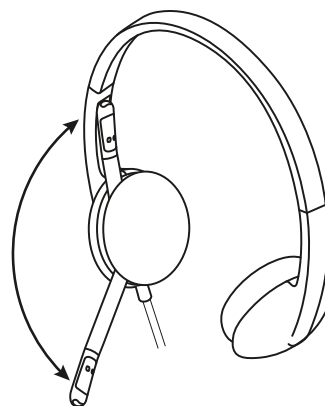

www.logitech.com/support/H340

UPOZNAJTE SVOJ PROIZVOD

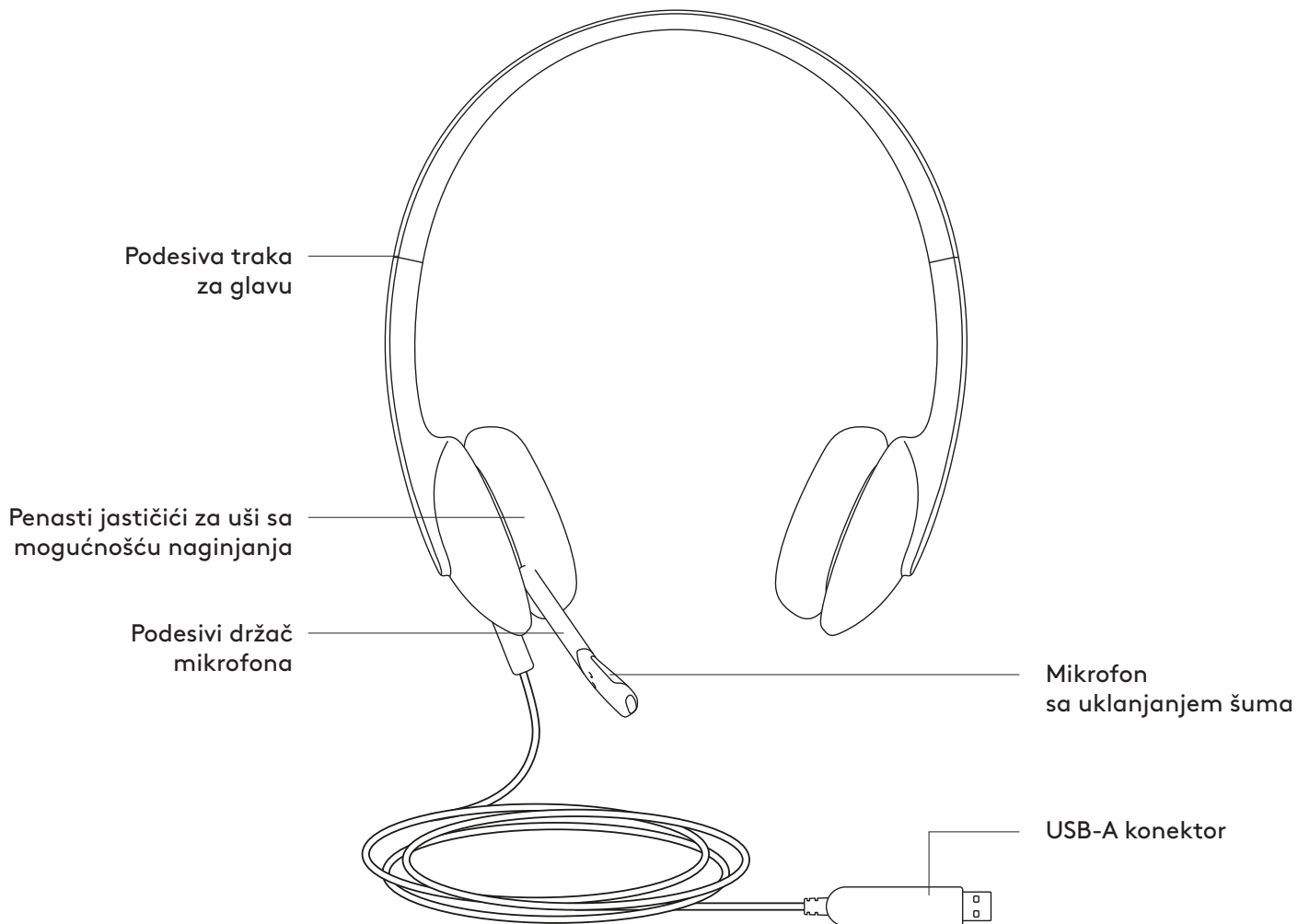

POVEZIVANJE SLUŠALICA

Priključite USB-A konektor u USB port na računaru.

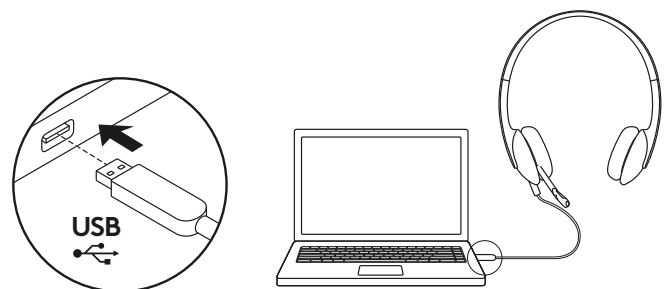

PRILAGOĐAVANJE SLUŠALICA

1. Da biste podesili veličinu slušalica, pomerajte traku za glavu gore-dole dok je ne namestite udobno.
2. Pomerajte fleksibilni držač mikrofona gore-dole i napred-nazad dok ne bude u nivou vaših usta, za bolje snimanje zvuka.
3. Držač možete da sklonite kada ga ne koristite.

1

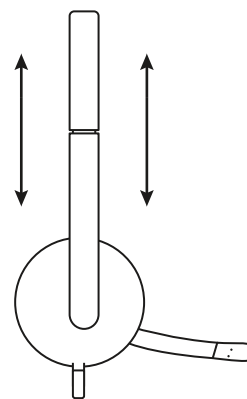

2

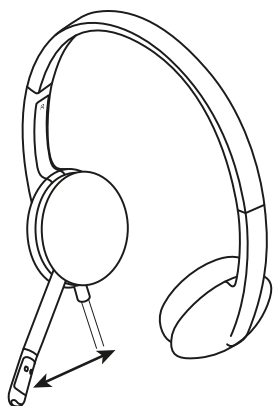

3

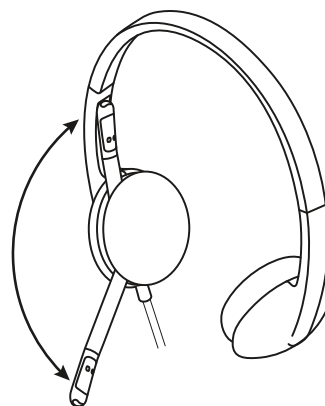

www.logitech.com/support/H340

SPOZNAJTE IZDELEK

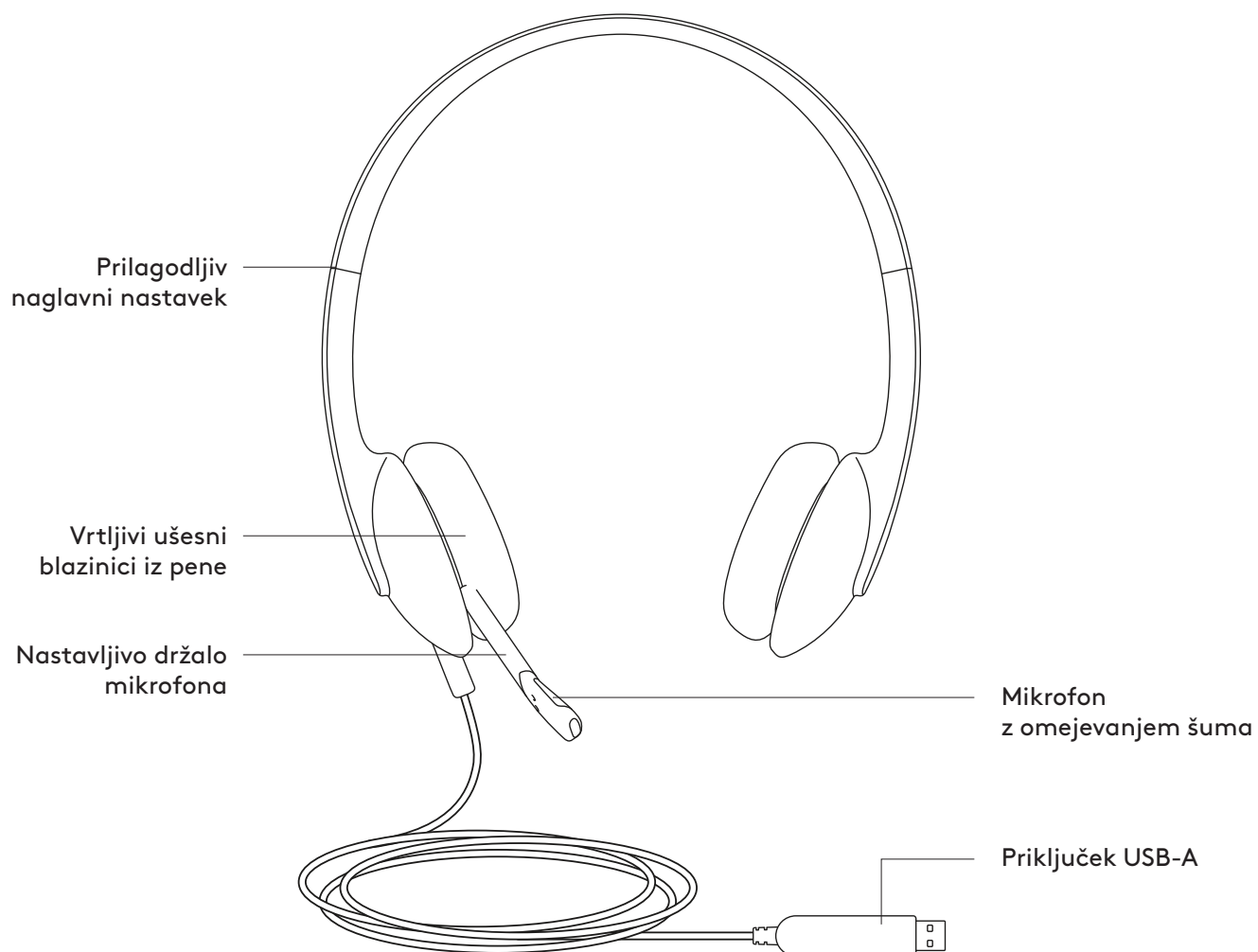

PRIKLJUČITEV SLUŠALK

Priključek USB-A priključite v vrata USB na računalniku.

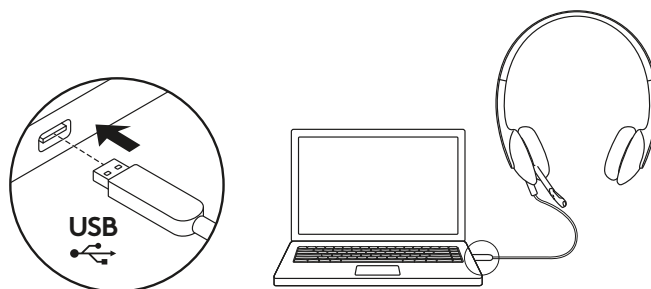

NASTAVITEV SLUŠALK

1. Da prilagodite velikost slušalk, naglavni nastavek pomikajte navzgor ali navzdol, dokler se udobno ne prilega.
2. Da zagotovite boljši zajem glasu, premično držalo mikrofona pomaknite navzgor ali navzdol, tako da je postavljen v višini ust.
3. Ko mikrofona ne uporabljate, lahko držalo zložite, da vam ne bo v napoto.

1

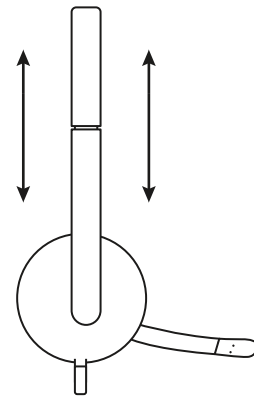

2

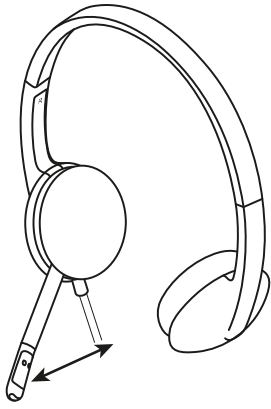

3

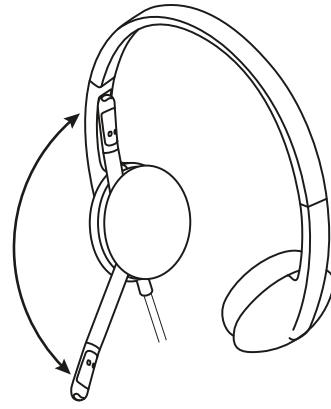

www.logitech.com/support/H340

FAMILIARIZAȚI-VĂ CU PRODUSUL

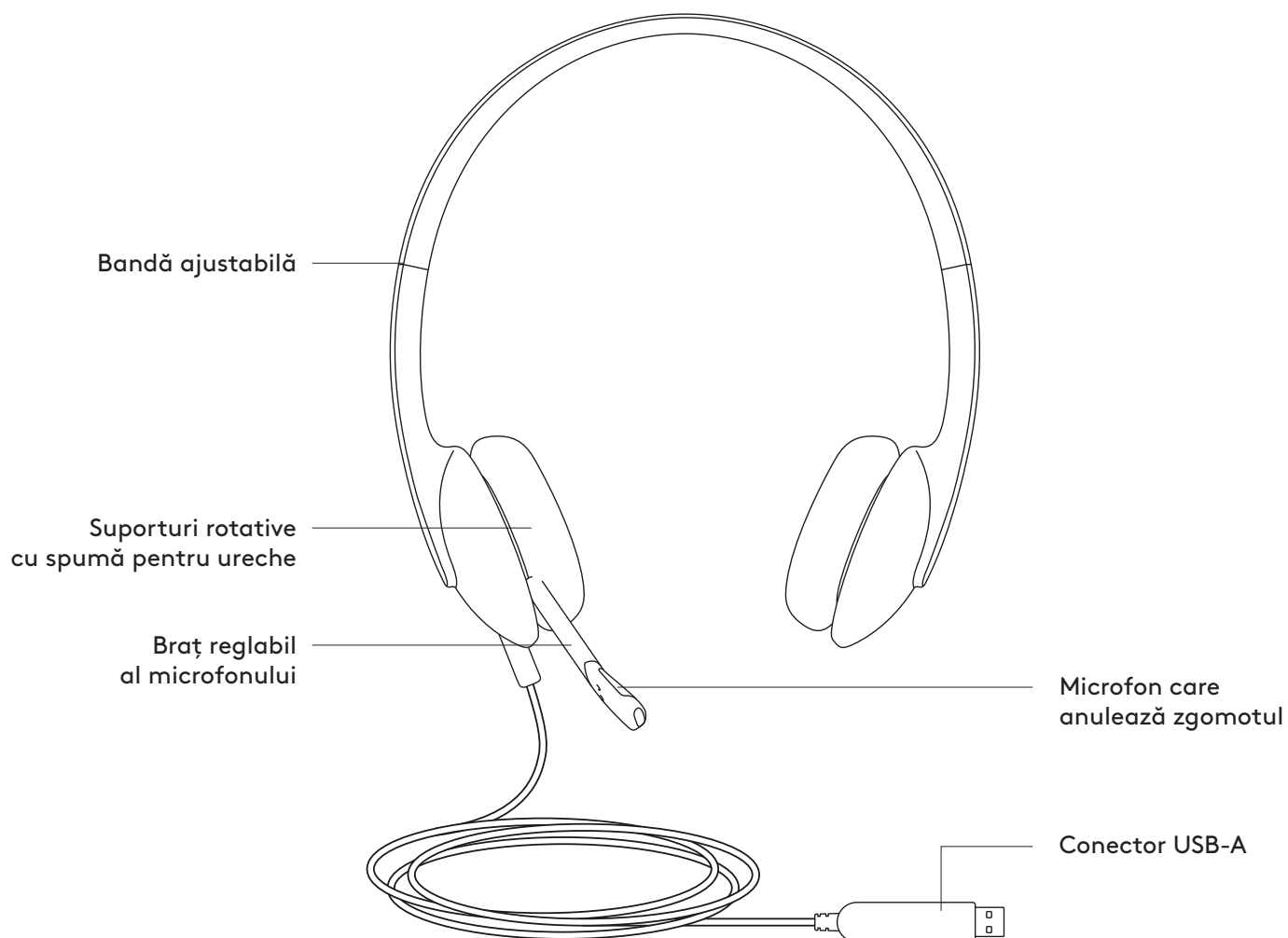

CONECTAREA CĂȘTILOR

Conectați conectorul USB-A la un port USB al computerului.

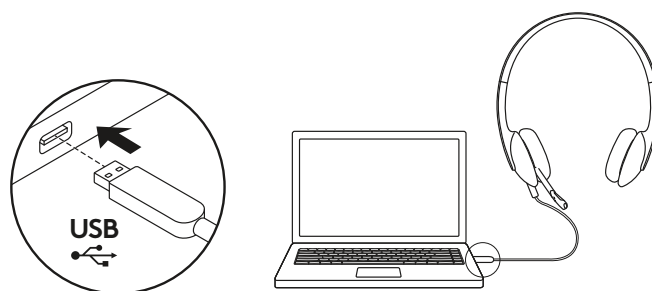

AJUSTAREA CĂȘTILOR

1. Pentru a ajusta dimensiunea căștilor, deplasați-le în sus și în jos până când se poziționează confortabil.
2. Mișcați brațul microfonului flexibil în sus sau în jos până când ajunge în dreptul gurii pentru a capta mai bine vocea.
3. Brațul microfonului poate fi îndepărtat când nu îl folosiți.

1

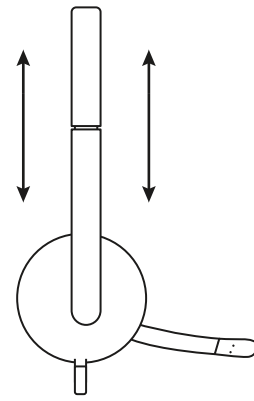

2

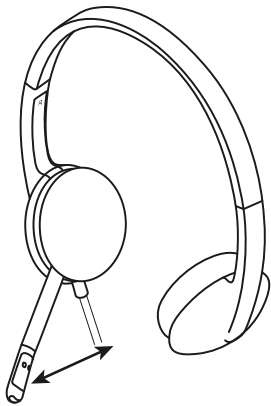

3

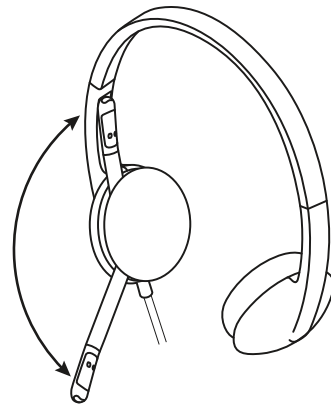

www.logitech.com/support/H340

ÜRÜNÜNÜZÜ TANIYIN

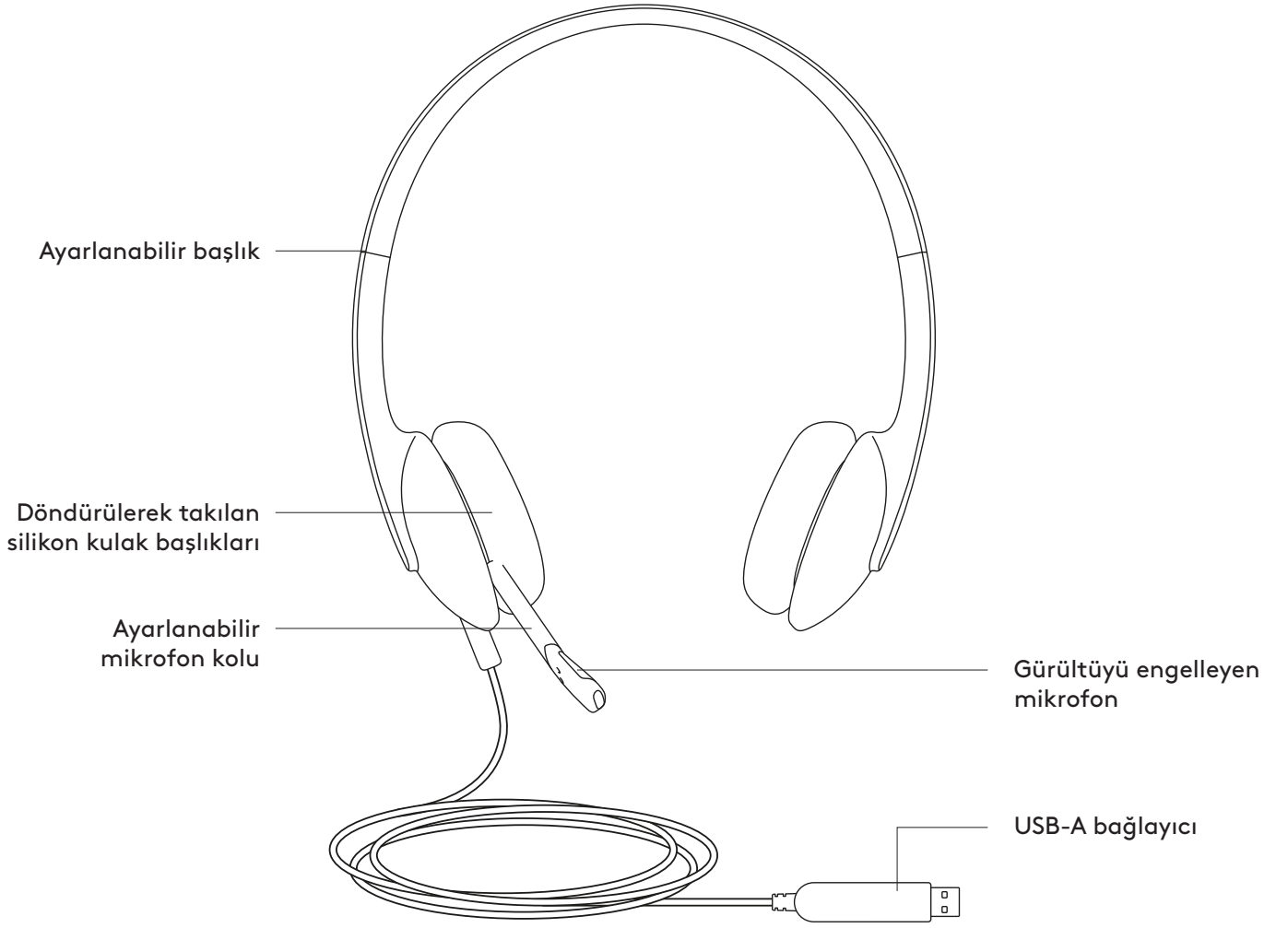

KULAKLIĞI BAĞLAMA

USB-A bağlayıcıyı bilgisayarın USB bağlantı noktasına takın.

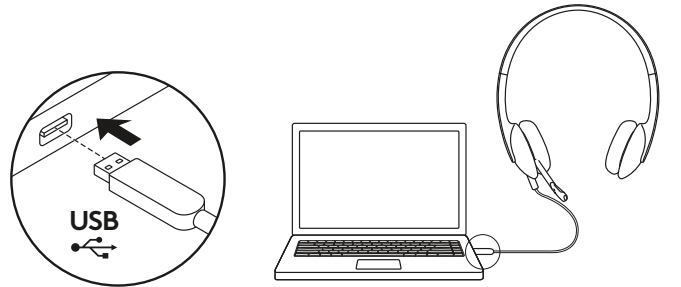

KULAKLIĐI YERLEŐTİRME

1. Kulaklık boyutunu ayarlamak için, başlıđı aŐađı ve yukarı oynatıp rahat Őekilde oturacađı konumu bulun.
2. Daha iyi ses yakalayabilmesi için esnek mikrofon kolunu aŐađı ve yukarı oynatarak ađzunuzun seviyesine getirin.
3. Mikrofon kolu, kullanmadıđınız zamanlarda önünüzü kapatmaması için gizlenebilir.

1

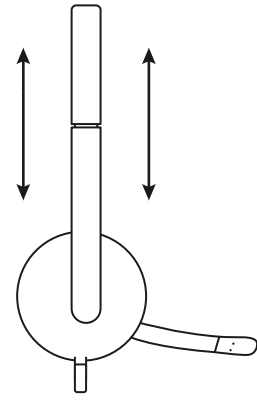

2

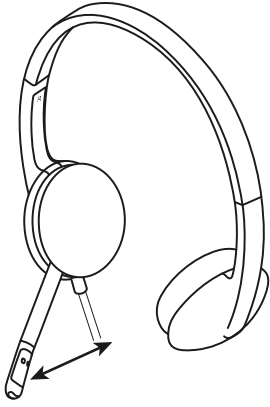

3

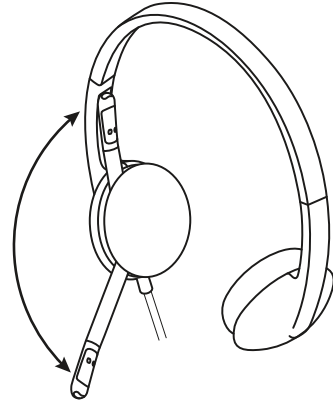

www.logitech.com/support/H340

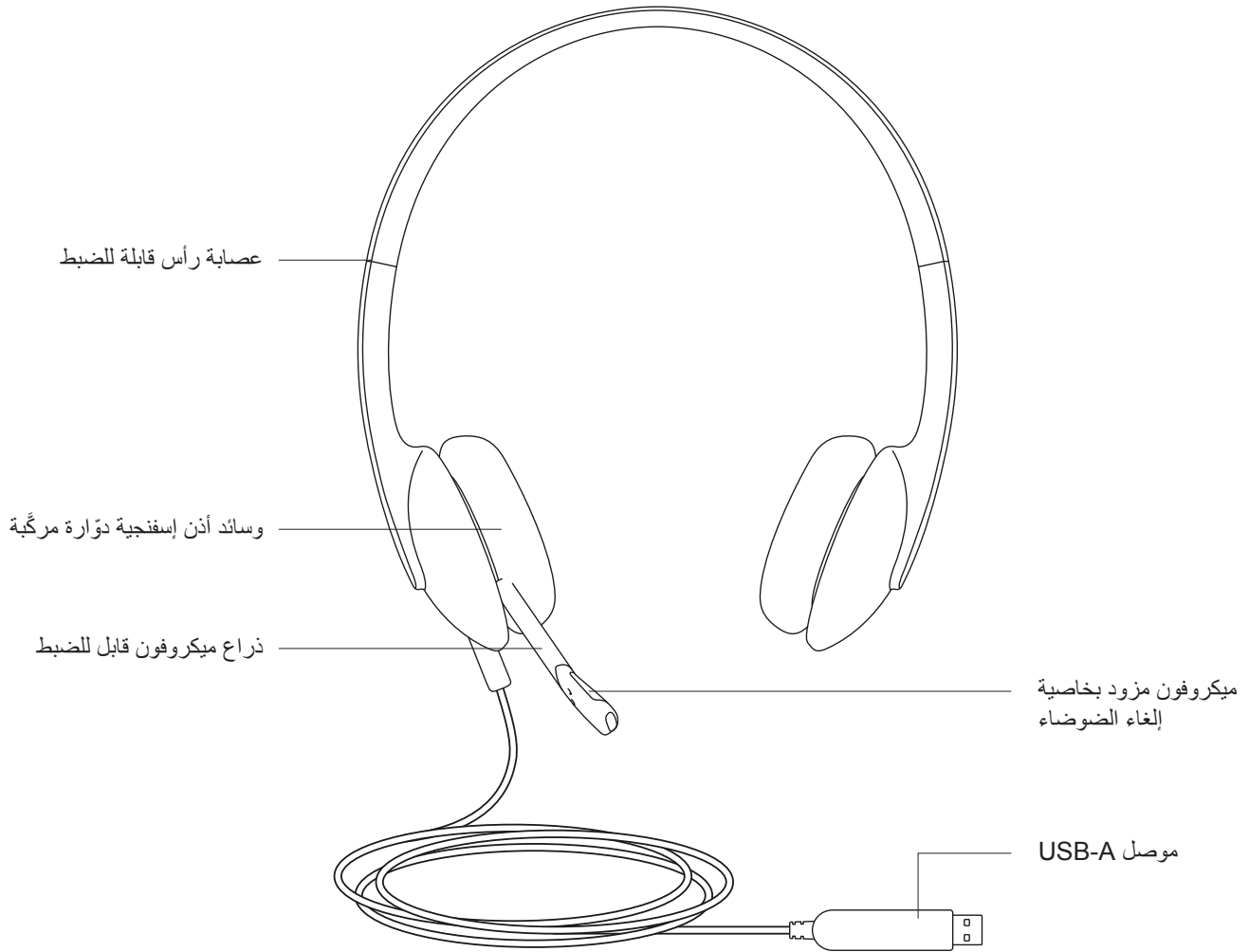

توصيل سماعة الرأس
وصل موصل USB-A بمنفذ USB بالكمبيوتر.

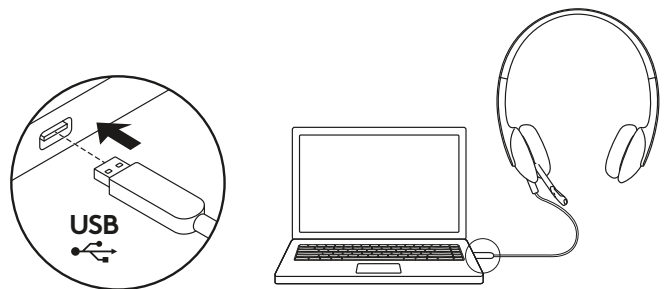

تكييف سماعة الرأس

1. لضبط حجم سماعة الرأس، حرك عصابة الرأس لأعلى ولأسفل حتى تصبح مريحة.
2. حرك ذراع الميكروفون المرن لأعلى أو لأسفل وللداخل أو للخارج حتى يصبح في نفس مستوى القم لالتقاط الصوت بشكل أفضل.
3. يمكن إزالة الذراع بعيداً عند عدم استخدامه.

1

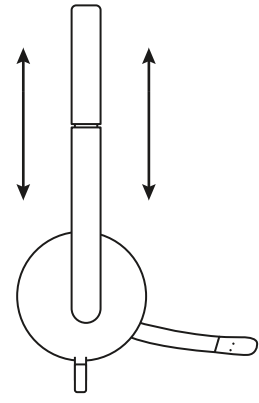

2

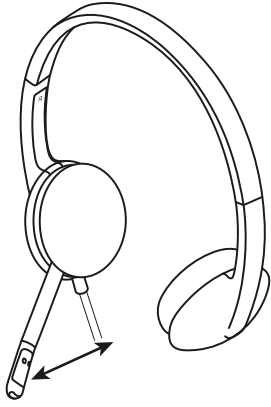

3

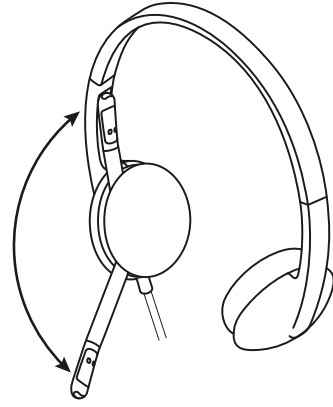

www.logitech.com/support/H340

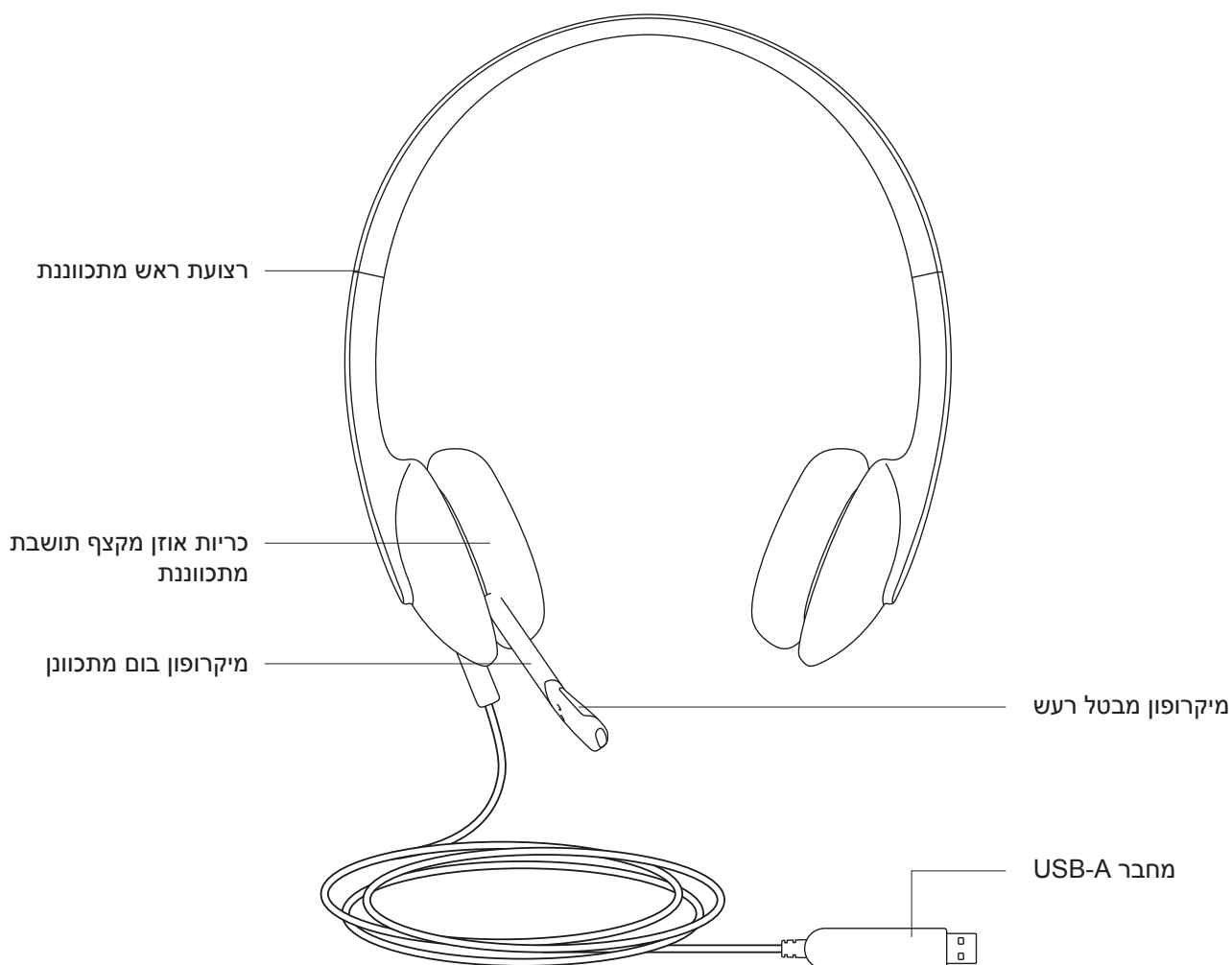

חיבור האוזניות

חבר את מחבר ה-USB-A אל יציאת USB במחשב.

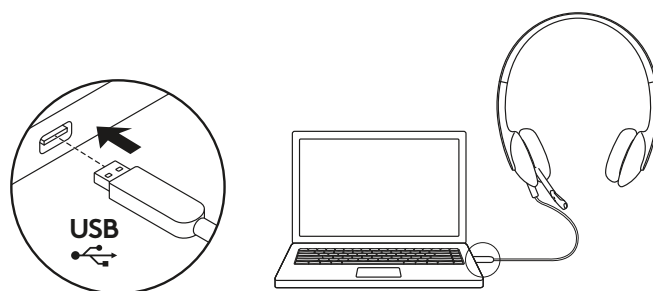

התאמת האוזניות

1. הזז את רצועת הראש כלפי מעלה ומטה על מנת לכוון את גודל האוזניה, עד אשר תותאם בנוחות.
2. הזז את המיקרופון בום כלפי מעלה או מטה עד שיהיה מאוזן מול הפה ללכידת שמע טובה יותר.
3. כאשר לא נעשה שימוש בבום ניתן לקפל אותו.

1

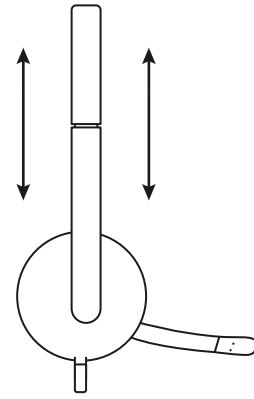

2

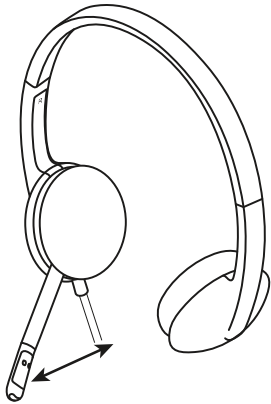

3

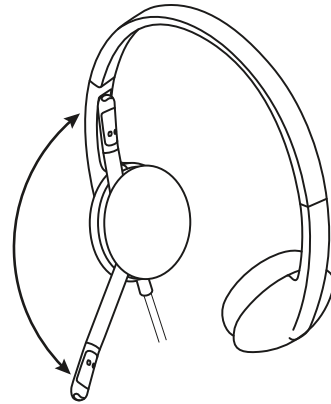

www.logitech.com/support/H340

www.logitech.com/support/H340

© 2019 Logitech. Logitech, Logi and other Logitech marks are owned by Logitech and may be registered. All other trademarks are the property of their respective owners. Logitech assumes no responsibility for any errors that may appear in this manual. Information contained herein is subject to change without notice.

WEB-621-001265.002

logitech®