

Yealink

T56A-Teams[®] Edition

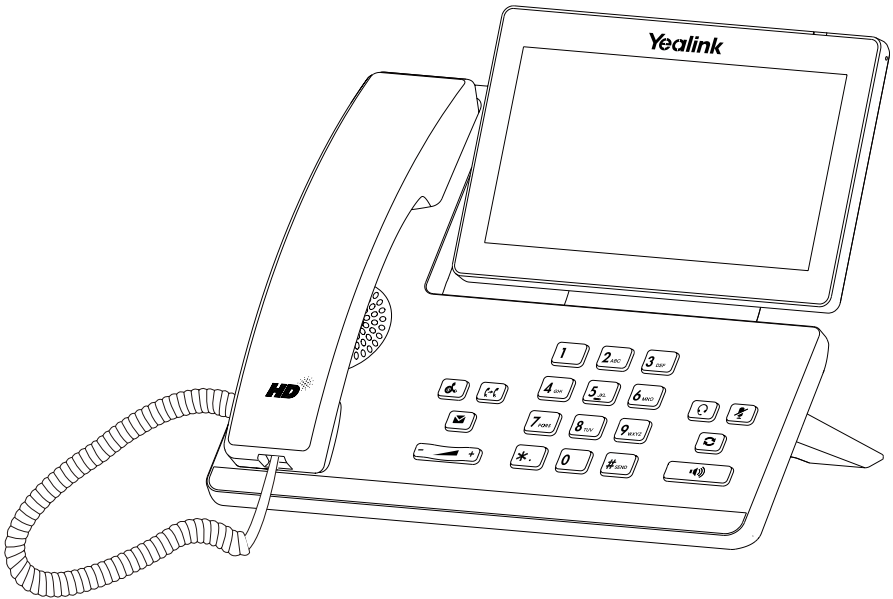

Quick Start Guide(V15.20)

Package Contents

The following items are included in your package. If you find anything missing, contact your system administrator.

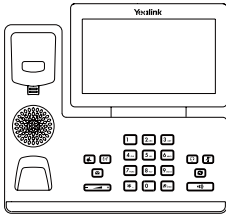

T56A Teams IP Phone



Handset

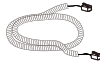

Handset Cord

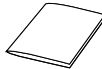

Quick Start Guide



Ethernet Cable
(2m CAT5E FTP cable)

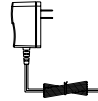

Power Adapter
(Optional)

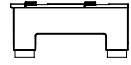

Stand

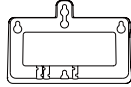

Wallmount Bracket
(Optional)

Note: We recommend that you use the accessories provided or approved by Yealink. The unapproved third-party accessories may result in reduced performance.

Assembling Your Phone

1. Attach the stand and adjust the angle of touch screen:

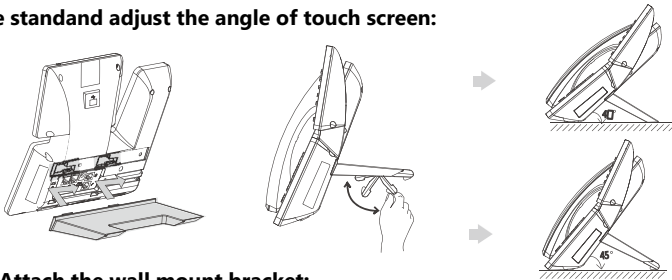

2. Optional: Attach the wall mount bracket:

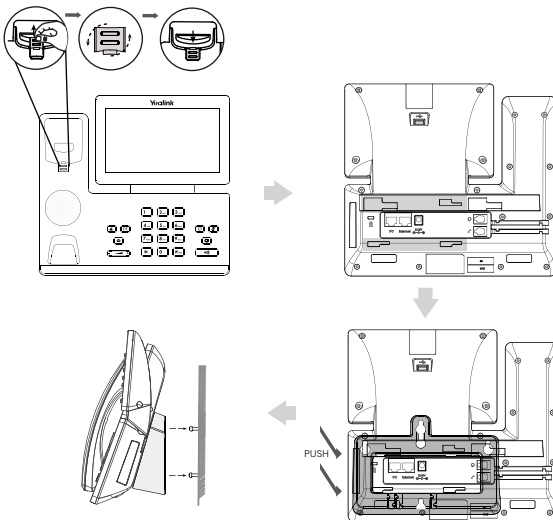

Note: The reversible tab has a lip which allows the handset to stay on-hook when the IP phone is mounted vertically. For more information, refer to Yealink Wall Mount Quick Installation Guide for Yealink IP Phones.

3. Connect the handset and optional headset:

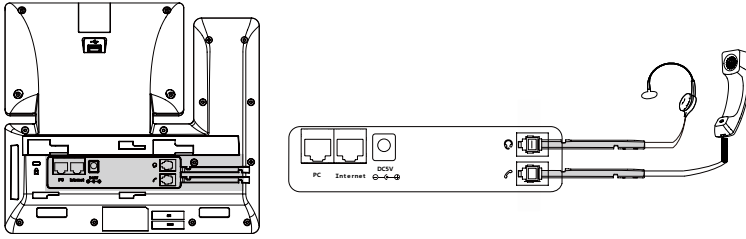

4. Connect the network and power:

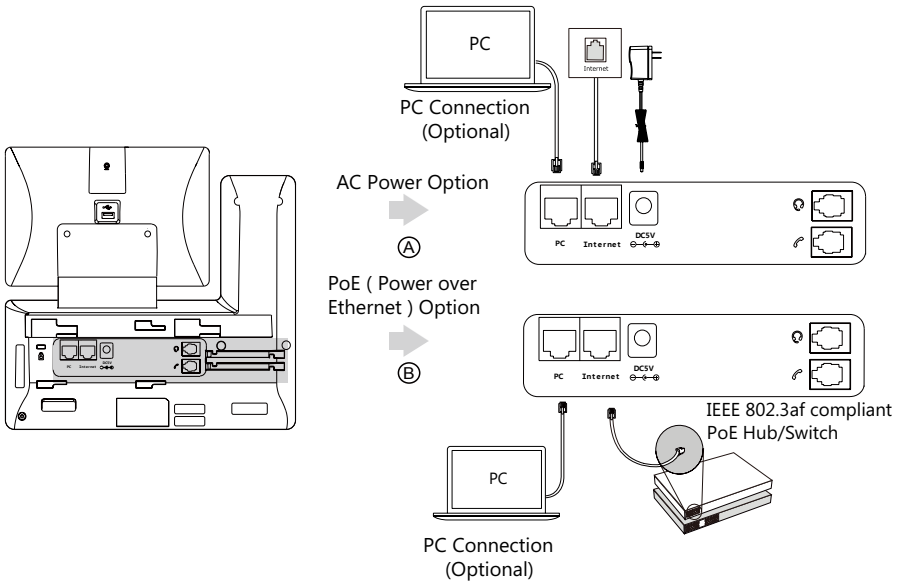

Note: The phone should be worked with Yealink original power adapter (5V/2A) only. The third-party power adapter may damage the phone.
If inline power (PoE) is provided, you don't need to connect the power adapter. Make sure the hub/switch is PoE-compliant.

Hardware Component Instructions

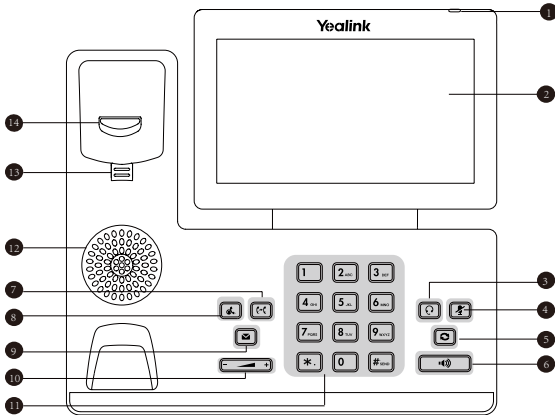

	Item
1	Power LED Indicator
2	Touch Screen
3	HEADSET Key
4	MUTE Key
5	REDIAL Key
6	Speakerphone Key
7	TRANSFER Key
8	HOLD Key
9	MESSAGE Key
10	Volume Key
11	Keypad
12	Speaker
13	Reversible Tab
14	Hookswitch
15	USB2.0 port

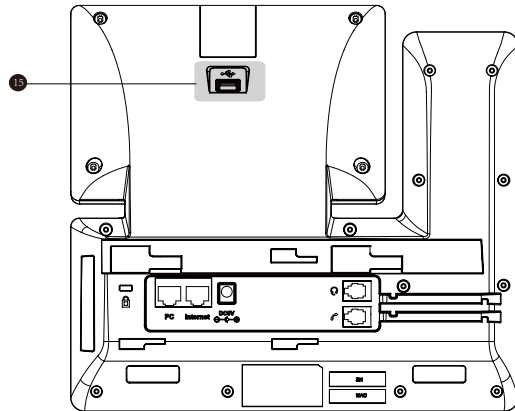

Startup

After the Teams phone is connected to the network and supplied with power, it automatically begins the initialization process. After startup, select a desired language and then the phone enters the sign-in screen.

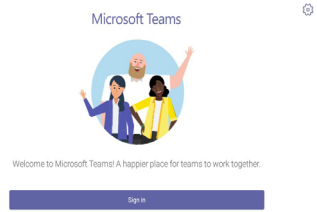

Sign into or Sign out of Your Microsoft Online Account

You can sign into or sign out of your Microsoft online account on the phone.

To sign into your online account:

1. Tap **Sign in**.

You will be connected to the Company Portal automatically.

2. Follow the on-screen prompts.

If you select shared mode, you can only place calls, receive calls and join the scheduled Teams meetings.



To sign out of your online account:

1. Tap  at the top-left corner of the touch screen.
2. Tap **Sign Out**.

Phone Lock

You can enable the phone lock feature to prevent it from unauthorized use.

To enable the phone lock feature:

1. Tap  at the top-left corner of the touch screen.
2. Navigate to **Settings->Device Settings->Phone Lock**.
3. Turn on **Lock Enable**.
4. Enter the lock PIN in the **New PIN** field.
5. Enter the lock PIN again in the **Confirm PIN** field.
6. Select a desired value in the **Idle time-out** field.
7. Tap  to accept the change.

The phone will lock automatically when it has been inactive for a specified time.

To unlock the phone:

1. Tap  when the phone is locked.
2. Enter the unlock PIN.

Change Your Presence Status

Your presence information is a quick way for other people to see your availability status. You can change it manually if you want to.



To change your presence status:



1. Tap  at the top-left corner of the touch screen.

2. Tap the presence status field to select a desired status.



Basic Call Features

To place a call:





1. Tap  on the **Calls** screen.
2. Enter the account information of the contact to search and then select the desired contact.
3. Tap  at the top-left corner of the touch screen.

You can pick up the handset, press  or press  to place a call by using the dialer.

To answer a call:

1. Do one of the following:
 - Pick up the handset. The call is answered in handset mode.
 - Press . The call is answered in hands-free (speakerphone) mode.
 - Press . The call is answered in headset mode.
 - Tap  on the touch screen.



To end a call:

1. Do one of the following:
 - If you are using the handset, hang up the handset or tap .
 - If you are using the speakerphone, press  or tap .
 - If you are using the headset, press  or tap .



To redial a call:

1. Press  when the phone is idle to dial out the last dialed number.

To mute or un-mute a call:

1. Press  or tap  to mute the microphone or press it again to un-mute the microphone during a call.

To place a call on hold:

1. Press  or tap  -> **Place call on hold** during an active call.



To resume the held call:

1. Press  or tap **Resume**.



Initiate a Conference Call

You can initiate a conference call by calling multiple contacts or by inviting other contacts.

To initiate a conference by calling multiple contacts:

1. Tap  on the touch screen.
2. Enter the account information of the participant to search and then select the desired contact.
You can add multiple contacts.
3. Tap  at the top-left corner of the touch screen.

To initiate a conference call by inviting other contacts:

1. During a call, tap .
2. Tap  at the bottom-right corner.
3. Enter the account information of the participant to search and then add members.
4. Tap  to initiate a conference.

Call Forward

You can enable the call forward feature to forward all incoming calls to the desired destination.

To enable call forward:

1. Tap  at the top-left corner of the touch screen.



2. Navigate to **Settings>Calls->Call forwarding**.
3. Turn on **Call forwarding**.
4. Tap the **Forward to** field to select a desired forwarding type.

The incoming calls will be automatically forwarded to the destination you selected.



Call Transfer

You can transfer a call in the following ways:

To perform a blind transfer:



1. Press  or tap ->**Transfer->Transfer now** during an active call.
The call is placed on hold.
2. Enter the account information of the contact to search and then select the desired contact.
The call is connected to the number to which you are transferring.

To perform a consultative transfer:

1. Tap ->**Transfer->Consult first** during an active call.
The call is placed on hold.
2. Enter the contact account information to search and then select the desired contact.
3. After the party answers the call, tap  beside the transferred contact.
It prompts you whether to transfer the call or not.
4. Tap **OK** to complete the transfer.
5. After the party answers the call again, the call is transferred successfully.

Teams Meeting

To schedule a meeting:

1. Tap **Meetings** on the touch screen.
2. Tap .
3. Enter the title, add the participants and select start time and end time.
You can enable **All day** to set up a whole day meeting.
4. Enter the location and select the repetition period.
5. To show others your availability during this time, tap the **Show As** field and then select **Busy**, **Free**, **Tentative** or **Out of office**.
6. Optional: Enter the description of the meeting.
7. Tap  to schedule the meeting.

To join a scheduled meeting:

1. Tap **Meetings** on the touch screen.
2. Tap **Join** beside the meeting.

Regulatory Notices

Operating Ambient Temperatures

- Operating temperature: +32 to 104°F (0 to 40°C)
- Relative humidity: 5% to 90%, noncondensing
- Storage temperature: -22 to +160°F (-30 to +70°C)

Warranty

Our product warranty is limited only to the unit itself, when used normally in accordance with the operating instructions and the system environment. We are not liable for damage or loss resulting from the use of this product, or for any claim from a third party. We are not liable for problems with Yealink device arising from the use of this product; we are not liable for financial damages, lost profits, claims from third parties, etc., arising from the use of this product.

Explanation of the symbols

•DC symbol

is the DC voltage symbol.

•WEEE Warning symbol

To avoid the potential effects on the environment and human health as a result of the presence of hazardous substances in electrical and electronic equipment, end users of electrical and electronic equipment should understand the meaning of the crossed-out wheeled bin symbol. Do not dispose of WEEE as unsorted municipal waste and have to collect such WEEE separately.

•Restriction of Hazardous Substances Directive (RoHS)

This device complies with the requirements of the EU RoHS Directive. Statements of compliance can be obtained by contacting support@yealink.com.

•Safety Instructions

Save these instructions. Read these safety instructions before use!

▲ General Requirements

- Before you install and use the device, read the safety instructions carefully and observe the situation during operation.
- During the process of storage, transportation, and operation, please always keep the device dry and clean, avoid collision and crash.
- Please attempt not to dismantle the device by yourself. In case of any discrepancy, please contact the appointed maintenance center for repair.
- Please refer to the relevant laws and statutes while using the device. Legal rights of others should be respected as well.

▲ Environmental Requirements

- Place the device at a well-ventilated place. Do not expose the device under direct sunlight.
- Keep the device dry and free of dusts.
- Do not place the device on or near any inflammable or fire-vulnerable object, such as rubber-made materials.
- Keep the device away from any heat source or bare fire, such as a candle or an electric heater.

▲ Operating Requirements

- Do not let a child operate the device without guidance.
- Do not let a child play with the device or any accessory in case of accidental swallowing.
- Please use the accessories provided or authorized by the manufacturer only.
- The power supply of the device shall meet the requirements of the input voltage of the device. Please use the provided surge protection power socket only.
- Before plugging or unplugging any cable, make sure that your hands are completely dry.
- Do not spill liquid of any kind on the product or use the equipment near water, for example, near a bathtub, washbowl, kitchen sink, wet basement or near a swimming pool.
- During a thunderstorm, stop using the device and disconnect it from the power supply. Unplug the power plug and the Asymmetric Digital Subscriber Line (ADSL) twisted pair (the radio frequency cable) to avoid lightning strike.
- If the device is left unused for a rather long time, disconnect it from the power supply and unplug the power plug.
- When there is smoke emitted from the device, or some abnormal noise or smell, disconnect the device from the power supply, and unplug the power plug immediately.

About Yealink

Yealink is a global leading provider of enterprise communication and collaboration solutions, offering video conferencing service to worldwide enterprises. Focusing on research and development, Yealink also insists on innovation and creation. With the outstanding technical patents of cloud computing, audio, video and image processing technology, Yealink has built up a panoramic collaboration solution of audio and video conferencing by merging its cloud services with a series of endpoints products. As one of the best providers in more than 140 countries and regions including the US, the UK and Australia, Yealink ranks No.1 in the global market share of SIP phones shipments.

Technical Support

Visit Yealink WIKI (<http://support.yealink.com/>) for the latest firmware, guides, FAQ, Product documents, and more. For better service, we sincerely recommend you to use Yealink Ticketing system (<https://ticket.yealink.com>) to submit all your technical issues.

- Contact the specified maintenance center for repair.
- Do not insert any object into equipment slots that is not part of the product or auxiliary product.
- Before connecting a cable, connect the grounding cable of the device first. Do not disconnect the grounding cable until you disconnect all other cables.

▲ Operating Requirements

- Before cleaning the device, disconnect it from the power supply.
- Use a piece of soft, dry and anti-static cloth to clean the device.
- Keep the power plug clean and dry.

Troubleshooting

The unit cannot supply power to device other than Yealink device.

There is a bad connection with the plug.

1. Clean the plug with a dry cloth.

2. Connect it to another wall outlet.

The usage environment is out of operating temperature range.

1. Use in the operating temperature range.

The cable between the unit and the Yealink device is connected incorrectly.

1. Connect the cable correctly.

You cannot connect the cable properly.

1. You may have connected a wrong Yealink device.

2. Use the correct power supply.

Some dust, etc., may be in the port.

1. Clean the port.

Contact your dealer or authorized service facility for any further questions.

FCC Statement

This device complies with part 15 of the FCC Rules. Operation is subject to the following two conditions: (1) this device may not cause harmful interference, and (2) this device must accept any interference received, including interference that may cause undesired operation. Any Changes or modifications not expressly approved by the party responsible for compliance could void the user's authority to operate the equipment.

IC Statement

This device complies with Industry Canada's licence-exempt RSSs.

Operation is subject to the following two conditions:

(1) this device may not cause interference; and

(2) this device must accept any interference, including interference that may cause undesired operation of the device. CAN ICES-3(B)

Le présent appareil est conforme aux CNR d'Industrie Canada applicables aux appareils radio exempts de licence. L'exploitation est autorisée aux deux conditions suivantes :

(1) l'appareil ne doit pas produire de brouillage;

(2) l'utilisateur de l'appareil doit accepter tout brouillage radioélectrique subi, même si le brouillage est susceptible d'en compromettre le fonctionnement. NMB-3(B)

Radiation Exposure Statement

This equipment complies with FCC and IC radiation exposure limits set forth for an uncontrolled environment. This equipment should be installed and operated with minimum distance 20cm between the radiator and your body.

Cet émetteur ne doit pas être Co-placé ou ne fonctionnant en même temps qu'aucune autre antenne ou émetteur. Cet équipement devrait être installé et actionné avec une distance minimum de 20 centimètres entre le radiateur et votre corps.

Contact Information

YEALINK NETWORK TECHNOLOGY CO.,LTD.

309, 3rd Floor, No.16, Yun Ding North Road, Huli District, Xiamen City,

Fujian, P.R. China

YEALINK (EUROPE) NETWORK TECHNOLOGY B.V.

Strawinskylaan 3127, Atrium Building, 8th floor, 1077ZX Amsterdam, The Netherlands

YEALINK (USA) NETWORK TECHNOLOGY CO., LTD.

999 Peachtree Street Suite 2300, Fulton, Atlanta, GA, 30309, USA

Made in China

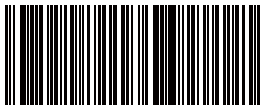

T5 6A-T ea ms-E N

YEALINK(XIAMEN) NETWORK TECHNOLOGY CO.,LTD.

Web: www.yealink.com

Copyright©2018YEALINK(XIAMEN) NETWORK TECHNOLOGY CO.,LTD.All rights reserved.

