

Panasonic

Quick Reference Guide

IP Proprietary Telephone
Model No. **KX-NT630/KX-NT680**

Thank you for purchasing an IP Proprietary Telephone (IP-PT). Please read this manual carefully before using this product and save this manual for future use. For more details as well as settings information, please refer to the manuals of the PBX.

Manuals and supporting information are provided on the Panasonic web site at:
<https://panasonic.net/cns/pcc/support/pbx/>

Note

- In this manual, the suffix of each model number (e.g., KX-NT630**NE**) is omitted unless necessary.
- The illustrations may differ from the appearance of the actual product.

Open Source Software Notice

Parts of this product use open source software. For details about the open source software, refer to the following web site:

<https://panasonic.net/cns/pcc/support/pbx/>

Font Information

Font information is available on the following Panasonic web site:

<https://panasonic.net/cns/pcc/support/pbx/>

Trademarks

- The Bluetooth® word mark and logos are owned by the Bluetooth SIG, Inc. and any use of such marks by Panasonic Corporation is under license.
- All other trademarks identified herein are the property of their respective owners.

For Users in European Countries

The following declaration is applicable to KX-NT680NE / KX-NT680UK / KX-NT680X only.

Hereby, Panasonic Corporation declares that the radio equipment described in this manual is in compliance with Directive 2014/53/EU. The full text of the EU declaration of conformity is available at the following internet address:

<http://www.ptc.panasonic.eu/doc>

Contact to Authorized Representative:

Panasonic Testing Centre

Panasonic Marketing Europe GmbH

Winsbergring 15, 22525 Hamburg, Germany

Ecodesign information

Ecodesign information under EU Regulation (EC) No.1275/2008 amended by (EU) Regulation No.801/2013.

=====
Please visit here: <http://www.ptc.panasonic.eu>
click [Downloads]

→ Energy related products information (Public)

=====
Power consumption in networked standby and guidance are mentioned in the web site above.

For Users in the United Kingdom

- This unit is designed to be installed under controlled conditions of ambient temperature and a relative humidity.
- Avoid installing the unit in damp or humid environments, such as bathrooms or swimming pools.
- 999 and 112 can be dialed on the product after accessing the outside line for the purpose of making outgoing calls to the BT emergency (999) and (112) services. The method for accessing an outside line

differs depending on the SIP server. For details, confirm the features of the SIP server.

For Users in Australia

WARNING

- Please ensure that a separate telephone, not dependent on local power, is available for emergency use.
- This equipment will be inoperable when mains power fails.
- No "000" or other calls can be made from this device during a mains power failure.

For Users in Australia and the United Kingdom

- This unit is capable of being used in conjunction with hearing aids fitted with inductive coil pick-ups. The handset should be held as for normal conversation. For operation, the hearing aid should be set to its "T" position or as directed in the operating instructions for the hearing aid.
- This unit is designed to aid the visually handicapped to locate dial keys and buttons.



For Users in New Zealand

- This equipment shall not be set to make automatic calls to the Telecom '111' Emergency Service.

PTC General Warning

- The grant of a Telepermit for any item of terminal equipment indicates only that Telecom has accepted that the item complies with minimum conditions for connection to its network. It indicates no endorsement of the product by Telecom, nor does it provide any sort of warranty.

Important Information

Above all, it provides no assurance that any item will work correctly in all respects with another item of Telepermitted equipment of a different make or model, nor does it imply that any product is compatible with all of Telecom's network services.

The Use of IP Networks through the PSTN

- Internet Protocol (IP) by its nature introduces delay into speech signals as each data packet is formulated and addressed. Telecom Access Standards recommends that suppliers, designers and installers using this technology for calls to or from the PSTN refer to ITU E Model requirements in the design of their networks. The overall aim is to minimize delay, distortion and other transmission impairments, particularly for those calls involving cellular and international networks, which already suffer extensive delay.

Echo cancellation

- Echo cancelers are not normally required in the Telecom PSTN because geographic delays are acceptable where CPE return loss is maintained within Telepermit limits. However, those private networks making use of Voice over IP technology are required to provide echo cancellation for all voice calls. The combined effect of audio/VoIP conversion delay and IP routing delay can cause the echo cancellation time of ≥ 64 ms to be required.

Important Notice

- Under power failure conditions this appliance may not operate. Please ensure that a separate telephone, not dependent on local power, is available for emergency use.
- No "111" or other calls can be made from this device during a mains power failure.

For Users in the United States

FCC Note

- This equipment has been tested and found to comply with the limits for a Class B digital device, pursuant to Part 15 of the FCC Rules. These limits are designed to provide reasonable protection against

harmful interference in a residential installation. This equipment generates, uses, and can radiate radio frequency energy and, if not installed and used in accordance with the instructions, may cause harmful interference to radio communications. However, there is no guarantee that interference will not occur in a particular installation. If this equipment does cause harmful interference to radio or television reception, which can be determined by turning the equipment off and on, the user is encouraged to try to correct the interference by one or more of the following measures:

- Reorient or relocate the receiving antenna.
- Increase the separation between the equipment and receiver.
- Connect the equipment to an outlet on a circuit different from that to which the receiver is connected.
- Consult the dealer or an experienced radio/TV technician for help.

FCC CAUTION

Any changes or modifications not expressly approved by the party responsible for compliance could void the user's authority to operate this product.

FCC RF Exposure Warning (KX-NT680 only):

- This product complies with FCC radiation exposure limits set forth for an uncontrolled environment.
- To comply with FCC RF exposure requirements, this product must be installed and operated 20 cm (8 inches) or more between the product and all person's body.
- This product may not be collocated or operated in conjunction with any other antenna or transmitter.

Supplier's Declaration of Conformity

Trade Name:	Panasonic
Model No.:	KX-NT630, KX-NT680
Responsible Party:	Panasonic Corporation of North America Two Riverfront Plaza, Newark, NJ 07102-5490
Support Contact:	1 (800) 528-6747 Option 1

Important Information

This device complies with Part 15 of the FCC Rules. Operation is subject to the following two conditions:

(1) this device may not cause harmful interference, and (2) this device must accept any interference received, including interference that may cause undesired operation.

FCC ID can be found on the bottom of the units. (KX-NT680 only)
Privacy of communications may not be ensured when using this phone.

Hearing Aid Compatibility

This telephone provides magnetic coupling for hearing aids as defined by the FCC in 47 CFR Section 68.316. Use only handsets or other acoustic devices with this equipment that are compliant with the hearing aid compatibility requirements of FCC Part 68.

When you hold the phone to your ear, noise might be heard in your Hearing Aid. Some Hearing Aids are not adequately shielded from external RF (radio frequency) energy. If noise occurs, use an optional headset accessory or the speakerphone option (if applicable) when using this phone. Consult your audiologist or Hearing Aid manufacturer about the availability of Hearing Aids which provide adequate shielding to RF energy commonly emitted by digital devices.

Compliance with TIA-1083 standard:



Telephone handsets identified with this logo have reduced noise and interference when used with T-Coil equipped hearing aids and cochlear implants.

WHEN PROGRAMMING EMERGENCY NUMBERS AND/OR MAKING TEST CALLS TO EMERGENCY NUMBERS:

1. Remain on the line and briefly explain to the dispatcher the reason for the call before hanging up.
2. Perform such activities during off-peak hours, such as early morning or late evening.

For Users in Canada

Industry Canada Notices and Other Information

This product meets the applicable Innovation, Science and Economic Development Canada technical specifications.

Notice

- This device complies with Industry Canada licence-exempt RSS standard(s). Operation is subject to the following two conditions: (1) this device may not cause interference, and (2) this device must accept any interference, including interference that may cause undesired operation of the device.
- This Class B digital apparatus complies with Canadian ICES-003.

CAUTION

Any changes or modifications not expressly approved by the party responsible for compliance could void the user's authority to operate this product.

Compliance with TIA-1083 standard:



Telephone handsets identified with this logo have reduced noise and interference when used with T-Coil equipped hearing aids and cochlear implants.

Important Information

RF Exposure Warning:

- This product complies with IC radiation exposure limits set forth for an uncontrolled environment.
- To comply with IC RF exposure requirements, this product must be installed and operated 20 cm (8 inches) or more between the product and all person's body.
- This product may not be collocated or operated in conjunction with any other antenna or transmitter.

Privacy of communications may not be ensured when using this phone.

Bluetooth Specification (KX-NT680 only)

Frequency Band: 2.402 GHz to 2.480 GHz Maximum Power Output: 2.5 mW

Accessory Information

Included Accessories

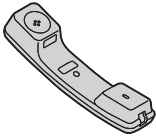
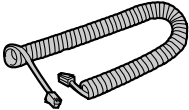
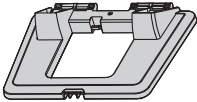
Handset (1)	Handset Cord (1)	Stand (1)
		

Note

- The illustrations may differ from the appearance of the actual product.

Optional Accessories



Model	AC adaptor*1	Wall Mount Kit*2
KX-NT630NE/ KX-NT680NE	KX-A424CE (PNLV6508)	KX-A435X
KX-NT630/ KX-NT680	KX-A424 (PNLV6508)	KX-A435
KX-NT630C/ KX-NT680C	KX-A424 (PNLV6508)	KX-A435
KX-NT630X/ KX-NT680X	KX-A424CE (PNLV6508)/ KX-A424E (PNLV6508)/ KX-A424AG (PNLV6508)/ KX-A424BR (PNLV6508)/ KX-A424X (PNLV6508)/ KX-A424AL (PNLV6508)/ KX-A424TW (PNLV6508)	KX-A435X
KX-NT630UK/ KX-NT680UK	KX-A424CE (PNLV6508)/ KX-A424E (PNLV6508)	KX-A435X
KX-NT680MS	KX-A424E (PNLV6508)	KX-A435X
KX-NT680SX	KX-A424SX (PNLV6508)	—

Accessory Information

*1 This unit complies with the IEEE 802.3af Power-over-Ethernet (PoE) standard. If PoE is available on your network, this unit can receive the necessary power from the network through the Ethernet cable. In this case, no AC adaptor is needed.

To order an optional AC adaptor, please order using the "KX-A424xx" model number. For details about which AC adaptor model number you should order, consult your dealer.

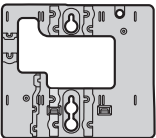
*2 The Wall Mount Kit contains the following accessories.

Wall mounting adaptor (1)	Screws for wall mounting (3)*
	

* Two screws are for attaching the unit to a wall. One screw is for attaching the wall mounting adaptor to the unit.

Location of Controls

KX-NT630NE

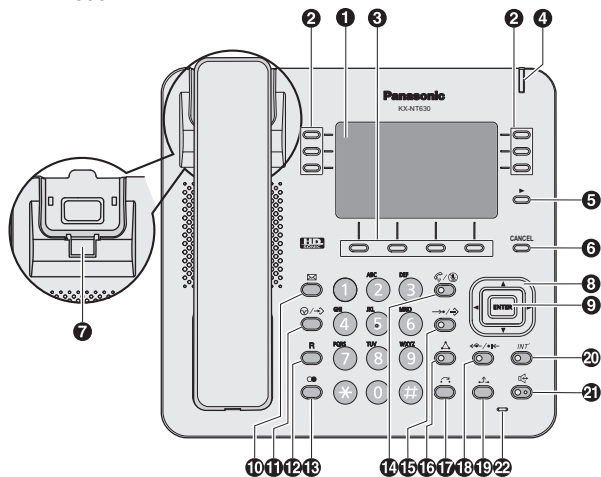

Location of Controls

KX-NT630X/KX-NT630UK

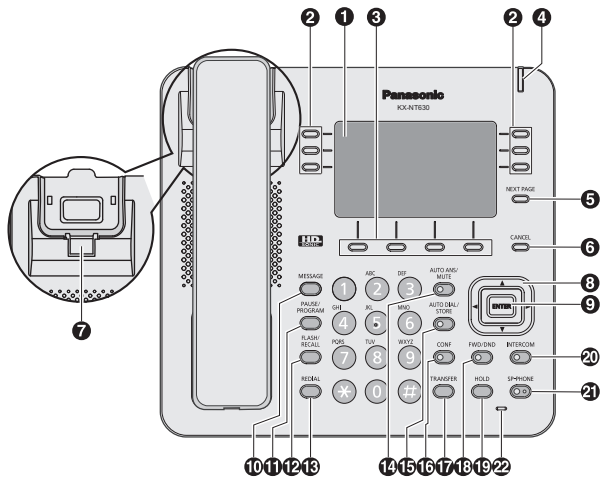

KX-NT630

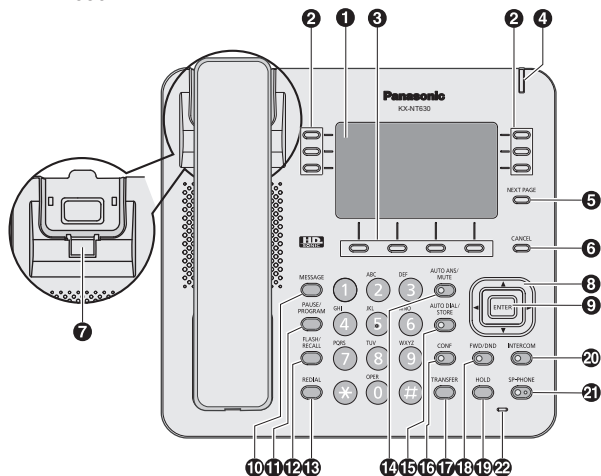

Location of Controls

KX-NT630C

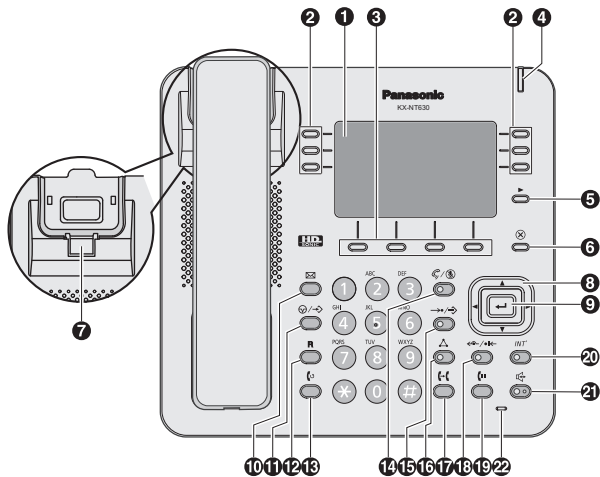

KX-NT680NE

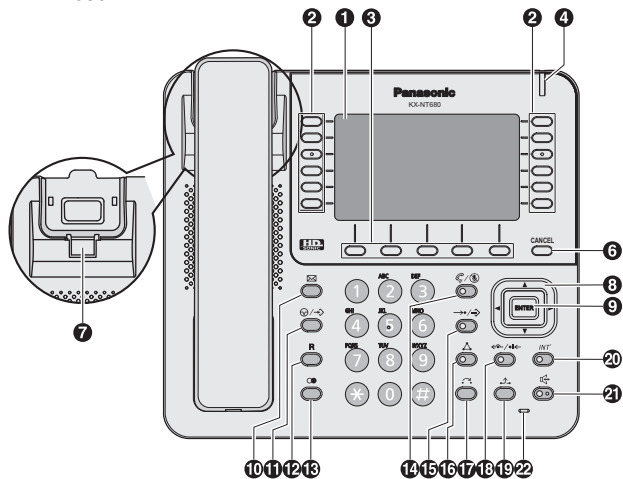

Location of Controls

KX-NT680X/KX-NT680UK/KX-NT680SX/KX-NT680MS

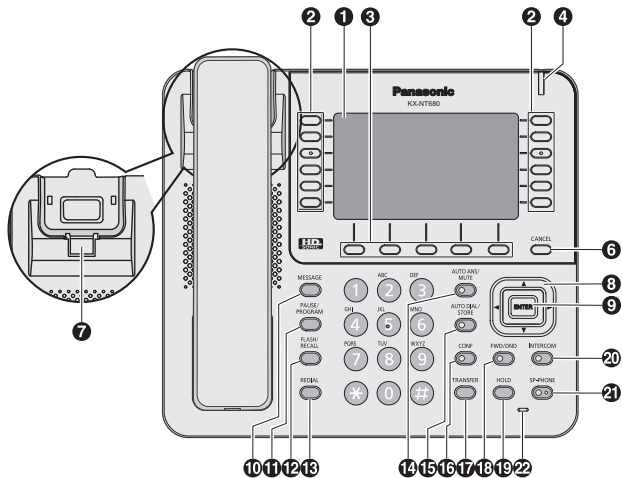



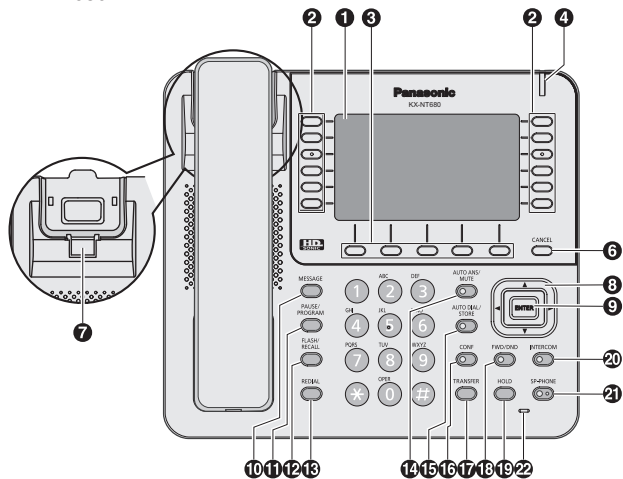



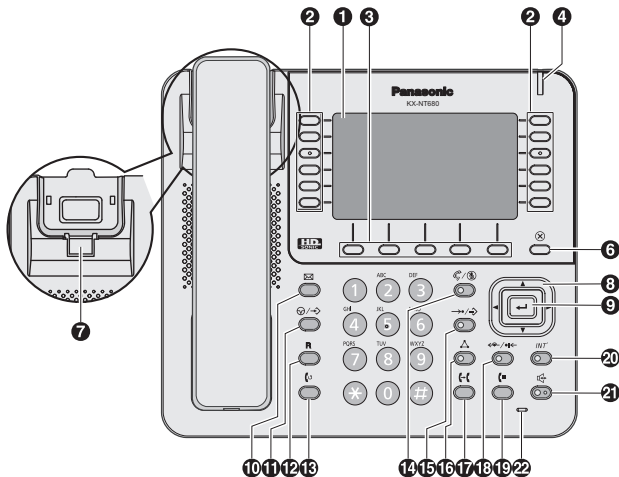









KX-NT680



KX-NT680C



- 1 LCD (Liquid Crystal Display):**
KX-NT630: 3.6 inch monochrome, 6 lines
KX-NT680: 4.3 inch color
- 2 Flexible Buttons:** Used to seize an outside line or perform a feature that has been assigned to the button.
- 3 Soft Buttons (KX-NT630: S1–S4, KX-NT680: S1–S5):**
Soft buttons (located from left to right) are used to select the item displayed on the bottom line of the display.
- 4 Message/Ringer Lamp:** When you receive an intercom call, the lamp flashes green, and on an outside call, the lamp flashes red. When someone has left you a message, the lamp stays on red.
- 5 [▶] / [NEXT PAGE]:** Used to switch the page for the flexible buttons. (KX-NT630 only)
- 6 [⊗] / [CANCEL]:** Used to cancel the selected item.

- 7 **Handset Hook:** Keeps the handset stable when the unit is mounted on a wall.
- 8 **Navigator Key:** Used to adjust the volume and so on.
- 9 [] / **[ENTER]:** Used to assign the selected item.
- 10 [] / **[MESSAGE]:** Used to leave a message waiting indication or call back the party who left the message waiting indication.
- 11 [] / **[PAUSE/PROGRAM]:** Used to insert a pause when storing a telephone number. This button is also used for programming this unit.
- 12 [**R**] / **[FLASH/RECALL]:** Used to disconnect the current call and make another call without hanging up.
- 13 [] / [] / **[REDIAL]:** Used to redial the last dialed number.
- 14 [] / [] / **[AUTO ANS/MUTE]:** Used to receive an incoming call in hands-free mode or mute the microphone/handset during a conversation.
- 15 [] / [] / **[AUTO DIAL/STORE]:** Used for System/Personal Speed Dialing or storing program changes.
- 16 [] / **[CONF]:** Used to establish a multiple party conversation.
- 17 [] / [] / **[TRANSFER]:** Used to transfer a call to another party.
- 18 [] / [] / **[FWD/DND]:** Used to switch Call Forwarding or Do Not Disturb on your extension.
- 19 [] / [] / **[HOLD]:** Used to place a call on hold.
- 20 [**INT'**] / **[INTERCOM]:** Used to make or receive intercom calls.
- 21 [] / **[SP-PHONE (Speakerphone)]:** Used for performing hands-free operations.
- 22 **Microphone:** Used for hands free conversations.

Before Operating the Telephone

Speaker volume

While in a hands-free conversation
Press [▲] or [▼] to adjust the volume.

Handset/Headset volume*1

While using the handset or headset
Press [▲] or [▼] to adjust the volume.

Ringer volume

While receiving a call
Press [▲] or [▼] to adjust the volume.
While on-hook
Press [▲] to confirm current volume and Press [▲] or [▼] to adjust the volume.

LCD contrast*2

While on-hook

1. Press [⊕/→] / [PAUSE/PROGRAM].
2. Enter 0①.
3. Press [←] / [ENTER].
4. Press [▲] or [▼] to adjust the LCD contrast (KX-NT630) or the LCD backlight (KX-NT680).
5. Press [←] / [ENTER].
6. Press [⊗] / [CANCEL].

Ring tone

1. Press [⊕/→] / [PAUSE/PROGRAM].
2. Press a flexible button or [INT'] / [INTERCOM] 2 times.
3. Enter 2 digits (01-30) using the dial keys (0-9), or press [▲] or [▼] to select the ring tone.
4. Press [←] / [ENTER].
5. Press [⊗] / [CANCEL].

*1 If you hear your own voice through the handset or headset, decrease the volume.

*2 Note for KX-NT680

- This setting adjusts the brightness of the LCD backlight instead of the LCD contrast.
- The LCD backlight has a finite lifetime.
- The LCD backlight turns off for a moment every 4 hours, and then it turns on again.

LCD backlight mode (KX-NT630 only)

While on-hook







1. Press [] / [PAUSE/PROGRAM].
2. Enter .
3. Press [] / [ENTER].
4. Press a dial key to select the LCD backlight mode.
: Automatic
: Always ON
: Always OFF
5. Press [] / [ENTER].
6. Press [] / [CANCEL].

Registering the Bluetooth® headset (KX-NT680 only)

1. Set the Bluetooth headset to pairing mode by following the instructions provided with the headset.
2. Press [] / [PAUSE/PROGRAM].
3. Enter .
4. Press [] / [ENTER].
5. Enter the Pass Key and press [] / [ENTER].*1
6. Press [] / [CANCEL].

Before Operating the Telephone

Confirming the ID of the Bluetooth headset and deregistering the Bluetooth headset (KX-NT680 only)

1. Press [ / - 2. Enter  .
- 3. Press [- 4. Press [- 5. Press [

- *1 For more information regarding the Pass Key of your headset, refer to the operating instructions of your headset.
- *2 Confirm that the displayed ID is the ID of your headset. For more information regarding the ID of your headset, refer to the operating instructions of your headset.
- *3 If you do not wish to perform deregistration, press [

Feature Operations

Making Calls

Calling

[To an extension]

1. Go off-hook.
2. Dial an extension number.

[To an outside party]

1. Go off-hook.
2. Press a flexible button.
3. Dial the outside party's phone number.

Redial

1. Go off-hook.
2. Press [●] / [☺] / [REDIAL].

Quick Dialing

1. Go off-hook.
2. Dial a quick dialing number.

Doorphone Call

1. Go off-hook.
2. Enter *31.
3. Enter a doorphone number (2 digits).
4. After the confirmation tone, talk.

System Speed Dialing

1. Go off-hook.
2. Press [→•↻] / [AUTO DIAL/STORE].
3. Enter a system speed dialing number (3 digits).

Feature Operations

Personal Speed Dialing

[To store]

1. Go off-hook.
2. Enter ***30**.
3. Enter a personal speed dialing number (2 digits).
4. Enter the phone number to store (max. 32 digits).^{*1}
5. Press **#**.
6. After the confirmation tone, go on-hook.

[To dial]

1. Go off-hook.
2. Press **[→•/•→]** / [AUTO DIAL/STORE].
3. Enter *****.
4. Enter a personal speed dialing number (2 digits).

One-touch Dialing

[To store]

1. Press **[☺/→]** / [PAUSE/PROGRAM].
2. Press a flexible button.
3. Enter **2**.
4. Enter the number to store (max. 32 digits).^{*1}
5. Press **[←]** / [ENTER].
6. Enter the text to store (max. 12 digits).
7. Press **[←]** / [ENTER].
8. Press **[⊗]** / [CANCEL].

[To dial]

1. Go off-hook.
2. Press the flexible button assigned as a One-touch Dialing button.

^{*1} Enter the outside line access number before an outside phone number.

During a Conversation

Call Hold

[To hold]

1. Press [**⏸**] / [**⏸**] / [HOLD].
2. After the confirmation tone, go on-hook.

[To retrieve a call at the holding extension]

1. Go off-hook.
2. Press a flexible button or [**INT'**] / [INTERCOM].

[To retrieve an outside call from another extension]

1. Go off-hook.
2. Press a flexible button.

Call Transfer

[To an extension]

1. Press [**↶**] / [**↶**] / [TRANSFER].
2. After the confirmation tone, dial an extension number.
3. Talk.
4. Go on-hook.

[To an outside party]

1. Press [**↶**] / [**↶**] / [TRANSFER].
2. After the confirmation tone, press a flexible button.
3. Dial an outside phone number.
4. Talk.
5. Go on-hook.

Multiple Party Conversation

[To add other parties during a conversation]

1. Press [**△**] / [CONF].
2. After the confirmation tone, dial the phone number of the party to add.
3. Talk to the new party.
4. Press [**△**] / [CONF].
5. After the confirmation tone, talk with multiple parties.

[To leave a conference]

1. Press [**△**] / [CONF].
2. After the confirmation tone, go on-hook.

Self Labeling

The KX-NT630 features 6 flexible buttons, and the KX-NT680 features 12 flexible buttons. Each item can be named on the LCD screen through personal or system programming to reflect the function of its corresponding flexible button. Additionally, the flexible buttons can be organized into 4 “pages”, allowing you to assign a total of 24 items (KX-NT630)/48 items (KX-NT680).

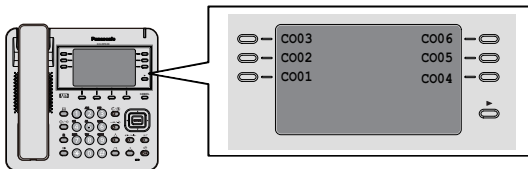

Storing a One-touch Dialing button, and setting the displayed text for the Self Labeling LCD Display

1. Press [\odot / \rightarrow] / [PAUSE/PROGRAM].
2. Press a flexible button, or press the \blacktriangleright / [NEXT PAGE] button (KX-NT630)/Soft button: S5 (KX-NT680), and then press a flexible button.
3. Enter ②.
4. Enter the number to store (max. 32 digits).^{*1}
5. Press [\leftarrow] / [ENTER].
6. Enter the text to store (max. 12 digits).
7. Press [\leftarrow] / [ENTER].
8. Press [\otimes] / [CANCEL].

^{*1} Enter the outside line access number before an outside phone number.

Installation and Setup

Note

- Panasonic assumes no responsibility for injuries or property damage resulting from failures arising out of improper installation or operation inconsistent with this documentation.

Attaching the Stand

Note

- If you place the display face down when you attach the stand, be sure to place a soft cloth under the display. Failure to do so may result in damage to the display.

- 1 Insert the stand into the slots located in the unit.
- 2 Gently rotate the stand in the direction indicated until it is fixed.

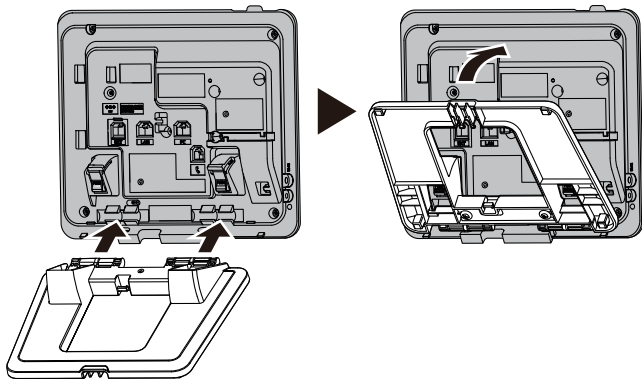

Removing the Stand

Tilt the stand in the direction indicated while pushing the PUSH marks with both hands.

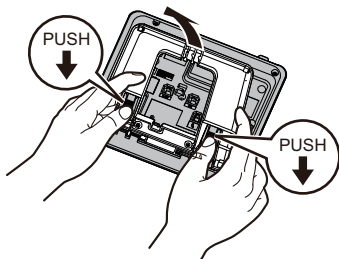

Adjusting the Stand Position

Push the PUSH marks in the direction indicated, with both hands, and tilt and slide the stand until it becomes fixed in the desired position.

Lowering the stand

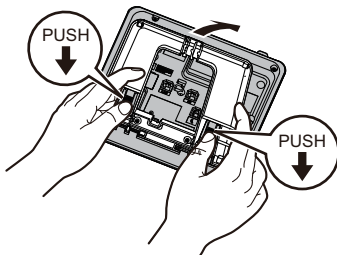

Raising the stand

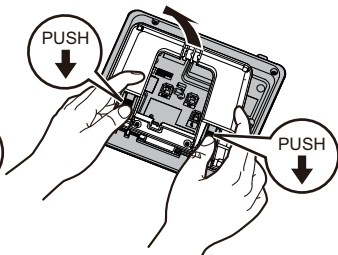

Connections

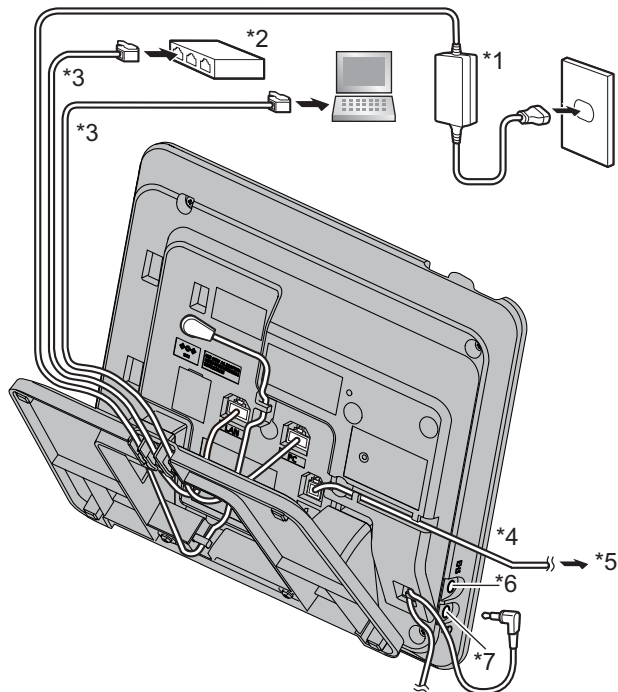

- *1 Optional AC adaptor
- *2 PoE HUB (when not using an AC adaptor) / HUB (when using an AC adaptor)
- *3 Ethernet cable (not included)
- *4 Handset cord (included)
- *5 To a handset
- *6 EHS headset jack (KX-NT680 only)
- *7 Headset jack

Installation and Setup

CAUTION

Optional AC Adaptor

- Use a Panasonic AC adaptor (page 9).
- The AC adaptor is used as the main disconnect device. Ensure that the AC outlet is installed near the unit and is easily accessible.

When connecting a headset

- Ensure that the headset cord has slack and is not pulled tight during use to prevent damage to the connectors.
- Cords used to connect devices to the EHS jack or headset jack must be less than 3 m (9.8 ft) in length.

Note

- For up-to-date information about headsets that have been tested with this unit, refer to the following web site:
<https://panasonic.net/cns/pcc/support/pbx/>

When selecting Ethernet cables (not included)

- Use flexible cables without jack covers. Do not use cables with a hard coating that may tear or crack when bent.
To prevent damage to the cables, use cables that do not protrude from the bottom of the base.
Connect the cables as shown in the following illustration.

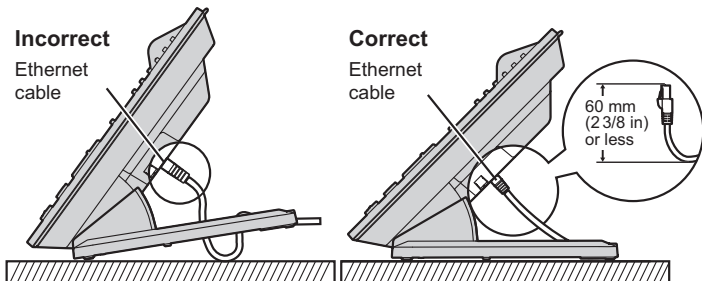

- Use a straight CAT 5e (or higher) Ethernet cable (not included) that is 6.5 mm (1/4 in) in diameter or less.

When connecting to a switching hub

- If PoE is available, an AC adaptor is not needed.

- KX-NT630/KX-NT680 complies with the PoE Class 3 standard.

When connecting a PC

- The PC port does not support PoE for connected devices.

When connecting cables and the AC adaptor

- Pass the Ethernet cable and the AC adaptor cord under the stand.

Wall Mounting

- 1 Connect the handset cord.
- 2 Insert the 3 tabs of the wall mounting adaptor into the designated openings in the base.

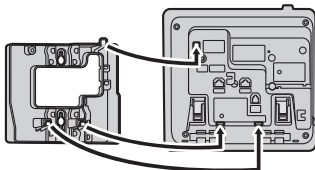

- 3 Fasten the wall mounting adaptor to the base with 1 screw.
(Recommended torque: 0.4 N·m [4.08 kgf·cm/3.54 lbf·in] to 0.6 N·m [6.12 kgf·cm/5.31 lbf·in])
- 4 Connect the cables to the unit, and run the cables through the grooves in the wall mounting adaptor, as shown in the illustration below. Cables marked with "a" may also be run through the corresponding lower grooves.
- 5 Drive the 2 screws into the wall either 83 mm (3 1/4 in) or 100 mm (3 15/16 in) apart, and mount the unit on the wall.

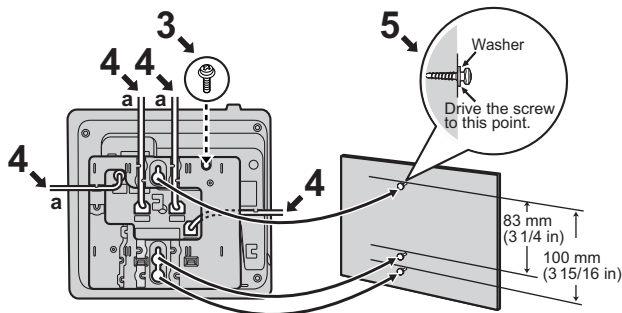

Hooking the Handset

To Hook the Handset during a Conversation

- 1 Hook the handset over the top edge of the unit.

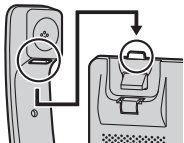

To Lock the Handset Hook when the Unit is Wall Mounted

- 1 Remove the handset hook from the slot.
- 2 Turn it up-side-down.
- 3 Slide the handset hook back into the slot until it locks.
 - Handset is safely hooked when it is in the cradle.

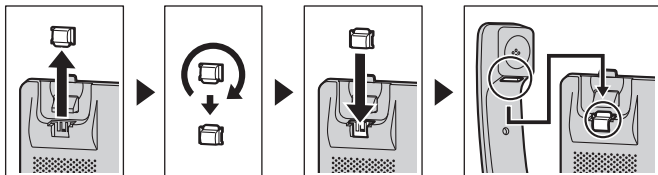

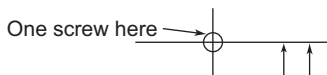

WALL MOUNTING TEMPLATE

1. Drive the screws into the wall as indicated.
2. Hook the unit onto the screw heads.

Note

Make sure to set the print size to correspond with the size of this page. If the dimensions of the paper output still deviate slightly from the measurements indicated here, use the measurements indicated here.

100 mm (3 ¹⁵/₁₆ in)
83 mm (3 ¹/₄ in)

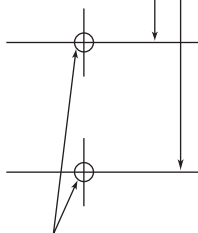

One screw at either point

