

WIRELESS HEADSET EHS GUIDE



Wireless Headset EHS User Guide

Introduction

Electronic Hook Switch(EHS) provides a solution that enables remote operation of answer/end functions for wireless headsets with various phones, thus eliminating the need for a mechanical handset lifter.

Mobility

With an EHS solution you can roam within your premises and still do business on the spot. Wireless headsets with EHS functionality boost productivity as they provide the user with the ability to answer and end a call, while away from their desk.

EHS support the following phone system manufacturers:

Wireless Headset EHS Compatibility Table

Phone Model	EHS Adapter	JPL Part No
AASTRA / MITEL 6771, 6773ip, 6775ip, 7434ip, 7444ip, 5370, 5370ip, 5380, 5380ip *6735i, *6737i, *6753i, *6755i, *6757i	DS-DHSG Cable *Needs Aastra EHS kit	EHS-3
ALCATEL 4028 EE, 4038 EE, 4068 EE	MSH Adapter	EHS-7
AVAYA 1408, 1416, 1608, 1616, 1608i, 1616i, 2410, 4630, 5410, 6224D+M, 6416D+M, 9404, 9406, 9408, 9504, 9508, 9608, 9610, 9611, 9620, 9621, 9630 9640, 9641, 9650, 9670,	AEI-II(Avaya) Adapter Kit	EHS-4
CISCO 7942G , 7945G, 7962G, 7965G, 7975G	HHC Adapter	EHS-2
CISCO (with USB Port) 8961, 9951, 9971	HHC-2 Adapter	EHS-12
ERICSSON-LG LIP-9010, LIP-9020, LIP-9030, LIP-9040	LG EHS Adapter Needs Ericsson-LG EHSA Kit	EHS-11
PANASONIC HDV230, HDV330, HDV430, NT543 , NT553, NT556, DT543, DT546	Panasonic compatible EHS Cable	EHS-1
POLYCOM IP 320, 321, 330, 331, 335, 430, 450, 550, 650, 670, VVX 300, 310, 400, 410, 500, 600, 1500	Polycom compatible EHS Cable	EHS-5
SHORETEL IP 565g, 560g, 560, 265, 230, 230g	AEI-II Adapter Kit	EHS-8
SIEMENS/UNIFY OpenStage 40/60/80 OptiPoint Basic/Std/Adv/Eco	DS-DHSG Cable	EHS-3
SNOM *300, *320, *360, *370, *720, *760, *820, *821, *870	DS-Gender *Needs SNOM EHS Adapter	EHS-6
TOSHIBA DP5022-SD, DP5022-SDM, DP5032-SD, DP5122-SD, DP5130-FSDL, DP5130-SDL, DP5132-SD, IP5022-SD, IP5122-SD, IP5122-SDC, IP5131-SDL, IP5132-SD	SHR (Toshiba)Adapter Kit	EHS-8
YEALINK *T26P, *T27G, *T27P, *T28P, *T29G, *T40G, *T40P, *T41S, *T41P, *T42S, *T42G, *T46S, *T46G,* T48S	DS-Gender *Needs Yealink EHS Adapter	EHS-6
SMART PHONE Galaxy & iPhone Series	SmartPhone EHS Adapter	EHS-9

Aastra/Mitel EHS setup guide

Aastra/Mitel	Phones
	6771/6773ip/6775ip 7434ip/7444ip 5370,5370ip 5380/5380ip



EHS-3

① Connection Diagram

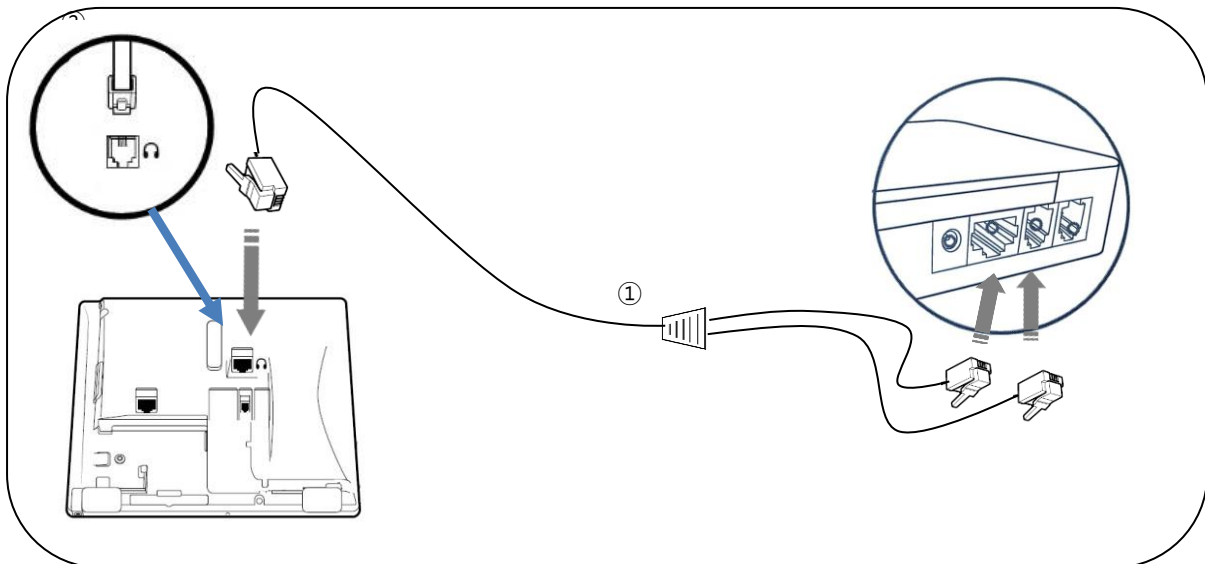

① DS-DHSG cable(EHS-3) : RJ-45(8P8C) to RJ-45(8P8C) and RJ-9(4P4C)



Connection Diagram

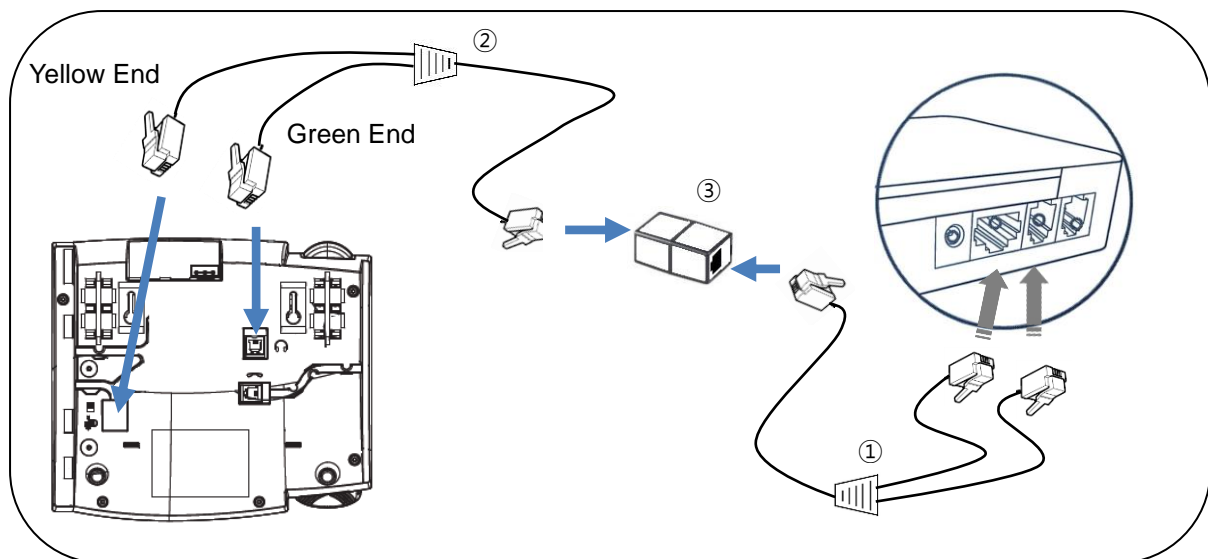

Note : Aastra DHSG cable kit is available from your Aastra reseller

- ① DS-DHSG cable(EHS-3) : RJ-45(8P8C) to RJ-45(8P8C) and RJ-9(4P4C)
- ② Aastra DHSG cable
- ③ RJ-45 Coupler

Note :

1. Audio mode needs to be set to "Headset/Speaker" mode manually.
(Options->Preferences->Set Audio->Audio Mode->Headset/Speaker)
2. For full headset functionality, disable the "Goodbye Key Cancels Incoming Call" parameter.
Aastra Web UI: Basic Settings->Preferences->General

Alcatel EHS Setup guide



Connection Diagram

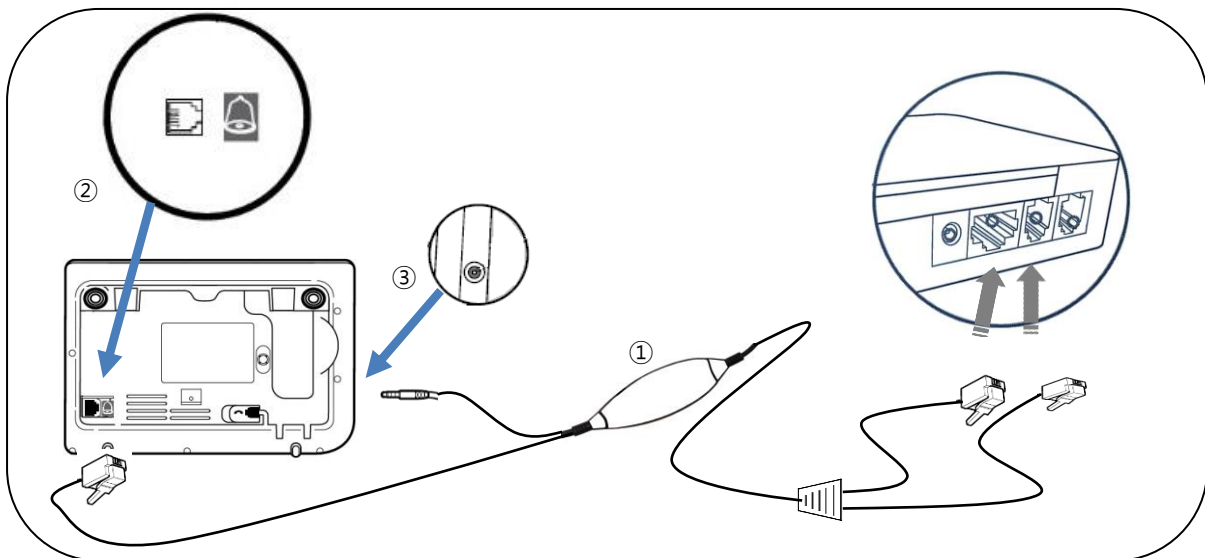

- ① MSH cable(EHS-7) : RJ-12(6P6C) and 3.5Ø plug to RJ-45(8P8C) and RJ-9(4P4C)
- ② EHS Port
- ③ Audio Port

Avaya EHS Setup guide

Avaya	Phones		
	1408	1416	1608
	1616	2410	5410
	6224D+M	6416D+M	
	9404	9408	9504
	9508	9608	9610
	9611	9620	9621
	9630	9640	9641
	9650	9570	

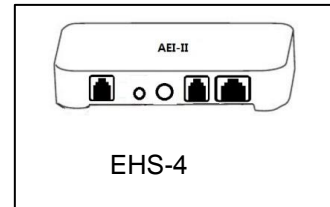

Connection Diagram

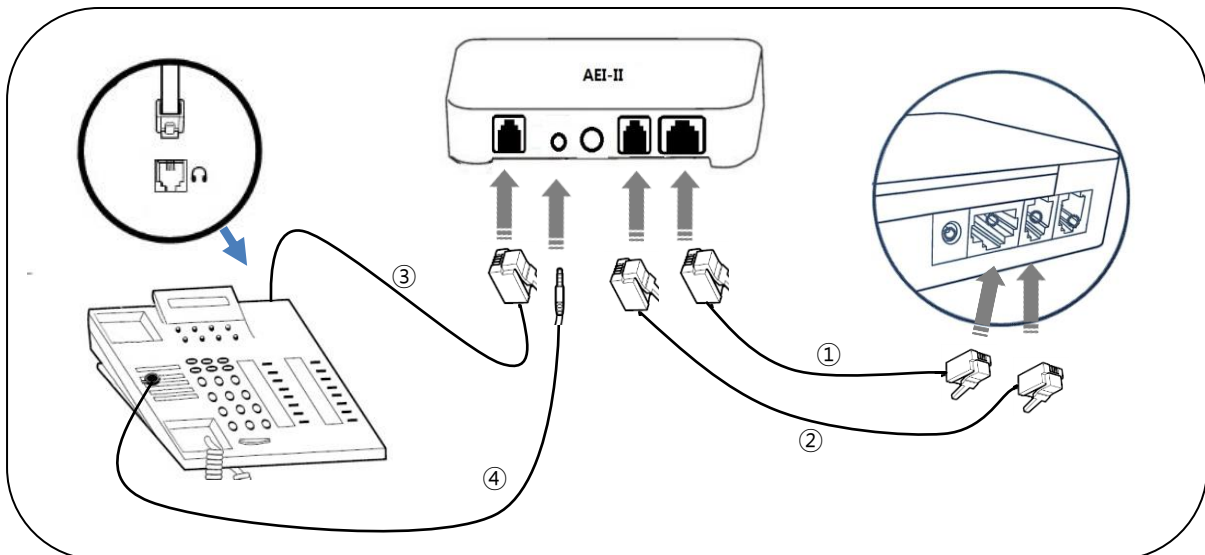

- ① : Power cable (RJ-45 to RJ-12)
- ② : Telephone cord (RJ-9 to RJ-9) Cable length : 600mm
- ③ : Telephone cord (RJ-9 to RJ-9) Cable length : 300mm
- ④ : External Microphone for ring detection

Position of Telephone compatibility Switch : Set to '1'

Compatibility switch is located on left side of the base unit.

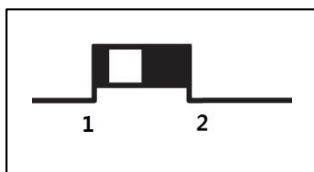

Cisco EHS Setup guide



Connection Diagram

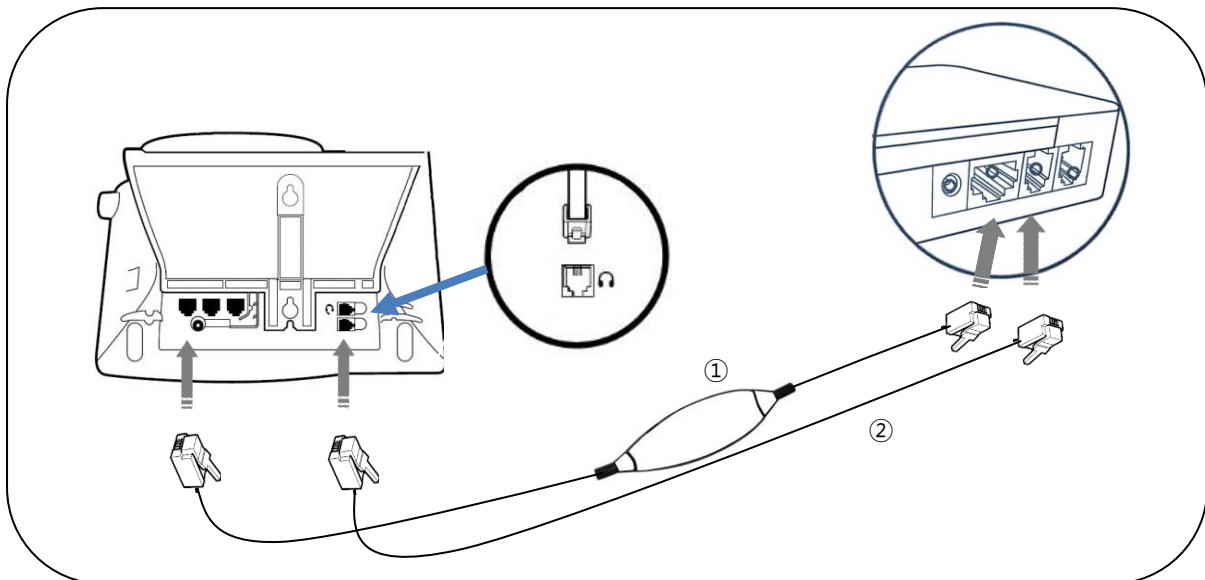

- ① : HHC EHS Adapter (EHS-2) : RJ-45 to RJ-12
- ② : Telephone cord (RJ-9 to RJ-9) Cable length : 600mm

Position of Telephone compatibility Switch : Set to '2'
Compatibility switch is located on left side of the base unit.

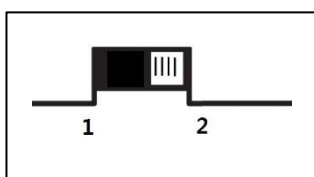



Connection Diagram

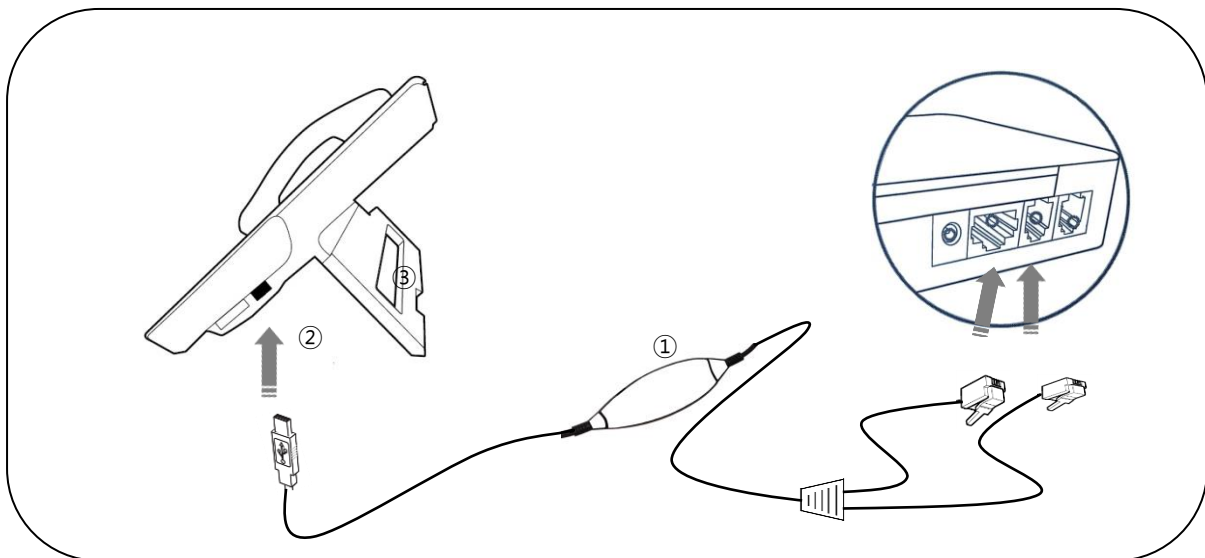

- ① : HHC EHS Adapter (EHS-12) : RJ-45(8P8c) and RJ-9(4P4C) to USB A-type Plug
- ② : USB Port(A-type Female)

Ericsson-LG EHS Setup guide

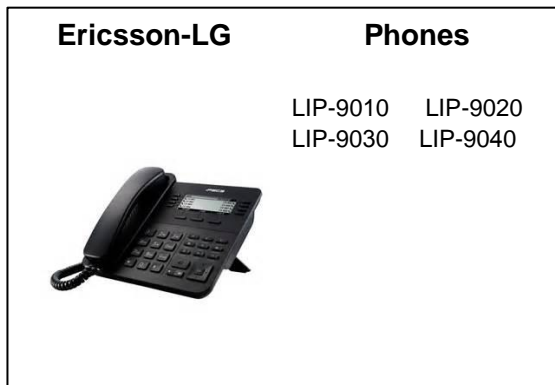

Need Ericsson-LG EHS Kit

Connection Diagram

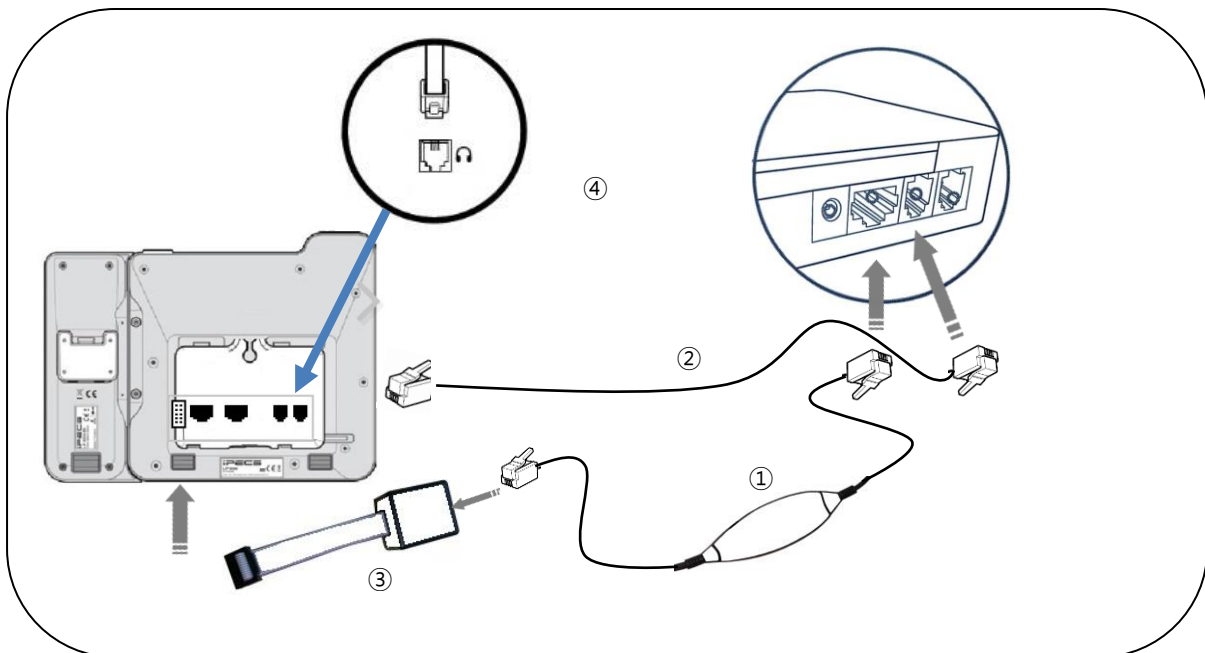

- ① LG EHS Adapter (EHS-11) : RJ-45(8P8C) to RJ-45(8P8C)
- ② Headset Port
- ③ EHS Adapter : supplied from Ericsson-LG reseller
- ④ Audio cables : RJ-9(4P4C) to RJ-9(4P4C)

Panasonic EHS setup guide

Panasonic	Phones
	NT553 NT556
	DT543 DT546
	NT543 HDV230
	HDV330 HDV430



Connection Diagram

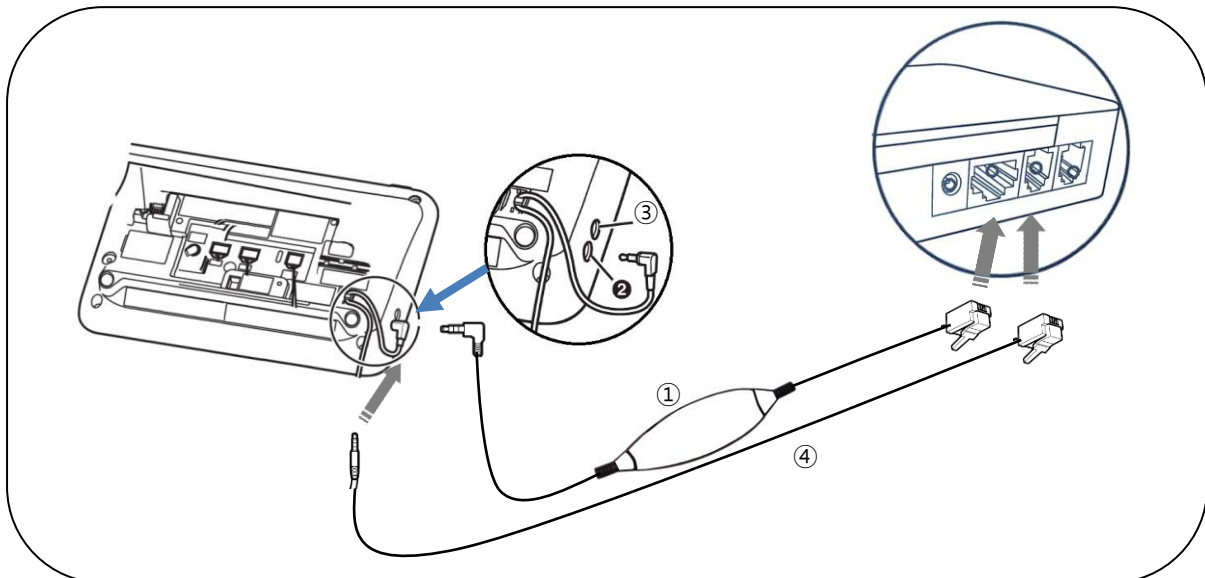

- ① Panasonic EHS Adapter (EHS-1) : RJ-45(8P8c) to 3.5ØPlug (3 poles)
- ② Headset Port
- ③ EHS Port
- ④ Audio cables : RJ-9(4P4C) to 3.5ØPlug (3 poles)

Polycom EHS Setup guide

Polycom	Phones	
	IP 320	IP 321
	IP 330	IP 331
	IP 335	IP 435
	IP 450	IP 550
	IP 560	IP 650
	IP 670	
	VVX 300	VVX 310
	VVX 400	VVX 410
	VVX 500	VVX 600
	VVX 1500	



Connection Diagram

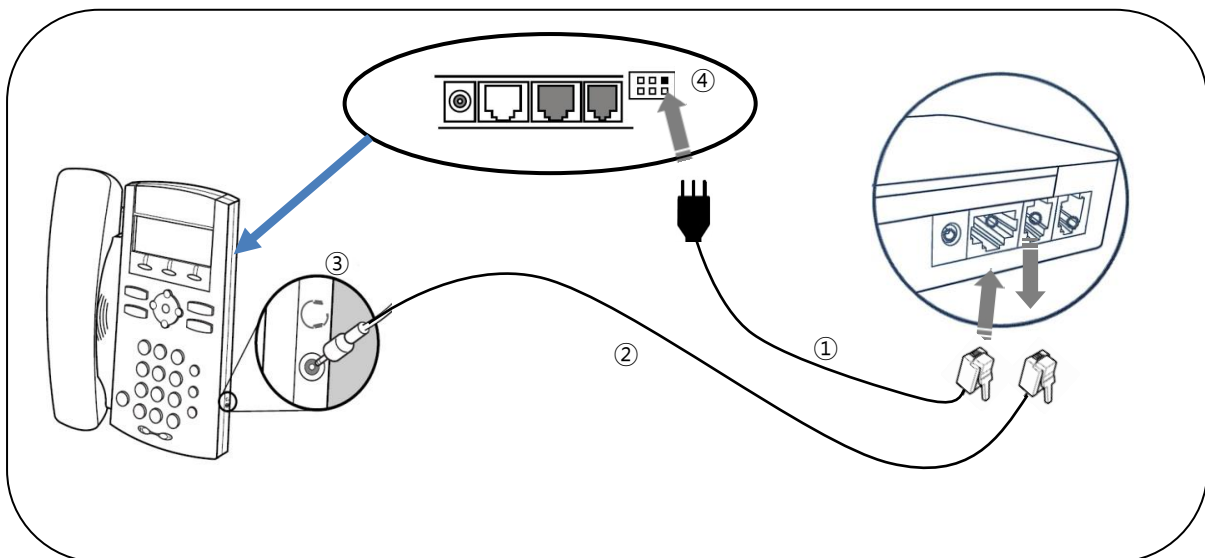

- ① Polycom EHS Adapter (EHS-5) : RJ-45(8P8c) to 5-Pin Plug
- ② Audio cables : RJ-9(4P4C) to 2.5ØPlug (3 poles)
- ③ Headset Port
- ④ EHS Port

Connection Diagram

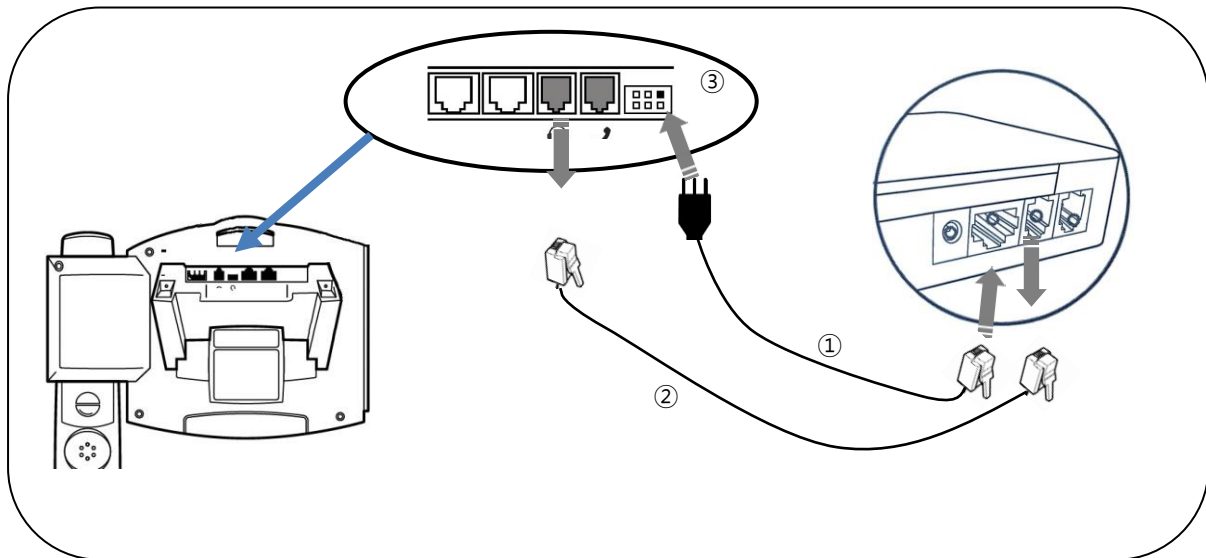

- ① Polycom EHS Adapter (EHS-5) : RJ-45(8P8c) to 5-Pin Plug
- ② Audio cables : RJ-9(4P4C) to RJ-9(4P4C)
- ③ EHS Port

Note 1: Phone must be running SIP application 3.1 or higher and BootROM 4.1.0 or later.

Note 2: Phone must be running SIP application 3.0.2 or higher and BootROM 4.1.0 or later.

Note 3: Phone must be running SIP application 3.1.0 Rev C or higher and BootROM 4.1.0 or later.

Note 4: 2.5mm headset port connector requires Audio cable.

Instruction

Access your Polycom phone menu and change the headset settings to "Jabra Mode" or "Jabra DHSG" based on the manufacturer's instructions for your specific model. Depending on your phone model, you may need to complete this step after connecting the EHS adapter. Typically, changing the settings requires that you access the "Basic," "Preferences," and "Headset" sections in the menu on your phone. Once "Analog Headset Mode" appears on the screen, use the up and down arrows to select the Jabra Mode and then choose "Back," "Exit" or "Menu" to return to the main screen.

ShoreTel EHS Setup guide

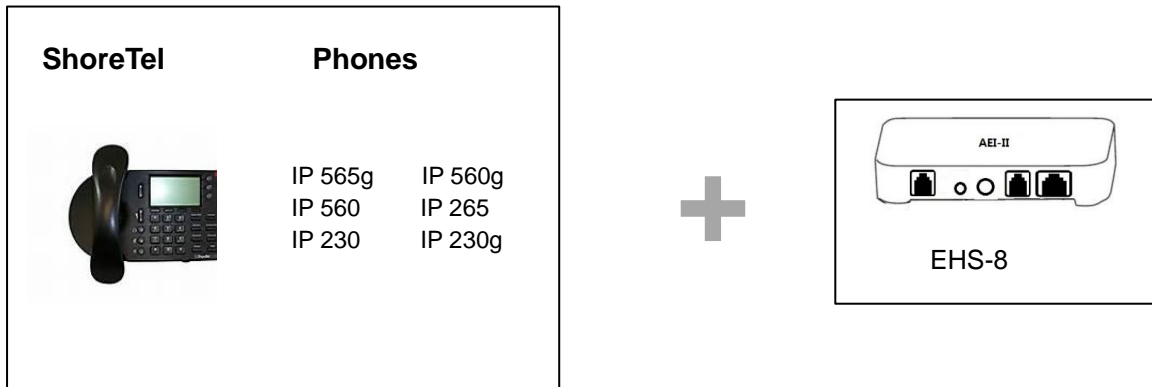

Connection Diagram

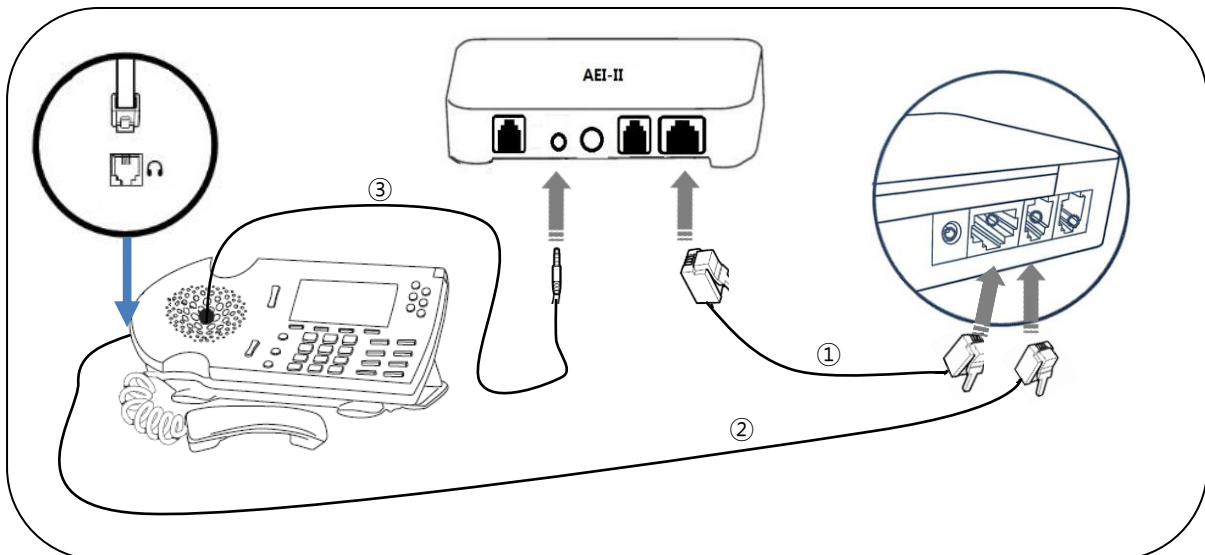

- ① Power cable (RJ-45 to RJ-12)
- ② Telephone cord (RJ-9 to RJ-9) : Cable length : 600mm
- ③ External Microphone : For ring detection

Siemens/Unify EHS Setup guide

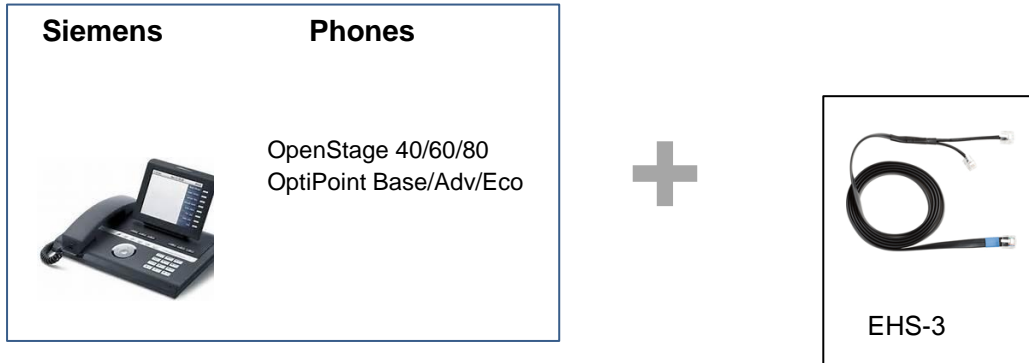

Connection Diagram (For OpenStage series)

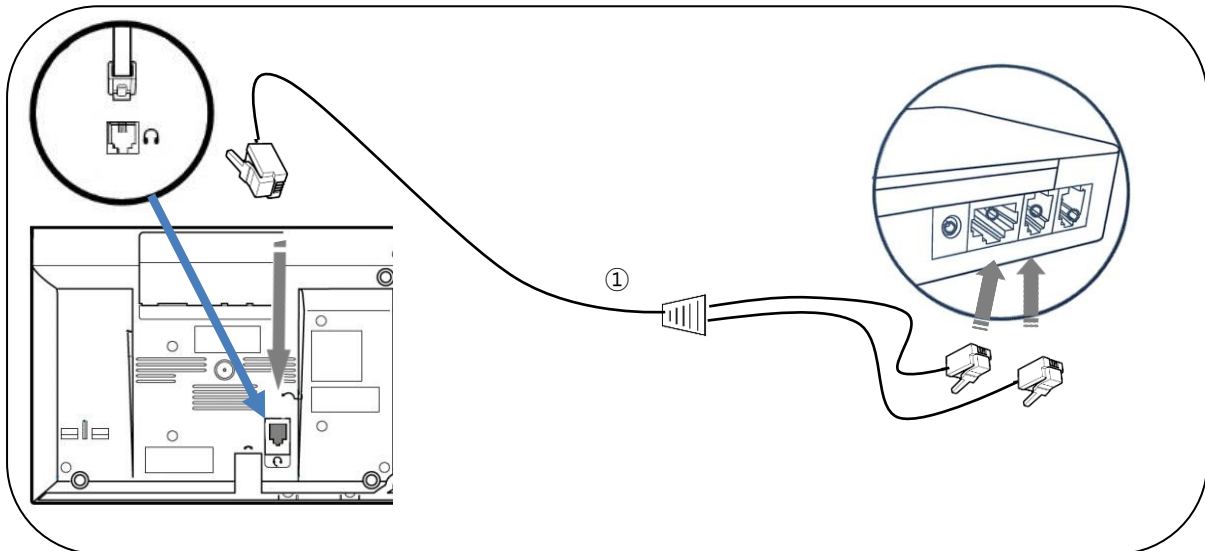

① DS-DHSG EHAS adpter (EHS-3) : RJ-45(8P8C) and RJ-9(4P4C) to RJ-45(8P8C)

Connection Diagram (For OpenScape and Optipoint series)

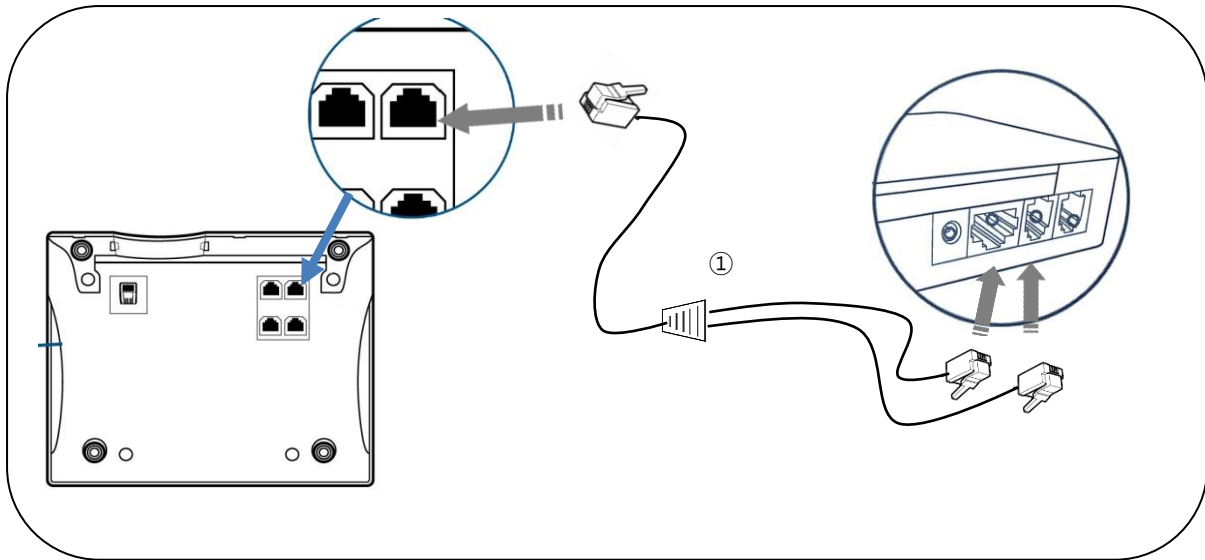

① DS-DHSG EHAS adapter (EHS-3) : RJ-45(8P8C) and RJ-9(4P4C) to RJ-45(8P8C)

SNOM EHS Setup guide

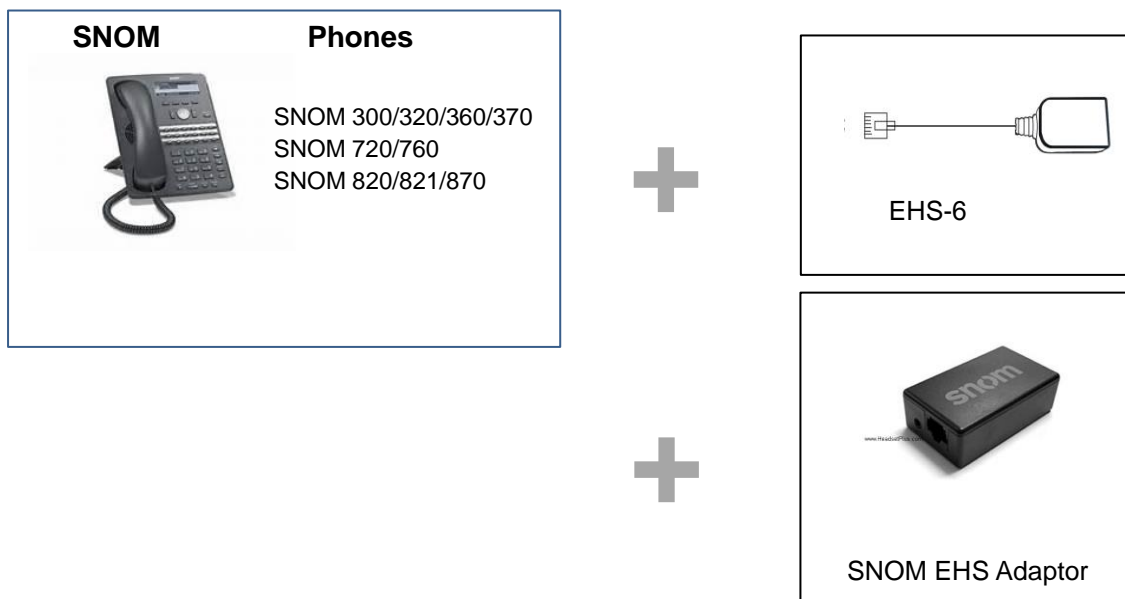

Connection Diagram

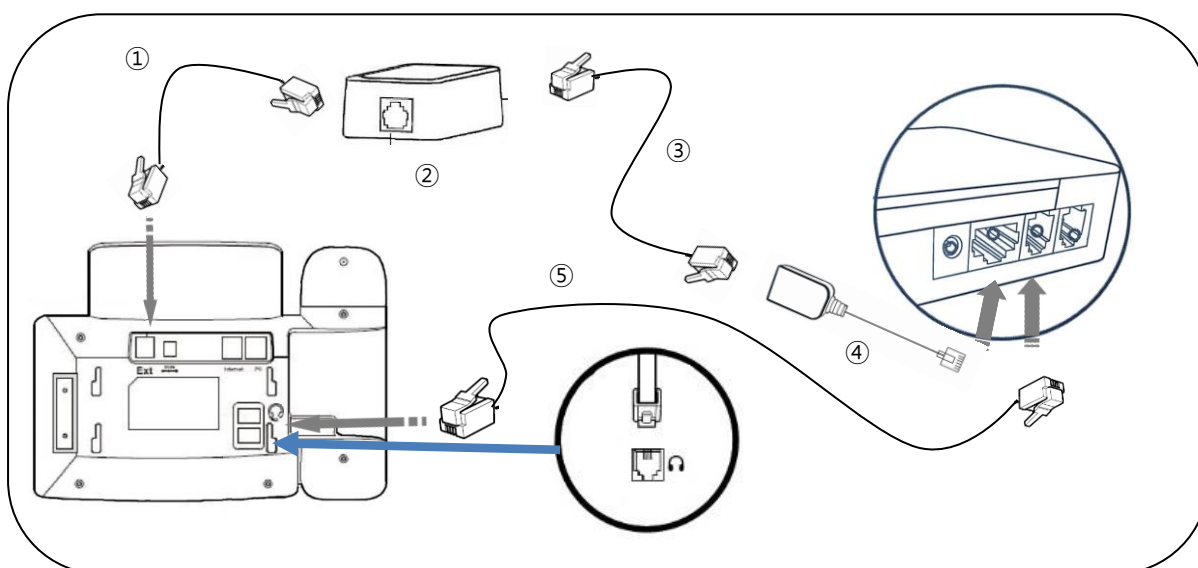

- ① Cord (RJ-12 to RJ-12) supplied by manufacturer of EHS Adapter – snom 3xx/snom 820
Cord (RJ-45 to RJ-12) supplied by manufacturer of EHS Adapter – snom 821/snom 870
- ② EHS Adapter supplied by Snom
- ③ Cord (RJ-45 to RJ-45) supplied by manufacturer of EHS Adapter
- ④ EHS Gender
- ⑤ Telephone cord (RJ-9 to RJ-9) : Cable length 600mm

Snom 3xx: 7.3.30 + bootloader 1.1.3u and higher

Snom 7xx: 8.7.3.6 and higher

Snom 8xx: 8.4.32 and higher

Toshiba EHS Setup guide

Toshiba	Phones	
	IP5022-SD	IP5122-SD
	IP5122-SDC	IP5131-SDL
	IP5132-SD	
	DP5022-SD	DP5022-SDM
	DP5032-SD	DP5122-SD
	DP5130-FSDL	DP5130-SDL
	DP5132-SD	

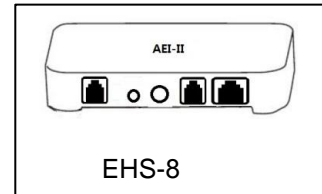

Connection Diagram

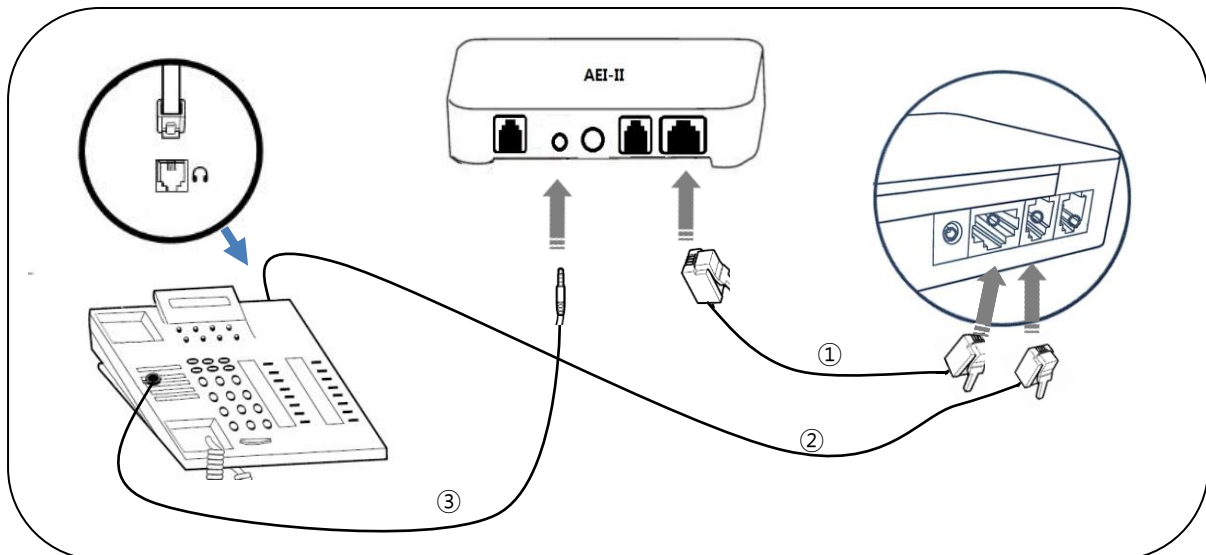

- ① Power cable (RJ-45 to RJ-12)
- ② Telephone cord (RJ-9 to RJ-9) : Cable length : 600mm
- ③ External Microphone : For ring detection

Yealink EHS Setup guide

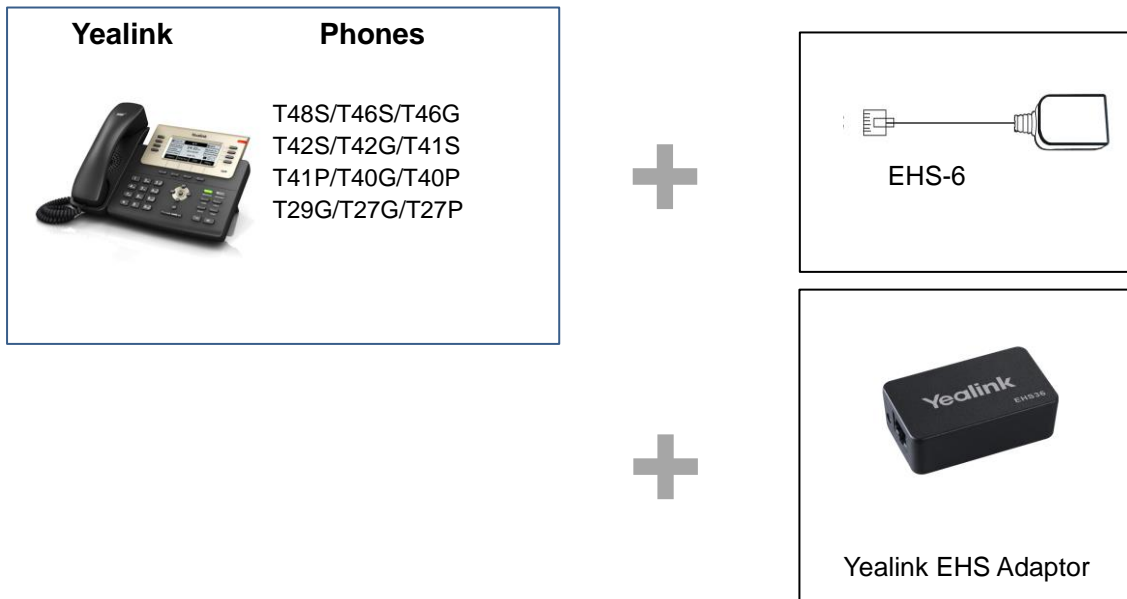

Connection Diagram

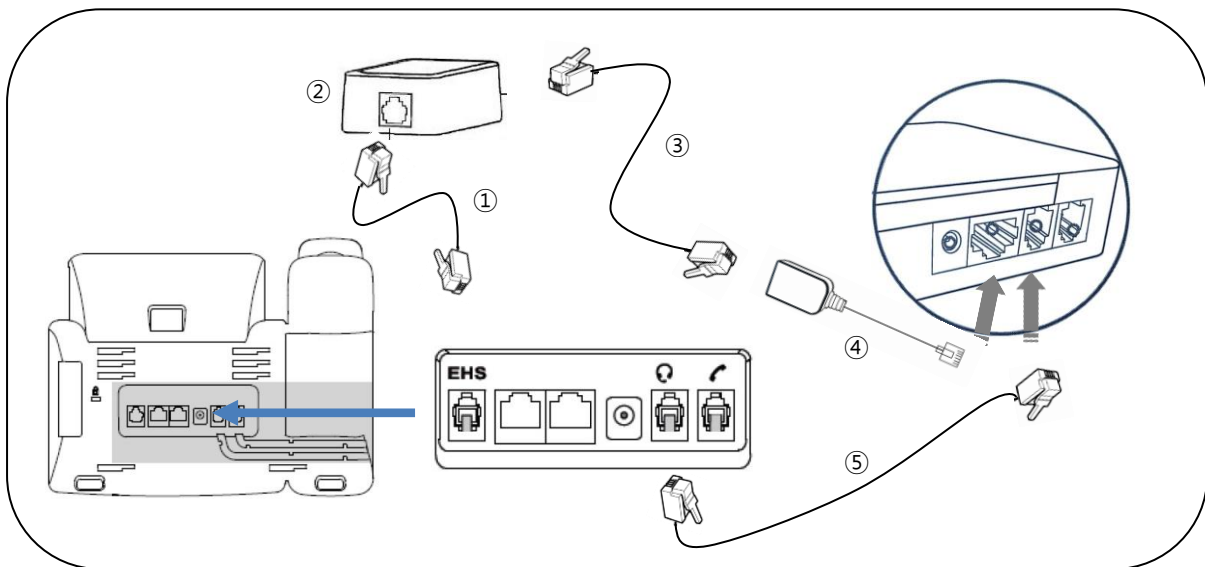

- ① Cord (RJ-12 to RJ-12) supplied by manufacturer of EHS Adapter
- ② EHS Adapter supplied by Yealink
- ③ Cord (RJ-45 to RJ-45) supplied by manufacturer of EHS Adapter
- ④ EHS Gender
- ⑤ Telephone cord (RJ-9 to RJ-9) : Cable length 600mm

