



# SAMSUNG

Enterprise IP Solutions

# OfficeServ

## User Guide for 5000D Series Phones

ITP-5021D

ITP-5014D

DS-5021D

DS-5014D



TELECOMS



## **Publication Information**

Samsung Telecoms reserves the right without prior notice to revise information in this publication for any reason.

Samsung Telecoms also reserves the right without prior notice to make changes in design or components of equipment as engineering and manufacturing may warrant.

## **Disclaimer**

Samsung Telecoms is not responsible for errors or problems arising from customers not installing, programming or operating their Samsung systems as described in this manual.

## **Copyright 2004 Samsung Telecoms (UK) Limited**

All rights reserved. No part of this manual may be reproduced in any form or by any means – graphic, electronic or mechanical, including recording, taping, photocopy or information retrieval system – without express written permission of the publisher of this material.

Part No.: 18933

Version 1.0



ELECTRONICS

# EU Declaration of Conformity (RTTE)

**Samsung Electronics Co., Ltd.**

259 Gongdan-Dong, Gumi-City Kyungbuk, Korea, 730-030

(factory name, address)

declare under our sole responsibility that the product

**Digital Keyphone System "iDCS500 / OfficeServ500"**

to which this declaration relates is in conformity with

RTTE Directive 1999/5/EC ( Annex II )  
Low Voltage Directive 73/23/EEC  
EMC Directive 89/336/EEC:92/31/EEC



By application of the following standards

.....  
RTTE: TBR4: November 1995 incorporating TBR4/A1: December 1997  
.....

LVD: EN60950: 2000 (IEC 60950, Third Edition, 1999)  
.....

EMC: EN55022 : 1998, EN61000-3-2:1995 Inc A1/A2:1998 + A14:2000\*,  
.....

EN61000-3-3:1995, EN61000-4-2:1995 98, EN61000-4-3:1996,  
.....

EN61000-4-4:1995, EN61000-4-5:1995, EN61000-4-6:1996,  
.....

EN61000-4-11:1994, AS/NZS3548:1995  
.....

**(Manufacturer)**

Samsung Electronics Co., Ltd  
259, Gongdan-Dong, Gumi-City  
Kyungbuk, Korea, 730-030

.....  
2003-05-19 TE Jang

(place and date of issue)

.....  
Tae-eok Jang / General Manager

(name and signature of authorized person)

**(Representative in the EU)**

Samsung Electronics Euro QA Lab.  
Blackbushe Business Park  
Saxony Way, Yateley, Hampshire  
GU46 6GG, UK

.....  
2003-05-18 IS Lee

(place and date of issue)

.....  
In-Seop Lee / Manager

(name and signature of authorized person)

## ABOUT THIS GUIDE

This User Guide provides instructions for installing and operating the following Samsung telephones with the Samsung Enterprise IP Solutions OfficeServ system.

- ITP-5000D Series IP phones (ITP-5021D and ITP-5014D 2-line LCD IP phones)
- DS-5000D Series phones (DS-5021D and DS-5014D 2-line LCD digital phones)

Please take the time to read this guide to familiarise yourself with the features of your phone. Keep the guide handy: you may need to look up instructions for infrequently used features.

## SAFETY PRECAUTIONS



For your safety and to ensure correct operation of your phone, note carefully the following important precautions before you begin the installation.

### **Avoid placing objects containing water near the phone.**

Do not put objects that contain water such as vases, cups, cosmetics, and medicines near the phone. Moisture in the phone may cause fire and electric shocks.

### **Do not install the phone in the following locations:**

- Direct sunlight or near a heater
- Humid areas or where water flows
- Areas of extreme or volatile changes in temperature.
- Dusty or dirty areas

### **Use a soft dry cloth to clean the phone.**

Do not use chemical solvents such as wax, benzene, alcohol, thinner, aerosol, lubricant, or detergent to clean your phone.

**Do not disassemble or attempt to repair the phone yourself.**

If a repair is needed, please contact your authorised Samsung dealer.

**Also, if installing an ITP-5000D Series phone:****Take care not to connect the network LAN cable to the PC connection jack.**

If the LAN cable connected to the network is connected to the PC connection jack, both telephone and PC communications will be disabled.

**Use the AC power adapter supplied with the phone.**

If an alternative power adapter is used, this may result in serious damage and voids the warranty.

**Do not turn off power to the phone while upgrading the Bootrom.**

If you turn off power to the phone during the upgrade process, the phone will not function correctly.

<p><b>If any items are missing or damaged when you open the phone packaging, contact your authorised Samsung dealer for advice.</b></p>
---

# Contents

<b>Chapter 1</b>	<b>Installing Your ITP- or DS-5000D Series Phone .....</b>	<b>1-1</b>
	<b>ITP-5000D Series IP Phone .....</b>	<b>1-1</b>
	Checking the Supplied Components.....	1-1
	Connectors on the IP Phone.....	1-2
	Installing the IP Phone .....	1-2
	<b>DS-5000D Series Digital Phone .....</b>	<b>1-6</b>
	Checking the Supplied Components.....	1-6
	Installing the Phone.....	1-7
<b>Chapter 2</b>	<b>Setting the Working Environment for ITP-5000D Series IP Phones .....</b>	<b>2-1</b>
	<b>Overview of Environment Settings Mode .....</b>	<b>2-1</b>
	<b>Starting the Phone .....</b>	<b>2-2</b>
	<b>Setting Parameters .....</b>	<b>2-3</b>
	<b>Verifying Settings and Rebooting .....</b>	<b>2-7</b>
<b>Chapter 3</b>	<b>Things You Should Know .....</b>	<b>3-1</b>
	<b>Front Panel of Phone.....</b>	<b>3-1</b>
	Dial (Keypad) Buttons .....	3-3
	Programmable Buttons .....	3-3
	Volume Buttons .....	3-4
	Redial Button .....	3-4
	Conference Button .....	3-4
	Transfer Button .....	3-4
	Hold Button .....	3-4
	Speaker Button .....	3-4
	Navigation Buttons.....	3-5
	LCD Panel.....	3-6
	Scroll Button.....	3-6
	Soft Buttons.....	3-6
	Microphone .....	3-7
	Phone Status Indicator .....	3-7

---

<b>Chapter 4 Basic Features .....</b>	<b>4-1</b>
<b>Button LEDs .....</b>	<b>4-1</b>
<b>Phone Status Indicator.....</b>	<b>4-1</b>
<b>Using Feature Codes.....</b>	<b>4-2</b>
<b>Selecting Programmed Functions .....</b>	<b>4-2</b>
<b>Assigning Button Values (Extenders) .....</b>	<b>4-3</b>
<b>Controlling Volume Levels.....</b>	<b>4-4</b>
Handset Volume.....	4-5
Speakerphone Volume.....	4-5
Ringer Volume .....	4-6
<b>Selecting the Ring Tone .....</b>	<b>4-6</b>
<b>Changing the Phone Passcode.....</b>	<b>4-7</b>
<b>Setting the Answering Mode for Intercom Calls.....</b>	<b>4-8</b>
<b>Switching Headset/Handset Mode .....</b>	<b>4-10</b>
<b>Enabling/Disabling Key Confirmation Tone.....</b>	<b>4-11</b>
<b>Hot Keypad .....</b>	<b>4-12</b>
<b>Dialling by Directory Name .....</b>	<b>4-13</b>
<b>Assigning/Changing Your Extension Name.....</b>	<b>4-14</b>
<b>Making Intercom Calls .....</b>	<b>4-15</b>
Calling an Extension Number .....	4-15
Busy Extension Callback .....	4-16
Busy Extension Camp-On.....	4-17
Calling Your System Operator.....	4-17
<b>Answering Intercom Calls .....</b>	<b>4-18</b>
Answering Intercom Calls in Ring Mode.....	4-18
Answering Intercom Calls in Voice Announce Mode .....	4-18
Answering Intercom Calls in Automatic Answer Mode .....	4-19
<b>Making Outside Calls .....</b>	<b>4-20</b>
Calling Outside Lines (Overview).....	4-20
Authorisation Codes and Account Codes .....	4-20
Calling Outside Lines Using the Handset .....	4-21
Calling Outside Lines Using the Speakerphone .....	4-22
Making a New Call Without Releasing the Line (Recall Dial Tone) .....	4-22
Busy Line Queuing With Callback .....	4-23
Cancelling a Callback .....	4-24
<b>Answering Outside Calls .....</b>	<b>4-25</b>
Universal Answer .....	4-25

<b>Holding a Call</b> .....	<b>4-25</b>
System Hold.....	4-26
Automatic Hold.....	4-26
Exclusive Hold .....	4-28
Consultation Hold.....	4-29
Hold Recall.....	4-30
Retrieving Calls Held at Another Extension.....	4-30
<b>Parking Calls</b> .....	<b>4-31</b>
<b>Transferring Calls</b> .....	<b>4-32</b>
Transfer With Camp-On.....	4-33
Transfer To Voice Mail.....	4-33
Call Waiting.....	4-34
<b>Chapter 5 Program Menus</b> .....	<b>5-1</b>
<b>Navigation Buttons</b> .....	<b>5-1</b>
Menu Button.....	5-1
Send Button .....	5-1
End Button .....	5-2
Cancel Button .....	5-2
Enter Button .....	5-2
Direction (Arrow) Buttons.....	5-2
<b>Main Menu</b> .....	<b>5-3</b>
How to Select Menu Items.....	5-3
<b>Viewing and Redialling Recently Called Numbers</b> .....	<b>5-4</b>
<b>Viewing and Calling Recently Received Numbers</b> .....	<b>5-5</b>
<b>Viewing and Calling Personal Speed Dial Numbers</b> .....	<b>5-5</b>
<b>Viewing and Calling System Speed Dial Numbers</b> .....	<b>5-6</b>
<b>Viewing and Calling Personal Speed Dial Numbers By Name</b> .....	<b>5-7</b>
<b>Viewing and Calling System Speed Dial Numbers By Name</b> .....	<b>5-8</b>
<b>Viewing and Calling Extension Numbers by Name</b> .....	<b>5-9</b>
<b>Setting Call Forward Type and Destination</b> .....	<b>5-10</b>
<b>Setting Reminder Alarms</b> .....	<b>5-12</b>



<b>Chapter 6</b>	<b>Dialling Features .....</b>	<b>6-1</b>
	Speed Dialling .....	6-1
	Redial an Outside Number .....	6-7
	Automatic Redial/Retry .....	6-8
	Pulse to Tone Changeover .....	6-8
	Conference Calls .....	6-9
<b>Chapter 7</b>	<b>Call Pickup.....</b>	<b>7-1</b>
	Station Call Pickup .....	7-1
	Group Call Pickup.....	7-2
<b>Chapter 8</b>	<b>Call Forwarding.....</b>	<b>8-1</b>
	Forwarding All Calls .....	8-2
	Forward Busy.....	8-3
	Forward No Answer.....	8-3
	Forward Busy/No Answer .....	8-4
	Forward DND.....	8-4
	Forward Follow Me .....	8-5
	Viewing and Changing Forward Options .....	8-6
<b>Chapter 9</b>	<b>Paging and Messaging .....</b>	<b>9-1</b>
	Internal Page .....	9-1
	External Page.....	9-2
	All Page.....	9-3
	Meet Me Page: MMPG.....	9-4
	Call Park and Page .....	9-5
	Rejoining a Page.....	9-6
	Setting a Message Waiting Indication .....	9-7
	Replying to Message Waiting Indications .....	9-8
	Cancelling Messages .....	9-10
	Programmed Messages .....	9-10

<b>Chapter 10</b>	<b>Special Features.....</b>	<b>10-1</b>
	Do Not Disturb .....	10-1
	Muting Your Phone .....	10-3
	Background Music.....	10-3
	Alarm Features.....	10-4
	Using the Door Phone .....	10-8
	Executive/Secretary Hot Line .....	10-9
	Group Listening .....	10-10
	Locking and Unlocking Your Phone .....	10-11
	Off-Hook Voice Announcements (OHVA) .....	10-12
	In Group / Out of Group .....	10-14
	Call Duration Timer.....	10-15
	Ring Preference .....	10-17
<b>Chapter 11</b>	<b>Caller Identification (CLIP) .....</b>	<b>11-1</b>
	Viewing Number or Name of Caller.....	11-1
	Viewing Next Caller CLIP .....	11-2
	Storing a Caller Number.....	11-2
	Calling a Stored Number.....	11-3
	Storing a Caller Number as a Speed Dial Number. ....	11-3
	Viewing CLIP for Calls on Hold or Parked .....	11-3
	Viewing CLIP for Previous Calls .....	11-4
<b>Appendix: Additional Information.....</b>		<b>A-1</b>
	System Feature Codes.....	A-1
	Programmed Messages .....	A-2
	Entering Characters on the LCD Panel .....	A-3

## List of Figures

Figure 1.1	Contents of ITP-5000D Series IP Phone Package .....	1-1
Figure 1.2	Base of ITP-5000D Series IP Phone.....	1-2
Figure 1.3	Contents of DS-5000D Series Phone Package .....	1-6
Figure 1.4	Base of DS-5000D Series Phone.....	1-7
Figure 3.1	Front Panel of the ITP- and DS-5014D Phone .....	3-1
Figure 3.2	Front Panel of the ITP- and DS-5021D Phone .....	3-2
Figure 5.1	Navigation Buttons .....	5-1
Figure 6.1	Buttons A–F .....	6-1

# Chapter 1 Installing Your ITP- or DS-5000D Series Phone

This chapter explains how to install your phone. Refer to the appropriate section for **ITP-5000D Series IP Phone** or **DS-5000D Series Digital Phone** in this chapter for the phone you are installing.

## ITP-5000D Series IP Phone

### Checking the Supplied Components

**First, open and check the package you have received. If any of the parts is missing or damaged, contact your dealer immediately.**

The package supplied with the IP phone includes the following items:

- IP phone
- IP phone stand
- Handset
- LAN cable (for PC connection)
- Power adapter (Input: AC 240V 50Hz, Output : DC 24V 0.4A)

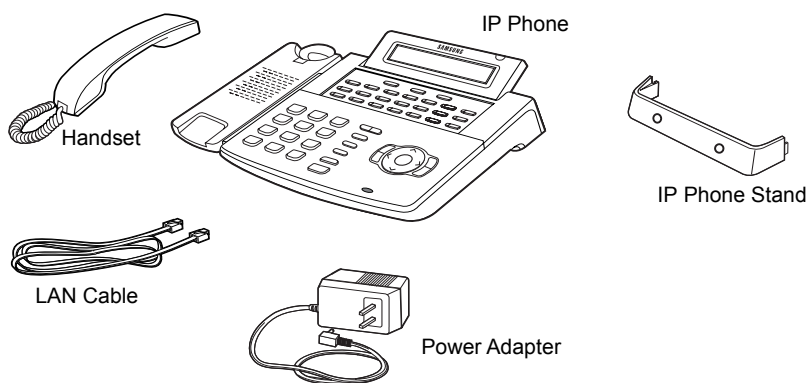

**Figure 1.1 Contents of ITP-5000D Series IP Phone Package**

## Connectors on the IP Phone

The base of the phone contains a handset connection jack, power connection jack, LAN connection jack, and a PC connection jack.

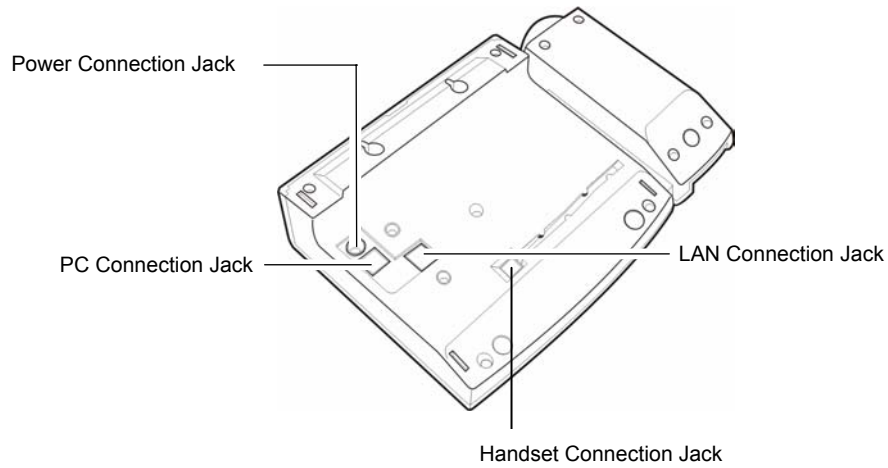

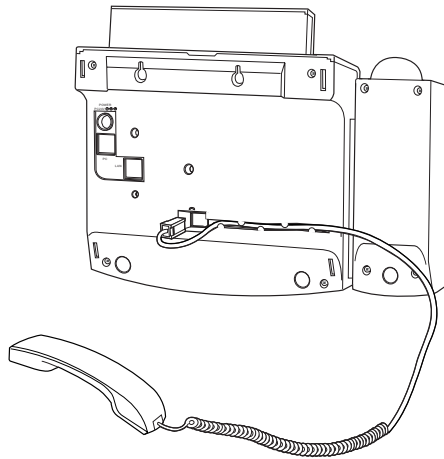

Figure 1.2 Base of ITP-5000D Series IP Phone

## Installing the IP Phone

1. Plug the handset cord into the jack marked with the  symbol and push the cord inside the recess to secure it.



2. Connect the LAN cable from the network to the LAN connection jack.

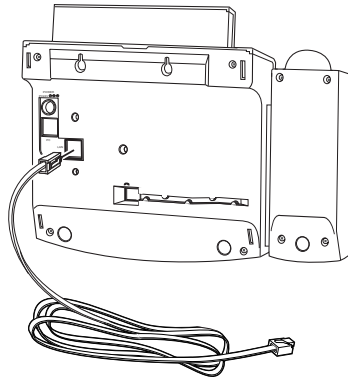

3. Connect the LAN cable from the PC's network card to the PC connection jack.

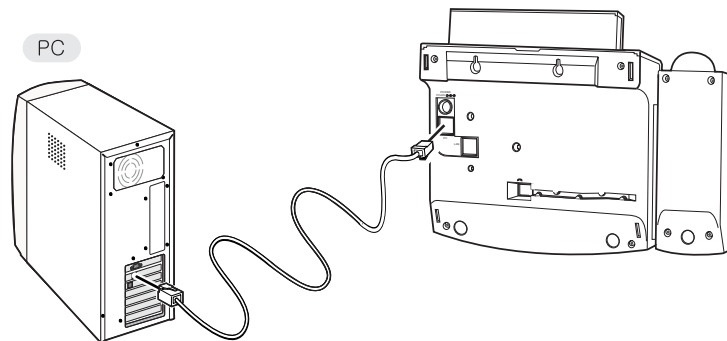

CAUTION

Take care not to connect the LAN cable from the network to the PC connection jack on the phone.

Otherwise, neither the phone nor the PC connection will function.

4. Connect the power adapter cable to the power connection jack. Do not connect the cable to the power outlet yet.

The power specification is as follows.

Input : AC 240V 50Hz

Output : DC 24V 0.4A

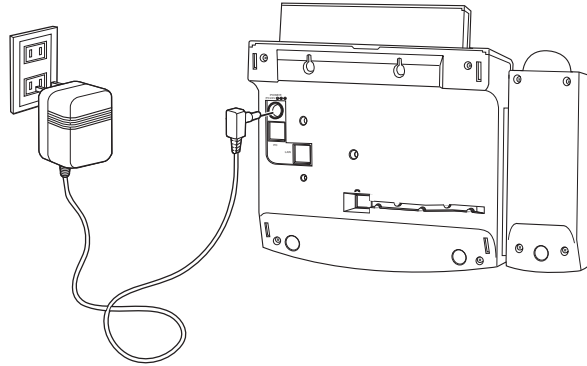

Use only the supplied adapter cable. Using any other cable may cause serious damage and will void the warranty.

5. Insert the phone stand.
  - **If using as a desk-phone**, insert the phone stand into the slots located in the *upper* section of the base.

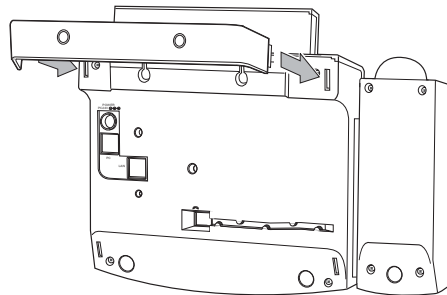

- **If using as a wall-mounted phone**, insert the support into the slots located in the *lower* section of the base.

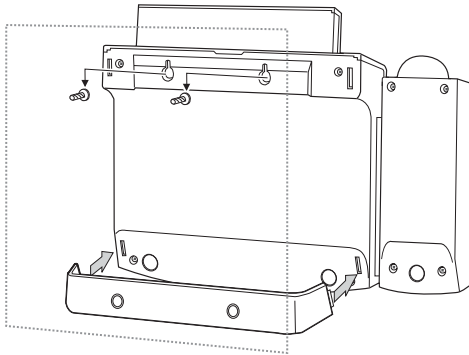

- Use the two mounting holes in the upper section of the phone body for wall mounting the phone on screws inserted into the wall.
- The handset hook should also be changed so that the handset is secure when mounted on the wall. Push out the handset hook from the holder, turn it through 180° and push it back into the holder.

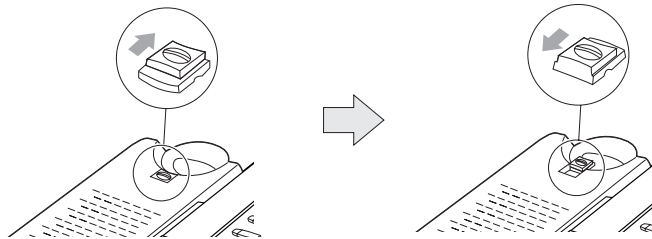

Installation is complete. Now set up the ‘working environment’ for the phone as described in **Chapter 2**.



## DS-5000D Series Digital Phone

### Checking the Supplied Components

First, open and check the package you have received. If any of the parts is missing or damaged, contact your dealer immediately.

The package supplied with the phone includes the following items:

- Digital phone
- Phone stand
- Handset
- Line cord

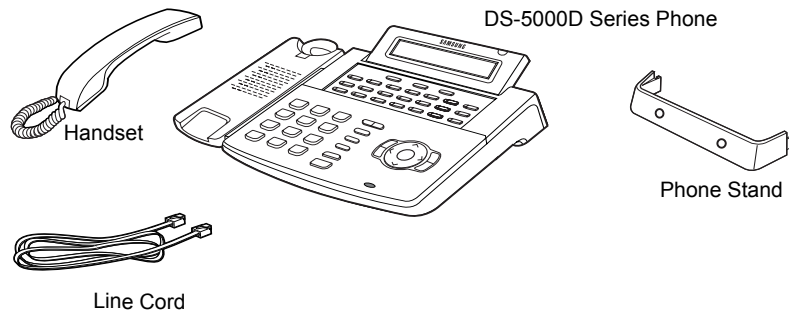
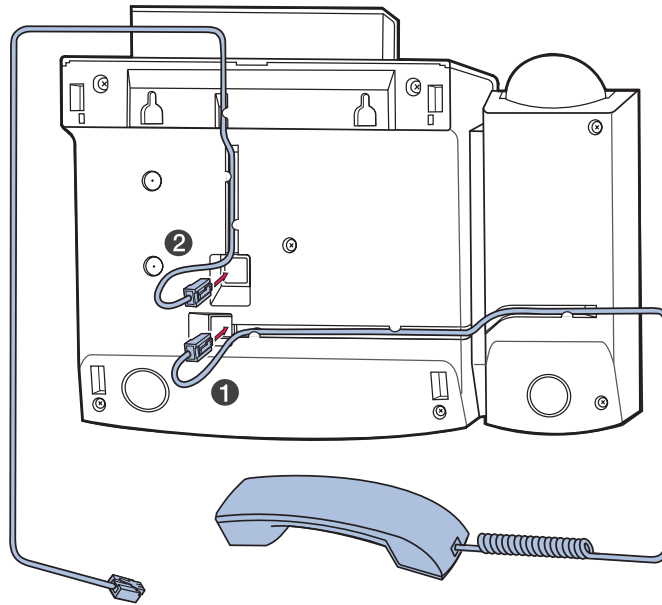

Figure 1.3 Contents of DS-5000D Series Digital Phone Package

## Installing the Phone

The base of the phone contains ❶ a handset connection jack and ❷ a line cord connection jack.



**Figure 1.4 Base of DS-5000D Series Digital Phone**

1. Plug the handset cord into the handset jack (marked with the 📞 symbol) and push the cord inside the recess to secure it.
2. Plug the line cord into the line cord jack and push the cord inside the recess to secure it. Plug the other end of the line cord into the phone socket.

- **If using as a desk-phone**, insert the phone stand into the slots located in the *upper* section of the base.

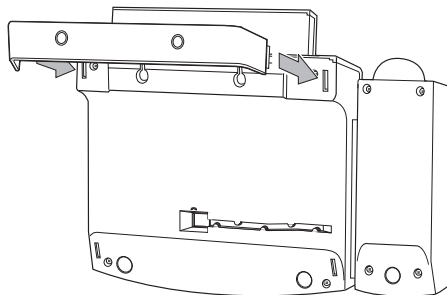

- **If using as a wall-mounted phone**, insert the support into the slots located in the *lower* section of the base.

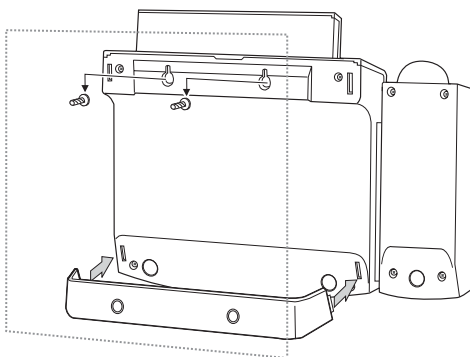

- Use the two mounting holes in the upper section of the phone body for wall mounting the phone on screws inserted into the wall.

- The handset hook should also be changed so that the handset is secure when mounted on the wall. Push out the handset hook from the holder, turn it through 180° and push it back into the holder.

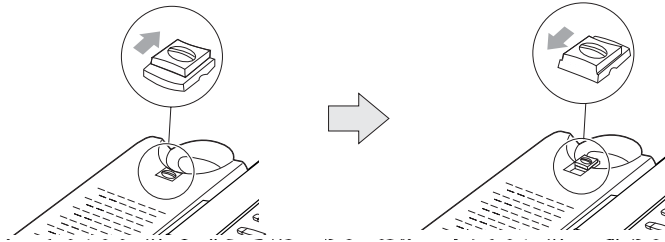

Installation is complete. Now find out what features your phone supports by going to **Chapter 3**.

## Chapter 2 Setting the Working Environment for ITP-5000D Series IP Phones

This chapter describes the procedure for starting (“booting”) an IP phone and setting the phone’s operating parameters.

### Overview of Environment Settings Mode

#### Menu Items

The menu structure for setting the phone’s environment is as shown below.

<u>TOP LEVEL</u>	<u>SUB-LEVEL</u>
1.Information	1.Version
	2.Network
	3.Load Option
	4.MAC address

2.Network	1.Mode
	2.IP*
	3.Netmask
	4.Gateway*

(\* Items 2 to 4 are only displayed when setting Manual IP)

3.Load & Upgrade	1.Load Option
	2.Upgrade Program
	3.Upgrade Bootrom
	4.Format

4.System	1.Password (Not used)
----------	--------------------------

5.Server	1.Server IP
	2.ID
	3.Password

6.Exit
--------

---

## Using the Buttons in Edit Mode

When entering the edit mode for any menu option, the cursor flashes and you can enter digits using the dial buttons [0] – [9] and [\*].

Button functions are listed in the table.

**Table 3.1 Using the Buttons in Edit Mode**

Button	Function
Left/Right arrow buttons on Navigation buttons	Erase contents or move cursor
Up/Down arrow buttons on Navigation buttons	Move between menu options
[Enter] button on Navigation buttons	Select menu or save current settings and exit
[End] button on Navigation buttons	Cancel entered settings and exit
Dial button [*]	Enter full-stop (.)
Dial button [0] – [9]	Select menu or enter numbers

## Starting the Phone

Connect the power adapter plug from the phone to the power outlet. The phone starts automatically.



**The power connection jack must be connected to a power outlet using the power adapter supplied with the phone.**

**Using a different adapter may result in serious damage and voids the warranty.**

Press the [Menu] button on the Navigation buttons. The phone enters the environment settings menu and displays the first two top level menus:

```
>1.Information
  2.Network
```

## Setting Parameters

The procedure for setting parameters takes you through the top level menus for Network, Load & Upgrade, System and Server.

### Network Menu

- Select '**2.Network**'. You see:

```
>1.Mode  
2.IP
```

- Select '**1.Mode**'. You see:

```
>1.Manual IP  
2.DHCP
```

- Select '**1.Manual IP**' to manually enter the IP, Subnet Mask, and Gateway IP addresses and continue with this section.

OR

Select '**2.DHCP**' to have the IP, Subnet Mask, and Gateway IP addresses automatically entered for you (and then go to the section **Load & Upgrade Menu** to continue).

If you selected '1.Manual IP' you see:

```
Manual IP  
Selected
```

followed by:

```
>1.Mode  
2.IP
```

- **Select '2.IP'**. You see:

```
Input IP Address
xxx.xxx.xxx.xxx
```

If the IP address is set, you can confirm the address displayed by pressing the [Enter] button. (If it is incorrect, use the left arrow button to delete the set address and use the dial buttons [0] to [9], and [\*] to enter the correct address, and press the [Enter] button to save and exit.)

OR

If the IP address is blank, use the dial buttons [0] to [9], and [\*] to set the address and press the [Enter] button to save and exit.

- **Select '3.Netmask'**. You see:

```
Input Netmask
xxx.xxx.xxx.xxx
```

If the subnet mask address is set, you can confirm the address displayed by pressing the [Enter] button. (If it is incorrect, use the left arrow button to delete the set address and use the dial buttons [0] to [9], and [\*] to enter the correct address, and press the [Enter] button to save and exit.)

OR

If the subnet mask address blank, use the dial buttons [0] to [9], and [\*] to set the address and press the [Enter] button to save and exit.

- **Select '4.Gateway'**. You see:

```
Input Def. Gateway
xxx.xxx.xxx.xxx
```

If the gateway address is set, you can confirm the address displayed by pressing the [Enter] button. (If it is incorrect, use the left arrow button to delete the set address and use the dial buttons [0] to [9], and [\*] to enter the correct address, and press the [Enter] button to save and exit.)



OR

If the gateway address is blank, use the dial buttons [0] to [9], and [\*] to set the address and press the [Enter] button to save and exit.

You have now completed the network parameter setup. Press the [End] button to return to the top level menu.

## Load & Upgrade Menu

The menu '3.Load & Upgrade' sets or modifies the phone's upgrade environment.

- Select '**3.Load & Upgrade**'. You see:

```
1.Load Option
2.Upgrade Program
```

- To designate where the phone's program is to be downloaded from, select '**1.Load Option**', then:

select '**1.File System**' to operate programs saved in the phone's flash memory,  
or

select '**2.TFTP down run**' to download programs saved in the designated TFTP server to the RAM memory of the phone.

- To upgrade the program, select '**2.Upgrade Program**' then '**1.TFTP server**'.

```
Input TFTP Server
xxx.xxx.xxx.xxx
```

Enter the IP address of the TFTP server from which the program should be downloaded. Press the [Enter] button to start the download.

- To upgrade the phone's bootrom select '**3.Upgrade Bootrom**' then '**1.TFTP server**'.

```
Input TFTP Server
xxx.xxx.xxx.xxx
```

Enter the IP address of the TFTP server from which the program should be downloaded. Press the **[Enter]** button to start the download.

The phone is rebooted after downloading the Bootrom program and the environment setup main menu appears.

- The '**[4. Format]**' option is used to delete previously saved programs. **Check if the program needs to be deleted before using this function.**

### **Server Menu (Setting System Authentication Information)**

Select the '**5.Server**' option on the main menu to set the IP address of the OfficeServ system connected to the IP phone and the authentication ID and password of the phone. (The ID and password are required if the OfficeServ system is set to request this information.) The following screen is displayed.

```
1.Server IP
2.ID
```

- To set/modify the IP address of the OfficeServ system, select '**1.Server IP**'. The following screen is displayed.

```
Input Server IP
xxx.xxx.xxx.xxx
```

The address is left blank if it is not set. Use the dial buttons [0] to [9], and [\*] to set the address and press the **[Enter]** button to save and exit.

- To set/modify the ID of the phone, select '**2.ID**'. The following screen is displayed.

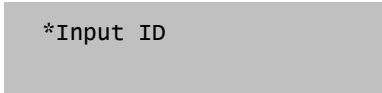

\*Input ID

Enter the ID as a maximum of 16 digits/characters.

- To set/modify the password of the phone, select '**3.Password**'. The following screen is displayed.

Enter the password as a maximum of 8 digits (displays as '\*').

## Verifying Settings and Rebooting

The top level menu '1.Information' allows you to view and verify all your parameter settings.

- When you are satisfied that the settings are valid, select the menu '**6.Exit**' to save all settings and reboot your phone.

## Chapter 3 Things You Should Know

The ITP- and DS-5000D Series of phones comprise the ITP/DS-5021D and ITP/DS-5014D phones. These are 2-line LCD phones that can be used with the Samsung Enterprise IP Solutions OfficeServ System. They are described in detail in this chapter.

ITP and DS phones are operated in the same way. However, IP phones enjoy the added benefits of Internet technology to make and receive calls.

### Front Panel of Phone

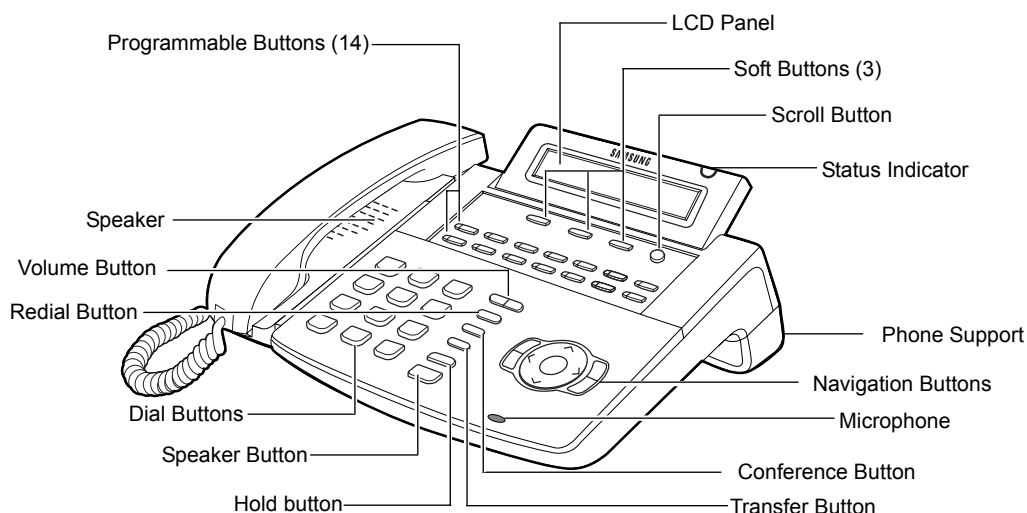

**Figure 3.1 Front Panel of the ITP- and DS-5014D Phone**

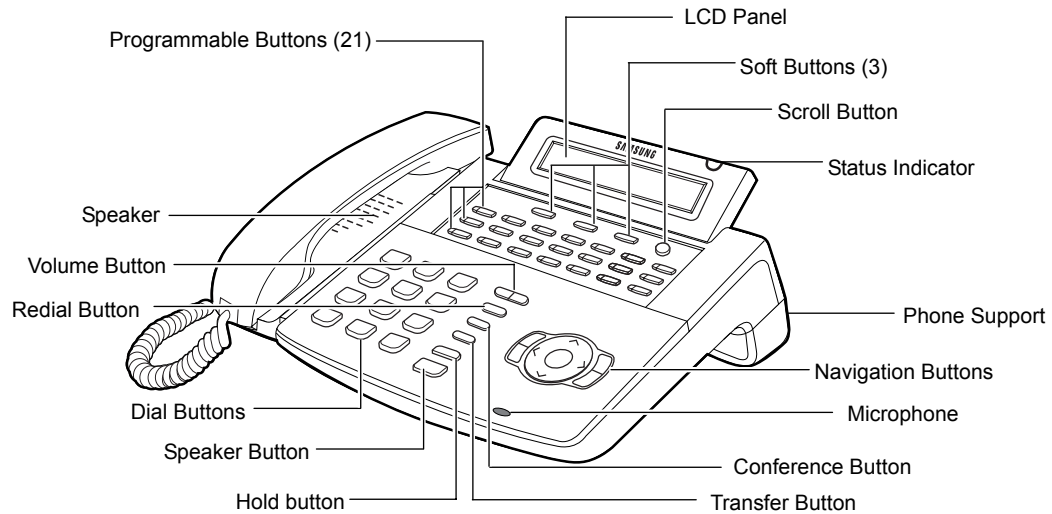

**Figure 3.2 Front Panel of the ITP- and DS-5021D Phone**

- The 14 or 21 programmable buttons can be programmed with desired functions.
- Dial keypad buttons for dialling numbers.
- Volume buttons to control volume levels for handset, speaker, ring etc.
- Redial button redials the last number dialled from the dial keypad.
- Conference button used for conference calls (a number of phones connected simultaneously).
- Transfer button transfers current call to another phone.
- Hold button puts your calls on hold.
- Speaker button turns the speakerphone on/off.
- Navigation buttons guide you easily through phone functions.
- The LCD panel shows call status, functions and other useful information.

- The status indicator displays the status of the phone using red, green, and amber colours.

## **Dial (Keypad) Buttons**

The dial buttons are used to dial digits [0]-[9], [\*] and [#].

## **Programmable Buttons**

ITP- and DS-5021D have 21 programmable buttons; ITP- and DS-5014D have 14 programmable buttons. You can program these buttons with frequently used functions, such as dialling a specific telephone number when pressed. Your system administrator will normally do this for you using system programming (MMCs). Programmable functions are described in **Chapter 4**. Ask the system administrator how your phone is set up if you're not sure.

Buttons are assigned a number from 1 to 21 (or 1 to 14) beginning with the top row left-hand button and ending with the bottom row right-hand button. Each button also has an LED which can display one of three colours, red, amber or green, if the button is being used. (See **Chapter 4** for a description of possible LED displays.)

Three buttons are pre-set to perform the following functions. They may be changed in programming but it is not recommended.

### **Message Button:**

If a message waiting indication is left for you, this button's LED flashes.

### **Call 1 and Call 2 Buttons:**

These are essential in order to allow your phone to make and receive calls. Up to six Call buttons can be set on your phone. Your phone should have at least one Call key, but two are recommended. While the hold or conference functions are in use, the corresponding button's LED flashes.

## **Volume Buttons [ ^ and ▼ ]**

The Volume buttons are used to control the volume levels for the handset, speakerphone, ringing bell and background music. The [ ▼ ] button decreases the volume and the [ ^ ] button increases the volume.

They are also used to move between menus and features on the LCD panel. Press the [ ▼ ] button to move to the previous menu or feature, and the [ ^ ] button to move to the next menu or feature.

## **Redial Button**

The most recent phone number you dialled is held in memory. Press the Redial button to redial the number.

## **Conference Button**

This button can set up a conference call for up to five people, including you.

## **Transfer Button**

This has two main functions:

- Transfers a call at your phone to another extension (and toggles between the other extension and the external caller).
- Enters programming (MMC) mode.

## **Hold Button**

The Hold button is used to temporarily put your current call on hold (without hanging-up) while you do something else, such as dial another number for consultation.

## **Speaker Button**

This is used to make a call through the speakerphone rather than the handset. To change from the handset to the speakerphone while on a call, press the [Speaker] button and put the handset down.

---

## **Navigation Buttons**

These are used to “navigate” through menus and features displayed on the LCD.

### ***Menu Button***

This button is used to display menus of information, such as outgoing and incoming call logs, speed dial numbers, and directory dial numbers. It also allows you to set and display features such as call forwarding and alarm reminder types.

### ***Send Button***

This button is used to answer calls through the speakerphone. If pressed when the phone is idle, the button displays the most recent received number or recent called number saved in memory. If pressed and held down, the last called outside number is redialled.

### ***End Button***

This button terminates the current call or exits the menu mode display (see **Menu Button**).

### ***Cancel Button***

This button is used:

- When moving to the previous step in the menu mode display.
- To cancel the last character/digit while entering data in the display.

### ***Enter Button***

This button is used when selecting or saving a corresponding entry on the menu mode display. It can also be used as the [NND (Name/Number Display)] button when receiving calls. The [NND] button displays ‘caller number’, ‘caller name’, and ‘received time’ in turn, as you press the button, for outside calls (if caller ID information is available).



### *Arrow Buttons*

The left [ $\leftarrow$ ] and right [ $\rightarrow$ ] arrow buttons are used to move the cursor left and right on the LCD panel for editing contents. The up [ $\wedge$ ] and down [ $\vee$ ] arrow buttons are used to move up and down through menus.

### **LCD Panel**

Up to 48 alphabetic characters and numbers can be displayed on the LCD panel on two 24-character lines. The panel shows the processing status and progress of calls, and displays various functions and menus. Below the panel are three soft buttons and a Scroll button.

### **Scroll Button**

This button is used to scroll through menu options on the LCD panel. The menu options displayed depend on the status of the phone (e.g. whether it is idle or busy on a call).

For example, if the button is pressed while the phone is idle, the following menu options are shown:

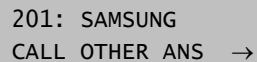

```
201: SAMSUNG
CALL OTHER ANS →
```

A menu option may be selected using the appropriate soft button below it (see **Soft Buttons**, below).

If the arrow symbol ( $\rightarrow$ ) displays, this indicates that other menu options are available. Press the Scroll button to display the new options. Whenever the Scroll button is pressed, different menu options appear on the LCD panel.

### **Soft Buttons**

Soft buttons are used to select the desired menu option from the LCD panel display (see **Scroll Button**).

For example, when selecting the CALL menu, use the left soft button; when selecting the OTHER menu, use the centre soft button; and when selecting the ANS menu, press the right soft button.

## **Microphone**

The small opening below the Navigation buttons is a microphone. You can speak through the microphone without lifting the handset when making a call. To do this, press the [Speaker] button.

## **Phone Status Indicator**

The phone status indicator is located on the upper right-hand edge of the LCD panel. The indicator lights red, green or amber to show the phone's status. See **Chapter 4** for more details.

## Chapter 4 Basic Features

This chapter describes the basic features of the ITP- and DS-5000D Series phones. It is recommended that you familiarise yourself with these features before using your phone so that operating it will be easier and problem free. If you haven't already done so, take time to read **Chapter 3** which explains the functions of the various buttons on your phone.

### Button LEDs

The programmable buttons, [Transfer] button, [Hold] button, and [Speaker] button have LEDs that light red, green or amber when it is being used. The following table summarises the functions of LEDs.

**Table 4.1 Button LED Status**

Function	Button LED Status
Central office line or function is in use	LED is steady green.
New incoming call is ringing	LED is a fast flashing green
A call is on hold	LED is a slow flashing green or red
A held or transferred call is recalling to the phone	LED is a slow flashing amber

### Phone Status Indicator

The status indicator is located on the upper right section of the LCD panel. It shows the status of the phone as described in the table.

**Table 4.2 Status Indicator**

<b>Status of Phone</b>	<b>Status Indicator</b>
Busy on call / Off-hook	Steady red
Internal extension ring	Flashing red
External (C.O.) line ring	Flashing green
Transferred / held call recalling	Flashing amber
Message waiting	Flashing red
Calling denied	Fast flashing red

## Using Feature Codes

System features are programmed with default codes that you can dial to access the features. These are described in the relevant parts of the guide. However, these codes may have been changed in programming; if so, you may find that a feature does not work as described. In such cases, refer to your system administrator for the correct codes (or ask them to check with the installation technician if they don't know what they are).

Default system feature codes are listed in the **Appendix**.

## Selecting Programmed Functions

The most convenient way to select functions on your phone is to have them registered on the programmable buttons, so that you simply press the required button. If a function is not programmed on a button, it can be selected on the LCD panel using the Scroll button and soft buttons. The use of the Scroll button and soft buttons is described in **Chapter 3**.

An advantage of using the soft buttons for functions is that the programmable buttons can be used to assign more buttons for direct extension selection and speed dialling.

## Assigning Button Values (Extenders)

You can add an “extender” to some programmed buttons to make their functions more specific. For example, you could add the extender “4” to the [PAGE] button. Normally, when you press the [PAGE] button, you are asked to enter the page zone to page. With the new extender, pressing the button will automatically page zone 4. The following table lists the extenders that can be assigned to programmable buttons.

**Table 4.3 Extenders Assignable for Programmable Buttons**

Button	Description	Extender
AB	Absence	Extension number
ACC	Account	000-999
BOSS	Director/Secretary	1-4
DIR	Directory	1 (PERS), 2 (SYS), 3 (STN)
DP	Direct Call Pick-up	Extension or extension group number
DS	Direct Extension Select	Station number
FWRD	Call Forwarding	0 = FWD Cancel, 1 = FWD All, 2 = FWD Busy, 3 = FWD No Answer, 4 FWD Busy/No Answer, 5 = FWD DND and-6 = Follow Me
GPIK	Group Call Pick-up	01-20
IG	In / Out Of Group	Extension group number 5xx(x)
MMPG	Meet Me Page	0-9, *
PMSG	Programmed Message	01-20
PAGE	Paging	0-9, *
PARK	Park orbit	0-9
RP	Ring Plan	1-6
SG	Extension Group Selection	Extension group number 5xx(x)
SP	UCD Supervise	UCD group number
SPD	Speed Dial	00-49, 500-999
VT	Voice Mailbox	Voice Mailbox Group (5xx)

## How to Add Extenders

1. Press the [Transfer] button.
2. Press [1][0][7].
3. Select the button for adding the extender.  
Use the [▼ Volume ▲] buttons to scroll through the display of programmable buttons and press the right soft button to select the button (OR you can press the programmable button or enter the number if you know it)
4. Enter the extender using the dial buttons.
5. Save the new key value by pressing the [Transfer] button.

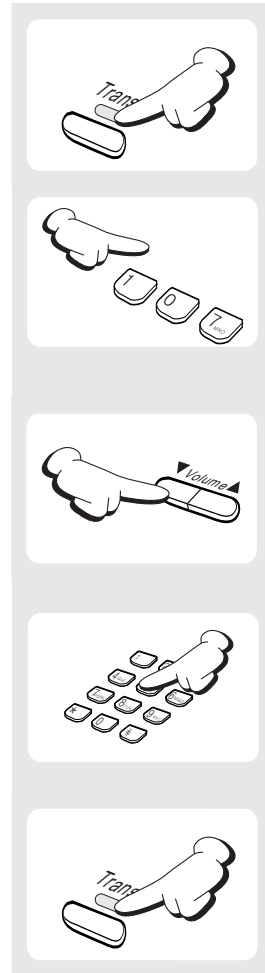

## Controlling Volume Levels

Volume levels for the speakerphone, ringer and handset can be adjusted using the [▼ Volume ▲] buttons. The levels you set will be saved in memory. If background music is set, the volume levels of music and page announcements can also be adjusted using the [▼ Volume ▲] buttons. There are 16 volume levels.

Note: The Volume of off-hook ringing can only be adjusted in programming.

## Handset Volume

1. Pick up the handset and listen to the tone.
2. To increase handset volume, press the [Volume ▲] button.
3. To decrease handset volume, press the [▼ Volume] button.

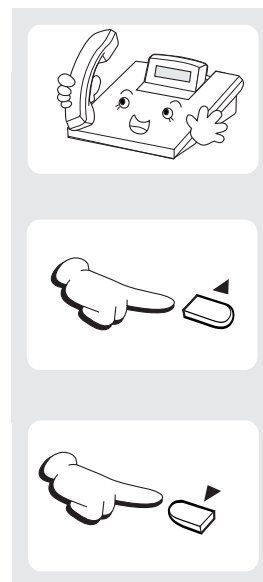

## Speakerphone Volume

1. Press the [Speaker] button.
2. To increase speakerphone volume, press the [Volume ▲] button.
3. To decrease speakerphone volume, press the [▼ Volume] button.

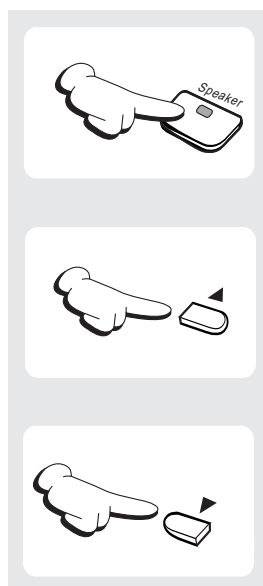

## Ringer Volume

1. To increase ringer volume, press the [Volume ▲] button while the phone is ringing.
2. To decrease ringer volume, press the [▼ Volume] button while the phone is ringing.

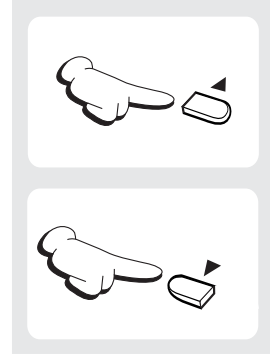

## Selecting the Ring Tone

One of eight ring tones can be selected.

1. Press the [Transfer] button.
2. Press [1][1][1].
3. Press button [1]-[8] in order, or press the [▼ Volume ▲] button, to listen to each ring tone.
4. When you hear the desired dial tone, press the [Transfer] button to save the setting.

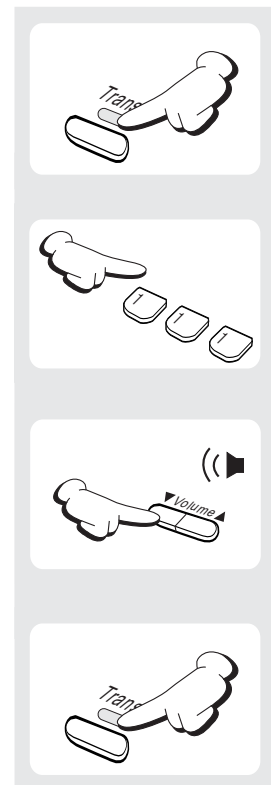



## Changing the Phone Passcode

Your pre-assigned extension passcode is 1234. You can change the passcode if needed.

1. Press the [Transfer] button.

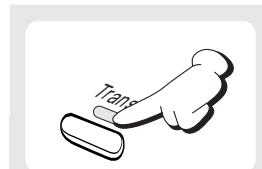

2. Press [1][0][1].

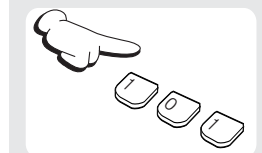

3. Enter the current passcode (e.g. 1234).

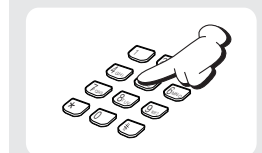

4. Enter the new passcode. The passcode must be a 4-digit number (0-9).

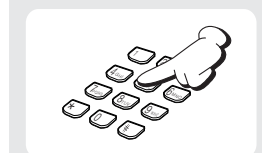

5. Reenter the new passcode for confirmation. If the passcode is entered correctly, a beep will be heard twice. If four beeps are heard, the passcode entry is incorrect.



Reenter the new passcode.

6. Save the new passcode by pressing the [Transfer] button.

## Setting the Answering Mode for Intercom Calls

Intercom calls can be answered in one of three modes. You can select whichever mode suits your working preferences:

**RING MODE:** The phone rings and you answer using either the handset or the speakerphone. This is the normal answering mode.

**AUTO ANSWER MODE:** The phone gives a brief tone and automatically answers the call. The speakerphone is switched on. (Lift the handset for privacy if you prefer.)

**VOICE ANNOUNCE MODE:** The phone gives a brief tone and the caller makes an announcement. Answer the call by pressing the [Send] button (for the speakerphone) or using the handset.

If your phone is set as a “Secretary” or “Executive” extension using a hotline, you also need to tell the system whether the answering mode is for executive answering rather than normal answering (EXEC ANS or ANS MODE).



NOTE

If you set voice announce mode on your phone and also set the Call Forwarding on No Answer function, you must ensure that you press the [Send] button to answer a call before the 'no answer' timer expires. Otherwise, the call will be forwarded.

1. Press the [Transfer] button.
2. Press [1][0][3].
3. Select ANS MODE or EXEC ANS using the [▼ Volume▲] buttons.
4. Move the cursor by pressing the right soft button.
5. Press [0] (Ring mode), or [1] (Auto Answer mode), or [2] (Voice Announce mode)  
OR  
Select the mode using the [▼ Volume▲] buttons.
6. Press the [Transfer] button to save the setting.

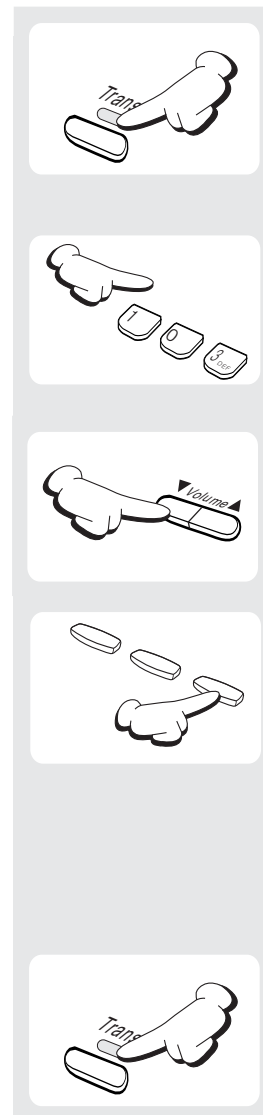

## Switching Headset/Handset Mode

You can switch between handset mode and headset mode if you have a headset connected to your phone. In headset mode, you answer or end a call by pressing the [Send] or [End] button.

1. Press the [Transfer] button.
2. Press [1][1][0].
3. To use the handset, press [0][2][0]  
To use the headset, press [0][2][1]
4. Save the selected entry by pressing the [Transfer] button.

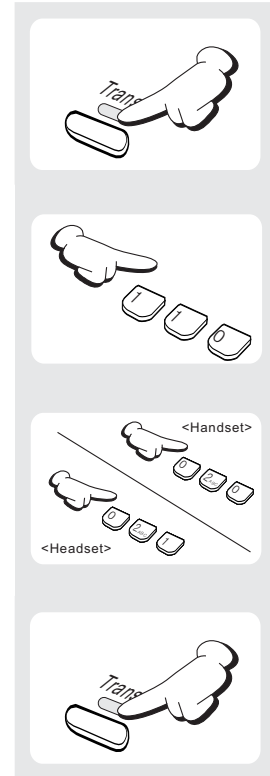

If your phone has a headset mode on/off button, press this button. The button's LED will light when headset mode is set. Press again to return to handset mode. The LED goes off.

## Enabling/Disabling Key Confirmation Tone

When you press a dial button, you may hear a short confirmation tone, depending on whether this feature is enabled or disabled.

1. Press the [Transfer] button.
2. Press [1][1][0].
3. To enable the key confirmation tone, press [0][4][1]; to disable, press [0][4][0].
4. Save the selected entry by pressing the [Transfer] button.

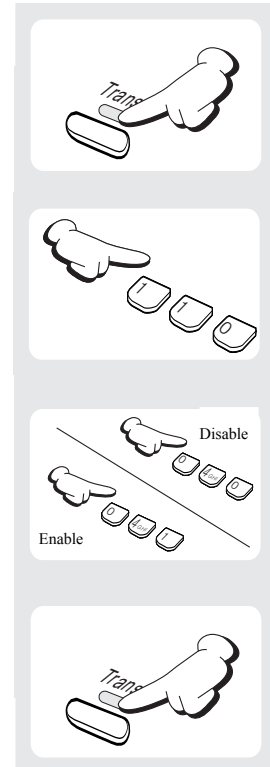

## Hot Keypad

The hot keypad feature allows you to make a call or activate feature codes by pressing the dial buttons directly, without having to pick up the handset or press the [Speaker] button.

To turn this feature on or off:

1. Press the [Transfer] button.
2. Press [1][1][0].
3. To enable the hot keypad, press [0][3][1]; to disable press [0][3][0].
4. Save the selected entry by pressing the [Transfer] button.

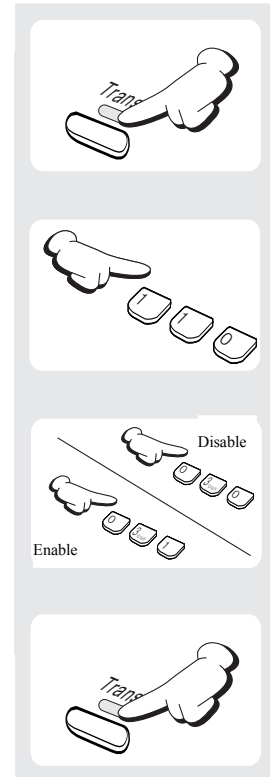

While using a hot keypad, the [Speaker] button LED lights when you dial a number and the speakerphone is enabled. Lift the handset when the call is answered if you want a private conversation.

## Dialling by Directory Name

The online directory of names allows you to find any extension or speed dial number very quickly. Normally, every extension number or speed dial number in the system has a directory name assigned to it (for example, John Smith on extension 201, or Ann Jones on 203). You can select an extension number or speed dial number using the list of directory names by scrolling through the list, which displays in alphabetical order.

1. Press the programmed [DIR] button, or use the Scroll button and soft buttons to select the DIR option in the CALL menu on the LCD panel.
2. Press the soft button to select the directory you wish to use: PERS (Personal), SYS (System) or STN (Extension)  
OR  
Press [1] (PERS), or [2] (SYS), or [3] (STN)
3. Press the dial button that matches the first letter of the name that you wish to find (e.g. J for John).
4. Find the name by using the [▼ Volume ▲] buttons to scroll through the list.
5. To dial the number, press the soft button corresponding to the DIAL option in the LCD panel.

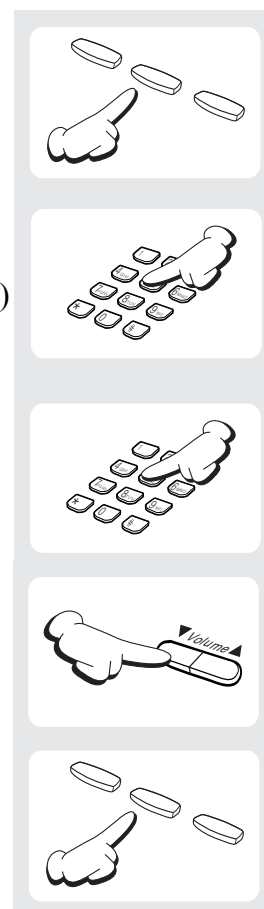



If you program a [DIR] button, you can add the extender 1, 2 or 3, e.g. DIR2, to go straight to the directory you most often use (PERS, SYS or STN).

## Assigning/Changing Your Extension Name

Up to 11 alphabetic characters can be assigned as a name to your phone. The name is entered in the online directory to enable others to call you using the 'dialling by directory name' feature (see above). The name also displays in your LCD panel and in the LCD panels of phones you call.

1. Press the [Transfer] button.
2. Press [1][0][4].
3. Enter the name. (Refer to the Appendix in this guide for the procedure for entering characters.)
4. Save the name by pressing the [Transfer] button.

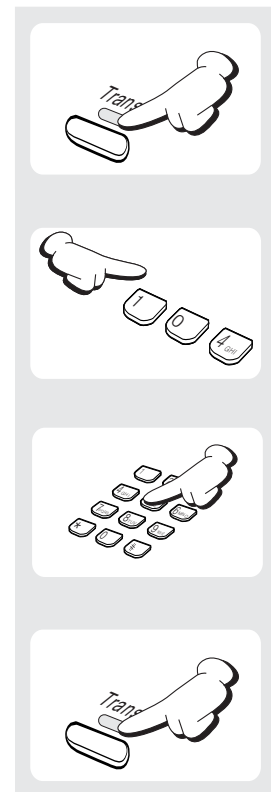



## Making Intercom Calls

### Calling an Extension Number

1. Pick up the handset and listen for dial tone or press the [Speaker] button.  
(Remember: you don't need to do this if the hot keypad feature is switched on.)
2. Dial the extension number (or group number to which the extension belongs).
3. Wait until the called party answers. If you hear a short signal tone (not a ringing tone), the called extension has set up the Voice Announce or Automatic Answer function and you are connected automatically.
4. To finish the call, replace the handset or press the [Speaker] or [End] button.

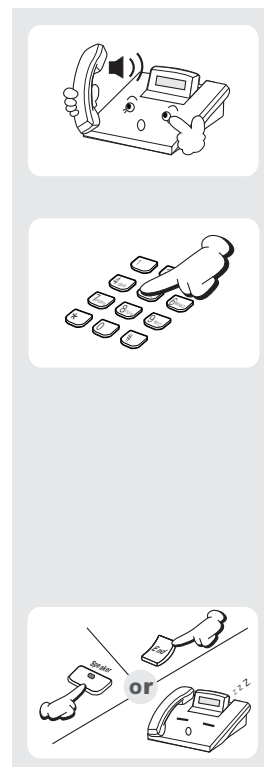

NOTE

If there is a [DS] button assigned to the extension, press this button instead of dialling the number.

## Busy Extension Callback

If a called extension is busy, you can set a busy extension callback. When the busy extension becomes free, your phone will ring. When you pick up the handset, the other extension will ring for the user to answer your call.

1. When you hear a busy signal, press the programmed [CBK] button, or dial [4][4] or press the soft button corresponding to the CBK option on the LCD panel.
2. When you hear the confirmation tone, replace the handset.
3. When the called extension becomes free, your phone rings. The 'CALL BACK' message will appear on the LCD panel.

Lift the handset to ring the free extension and wait for it to answer.

4. To end the call, replace the handset or press either the [Speaker] or [End] button.



NOTE

If you don't answer a callback within 30 seconds, it will be cancelled.

You can have a maximum of five callbacks set on extensions at any one time.

## Busy Extension Camp-On

If a called extension is busy and you don't want to wait for a callback, you can give the called extension off-hook ring tone and wait for them to answer.

Press the [CAMP] button or dial [4][5] or press the soft button corresponding to the CAMP option on the LCD panel.

The called extension will receive off-hook ring tone repeated every few seconds and its first available Call button will flash to indicate your call is waiting.

The extension must release its first call or place it on hold before answering your camp-on.

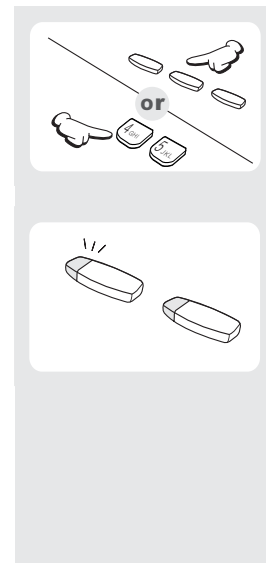

## Calling Your System Operator

Dial [0] to call your system operator or group operator. If you want to call a specific operator, dial that person's extension number.

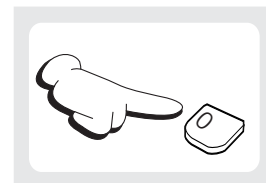

## Answering Intercom Calls

### Answering Intercom Calls in Ring Mode

1. When the phone rings, pick up the handset or press the [Send] button.

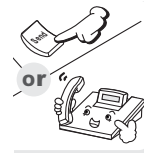

2. To end the call, replace the handset or press the [Speaker] or [End] button

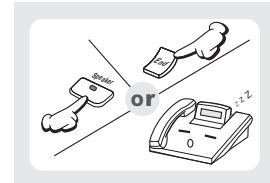

### Answering Intercom Calls in Voice Announce Mode

The phone issues a brief tone and you hear the caller's message.

1. Pick up the handset or press the [Send] button to use the speakerphone.
2. To end the call, replace the handset or press either the [End] or [Speaker] button.

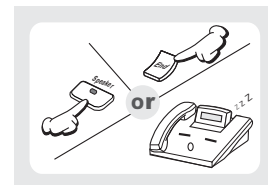
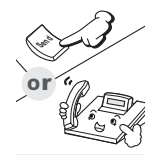

## Answering Intercom Calls in Automatic Answer Mode

The phone issues a brief tone and automatically answers the call.

1. Use the speakerphone to talk.

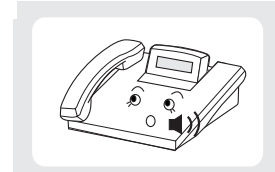

For a private conversation, use the handset.

2. To end the call, replace the handset or press either the [End] or [Speaker] button.

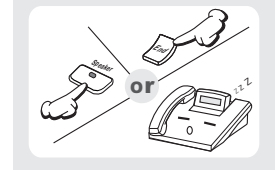
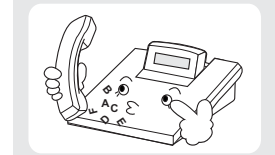

## Making Outside (External) Calls

### Calling Outside Lines—an Overview

Outside calls are made via central office (C.O.) lines. To call an outside number you first need to press a programmed line button or line group button or dial the C.O. line access code ('9' for example). If you have an LCR button (for least cost routing) you should press that. Ask your system administrator what is set up for your phone.

You may also be asked to enter an account and/or authorisation code in order to be able to make a call (or you may choose to enter a code voluntarily). These are described next.



NOTE

If you try to make a call if there are no available Call buttons, you will hear No More Calls tone instead of ringing tone and you cannot complete the call.

### Authorisation Codes and Account Codes

Account codes ensure your call is charged to the proper account or department. Authorisation codes ensure you are authorised to make outside calls. You may be required to enter a code before a call can be made (these are referred to as “forced” codes), or you may voluntarily enter a code before or during a call.

#### Entering Account Codes

If you are asked to enter an account code when you select an outside line, press the programmed [ACC] button or the soft button for the ACCT option on the LCD panel. Enter the code using the dial keys. To voluntarily enter a code before making a call or during a call, press the [ACC] button or dial [4] [7] and enter a valid code, press the [ACCT] button again.

## Entering Authorisation Codes

If you are asked to enter an authorisation code when you select an outside line, press the programmed [AUTH] button or the soft button for the AUTH option on the LCD panel. Enter the code using the dial keys. To voluntarily enter a code before making a call, press the [AUTH] button or the [#] button and enter a valid code.



NOTE

Ask the system administrator for more information on authorisation and account codes.

## Calling Outside Lines Using the Handset

1. Pick up the handset.
2. Press the outside line access button or dial the access code (e.g., 9).  
  
(Enter an account or authorisation code if requested.)
3. Dial the outside number you want to call.
4. To end your call, replace the handset.

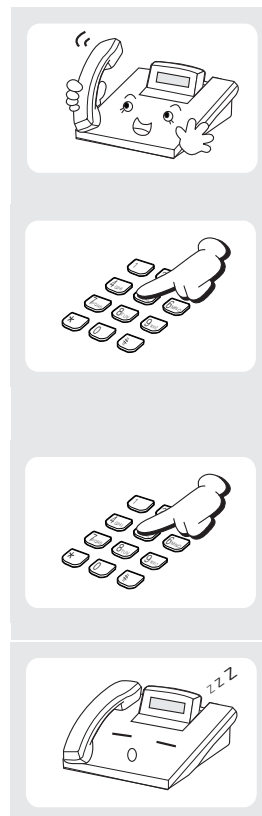

## Calling Outside Lines Using the Speakerphone

1. Press the [Speaker] button.  
(Remember: you don't need to do this if the hot keypad feature is switched on.)

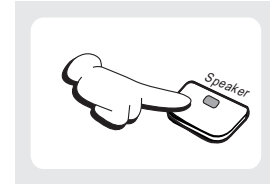

2. Press the outside line access button or dial the access code (e.g., 9).

(Enter an account or authorisation code if requested.)

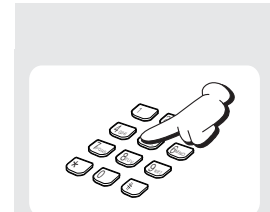

3. Dial the outside number you want to call.

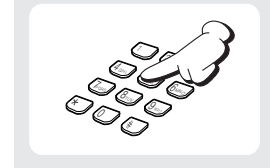

4. To end your call, press the [Speaker] button.

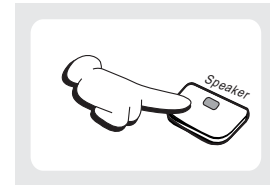

## Making a New Call Without Releasing the Line (Recall Dial Tone)

It is possible to complete your current call and make a new call without hanging up the phone. Press the programmed [NEW] button to disconnect your existing call, wait for dial tone and then make a new call on the same line. If this [NEW] button does not appear on your phone, press the soft button corresponding to the NEW option on the LCD panel.



## Busy Line Queuing With Callback

If there is no available C.O. line to make your call, you can set a callback to reserve a line. When a line becomes free, your phone will ring.

1. If you receive a busy tone when you select a C.O. line, press the programmed [CBK] button or dial [4][4].  
Or, press the soft button corresponding to the CBK option on the LCD panel.
2. When confirmation tone is heard, replace the handset.
3. When the line becomes free, the system will call you back.
4. Lift the handset or press the [Send] button, wait for dial tone and dial the number you require.

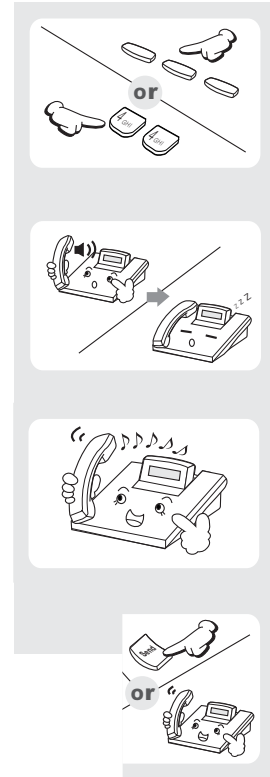

If you don't answer a callback within 30 seconds, it will be cancelled.

You can have a maximum of five callbacks set on C.O. lines at any one time.

## Cancelling a Callback

1. Press the [CBK] button or dial [4][4]. You will hear confirmation tone.
2. Press the [Hold] button. This will cancel the oldest callback you have set. Do this for each callback you wish to cancel.

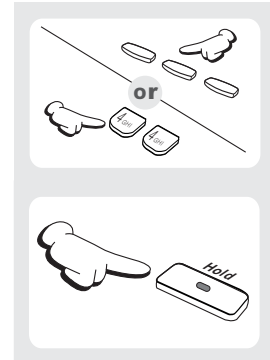

## Answering Outside Calls

For an incoming outside call, lift the handset or press the [Send] button to answer on the speakerphone.

(Also refer to **Ring Preference** in Chapter 10.)



NOTE

If a call is flashing on a button but not ringing, you must press the flashing button to answer the call.

### Universal Answer

If a call is ringing in the Night mode, it may be programmed to ring through an external speaker. In this case, press [6][7] or the programmed [UA] button to answer the call.

### Holding a Call

There may be occasions when you need to temporarily interrupt your current call and keep the other party on hold (for example, to get more information or to answer an important incoming second call). The types of hold function available are:

System hold	Puts the current call on hold. Other phone users can take it off hold.
Exclusive hold	Puts the current call on hold. Other phone users cannot take it off hold.
Automatic hold	Puts the current call on hold and automatically connects you to the new incoming call. Automatic hold is a feature that must be programmed for your phone.
Consultation hold	Puts the current call on hold and allows you to consult with another phone user.

## System Hold

1. While on a call, press the [Hold] button.

The call on hold will flash green on a Call button on your phone, and will flash red on the line button on other phones. (Another user can press the flashing red button to take the call off hold if necessary. See **Retrieving Calls Held at Another Extension**, below.)

2. To take the call off hold, press the flashing Call button.
3. Resume your conversation.

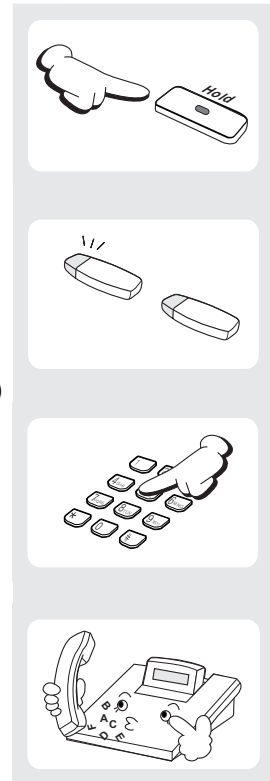

## Automatic Hold

If a second call arrives while you are busy on an outside call, it will flash at a Call button on your phone. If the Auto Hold feature is enabled at your phone (see below), pressing the flashing button will automatically put your current call on hold and connect you to the new call.

**To enable the Auto Hold feature:**

1. Press the [Transfer] button.
2. Dial [1][1][0].
3. Dial [0][0][1] to enable, or [0][0][0] to disable, the Auto Hold feature.
4. Press the [Transfer] button to save the setting.

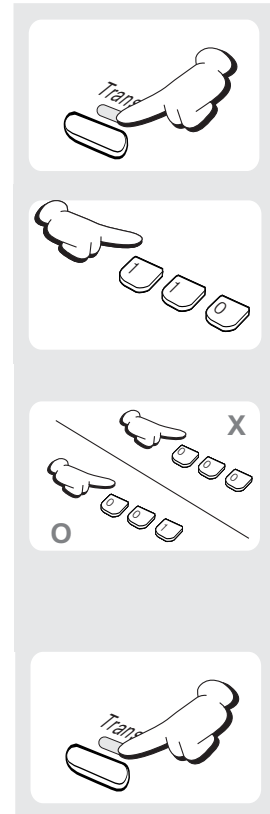

NOTE

You cannot use this feature for holding intercom calls. Intercom calls will be disconnected.

## Exclusive Hold

To place an outside call on hold so that other users cannot access it :

1. Press the [Hold] button twice.
2. The call will flash green on a Call button on your phone and will show a steady red light on other phones.
3. To retrieve the call on hold, press the flashing green button or press the [Hold] button three times.

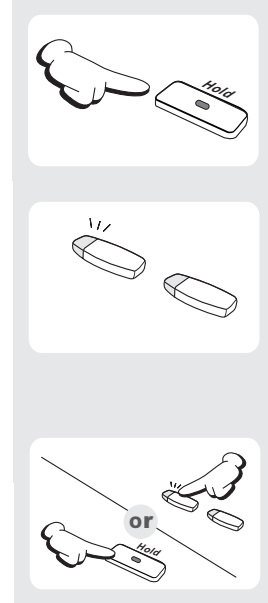

Intercom calls will always be set on exclusive hold.

## Consultation Hold

You can place an outside call on hold and make a call to another extension for consultation.

1. Press the [Transfer] button; you will hear transfer dial tone. Your call is placed on transfer hold.
2. Dial the extension number.
3. Consult with the internal party. The outside party cannot hear your conversation.
4. Press the [Transfer] button to return to the outside party.

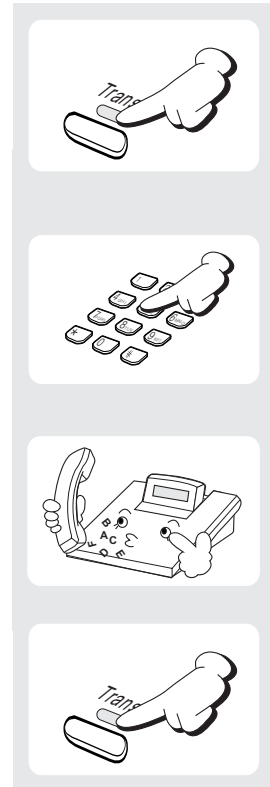

NOTE

Repeatedly pressing the [Transfer] button will toggle between the outside party and internal extension. Neither party can hear your conversation with the other.

## **Hold Recall**

If you leave a call on hold longer than the hold timer set in the system, it will recall your phone. The Call button will show a slow flashing amber light. If you do not answer the recall within a set time, it will go to the system operator.

Lift the handset or press the [Send] button to answer the recall.

## **Retrieving Calls Held at Another Extension**

When a call is on hold at another extension, the appropriate line button on your phone (if it is programmed) will have a flashing red light. To retrieve the call on hold, press the line button.

When a call is on hold at another extension but you do not have a line key, dial [1][2] followed by the line number or the extension number of the extension that placed the call on hold.



## Parking Calls

You can park an outside call in one of 10 “parking orbits” (0-9) to be picked up by another user.

1. Press the programmed [PARK] button.  
Or, press the soft button corresponding to the PARK option on the LCD panel.  
(If you press a dedicated [PARK] button with an extender for a parking orbit, skip step 2.)
2. Press the orbit number required, [0]-[9]  
(the [PARK] button will flash.)
3. To have the parked call picked up by another user,  
notify them of the parking orbit number.

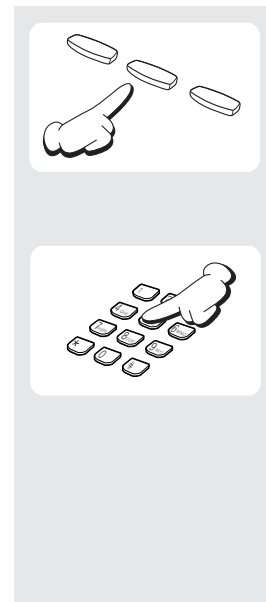

### To Retrieve a Parked Call

To pick up a parked call, press the [PARK] button followed by the required orbit number, or press the flashing [PARK] button.

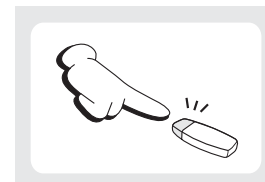

NOTE

Refer also to “**Call Park and Page**” in Chapter 9.

## Transferring Calls

You can quickly and easily transfer your current call to another extension. A ‘blind’ transfer means you don’t announce the call, unlike a ‘screened’ transfer where you do.

1. While on a call, press the [Transfer] button.
2. Dial the extension or group number, or press the programmed [DS] button. Your current call is automatically put on transfer hold. (See Note, below.)
3. For a ‘blind’ transfer, hang up when you hear ringing. For a ‘screened’ transfer, wait for the called party to answer and advise them of the call, then hang up.

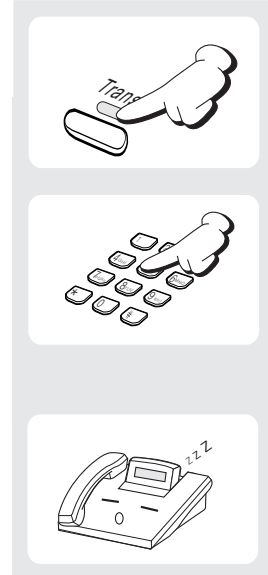

### Reconnecting with the Outside Party

If the transfer is refused and the called extension hangs up, you will be reconnected to the outside line. Alternatively, you can press the [Transfer] button to return to the outside party.

### Transferring to Another Extension

If you wish to send the call to another extension without waiting for the first extension to hang up, simply press another [DS] button. Alternatively, press the Call button or C.O. line button to return to the outside party and begin the transfer process again.



- When the extension answers, you may toggle between the parties by pressing the [Transfer] button. Neither party can hear the other until the transfer is complete.
- If you receive No More Calls tone, the extension has no button available to receive another call or is in Do Not Disturb mode. Press the [Transfer] button to return to the outside party.
- You cannot transfer an intercom call by pressing the [DS] button. Dial the destination extension number.
- When you are transferring a call to a phone set for Voice Announce or Auto Answer, the transferred call will always ring the phone.

### Transfer With Camp-On

When you are transferring a call to another extension and you receive a busy signal, you may “camp on” the call to this extension. The extension will be alerted that a call is waiting (see **Call Waiting**, below).

To camp on when transferring, simply hang up when you hear a busy signal.

### Transfer To Voice Mail

This feature is used to send a call directly to a voice mailbox. Your phone must have a programmed [VT] button to accomplish this.

1. Press the [VT] button while you are on a call. Or, press the soft button corresponding to the [VT] entry on the LCD panel.
2. Dial the mailbox number.
3. Hang up.

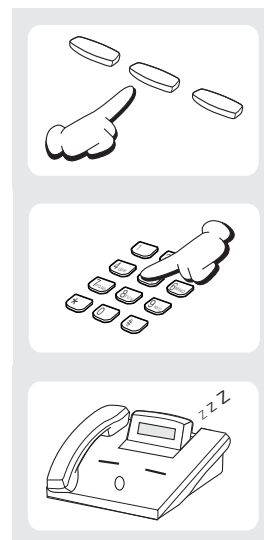

## Call Waiting

If an outside call or other extension has camped-on to you, your phone will ring and the waiting call's button will flash green.

1. Press the flashing button to answer the waiting call.
2. If your phone has the Auto Hold feature set, your current call will go on hold automatically and you are connected to the new call.

If this feature is not set, press the [Hold] button and then press the flashing button to answer the new call.

(Or, finish the current call and hang up. The waiting call will ring. Lift the handset or press the [Send] button to answer the new call.)

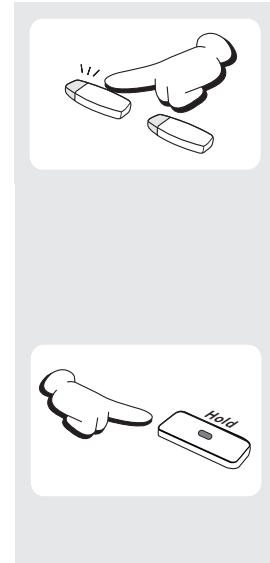

## Chapter 5 Program Menu

ITP- and DS-5000D Series phones are equipped with Navigation buttons for easy use of features and menus. This chapter describes the functions of each Navigation button and the procedures for using the various applications that are implemented by the menu buttons.

### Navigation Buttons

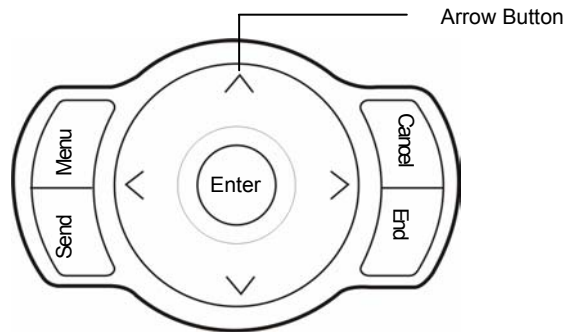

Figure 5.1 Navigation Buttons

#### Menu Button

The [Menu] button displays the main menu (see **Main Menu**, below).

#### Send Button

- If you press [Send] while the phone is idle, you enter the [OUTGOING LOGS] function.
- If you press [Send] in dial mode, you enter the [OUTGOING LOGS] status regardless of the numbers previously pressed.
- If you press [Send] while an incoming call is ringing at your phone, the speakerphone is turned on.
- If you press [Send] while using the [OUTGOING LOGS], [INCOMING LOGS], [SPEED DIAL] or [DIRECTORY DIAL] function to select a number, the selected number will be dialed.

## End Button

This button is used to disconnect calls or to exit the menu mode.

## Cancel Button

The [Cancel] button is used in menu mode to move to the previous menu level. If you press [Cancel] when at the first menu level, you exit menu mode.

[Cancel] is also used to erase numbers or characters you enter on the LCD panel.

## Enter Button

This button is used in menu mode to select or save the item the cursor is indicating. This button may also be used as the [NND] (Name/Number Display) button when receiving calls.

The [NND] button displays 'caller number', 'caller name', and 'received time' in sequence as you press the button, if caller information is available.

## Direction (Arrow) Buttons

These buttons are used for scrolling through menu items and when editing (such as entering or cancelling contents in the LCD panel).

- [^] button  
Move to the previous menu.
- [v] button  
Move to the next menu.
- [<] button  
If a phone number too long for the LCD panel is displayed, move left to display beginning digits not showing on the LCD.
- [>] button  
If a phone number too long for the LCD panel is displayed, move right to display following digits not showing on the LCD.

## Main Menu

- Press the [Menu] button to see the main menu:

```
SELECT MENU
1. OUTGOING LOGS
```

- Press the up and down arrow button to scroll through the options 1-6.

```
2. INCOMING LOGS
3. SPEED DIAL
4. DIRECTORY DIAL
5. FORWARD SET
6. ALARM REMINDER
```



Calls are not interrupted if the [Menu] button is pressed while you talking. If you press the [End] button, you will automatically exit from the menu mode.

## How to Select Menu Items

- Use the [^]/[v] direction buttons or the [▼ Volume ▲] buttons to move to the item or press the dial button corresponding to the item (e.g. 3 for Speed Dial).
- Press the [Enter] button to select the item.
- Press the [End] button to exit menu mode.
- If you press any button other than the Navigation buttons, you will exit menu mode.



If someone calls you while you are in menu mode, they will hear busy tone.

## Viewing and Redialling Recently Called Numbers

Up to 50 of your most recently called numbers can be saved in the system's memory (your system administrator can tell you what number is set). You can view these numbers and call them again using the menu.

1. Press the [Menu] button to display the main menu.
2. Select [1.OUTGOING LOGS].
3. The list of recently called numbers is displayed. You can verify each number on the list in turn using the [^]/[v] buttons or the [▼ Volume▲] buttons. Use the [<]/[>] buttons to view long numbers that do not fully appear on the LCD.
4. To redial a number, move to the number you require and press the [Send] button.



## Viewing and Calling Recently Received Numbers

Up to 50 of your most recently received numbers can be saved in the system's memory (your system administrator can tell you what number is set). You can view these numbers and call them using the menu..

1. Press the [Menu] button to display the main menu.
2. Select [2.INCOMING LOGS].
3. The list of recently received numbers is displayed. You can verify each number on the list in turn using the [^]/[v] direction buttons or the [▼ Volume▲] buttons. Use the [<]/[>] direction buttons to view long numbers that do not fully appear on the LCD.
4. To dial a number, move to the number you require and press the [Send] button.

## Viewing and Calling Personal Speed Dial Numbers

Using the menu, you can view and call the personal speed dial numbers you have created.

1. Press the [Menu] button to display the main menu.
2. Select [3.SPEED DIAL]. The submenu below is displayed.

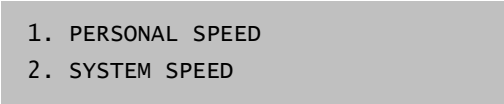

```
1. PERSONAL SPEED
2. SYSTEM SPEED
```

Select [1.PERSONAL SPEED].

3. The saved personal speed dial list appears. You can verify each number on the list in turn using the [^]/[v]direction buttons or [▼ Volume▲] buttons. Use the [<]/[>]direction buttons to view long numbers that do not fully appear on the LCD.

4. To call a speed dial number, move to the number you require and press the [Send] button to make.

## Viewing and Calling System Speed Dial Numbers

You can view and call system speed dial numbers designated by the system administrator.

1. Press the [Menu] button to display the main menu.
2. Select [3.SPEED DIAL]. The submenu below is displayed.

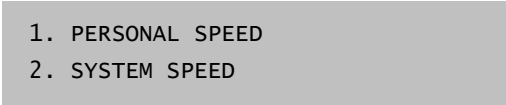

```
1. PERSONAL SPEED
2. SYSTEM SPEED
```

Select [2.SYSTEM SPEED].

3. The system speed dial list appears. You can verify each number on the list in turn using the [^]/[v] direction buttons or [▼ Volume▲] buttons. Use the [<|>] direction buttons to view long numbers that do not fully appear on the LCD.
4. To call a system speed dial number, move to the number you require and press the [Send] button.

## Viewing and Calling Personal Speed Dial Numbers by Name

You can view and call a personal speed dial number using the name associated with it.

1. Press the [Menu] button to display the main menu .
2. Select [4.DIRECTORY DIAL]. The submenu below is displayed.

```
1. PERSONAL SPEED
2. SYSTEM SPEED
3. STATION NUMBER
```

Select [1.PERSONAL SPEED].

3. Use the dial buttons to enter the first letter of the name you want to find (e.g. M for Matthew) and press the [Enter] button.

```
Enter 1st letter
M
```

The first personal speed dial number found for names starting with the entered letter is displayed, e.g.

```
00:MARTIN
9 - 1 2 3 4 5 6 3 2 2 4
```

If there are no names starting with the letter entered, an error message is displayed and you can enter another letter or press [End] to exit menu mode.

4. Scroll through names on the list using the [^]/[v] direction buttons or the [▼ Volume ▲] buttons. Use the [<|>]direction buttons to view long numbers that do not fully appear on the LCD.



Press the [Cancel] button to return to the previous menu.

NOTE

5. To dial a number, scroll to it in the list and press the [Send] button.

## Viewing and Calling System Speed Dial Numbers by Name

You can view and call a system speed dial number using the associated name designated by the system administrator.

1. Press the [Menu] button to display the main menu.
2. Select [4.DIRECTORY DIAL]. The submenu below is displayed.

```
1. PERSONAL SPEED
2. SYSTEM SPEED
3. STATION NUMBER
```

Select [2.SYSTEM SPEED].

3. Use the dial buttons to enter the first letter of the name you want to find (e.g. M for Matthew) and press the [Enter] button.

```
Enter 1st letter
M
```

The first system speed dial number found for names starting with the entered letter is displayed, e.g.



```
00:MARTIN
9-432345662
```

If there are no names starting with the letter entered, an error message is displayed and you can enter another letter or press [End] to exit menu mode.

4. Scroll through numbers on the list using the [^]/[v] direction buttons or [▼ Volume▲] buttons. Use the [<]/[>] direction buttons to view long numbers that do not fully appear on the LCD.
5. To dial a number, scroll to it in the list and press the [Send] button.

## Viewing and Calling Extension Numbers by Name

You can view extensions by name or call an extension directly from the menu.

1. Press the [Menu] button to display the main menu.
2. Select [4. DIRECTORY DIAL]. The submenu below is displayed.

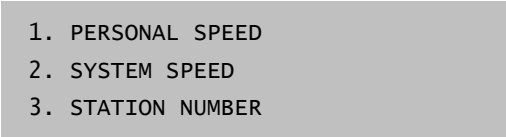

```
1. PERSONAL SPEED
2. SYSTEM SPEED
3. STATION NUMBER
```

Select [3.STATION NUMBER].

3. Use the dial buttons to enter the first letter of the name you want to find (e.g. M for Matthew) and press the [Enter] button.

```
Enter 1st letter  
M
```

The first extension number found for names starting with the entered letter is displayed, e.g.

```
3 6 4 5 : MARTIN
```

If there are no names starting with the letter entered, an error message is displayed and you can enter another letter or press [End] to exit menu mode.

4. Scroll through the numbers on the list using the [^]/[v] direction buttons or [▼ Volume▲] buttons. Use the [ < ]/[ > ] direction buttons to view long numbers that do not fully appear on the LCD.
5. To dial a number, scroll to it in the list and press the [Send] button.

## Setting Call Forward Type and Destination

You can set forwarding options on your phone to send your incoming calls to another phone (or to voice mail if this is set up for you). The Forward Type determines which calls are forwarded: all calls to your phone (ALL); all calls arriving when you are already busy on a call (BUSY); calls not answered within a specific time for any reason (NO ANS); or calls arriving when you have set Do Not Disturb (DND) on your phone.

1. Press the [Menu] button to display the main menu.
2. Select [5.FORWARD SET]. The submenu below is displayed.

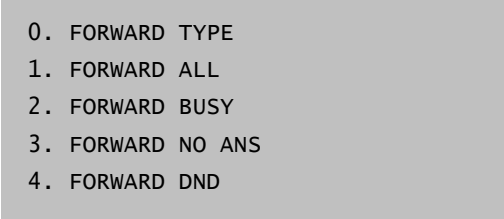
- 
- 0. FORWARD TYPE
  - 1. FORWARD ALL
  - 2. FORWARD BUSY
  - 3. FORWARD NO ANS
  - 4. FORWARD DND

3. Select [0.FORWARD TYPE]. The submenu of the available forward types is displayed.

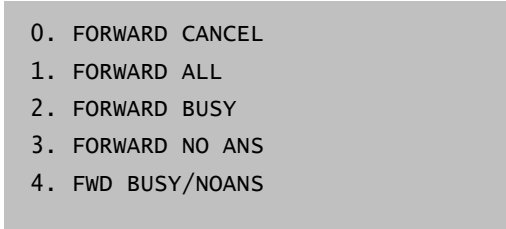
- 
- 0. FORWARD CANCEL
  - 1. FORWARD ALL
  - 2. FORWARD BUSY
  - 3. FORWARD NO ANS
  - 4. FWD BUSY/NOANS

4. Select the intended forward type by using the [^]/[v] direction buttons, the [▼ Volume ▲] buttons, or by pressing the dial button corresponding to the forward type, then press the [Enter] button.
5. The forward type is selected and you move to the upper menu displaying the submenu shown below.

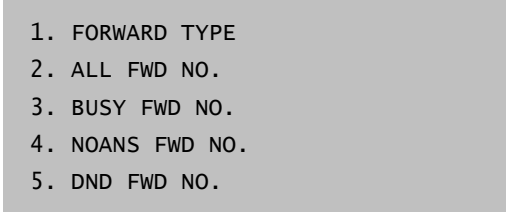
- 
- 1. FORWARD TYPE
  - 2. ALL FWD NO.
  - 3. BUSY FWD NO.
  - 4. NOANS FWD NO.
  - 5. DND FWD NO.

6. Use the [^]/[v] direction button or the [▼ Volume ▲] button, or select the number of the forward type you have selected using the dial button, and press the [Enter] button.
7. Enter the number to be forwarded using the dial buttons. For example, if you selected [1. ALL FORWARD], enter the numbers in the LCD panel as shown below.

```
ALL FWD NO.  
9_1 2 3 4 5 6 7
```

Use the [◀]/[▶] direction button to move the cursor in the number input screen. Use the [Cancel] button to erase all entered numbers and re-enter numbers.

8. Press the [Enter] button to save the number entered and to move to the upper menu.
9. Press the [End] button and end the menu mode.

## Setting Reminder Alarms

You can set the time and type of reminder alarms. When set, you will hear a series of short rings at the set time(s) and “Alarm Reminder” is displayed on the LCD panel. You can set up to three different alarms (1-3) and each can be set to ring TODAY only at the set time or DAILY (every day) at the set time. An alarm can also be set to NOTSET, in which case it does not ring.

1. Press the [Menu] button to display the main menu.
2. Select [6.ALARM REMINDER]. The submenu below is displayed.

```
1. ALARM 1  
2. ALARM 2  
3. ALARM 3
```

3. Use the [^]/[v] direction buttons or the [▼ Volume ▲] buttons, or press the dial button corresponding to the alarm number, and press the [Enter] button.

The submenu for setting the alarm type and time appears.

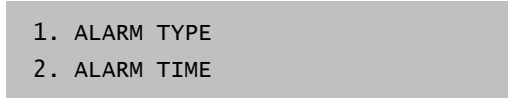

- 
1. ALARM TYPE
  2. ALARM TIME

4. Select [1. ALARM TYPE], and press the [Enter] button.

The submenu for the alarm type is displayed.

- 
0. NOT SET
  1. TODAY
  2. DAILY

5. Use the [^]/[v] direction buttons, or the [▼ Volume ▲] buttons, or the relevant dial button to select the alarm type (e.g. TODAY), and press the [Enter] button. The selected alarm type is saved and you move to the previous menu.

- 
1. ALARM TYPE
  2. ALARM TIME

6. Select [2. ALARM TIME] and press the [Enter] button. The alarm time screen is displayed.



ALARM TIME  
H H : m m

7. Use the dial buttons to enter the alarm time in 24-hour clock format (e.g. 13:30 for 1.30 pm).

Use the [<]/[>] direction buttons to move the cursor on the LCD. Use the [Cancel] button to delete a set time and re-enter it.

8. Press the [Enter] button to save the entered time and to move to the previous menu.
9. Press the [End] button to exit menu mode.

### **To Answer an Alarm**

Answer an alarm by lifting the handset. If you do not answer, the alarm will ring up to four times at short intervals before cancelling.

### **To Cancel an Alarm**

Select the alarm number as described in the procedure above. Then either select the alarm type as NOT SET or set the alarm time to 0000. Then press the [End] button to exit menu mode.

## Chapter 6 Dialling Features

Dialling features comprise:

- Speed dial numbers and names (including one-touch speed dial buttons)
- Chain dialling
- Redialling numbers
- Pulse to Tone dialling changeover
- Conference calls

### Speed Dialling

Your system may already have a system list of speed dial numbers for frequently used phone numbers. You may also assign numbers to a personal speed dial number list. This way you don't have to dial the whole number but simply dial the 2- or 3-digit speed number instead. You can also assign a speed dial number to a programmed [SPD] button for even faster one-touch speed dialling. This is particularly useful for long phone numbers. Names can also be assigned to each speed dial.

#### Buttons "A" to "F"

When programming speed dial numbers, the programmable buttons designated as A, B, C, D, E, and F can be used.

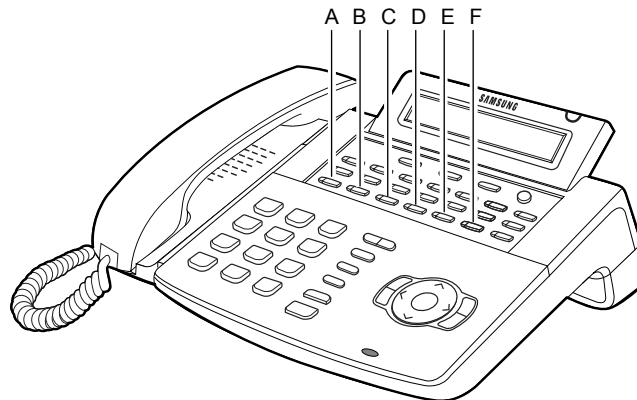

Figure 6.1 Buttons A-F (5021D)

A,B,C,D,E, and F buttons are the first six buttons on the *bottom* line of programmable buttons on both types of phone (ITP-5021D and 5014D).

Button	Description
A	Toggle between uppercase and lowercase characters when entering speed dial names.
B	Insert "FLASH" (F)
C	Insert "PAUSE" (P)
D	Convert from the pulse dialling (mechanical) to tone dialling (electronic). If your system uses pulse dialling C.O. lines, pressing D while entering a speed dial number causes all subsequent digits to be sent as DTMF tones.
E	Insert "[", character to prevent the actual phone number, or some of the digits, from showing on the LCD panel when the speed dial number is used. Any digits entered after the "[" symbol are displayed as "*" only. Pressing E again inserts the "]" character so any digits entered after the "]" character will display on the LCD.  For example: 1234[567890 will display as 1234*****, and 1234[5678]90 will display as 1234****90
F	Input a name for a speed dial number while programming the numbers (F button toggles between number entry and name entry during programming)
Hold	Clear a speed dial number

## Programming Personal Speed Dial Numbers

Your station can be assigned up to fifty speed dial numbers (00-49). Ask the system administrator how many are assigned for you.

To program personal speed dial numbers:

1. Press the [Transfer] button and dial [1][0][5].
2. Dial the speed dial number (00-49), or use the [▼ Volume ▲] buttons to select and press the right soft button.
3. If programming an outside number, enter the outside line access code or line number (e.g. '9', '702', etc). A hyphen ("-") is automatically entered after the number.
4. Enter the phone number to be saved (maximum of 24 digits) (see table above for special characters A-F)  
Tip: To enter a name for this speed dial number, press the F button to go to step 4 of the procedure below.
5. Press the [Transfer] button to save the number.

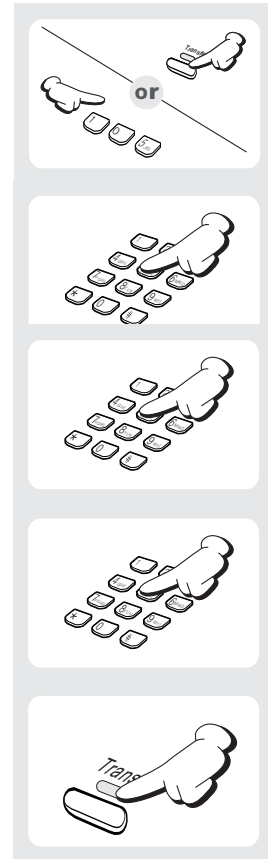

## Assigning a Name to a Speed Dial Number

A name up to 11 characters can be assigned for each speed dial number. This name is used to dial numbers using the Dialling by Directory Name feature (see **Chapter 4**). Names can be assigned while programming speed dial numbers (above) or using a different program, as described here.

1. Press the [Transfer] button.
2. Dial [1][0][6].
3. Enter the speed dial number to be assigned a name (00-49).
4. Enter a name. (Refer to the **Appendix** in this manual for how to enter characters.)  
*Tip: If you used the F button in order to enter a name while programming a speed dial number (see previous procedure), press the F button again to return to step 4 of that procedure.*
5. Press the [Transfer] button to save the speed dial name.

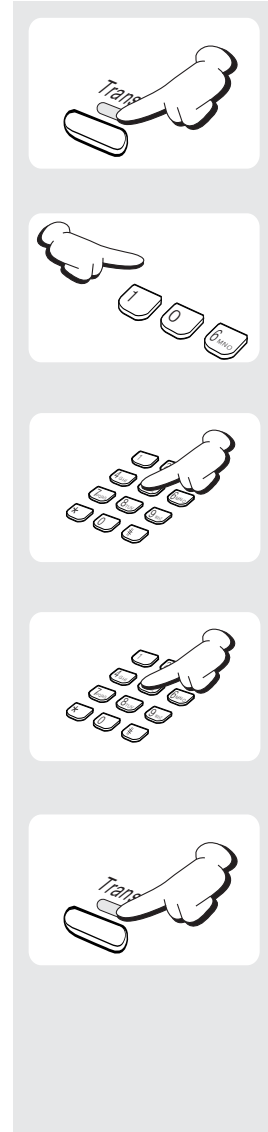

## Dialling Using Speed Dial Numbers

You can dial speed dial numbers from the list of system numbers (500-999) created by the system administrator or from the personal list of numbers (00-49) you have created.

1. Press the programmed [SPD] button or dial [1][6].

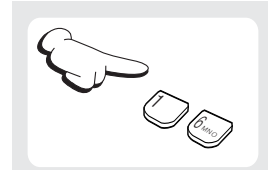

2. Dial the speed dial number programmed for the number you want to call (e.g. 00)



The number is dialled automatically.

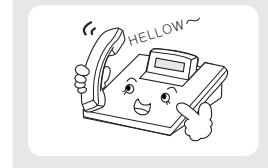

Alternatively, to dial one of your first 10 personal speed dial numbers:

Without lifting the handset, hold down a dial pad button 0–9 corresponding to the speed dial number (00–09) for approximately two seconds. The telephone number programmed in the personal speed dial location will be dialled automatically.

## Programming One-touch Speed Dial Buttons

You can assign frequently used speed dial numbers to one-touch speed dial buttons for even more convenience. To do this, you must have a programmed [SPD] button for each speed dial you require.

1. Press the [Transfer] button.
2. Dial [1][0][7].
3. Press a [SPD] button.
4. Enter the speed dial number (00-49 or 500-999) to be assigned to this button.
5. Press the [Transfer] button to save the selected number.

Now, to make a call to the number, simply press this speed dial button.

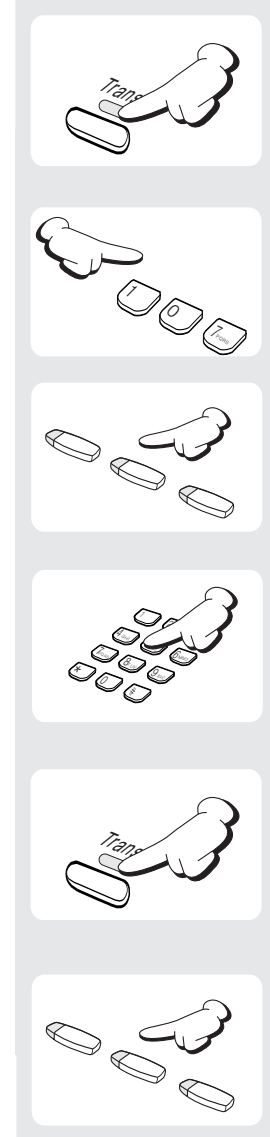



## Chain Dialling

After the speed dial number is pressed, additional number or desired speed dial number can be dialed manually.

After the first speed dial number, press the programmed [SPD] button or dial [1][6] and then dial another speed dial number. Alternatively, after the speed dial number, dial the additional numbers manually.

## Redial an Outside Number

To redial the last outside number you called, press the [Redial] button, or press and hold down the [Send] button, or dial [1][9].



NOTE

Redial does not apply to intercom calls.

## Save Number with Redial

To save the number you just dialled in memory, select the [SAVE] option on the LCD panel before hanging up. (Use the Scroll and relevant soft button to select.)

The saved number can be redialled at any time by selecting the [SNR] option on the LCD panel or dialling [1][7].



NOTE

- The saved number will be kept in memory only until you save another number.
- Redial does not apply to intercom calls.

## Automatic Redial/Retry

When you make an outside call and receive a busy signal, the system can automatically redial the number for you. It will automatically redial at a pre-programmed interval for up to 99 attempts.

1. When you hear a busy signal, press the programmed [RETRY] button or press the soft button corresponding to the [RETRY] option on the LCD panel.
2. The system will reserve the line and automatically redial the same number for you. You will hear the call being made through the speaker. The microphone is muted.
3. When the called party answers, pick up the handset or press the [Speaker] or [Send] button before you begin speaking. You must answer within 10 seconds.



NOTE

- If you make another call in the meantime, auto-redial is cancelled.
- To cancel a retry, lift and replace the handset.

## Pulse to Tone Changeover

When making an outside call on a pulse dial (mechanical or rotary) line, press the [#] button. All digits dialled subsequently will be sent as tones.

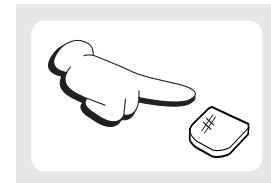

## Conference Calls

You can make a conference call with a group of up to five parties, including yourself. These can be other extensions and outside lines in any combination. The OfficeServ system allows some stations to pre-assign up to five conference groups so you can set up a conference call by simply pressing a programmable [Group Conference] button. (See **Programming Conference Groups**, below.)

1. Call the first number to be included in the conference and press the [Conference] button when answered. You will hear conference tone.
2. Make another call, either intercom or outside.
3. When answered, press the [Conference] button. You will hear conference tone again.
4. Repeat steps 2-3 for each party you wish to connect. When the final party answers, press the [Conference] button twice to connect all callers.

### To drop a party from your conference call

Press the [Conference] button and dial the extension or outside line number to be dropped.

Press the [Conference] button again to reestablish the conference.

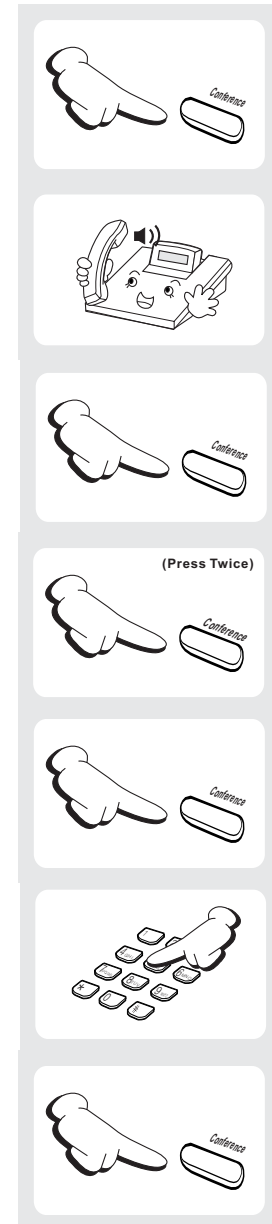



When attempting to add a party to the conference and you are not able to reach them, simply press the [Conference] button again.

## Programming Conference Groups

(Refer to your system administrator to confirm that this option is available to you.)

1. Press the [Transfer] button.
2. Dial [1][1][8].
3. Select the required Conference Group number using the [▼ Volume▲] buttons and press the right soft button.
4. Select 'Name' and press the right soft button to enter the Conference Group name. (Refer to the **Appendix** for how to enter characters.) Press the right soft button to save the name.
5. Using the [▼ Volume▲] buttons, select [MBR1–4] and press the right soft button
6. Dial the extension number or outside telephone number, remembering to dial the trunk access code first, and press the right soft button.
7. Repeat steps 5 and 6 to add conference group members
8. Save the settings by pressing the [Transfer] button.

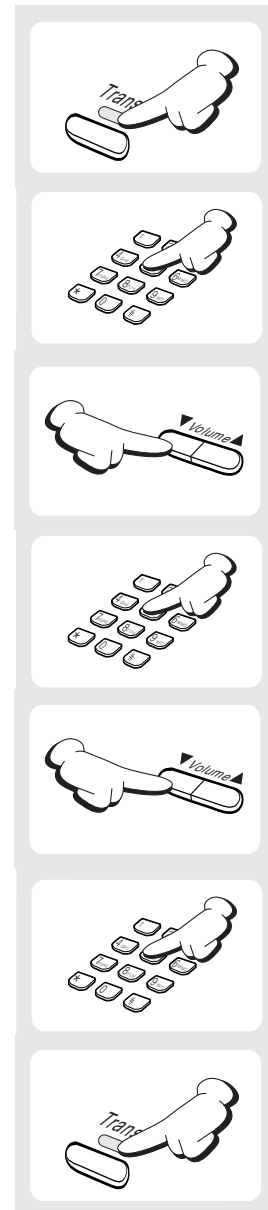

---

## **Making a Group Conference Call**

Press the programmed [GCONF] button followed by the group number (1–5). The conference will be set up automatically.

You can set up a [GCONF] button for each group by adding extenders (1–5) if preferred.

## Chapter 7 Call Pickup

This chapter explains how to intercept (pick up) a call that is ringing at another extension.

### Station Call Pickup

If a call rings at another extension and you know the extension number:

1. If the hot keypad feature is switched off, pick up the handset or press the [Speaker] button.
2. Dial [6][5].
3. Dial the number of the ringing extension.

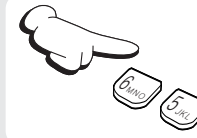
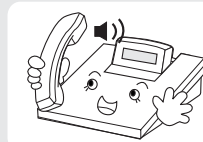

## Group Call Pickup

Extensions may be assigned to call pickup groups. If this is the case, when a call rings at another extension, and you know the pickup group number:

1. If the hot keypad feature is switched off, pick up the handset or press the [Speaker] button.
2. Dial [6][6] and dial the pickup group number.

Or

Press the flashing [GROUP PICKUP] button, if programmed,.

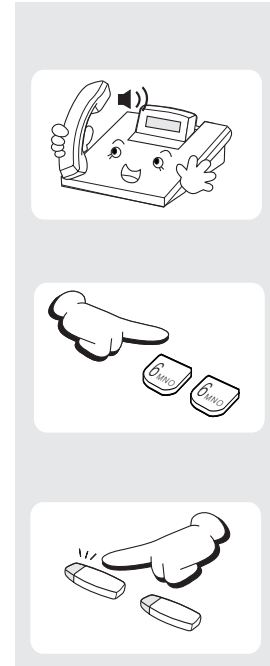

NOTE

- A station number (extender) can be assigned to the [GROUP PICKUP] button.
- Station Call Pickup and Group Call Pickup cannot answer the recalls arriving on stations, and are only used for newly incoming calls (external/internal) and operator recalls.

---

## Chapter 8 Call Forwarding

This chapter explains how you can forward calls sent to you. The main reasons for doing this are to allow someone else to answer your calls—or to record the calls if you have voice mail set up for you—if you are unable to answer calls for any reason, or to redirect calls to another phone you are temporarily using.

Refer to **Setting Call Forward Type and Destination** in Chapter 5 for a description of forwarding types, and how to use the menus to set forwarding. This chapter tells you how to set forwarding using the special dial codes programmed in the system.

If your phone has the FWD ALL, FWD BUSY, and FWD NO ANSWER buttons programmed, you can set the type of forwarding required by pressing one of the buttons. In this case, the button LED lights to indicate which forward option is enabled. Otherwise, use the dialling codes as described below.

### **Cancelling Call Forwarding**

To cancel any forwarding options you set (except Forward DND), dial [6][0][0].



## Forwarding All Calls

To forward **all** calls sent to your phone:

1. Dial [6][0][1].
2. Enter the extension number, group number, or external number where your calls are to be sent
3. Hang up after the attention tone.

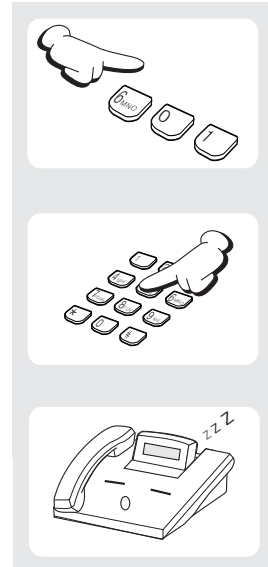

NOTE

- The extension receiving the forwarded calls can transfer the call back to your extension. This feature is useful when you are expecting an important call and do not want to be disturbed by other calls.
- If you set Forward All Calls and there is no [FORWARD ALL] button, the [Transfer] button lights.

## Forward Busy

To forward calls arriving when you are busy on another call:

1. Dial [6][0][2].
2. Enter the extension number, group number, or external number where your calls are to be sent.
3. Hang up after the confirmation tone.

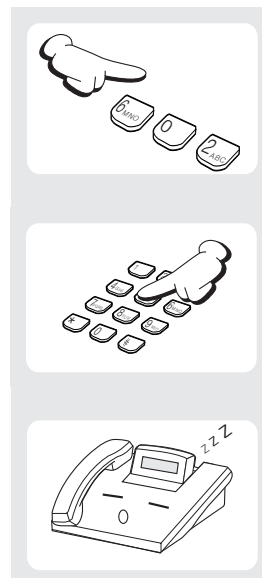

## Forward No Answer

To forward calls arriving when you are away from your desk (calls will ring and then be forwarded after a set time):

1. Dial [6][0][3].
2. Dial the extension number, group number, or external number where your calls are to be sent.
3. Hang up after the confirmation tone.

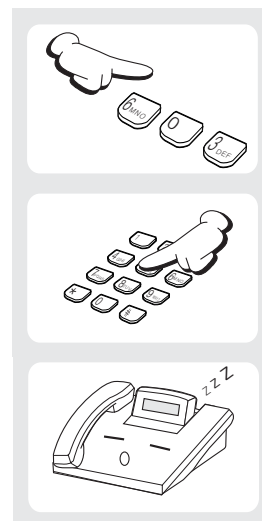

## Forward Busy/No Answer

If the Forward Busy and Forward No Answer options are both already set, calls are forwarded to the numbers specified for each of the options. You can select to have both options enabled at the same time.

1. Dial [6][0][4].
2. Hang up after the confirmation tone.

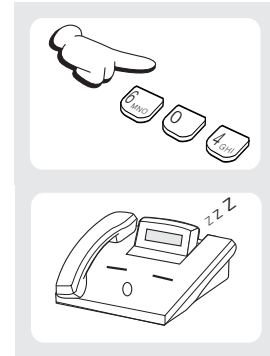

## Forward DND

Normally, when you set your phone in Do Not Disturb (DND) mode, incoming callers hear busy tone. If you select Forward DND, calls are forwarded to another destination when you put your phone in DND mode. Forward DND is cancelled when you cancel DND mode.

1. Dial [6][0][5].
2. Dial the extension number, group number, or external number where your calls are to be sent.
3. Hang up after the confirmation tone.

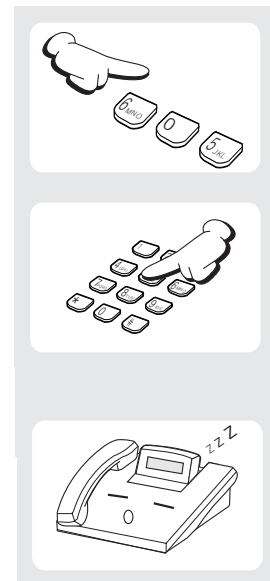

## Forward Follow Me

This feature has two purposes. The first is to allow you to transfer calls ringing at your normal extension to the extension you are currently using. The second is to allow you to transfer calls from another extension to your own (called Remote Forwarding).

**To transfer all calls ringing at your phone to the phone you are currently using:**

1. Dial [6][0][6] on the phone you are currently using.

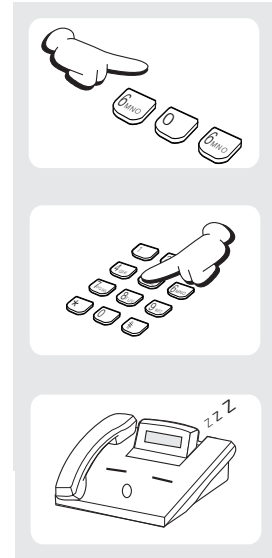

2. Dial your normal extension number.



3. Hang up after the confirmation tone.

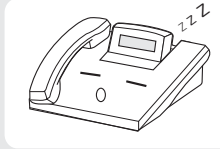

### To transfer calls from another extension to your extension (Remote Forwarding):

1. Dial [6][0][6].
2. Dial the number of the extension from which calls are to be forwarded.
3. Hang up after the confirmation tone.

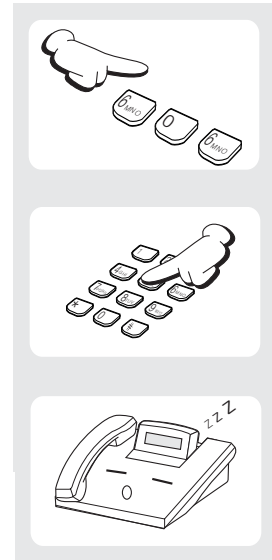

### Viewing and Changing Call Forward Options

You can view or change your Call Forward options from the LCD panel of your phone.

1. Press the [Transfer] button.
2. Dial [1][0][2].
3. Select the Call Forward option by pressing one of the buttons [0] to [5], or by using the [ ▼ Volume ▲ ] buttons.

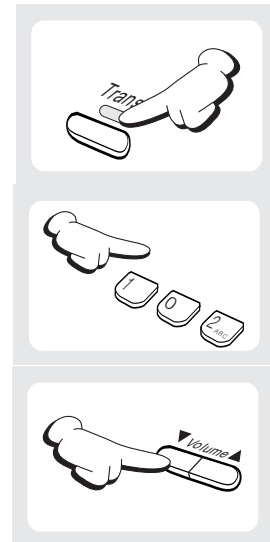

## Chapter 9 Paging and Messaging

This chapter explains how to use the paging and messaging features your system supports. You must use your handset when paging.

### Internal Page

You can make internal announcements to extensions through their speakers. Extensions can be in page zones 1-4.

1. Lift the handset and listen for dial tone.
2. Press the [PAGE] button\* or dial [5][5], or select the PAGE option from the LCD panel using the soft button.  
\*If you have dedicated PAGE buttons for page zones (e.g. [PAGE1], [PAGE2], etc) press the required button and skip to step 4.
3. Select a zone number [1], [2], [3], or [4], or page all internal zones by pressing [0].
4. Start your announcement after the confirmation tone.
5. Hang up after paging.

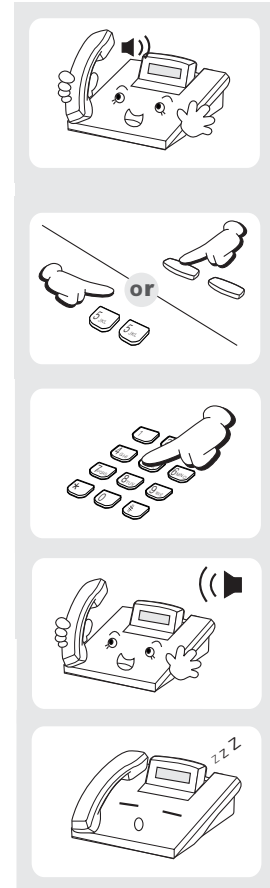

## External Page

You can page externally through external speakers rather than individual phone speakers. There are four external page zones numbered 5-8.

1. Pick up the handset and listen for dial tone.
2. Press the [PAGE] button or dial [5][5], or select the PAGE option from the LCD panel using the soft button.  
\*If you have dedicated PAGE buttons for page zones (e.g. [PAGE5], [PAGE6], etc) press the required button and skip to step 4.
3. Select a zone number [5], [6], [7], or [8], or page all external zones by pressing [9].
4. Start your announcement after the confirmation tone.
5. Hang up after paging.

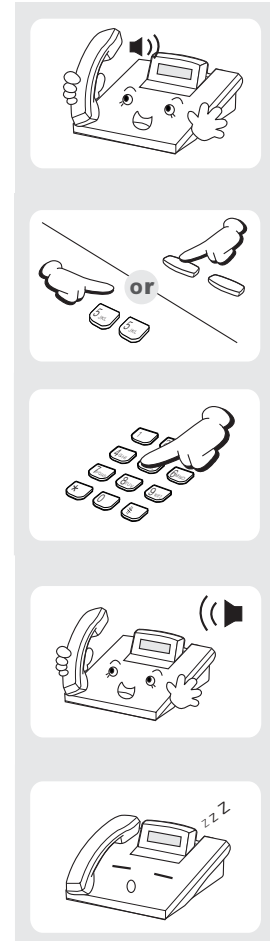

## All Page

You can page simultaneously through all internal and external zones.

1. Pick up the handset and listen for dial tone.
2. Press the [PAGE] button or dial [5][5], or select the PAGE option from the LCD panel using the soft button.
3. Press the [\*] or programmed [ALL PAGE] button.
4. Start your announcement after the confirmation tone.
5. Hang up after paging.

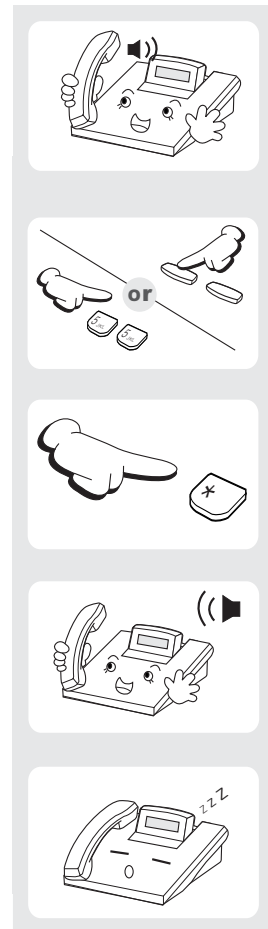



## Meet Me Page: MMPG

If you cannot directly contact someone or they are absent from their desk, you can page them and ask them to call you while you wait off-hook.

1. Pick up the handset and listen for dial tone.
2. Press the programmed [MMPG] button or dial [5][4], or select the MMPG option from the LCD panel using the soft button.
3. Press the zone number.
4. After the confirmation tone, instruct the paged party to dial [5][6].
5. Press the [Transfer] or programmed [WAIT] button.
6. Do not replace the handset. Wait for the paged party to call.
7. The call is automatically connected when the paged party enters the Meet Me Page Answer code.

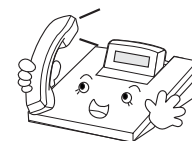
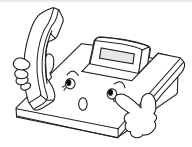
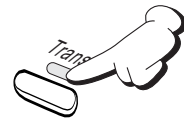
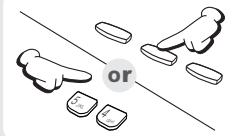
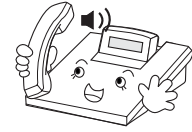

## Call Park and Page

You can transfer an external call to another extension by “parking” the call and notifying the call through paging. This function is useful in a factory or in a large office when you cannot easily contact the person who should receive the call.

1. Press the [PAGE] button or select the PAGE option from the LCD panel using the soft button to automatically park the call.  
If you have dedicated PAGE buttons for page zones (e.g. [PAGE5], [PAGE6], etc) press the required button and skip to step 3.
2. Press the appropriate page zone number
3. Announce the parked call and your extension number or line number.
4. Hang up.

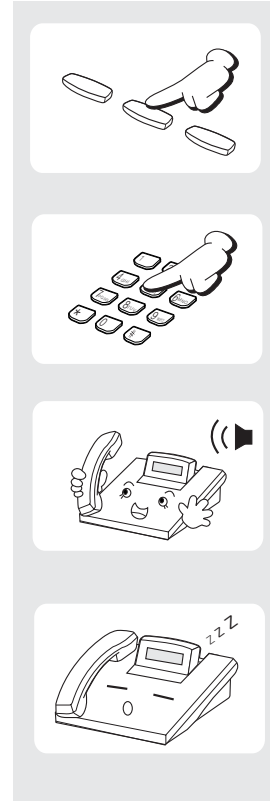

NOTE

If the parked call is not retrieved within a pre-programmed time limit, it will recall your phone and an amber light will blink slowly on a button.

Intercom calls cannot be parked and paged.

## Retrieving a Parked Call

Press the [PARK] button or dial [1][0]. Then dial the announced number.

The parked call is connected.

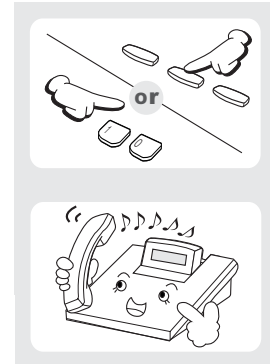

## Rejoining a Page

This option allows you to listen to remaining parts of internal page announcements after you finish a call. To enable this option:

1. Press the [Transfer] button and dial [1][1][0].
2. Dial [0] [5] [1] to enable this option, or [0][5][0] to disable it.
3. Press the [Transfer] button to save the setting.

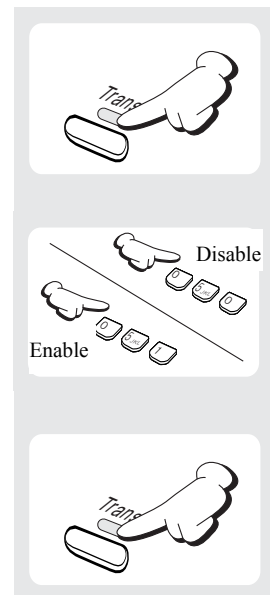

## Setting a Message Waiting Indication

If a called extension does not answer or the line is busy, you can leave a message waiting indication. This informs the user that you wish to talk with them.

1. Press the [Message] button or dial [4][3].

2. Hang up after the confirmation tone.

The [Message] button—and keyset status indicator, if it has one—on the receiving extension will flash red. Phones without a [Message] button will receive special dial tones as a message indication.

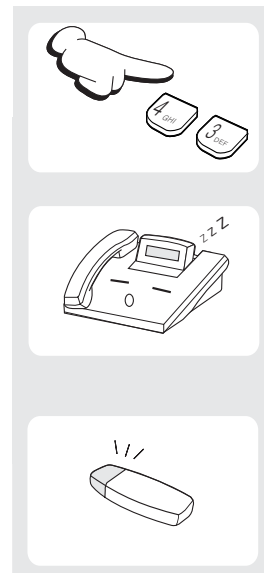

**If you wish to set an indication on an extension *without* first calling that extension:**

Dial [4][1], enter the extension number and hang up.

## Replying to Message Waiting Indications

If one or more message waiting indications have been left on your phone, your [Message] button LED and keyset status indicator will flash red. Up to five message indications from different extensions may be left.

### Replying Without Viewing Messages

1. Press the [Message] button or dial [4][3].
2. The first extension that left its number will be called automatically.
3. The LEDs on your phone will remain flashing until the extension responds. If there is no response, try again later or cancel the message (see **Cancelling Messages**).
4. Repeat the above procedure to respond to extensions in the order that messages were received.
5. The LEDs on your phone will go off when all messages are returned or cancelled.

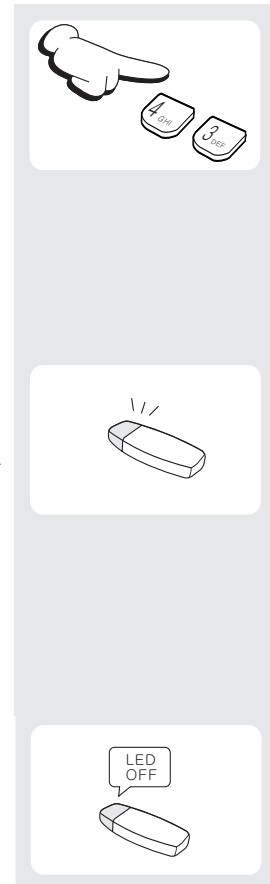

If a message was left at your phone by a phone in Auto Answer mode, the message must be cancelled manually after returning the message (see **Cancelling Messages**, below).

## Replying After Viewing Messages

You can view all extension numbers leaving indications before replying to them. This way you can reply to them in any order you choose.

1. Press the [Message] button.

The first extension that left its number is displayed on the LCD.

2. Press the [▼ Volume▲] buttons to scroll through extensions and select an extension.

3. Use the soft button to select REPLY or CLEAR (cancel the message without replying).

Do the same for each number displayed.

4. Press the [Speaker] or [End] button to finish.

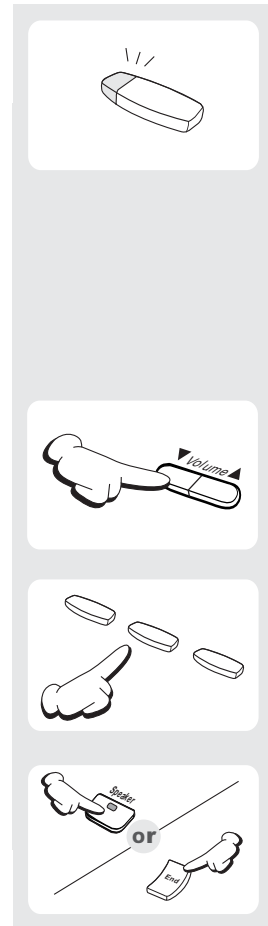

## Cancelling Messages

You can cancel message indications you left on other extensions, or that have been left at your extension by others.

Press [4][2] and enter:

. the extension number where you left the indication,

or

. your extension number to cancel all indications left by others for you (the flashing LEDs go out)



Messages left at your phone can also be cancelled separately by viewing them first. See **Replying After Viewing Messages**, above.

## Programmed Messages

If you need to leave your station, you can set a message display on your phone to inform callers of your absence (for example “In a Meeting”). The message also displays on your phone’s LCD panel. Some standard messages are already set in the system, and you create your own if you wish.



System messages are numbered 00-15. (A list of default messages is provided in the Appendix.) You can create up to five of your own using code numbers 16-20.

## Viewing and Selecting a Programmed Message

To view and select a set message:

1. Press the [Transfer] button and dial [1][1][5].
2. Use the [▼ Volume▲] buttons to scroll through the programmed messages.
3. Press the [Transfer] button to select your message. It will display on your LCD panel.

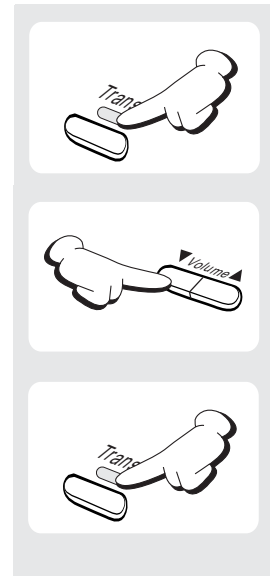

## Selecting a Programmed Message Using Code Numbers

Dial [\*][4][8] and dial the desired message number 00-20.

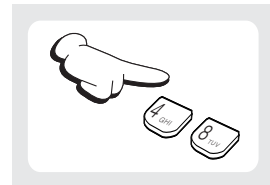



## Creating Your Own Message

Personalised messages can be programmed using codes 16 to 20. To create a personalised message on your phone:

1. Press the [Transfer] button and dial [1][1][5].
2. Dial a code number 16-20
3. Enter your message (up to 16 characters)  
See the **Appendix** for the procedure for entering text.
4. Press the [Transfer] button to set your message

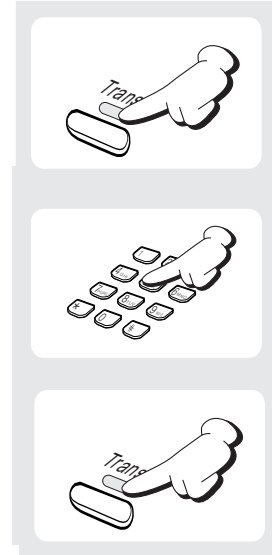

## Cancelling a Programmed Message

Dial [4][8] then [0][0] to cancel the message.

Your LCD display returns to normal

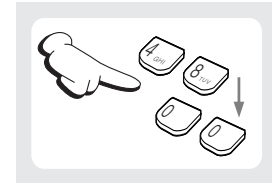

NOTE

You may have multiple programmed message buttons, each having a different message code.

Press any programmed message button. A red light comes on the button's LED indicating that the message has been set. Press the button again to clear the message.

Pressing another programmed message button while a message is displayed will clear the message and set the new message.

## Chapter 10 Special Features

This chapter describes the following features:

Setting Do Not Disturb (DND) mode and One-Time DND

Muting your phone

Listening to background music

Setting appointment reminders/clock alarms

Using a door phone

Using an executive/secretary hotline

Group listening

Locking and unlocking your phone

Off-hook voice announcements

Removing your phone from a group and re-entering

Setting timers

Setting ring preference (the order in which you answer calls)

### Do Not Disturb

When Do Not Disturb mode is set, calls to your phone are blocked. However, you can still make outgoing calls.

### Setting Do Not Disturb

Press the programmed [DND] button or dial  
[4][0][1]  
(or select the DND option in the OTHER menu on the  
LCD panel using the Scroll and soft buttons)

The status indicator flashes and Do Not Disturb  
displays on the LCD.

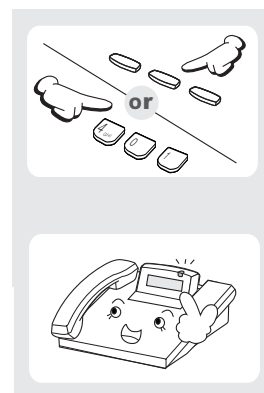



NOTE

If you want your calls to be answered by someone else while in DND mode, set your phone for Forward DND (see **Chapter 8**).

## Cancelling Do Not Disturb

1. Press the programmed [DND] button or dial [4][0][0].
2. The status indicator goes off.

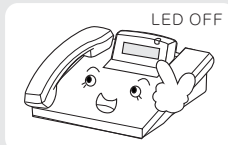
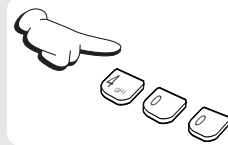

## One-Time DND

If you do not wish to be disturbed only while you are on your current call, press the programmed [DND] button and set your phone to Do Not Disturb. When you disconnect the call, the Do Not Disturb mode is automatically cancelled and new calls can be received. You need a programmed [DND] button for this.

## Muting Your Phone

The Mute feature prevents your voice being heard by the calling/called party.

1. During a call, press the programmed [MUTE] button (the button LED lights), or select the MUTE option from the LCD panel using the soft button (“MUTE” changes to “mute” on the LCD)
2. To cancel, press the [MUTE] button (the button LED goes off) or, select the MUTE option on the LCD panel (“mute” changes back to “MUTE” on the LCD)

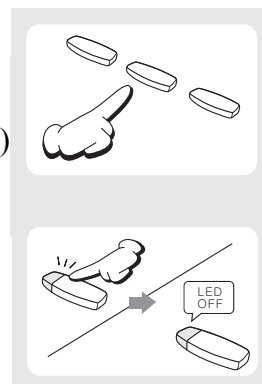

## Background Music

You can listen to music through the phone's speaker (if a music source is provided by the system).

1. Press the [Hold] button.
2. Use the [▼ Volume ▲] buttons to adjust the music volume. This does not affect the speaker volume.
3. Press the [Hold] button again to cancel music.

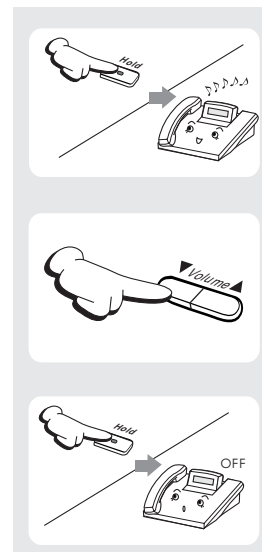

## Alarm Features

### Appointment Reminder/Alarm Clock

This feature serves as an alarm clock. Up to three alarms may be set. Each alarm may be set as a one-day (today) alarm or daily alarm. You set a time for each alarm: if set for today it will ring at the set time, unless cancelled; if set as a daily alarm it will ring at the set time each day, unless cancelled.

When activated, you will hear a series of short rings and “Alarm Reminder” displays on the LCD. Lift the handset to answer the alarm. If you do not answer, the alarm will repeat a number of times at set intervals before cancelling.

1. Press the [Transfer] button.
2. Dial [1][1][2].
3. Select the alarm number [1], [2] or [3].
4. Enter the time at which you want the alarm to sound. Enter the time as HHMM (hours and minutes) using the 24-hour clock format (e.g. 1330 is 1.30 pm).
5. Select the alarm type: [0] (Not Set), [1] (Today) or [2] (Daily).
6. Press the [Transfer] button to save settings.

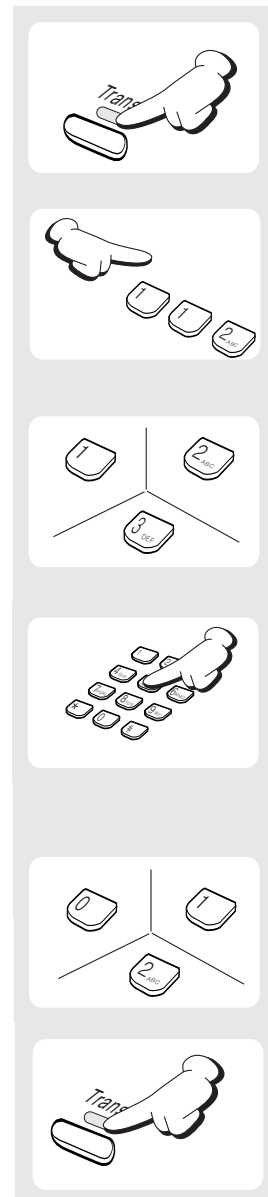

## Cancel Alarm

1. Press the [Transfer] button.
2. Dial [1][1][2].
3. Select the alarm number [1], [2] or [3].
4. Press the [Hold] button.

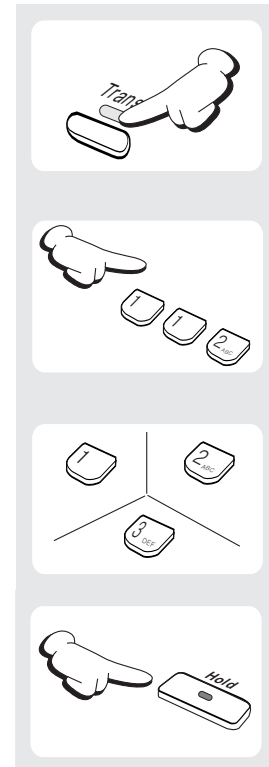

You can set an alarm message to display on the LCD panel when the alarm sounds. Refer to the next section, **Alarm Messages**, for details.

## Alarm Messages

You can set a 16-character message to display when using the alarm feature (e.g. “Meeting with JS”).

1. Press the [Transfer] button.
2. Dial [1][1][6].
3. Select the alarm number [1], [2] or [3].
4. Enter the time at which you want the alarm to sound. Enter the time as HHMM (hours and minutes) using the 24-hour clock format (e.g. 1330 is 1.30 pm).
5. Select the alarm type: [0] (Not Set), [1] (Today) or [2] (Daily).
6. Enter the message using the dial buttons.  
Refer to the **Appendix** for the procedure for entering messages.
7. Press the [Transfer] button to save the alarm and message.

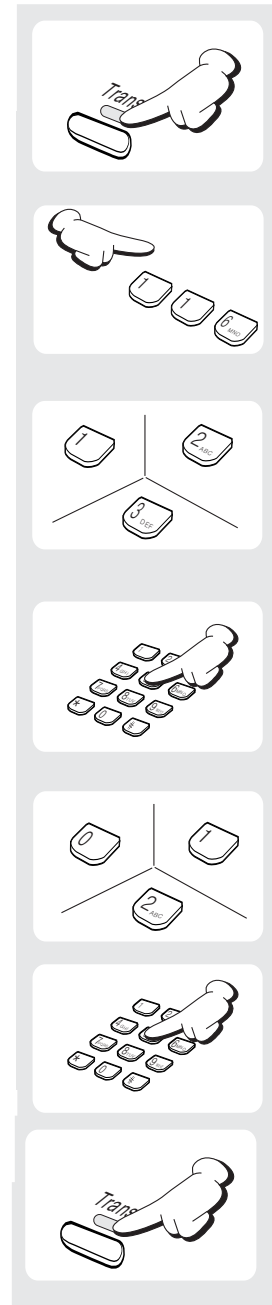

## Cancel Alarm Message

To cancel a message (but not the alarm):

1. Press the [Transfer] button.
2. Dial [1][1][6].
3. Press the alarm number [1], [2] or [3].
4. Press the right Soft button twice.
5. Press the [Hold] button to cancel the message.

(To cancel the alarm, see **Cancel Alarm**, above.)

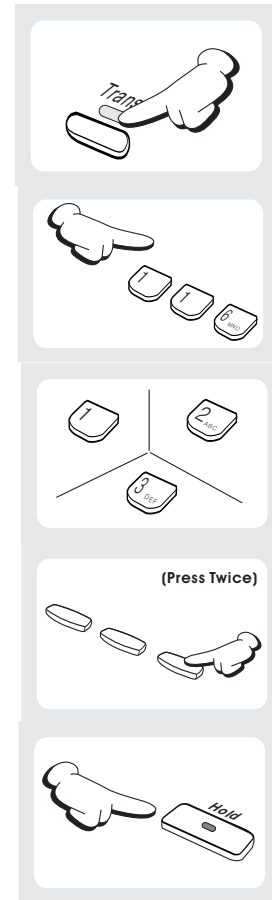



## Using the Door Phone

### Answering the Door Phone

You can answer calls from the door phone or open the door from your phone.

1. A call from the door phone repeats briefly three times.
2. Lift the handset or press the [Speaker] button or the [Call] button to connect to the door phone.
3. If an electric door lock is installed, you can open the door by dialling [1][3].

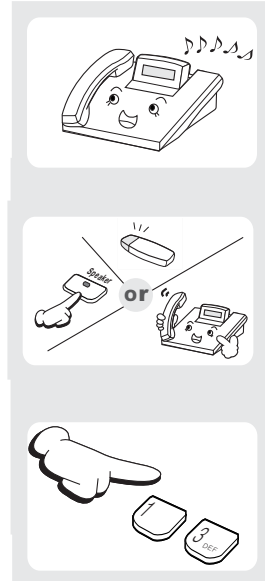

### Calling The Door Phone/Room Monitor

You can call the door phone and talk or listen to what is happening outside or in another room.

1. Dial the number of the door phone.
2. Listen or talk when connected.
3. If an electric door lock is installed, you can open the door by dialling [1][3].

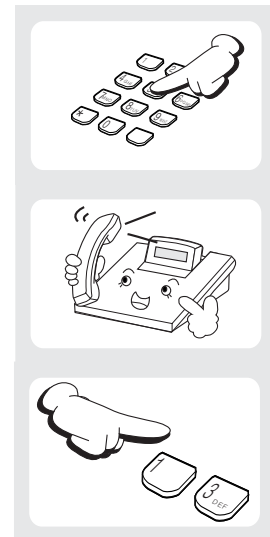

## Executive/Secretary Hot Line

Phones for executives and secretaries can be connected via a “hot line”.

- Either phone can make a call to the other by pressing the [BOSS] button or by selecting the BOSS option on the LCD panel using the soft button.
- If DND is set on the executive’s phone, all calls will be forwarded to the secretary’s phone.

When the secretary’s phone receives the call, a red light flashes on the executive’s phone.



The secretary can transfer calls to the executive’s phone even when set in DND mode:

1. Press the [Transfer] button then the [BOSS] button, or select the BOSS option from the LCD panel using the soft button.
2. Either wait until the executive answers and announce the call, then hang up, or hang up without announcing the call.

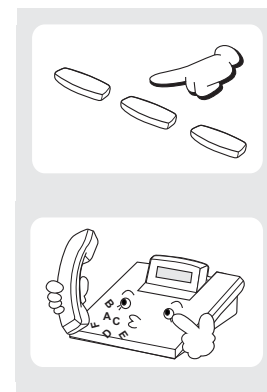

## Group Listening

While you are on a call using the handset, you can allow others to hear the conversation through your phone's speaker.

1. Turn on the speaker by pressing the programmed [LISTEN] button or selecting the LISTN option on the LCD panel\* using the Scroll button and soft button. Do not replace the handset.

The microphone is not switched on, so the calling/called party cannot hear anyone else in the office.

\* ("LISTN" changes to "listn" on the LCD)

2. To resume a private conversation, press the [LISTEN] button again, or select the 'listn' option on the LCD panel\* using the soft button

\* ("listn" changes back to "LISTN" on the LCD)

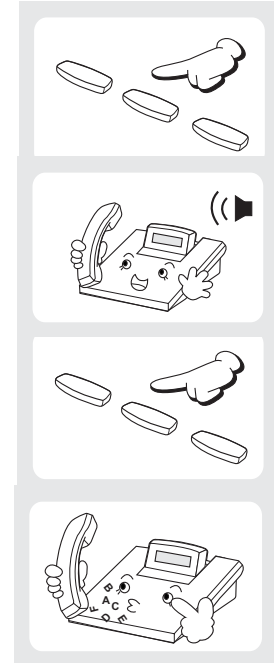

NOTE

It is advisable, but not essential, to turn the group listening feature off before hanging up to prevent any "squeal" from the speaker.

## Locking and Unlocking Your Phone

You can lock your phone to prevent its unauthorised use while you are away. You can then unlock the phone when you return. The phone can be prevented from making or receiving any calls (LOCKED ALL option) or from making outside calls only (LOCKED OUT option).

1. Press the [Transfer] button and dial [1][0][0]
2. Dial your 4-digit station passcode (normally '1234', unless this has been changed)
3. Press [1] for LOCKED OUT or [2] for LOCKED ALL or Press [0] to UNLOCK your phone  
If you select [1] the [Hold] button flashes.  
If you select [2] the [Hold] button lights steady.
4. Press the [Transfer] button to save settings.

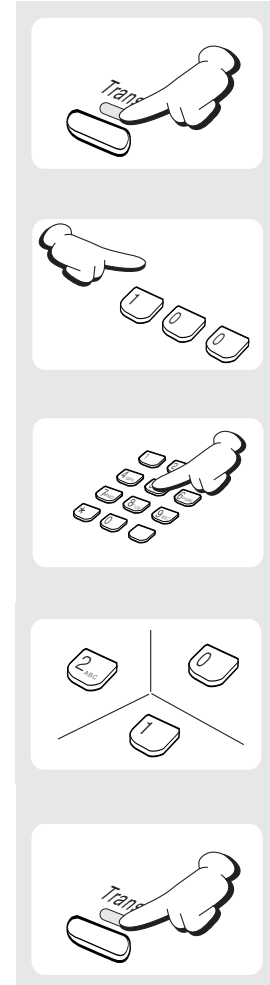

## Off-Hook Voice Announcements

You can make an announcement (OHVA call) through the handset or speaker of a phone that is currently busy on a call. This feature is useful when you have an urgent message to deliver. You must have a programmed [OHVA] button to do this. OHVA calls cannot be made to phones in DND mode or which have an OHVA block set (see below). The OHVA feature works with intercom and transferred calls.

To make an OHVA call:

1. Dial the extension number or press the [DSS] button.
2. When you hear busy tone, press the [OHVA] button or select the OHVA option from the LCD panel using the soft button.
3. Make your announcement after the confirmation tone.
4. Finish the call by replacing the handset, or pressing the [Speaker] button.

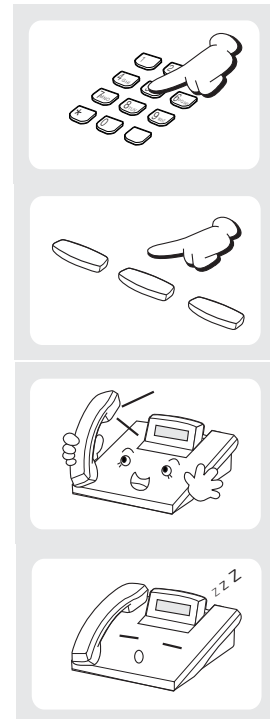

When making an OHVA to a nearby station, use the handset to avoid an echo.

## Answering an OHVA Call

When receiving an OHVA call, you will hear the announcement through your handset or speaker depending on which you are using. In either case, you can answer the call before continuing your current call.

1. Press the flashing [Call] button. This places your current call on hold and allows you to talk to the announcing party.

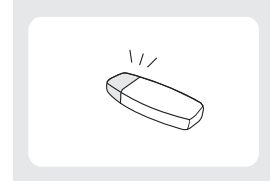

2. To disconnect the OHVA call and return to your original call, press the button for the original call.

## Rejecting an OHVA Call

When receiving an OHVA call, press the programmed [REJECT] button or select the REJECT option from the LCD panel using the soft button.

This will disconnect the OHVA call and return you to the original caller.

## OHVA Block

You can set an OHVA block to prevent OHVA calls at your phone. While the phone is idle, press the programmed [BLOCK] button or select the OHBLK option from the OTHER menu on the LCD panel using the [Scroll] button and soft button.

Press the [BLOCK] button again, or turn off the OHBLK option, to cancel the block.

## Secure OHVA

This option prevents your phone from receiving OHVA calls via the speaker, for privacy. Any OHVA call is broadcast via the handset only when the SECURE OHVA option is turned on at your phone.

1. Press the [Transfer] button
2. Dial [1][1][0]
3. Dial [1][3][1] to switch Secure OHVA on, or [1][3][0] to switch it off
4. Press the [Transfer] button to save settings.

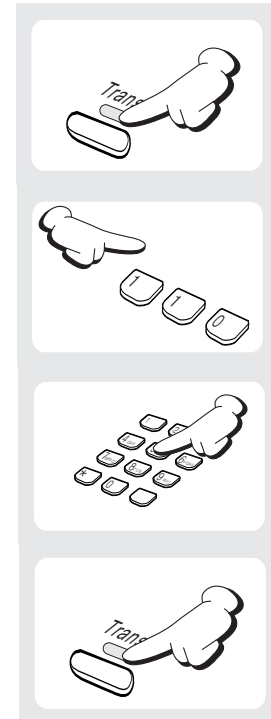

## In Group/Out Of Group

If your phone is assigned to a station group, you can remove it from the group or reassign it to the group if it has been removed. If removed from the group you cannot answer calls sent to the group number, only calls to your extension number.

- **If you have a programmed [IN/OUT] button:**

1. Press the programmed [IN/OUT] button.  
The button will light red.



2. Press the [IN/OUT] button again to remove the phone from the group. The LED goes off.
3. To rejoin the group, press the [IN/OUT] button again. The button lights red.

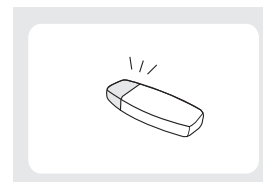
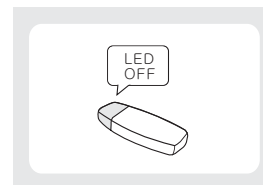

NOTE

If your phone is in more than one group, you can assign an extension number (extender) to an [IN/OUT] button for each group. This way, you can decide for which group you will receive calls.

- **Using the LCD Menu**

Select the IOG option from the OTHER menu on the LCD panel using the [Scroll] button and soft button. Enter the group number and select to exit (leave the group) or enter (rejoin the group) as appropriate.

## Call Duration Timer

The call timer is used to time the duration of external calls. It can also be manually set to time a call or as a simple stopwatch feature.

### Setting Automatic Timer

If set, the timer appears on the LCD panel immediately for incoming calls, or when your call is answered after dialling an outgoing call. It remains active during the call. The call duration is displayed in minutes and seconds, and is reset if the call lasts longer than 100 minutes.



1. While on-hook, press the [Transfer] button.
2. Dial [1][1][0].
3. Dial [0][1][1] to activate the auto timer or [0][1][0] to deactivate it.
4. Press the [Transfer] button to save settings.

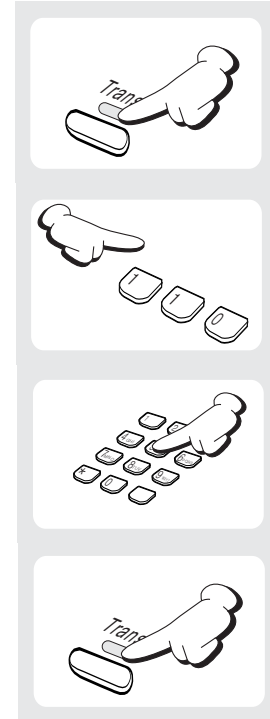

### Setting Manual Timer

To set the timer manually when on a call, you must have a programmed [TIMER] button. Press the button to start the timer, and press it again to stop the timer.

To start the timer while the phone is idle, press the [TIMER] button or select the TIMER option from the OTHER menu on the LCD panel using the [Scroll] and soft buttons.

Press the [TIMER] button again or select TIMER from the LCD panel to stop the timer and confirm the elapsed time displayed.

Lift and replace the handset to return the phone to its normal LCD display.

## Ring Preference

This option, when enabled on your phone, allows you to answer calls simply by lifting the handset or pressing the [Send] or [Call] button. Calls are answered in the order that they arrive at your phone. If Ring Preference is switched off, you must answer calls by pressing the flashing [Call] or line buttons, and you may answer the calls in any order, irrespective of their order of arrival.

1. Press the [Transfer] button.
2. Dial [1][1][0].
3. Dial [0][6][1] to switch ring preference on, or [0][6][0] to switch it off.
4. Press the [Transfer] button to save the settings.

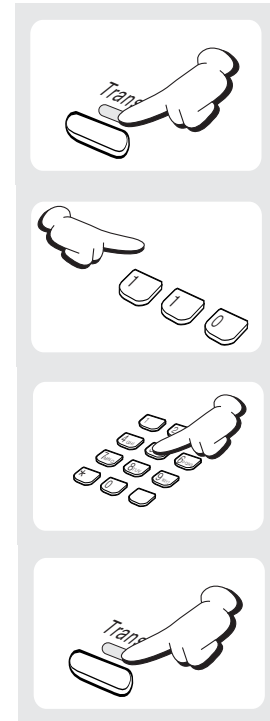

## Chapter 11 Caller Identification (CLIP)

Caller ID or Calling Line Identification Presentation (CLIP) is provided by your telephone company and allows you to view numbers and/or names of callers on your LCD panel.



NOTE

If no CLIP information is available for a number, it may be for one of these reasons:

- the caller requests that their ID not be sent;
- the call is from an area where CLIP service is not available (e.g., international calls);
- the call is from the telephone company;
- CLIP information is corrupted;
- the telephone company does not support CLIP information.

### Viewing Number or Name of Caller

With CLIP, a caller's number can be displayed at your phone. If a name is associated with the number in the system, the name can also be displayed. You decide whether the caller's name or number is displayed first when a call is received. There are three options:

- NAME FIRST.
- NUMBER FIRST.
- NO DISPLAY (do not display CLIP information).



NOTE

Whichever option you select (name or number), you will still be able to view the other information at the touch of a button. For example, if you select NAME FIRST, the caller's name will display on your LCD panel. To view the number, simply press the soft button for the NND option.

To select your preference:

1. Press the [Transfer] button.
2. Dial [1][1][9].
3. Press [1] to view the number first, or [2] to view the name first, or [0] for no display  
(Or, use the [▼ Volume ▲] buttons to select.)
4. Press the [Transfer] button to save settings.

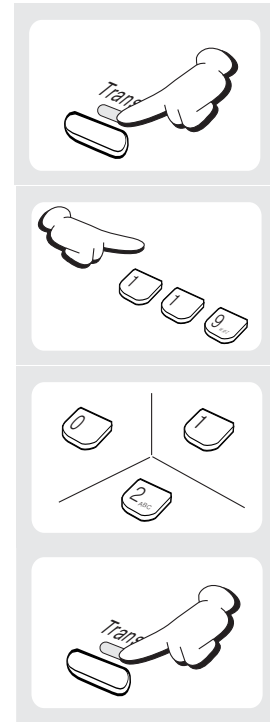

## Viewing Next Caller CLIP

If you have a call waiting or camped-on at your phone, press the programmed [NEXT] button or select the NEXT option from the CLIP menu on the LCD panel using the [Scroll] and soft buttons. The caller's name or number is displayed depending on the option you selected (see previous section).

## Storing a Caller Number

While you are on a call, you can store the number in memory by pressing the programmed [SAVE] button or selecting the SAVE option from the CLIP menu on the LCD screen using the [Scroll] and soft buttons.

## Calling a Stored Number

To redial a stored number, dial [1][7].

(If the hot keypad feature is switched off, lift the handset or press the [Speaker] button first.)

## Storing a Caller Number as a Speed Dial Number

You can store a caller's number as a speed dial number in your personal speed dial list.

1. Press the programmed [STORE] button, or select the STORE option in the CLIP menu on the LCD panel.
2. You can view the speed dial number to which the number was stored by pressing the [Scroll] button.

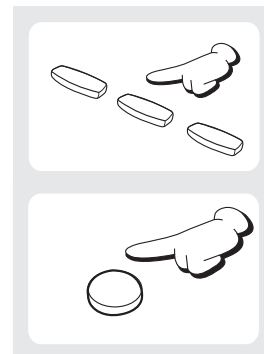

## Viewing CLIP for Calls on Hold or Parked

When an incoming call is on hold or parked for you, you can view CLIP information and decide how to handle the call before answering.

1. Press the programmed [INQUIRE] button or select the INQUIRE option from the CLIP menu on the LCD panel using the soft buttons.
 

If you are currently on a call, that call will be put on hold (see the Note, below).
2. Dial the C.O. line number holding the call.
3. Press the [Call] button to answer the call, or the NND soft button to view more information on the call, or the IGNORE soft button to ignore the call.

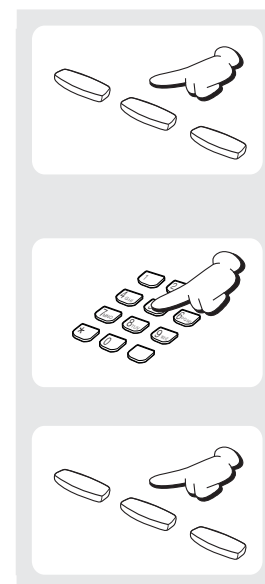



If you are currently on an intercom call or you have cleared the automatic hold feature, you must either disconnect the call or put it on hold.

If you perform the above procedure for an external call, the message [call no longer available] will be displayed on screen.

## Viewing CLIP for Previous Calls

You can view CLIP information for up to 50 of the most recent calls you received. Call information is stored in memory on a “first-in first-out” basis. The list also includes calls that rang but were not answered. While reviewing the list, you can press a button to dial the number currently displayed.

1. Press the programmed [REVIEW] button, or select the REVW option from the CLIP menu on the LCD panel using the [Scroll] and soft buttons.

The oldest call is displayed.

2. Press the, DIAL soft button to redial the number  
or  
Press the NND soft button to view more information  
or  
Press the CLEAR soft button to delete the number  
or

Store the number in your personal speed dial list by pressing the [Scroll] button and selecting the STORE option from the CLIP menu on the LCD panel.

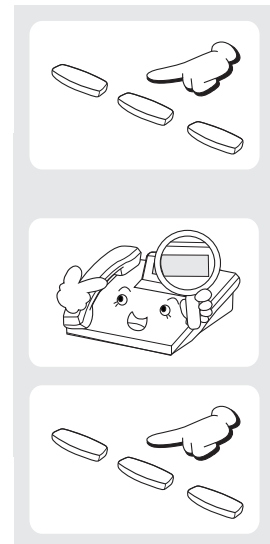

## Appendix: Additional Information

### System Feature Codes

ITP-5000D series phones have the following default feature codes. You can dial these codes if there are no programmed buttons for the desired features.

Be aware that these codes can be changed in programming. If a code does not work as shown here, check with your system administrator for the correct code(s).

Dial Code	Feature	Dial Code	Feature
10+ext. no.	Answer parked calls	49	Send flash
11	Put calls on and take calls off hold	5xx(x)	Station groups
12+ ext. no.	Answer call on hold at another station	53+grp+0	Exclude group
13	Release door lock	53+grp+1	Include group
16+spd no.	Assign speed dial number	54+zone	Meet Me Page
17	Dial stored number	55+0	Page all internal zones
19	Last Number Redial	55+1	Page internal zone 1
2xx(x)	Extension numbers	55+2	Page internal zone 2
3xx(x)	Extension numbers	55+3	Page internal zone 3
400	Cancel DND	55+4	Page internal zone 4
401	Set DND	55+5	Page external zone 1
41	Set Message (no ring)	55+6	Page external zone 2
42+ext. no.	Cancel message	55+7	Page external zone 3
43	Set/Return message	55+8	Page external zone 4
44	Busy extension/line callback	55+9	Page all external zones
45	Busy extension camp-on	55+*	Page all zones
46	Set up conference	56	Answer Meet Me Page
47	Enter account code	57	Clear alarm sensor
48+msg no	Set programmed station message	58	Clear DISA Alarm

Dial Code	Feature	Dial Code	Feature
59	Walking class of service	65+ext. no.	Directed call pickup
600	Cancel all call forwarding	66+grp. no.	Group call pickup
601+no.	Set Forward All Calls	67	Universal Answer
602+no.	Set Forward Busy	681	Voice Dialler
603+no.	Set Forward No Ans	682	Record Voice Dialler
604+no.	Set Forward Busy/No Ans	7xx(x)	Individual line numbers
605 + no.	Set Forward DND	8xx	Trunk group numbers
606 + no.	Set Forward Follow Me		
0	Call System Operator	9	Outside dial code

## Programmed Messages

If you need to leave a message of absence on your phone and on calling phones while away from desk you can select one of the following default messages.

Be aware that these messages may be changed in programming.

Message code	Message
01	GIVE ME THE CALL
02	TAKE A MESSAGE
03	ASK THEM TO HOLD
04	SEND TO MY VM
05	TRSF TO MY SECY
06	LEAVE A MESSAGE
07	PAGE ME
08	OUT OF TOWN
09	IN A MEETING
10	I WILL CALL BACK
11–20	<BLANK>



## Entering Characters on the LCD Panel

Alphabetic characters are entered on the LCD panel using the dial buttons (button 2=ABC, button 3=DEF, and so on). Press a button the number of times to select the required character (e.g. press “2” three times for “C”). Pressing a different button moves the cursor to the right to allow you to enter the next character.\* For example, if the text to enter is “SAM SMITH”, press the number “7” four times to get the letter “S”; now press the number “2” once to get the letter “A” Continue selecting characters from the keypad to complete your entry. Press the programmable “A” button to toggle between upper and lower case text (see below).

\* Tip: When the character you want is on the same key as the previous character you typed in, press the [Volume ▲] button to move the cursor to the right, then select the character.

Enter characters as shown in the following table.

Dial button	No. of presses				
	1	2	3	4	5
0	Q	Z	.	)	0
1	Space	?	,	!	1
2	A	B	C	@	2
3	D	E	F	#	3
4	G	H	I	\$	4
5	J	K	L	%	5
6	M	N	O	^	6
7	P	Q	R	S	7
8	T	U	V	*	8
9	W	X	Y	Z	9
*	:	=	[	]	*

Press the [#] button to enter special characters. Special characters are displayed in the following order.

#	space	&	!	:	?	.	,	%	\$	-	<	>	/	=
[	]	@	^	(	)	_	+	{	}		;	"	→	`

## Switching Between Uppercase and Lowercase Characters

Use the “A” button to toggle between uppercase and lowercase characters. The “A” button is the left-most button of the bottom row of programmable buttons (as shown in the example, below.)

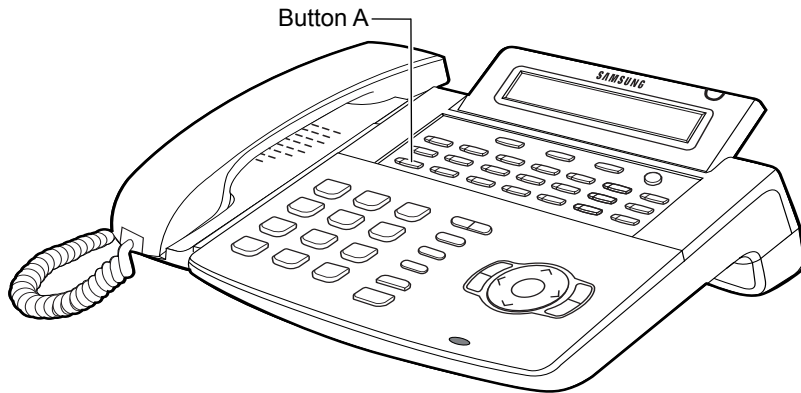

**Samsung Telecoms (U.K.) Limited**  
Brookside Business Park, Greengate, Middleton, Manchester M24 1GS

