

# Notice

**Copyright © 2008 Huawei Technologies Co., Ltd.**

## All Rights Reserved

No part of this manual may be reproduced or transmitted in any form or by any means without prior written consent of Huawei Technologies Co., Ltd.

## Trademarks



and HUAWEI are trademarks of Huawei Technologies Co., Ltd. All other trademarks and trade names mentioned in this manual are the property of their respective holders.

## Notice

The information in this manual is subject to change without notice. Every effort has been made in the preparation of this manual to ensure accuracy of the contents, but all statements, information, and recommendations in this

manual do not constitute the warranty of any kind, expressed or implied.

## Huawei Technologies Co., Ltd.

### Address:

Administration Building, Huawei Technologies Co., Ltd., Bantian, Longgang District, Shenzhen, P. R. China

**Postal Code:** 518129

**Website:** <http://www.huawei.com>

# Table of Contents

## Table of Contents 1

### Introduction 1

Packing List .....	1
Front View .....	1
Rear View .....	2
Screen Icons .....	3
Introduction to Menus .....	3

### Installation 4

Installing the Battery .....	4
Installing the SIM Card .....	4
Installing the Power Adapter .....	5
Installing the Indoor Antenna .....	5
Connecting the FWT to a PC .....	5
Mounting the FWT .....	6
Validating .....	6

### Basic Operations 7

Making or Answering Calls .....	7
Operations During a Voice Call .....	7
Text Input .....	7

### Contacts 9

Making Calls from Contacts .....	9
Searching for a Contact .....	9
Groups .....	9
Other Operations .....	10

### Messages 11

Text Messages .....	11
Voice Mail Number .....	13

Common Phrases .....	13
Delete All .....	13

### Call Log 14

Making Calls from Call Log .....	14
Other Operations .....	14

### Tools 15

Alarms .....	15
Calendar .....	15
Calculator .....	15
World Time .....	15

### Profiles 16

Selecting a Profile .....	16
Editing a Profile .....	16

### Settings 17

Phone settings .....	17
Display Settings .....	17
Call Settings .....	17
Network .....	18
Security .....	19

### Warnings and Precautions 20

# 1 Introduction

## Packing List

Item	Quantity
Main unit, handset, and coiled cord	1
Power adapter	1
Antenna (Optional)	1
Battery (Rechargeable)	1
Certificate of Quality	1
User Guide	1

### Note

- Select either an indoor or an outdoor antenna according to the local radio signal strength.
- To access the Internet, you need to purchase the required data suite. For more information, consult your local sales agent.

## Front View

### Note

The figures are only for your reference. The actual color and shape are subject to the delivered product.

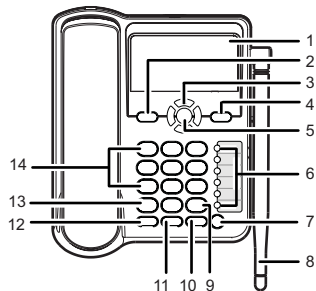

### Item

### Description

1 Screen	Display information.
2 Left soft key	Select the option displayed on the lower left corner of the screen.
3 Scroll keys	Access the shortcut screen in standby mode.
4 Right soft key	Select the option displayed on the lower right corner of the screen.
5 OK key	Access the main menu in standby mode.
6 Shortcut keys	Speed dial a phone number.

## Rear View





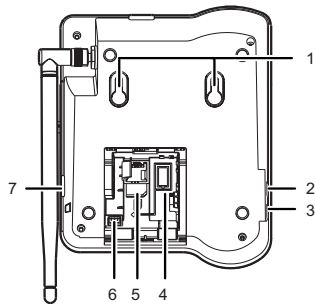









Item	Description
7 Call/Redial key	<ul style="list-style-type: none"> <li>• Make or answer a call.</li> <li>• View dialed calls in standby mode.</li> </ul>
8 Antenna	Receive signals.
9 # key	<ul style="list-style-type: none"> <li>• Press and hold it to switch between the silent and normal profiles.</li> <li>• Switch on/off the input mode of T9.</li> <li>• Mark/unmark a record.</li> </ul>
10 Headset key	Activate the headset.
11 Handsfree key	<ul style="list-style-type: none"> <li>• Make/answer a call without lifting the handset.</li> <li>• Cancel the dialing that is in hands-free mode.</li> <li>• End the call that is in handsfree mode.</li> </ul>
12 End key	<ul style="list-style-type: none"> <li>• End a call or reject an incoming call.</li> <li>• Press and hold it to power on or off.</li> <li>• Return to the standby mode.</li> </ul>
13 * key	<ul style="list-style-type: none"> <li>• Press and hold it to lock the keyboard in standby mode.</li> <li>• Switch between different input methods in text input mode.</li> </ul>
14 Number keys	Enter numbers and characters.

## Rear View







No.	Item	NO.	Item
1	Wall-mounting brackets	2	Headset port
3	Main unit spiral cord jack	4	Battery container
5	SIM card slot	6	Battery port
7	Data port		

## Screen Icons

Icon	Description	Icon	Description
	Calling		No service
	Alarm clock is on		Hands-free mode
	Message received		Powered by the power adapter
	Voice message received		Battery power level
	In a 3G network.		In a 2G network
	Headset mode		Keypad lock
	Network signal strength		In silent profile.
	Line 2 is selected		

## Introduction to Menu

Your FWT provides an extensive range of functions. You can use these functions by navigating the following menus: Contacts, Messages, Call log, Tools, Profiles and Settings.

- 1 In the standby mode, press left soft key or  to display the main menu.
- 2 Press  or  to move around the menus, and then press left soft key or  to select items.
- 3 If the menu contains further submenus, repeat Step 2.
- 4 Use the selected function according to the prompts on the screen.
- 5 Select **Back** to return to the previous menu.
- 6 Press  to return to the standby mode.

## 2 Installation

### Note

Before installing or removing the battery, indoor antenna or SIM card, switch off the FWT and disconnect the FWT from the power adapter. To prevent lightning from injuring human body, remove the outdoor antenna too.

## Installing the Battery

### Note

- When the ambient temperature exceeds the temperature allowed for charging, the system will stop charging the battery.
- When the power adapter is in use, the FWT will automatically charge the battery and stop it after the battery is fully charged.
- Take the battery out of the FWT if the FWT is left unused for a long period.
- Make sure that the battery has been charged for more than 8 hours before it supplies power for the FWT at the first time. The charging time depends on the environmental temperature and the age of the battery.
- For a battery that is not in use for a long time, you need to activate it, that is, charge and discharge the battery for two to three times.

Insert the connection cable of the battery into the battery port, make sure the insert direction is correct, and then place the battery into the battery container.



## Installing the SIM Card

### Note

The SIM card is easily to be damaged by scars on the contact area or overbending, so you should insert or remove it gently.

Insert the card to the card slot. Put the side with the bevelled corner of the card backwards and the side with the contact area of the card downwards. Make sure the card is completely inserted into the slot.



### Installing the Power Adapter

- 1 Make sure that the FWT is switched off.
- 2 Insert one end of the power adapter into the DC input port, and the other end into the power supply jack.

In normal condition, use an external power adapter and a battery. Use the battery only in the case that the electricity fails and the external power adapter is unavailable. If the battery level is low, the communication may be affected. It is recommended that you charge the battery for 15 minutes before making or receiving calls.

### Installing the Indoor Antenna

- 1 Make sure that the FWT is switched off.
- 2 Align the indoor antenna with the antenna port on the FWT host in the correct direction, and

then screw the antenna. Make sure the connection is secure.

### Connecting the FWT to a PC

#### Note

- Switch the FWT off and then disconnect it from the power adapter before connecting.
- Use the data service suite provided by the manufacturer.

The FWT can be connected to a PC to provide data services. You can also maintain and debug the FWT on the PC. You need to purchase the data service suite. For details, consult your local agent.

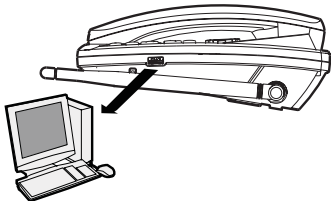

## ■ Mounting the FWT

### Mounting the FWT

#### Horizontal Mounting

Place the FWT on a flat surface. Select a cool and ventilated site for the FWT to dissipate the heat.

#### Vertical Mounting

- 1 Pull out the handset retaining clip from the slot and turn it around. Then push it back so that the handset will not fall down when FWT is placed vertically.

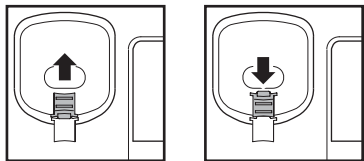

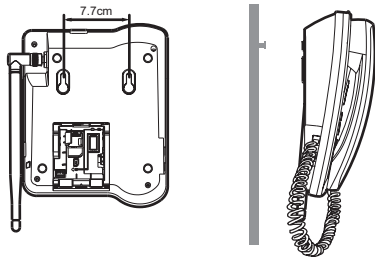

- 2 According to the distance between the two hooks (about 7.7cm), hammer two nails into the wall and leave a 3-mm space at the end of nails.

- 3 Snap the hooks to the nails.



### Validating

- 1 Press and hold  to power on your FWT.
- 2 The power icon  appears normally. The signal strength icon  appears normally.
- 3 If you can make a call, it indicates that the FWT is installed correctly.



# 3 Basic Operations

## Making or Answering Calls







### Making a Voice Call



- 1 Enter or edit a number in one of the following ways:
  - Enter a phone number through the keypad.
  - Select a number from **Call Log**.
  - Select a number from **Contacts**.

2 Press  to dial.

3 Press  to end the call.

### Answering or Rejecting a Call

- In standby mode, press , ,  or lift the handset to answer a call. Press  to end the call.
- In handsfree mode, press ,  or lift the handset to answer a call. Press  to end the call.

- Under headset mode, press ,  or lift the handset to answer a call. Press  to end a call.

## Operations During a Voice Call

During a voice call, you can select **Options** to perform the operations.

## Text Input

### Note

- Press \* key to switch between input methods.
- Press # key to enable or disable T9 method.
- Press 1 key to display the list of symbol.
- Press right soft key to delete the letter in front of the cursor.

## T9 Input Method

Press each key carrying the desired letter once, and then the predictive text scheme will present the avail-

## ■ Text Input

able words composed by the letters you have entered in the drop-down list.

### Traditional Input Method

---

When T9 input method is off, you can use the traditional input method. Repeatedly press the key that carries the letter to be entered when it appears on the screen.

### "123" Numeric Input Method

---

In a text editing screen, press and hold the character/number keys to enter corresponding numeric characters.

You can also press successively the \* key to switch to the "123" numeric input method, and enter corresponding numeric characters by pressing the character/number keys.

### Symbol Input Method

---

Your FWT provides an independent symbol input method.

For example, to enter ":" with the symbol input method, you can just press the scroll keys to select

":" from the symbol list and then press  .

### Inputting Different Languages

---

In a text editing screen, select **Options>Input language** to set the language for the text.

# 4 Contacts

## Making Calls from Contacts

- 1 In the **Contacts** screen, select **Phone** or **SIM**.
- 2 Select a contact and select **Options > Voice call**. Alternatively, you can select **Edit before call** to edit the number before making the call.

## Searching for a Contact



- 1 In the **Contacts** screen, select **Phone** or **SIM**.
- 2 Select **Options > Search**.
- 3 Select **Options > Search**, and then enter the contact name. The contact will be displayed.

In the **Phone** or **SIM** screen, enter a string contained in the contact name. Then the contacts whose names contain this string are displayed.

## Groups

### Adding/Deleting Group Members

---

- 1 In the **Contacts** screen, select **Groups**.
- 2 Select a group and press  to view the details.
- 3 Select **Options > Add**. Select a contact and press . The member you add will be displayed in the group member list.

To delete a group member, select a member from the group member list, and then select **Options > Delete**.

### Managing a Group

---

- 1 In the **Contacts** screen, select **Groups**.
- 2 Select a group and select **Options** for the following options.
  - **Details**: view the details of a group
  - **Rename**: change the name of a group

## ■ Other Operations

- **Create message:** send a text message to all members of a group
- **Delete:** delete a group and all members of the group

### Note

You cannot rename or delete any group preset in your FWT.

## Other Operations

In the **Contacts** screen, select **Phone** or **SIM** . Then select **Options** for the following options.

- **Details:** view the details of a contact
- **Edit before call:** edit the number before making a call
- **Create message:** send a message to the selected contact
- **New:** create a new contact
- **Voice call:** make a voice call
- **Search:** enter the contact name you are searching for
- **Copy to SIM/Copy to phone:** copy one or more contacts from your FWT to the SIM card or from your SIM card to the FWT

- **Copy Marked To Phone/Copy Marked To SIM:** copy the marked contacts to the FWT or to the SIM card
- **Speed Dial Number:** assign often-used numbers to speed dialing keys "2" to "9"
- **Delete:** delete the selected contact
- **Mark/Unmark:** mark/unmark a record or all records in your FWT and SIM card
- **Settings:** sort the contacts in the FWT and the SIM card or to set an alert before saving

In **Contacts** screen, select one of the following options.

- **Phone:** view the contacts in the FWT
- **SIM:** view the contacts in the SIM card
- **Groups:** view the groups of the contacts
- **Copy all:** copy all the contacts from your FWT to the SIM card or from your SIM card to the FWT
- **Delete all:** delete all the contacts from your FWT or from your SIM card
- **Memory status:** view the memory status of both your FWT and SIM card

## Text Messages

The maximum number of English letters in a single text message is 160. If the characters you entered exceed this limit, the text is divided into two or more continuous messages when it is sent.

### Creating a Text Message

- 1 Select **Messages > Write SMS** from the menu .
- 2 In the message editing screen, select **Options**:
  - **Send**: send the message
  - **Insert number**: insert a phone number saved in the FWT or the SIM card
  - **Common phrases**: speed up the text entry
  - **T9 Switch**: enable or disable T9 input method
  - **Input mode**: select the input method
  - **Input language**: select an input language
- 3 After editing, press  to access **Edit numbers**.

- Enter the phone number, and then press  to send the message.
- Select **Options > Groups** or **Contacts** to choose a number and send the message.
- Select **Options > Save to drafts** to save the message.

### SMS Mailboxes

#### Inbox

You can save the received messages in **Inbox**.



a read message in the SIM card memory



an unread message in the SIM card memory



a read message in the FWT memory



an unread message in the FWT memory





a message report

- 1 Select **Messages > Inbox** to view the messages and then press  to view the details.

## ■ Text Messages

### 2 Reply or call back.

- Press  to reply with a text message.
- Press  to call back by a voice call.

### 3 select **Options** for the following operations.

- **Reply:** reply the message
- **Forward:** forward the message
- **Edit before call:** edit the number
- **Save number:** save the numbers retrieved from an SMS to the FWT or SIM memory or an existing entry in the contacts
- **Delete:** delete the message

### Drafts

The **Draft** box is used to store the messages that you save and that fail to be sent.



a text message saved to the FWT.



a text message saved to the SIM card.

### Sent

The **Sent** box is used to store the messages that are sent.





a text message that are sent and saved to the FWT.



a text message that are sent and saved to the SIM card.

**1** Select **Messages > Sent** to select a message and to view the details.

**2** Forward or make a call.

- Press  to forward a text message.
- Press  to make a voice call.

## SMS Settings

**1** Select **Messages > Settings** on the menu.

**2** Set the parameters related to messages:

- **Message center:** You can set your FWT to retrieve the message center number from the SIM card or the FWT. If you delete the information by accident, contact your service provider.
- **Valid period:** The time within which a message can be kept in the message center after it is sent.
- **Auto save:** You can set that the message is saved automatically to **Sent** after it is sent.
- **Save to:** To set the position for saving messages.
- **Status report:** You can set it to **On** or **Off**. If you set it to **On**, the network send you the report on whether the message reaches the recipient.
- **Concatenated SMS:** You can set it to **On** or **Off**. If you set it to **Off**, you cannot edit and send messages longer than the limit of a single SMS.

## Voice Mail Number

You need to apply for the voice mail services from your network operator. After setting the correct number provided by your network operator, after press

and hold the **1** key in standby mode, the FWT dials the voice mail number automatically.

You can select **Messages > Settings > Voice Mail number** to set the number.

## Common Phrases

Your FWT is preset with some commonly used phrases for automatical replying and sending messages when you are answering a call.

You can select **Messages > Settings > Common phrases** to edit the phrases.

## Delete All

You can select **Messages > Delete all** to delete the messages in **Inbox**, **Sent** or **Drafts**.

# 6 Call Log

The last dialed calls, received calls and missed calls are saved automatically.

## Making Calls from Call Log

- 1 Select **Call Log** and then press the up/down scroll key to switch between **Missed**, **Received** and **Dialed**.
- 2 Select a record. Press  to make a voice call.
- 3 Select **Options** for the following options.
  - **Edit before call**: edit the number before making a call
  - **Create Message**: send a SMS
  - **Save number**: save the number of the selected record to the FWT, the SIM card, or an existing contact
  - **Voice Call**: make a voice call
  - **Details**: view the details of the selected record
  - **Delete**: delete the selected record

- **Mark/Unmark**: mark/unmark a record or all records

## Other Operations

### Calls Status

---

Select **Call Log > Calls status** to display the information about voice calls, and data services. In the voice call, and data screen, you can select **Reset** to clear all records.

### Delete All

---

Select **Call Log > Delete all** to delete the records of **All calls**, **Missed**, **Received**, or **Dialed**.



## Alarms

### Setting Alarm Clocks

---

Select an alarm. Press , and then you can set it.

### Prompt Interface for an Alarm

---

When it is time for an alarm clock to ring, the tone sounds and a prompt is displayed. Press any key to stop it, or select snooze or stop the prompt.

If your FWT is powered off, the alarm can still ring. When it rings, you can choose to power on the FWT.

### Stopping the Alarm Clock

---

Select an alarm clock from the list, and press the left soft key to deactivate it.

## Calendar

Select **Tools > Calendar** and select **Options**. You can perform the **Go to...** operation to go to a certain date directly from the month view screen.

## Calculator

Select **Tools > Calculator** on the main menu.

- Press the numeric keys to enter the figures.
- Press the scroll key to enter the operators.
- Press the left soft key to clear.
- Press the right soft key to exit **Calculator**.
- Press the # key to enter a radix point.
- Press  to enter an equal mark.

## World Time

Select **Tools > World Time** on the main menu.

You can view the time of important cities around the world. To switch among the time zones, press the left/right scroll key.

If the daylight saving time (DST) is used in your city, you need to set the FWT to DST. Then, you can get the right local time. To set the FWT to DST, switch to the desired time zone and then select **Options > Set Time Zone**.

# 8 Profiles

## Selecting a Profile

- 1 In the **Profiles** screen, select a profile.
- 2 Activate the selected profile.
  - Press  to activate it.
  - Select **Options** and select **On** to activate it.

## Editing a Profile

- 1 In the **Profiles** screen, select a profile.
- 2 Select **Options** and select **Edit** to set it.
  - **Voice call tone:** Select a ring tone for incoming calls.
  - **Message tone:** Select a message tone.
  - **Tone volume:** Adjust the volume of rings.
  - **Key tone volume:** Adjust the volume of keys.

- **Prompt tone volume:** Adjust the volume of prompts.
- **On-off tone:** Activate or deactivate the power-on and power-off tones.

### Note

- You can select a profile, and then select **Options** and select **Rename** to change the name of the profile.
- You cannot rename any profile preset in your FWT.

# 9 Settings

## Note

Please use an external power adapter and a battery together when you set the FWT.

## Phone settings

In the **Settings** screen, select **Phone settings**.

- **Phone Language:** Select a language. You can also select **Auto** to set it to be the same as the language that is used in your SIM card.
- **Input Language:** Set the language used to enter text.
- **Date and Time:** Change the system time for the FWT.
- **Date Format:** Change the display format of the date.
- **Shortcuts:** Assign the frequently used functions to the keys as shortcut keys.
- **Keypad lock period:** After enabling the auto keypad lock function, you can set the keypad lock period. If there is no operation on the FWT within a preset period of time, the keypad is locked automatically. You can press the \* key, then press  to unlock the keypad.

## Note

If the FWT is not used for a long time with no adapter or battery, you may need to set the time after switching the FWT on.

## Display Settings

In the **Settings** screen, select **Display Settings**.

- **Contrast:** Set the contrast level of the display.
- **Backlight time:** Set the delay time of backlight.
- **Greeting message:** Enter a greeting message that appears on the screen when you power on your FWT.

## Call Settings

### Minute Alert

---

If the function is activated, your FWT notifies you of the call duration by giving an alert several seconds before the end of each minute.

### Auto Dial

---

If the function is activated, the number you key in is dialed automatically at the time you set.

### Call Forwarding

---

When you can not to answer the phone or you want to forward a call, you can use this function.

## ■ Network

### Call Barring

---

You can restrict and allow all outgoing calls by activating this function.

### Call Waiting

---

When you are in a conversation, you can answer a third call by activating this function.

The function is network-dependent. For more information, consult your service provider.

### Calling ID

---

This function allows you to select whether to display your number on the phone of the party who calls you.

The function is network-dependent. For more information, consult your service provider.

### Select Line

---

It is used to set the call line for your FWT. Two options are available: **Line 1** and **Line 2**.

### My Number

---

With this function, you can save your own numbers on the SIM card. You can select **Options** to edit or delete the records.

### Call Barring Password

---

This function is used to change the password for call barring. Select **Call barring password** from the **Call settings** screen. Now you can change the call barring password.

#### Note

The old call barring password is provided by your network operator if it is the first time for you to change the password.

## Network

You can change the settings for the network. Select **Settings > Network** for following options: **Mode**, **Select network**.

## Security

You can change settings related to the FWT security. Select **Security** from **Settings**, and select the following security setting items:

### Reset

---

This option is used to reset user configurations of the FWT settings to the factory settings.

### Password lock

---

This option is used to enable or disable **Phone lock** and **PIN lock**.

### Change password

---

- 1 Select **Security > Change password**.
- 2 Select one item.
- 3 Enter the old password (The initial phone password is 0000.)
- 4 Enter a new password.

- 5 Enter the new password again to confirm.

#### Note

- To modify the PIN code, you must set **PIN lock** to **On** first.
- If you enter the wrong PIN or PIN2 for three times, the SIM card is locked. You need the PUK or PUK2 code to unlock the SIM card. If you enter the wrong PUK or PUK2 code for 10 times in total, the SIM card is locked permanently.
- The PUK or PUK2 code is delivered with the SIM card. If you do not receive the code or forget it, contact your service provider.

# 10 Warnings and Precautions

To use the FWT correctly and safely, read the following cautions and let your children know these before using the FWT.

## Basic Cautions

- According to the packing list, check items in the package box to make sure that they are complete and undamaged.
- Before installing and using the FWT, read this user guide carefully

## Electronic Device

Power off your FWT when it is close to high-precision electronic devices. The FWT may affect the performance of these devices.

Such devices include hearing aids, pacemakers, fire alarm systems, automatic gates, and other automatic-control devices. If you are using an electronic medical device, consult the device manufacturer and confirm whether the radio waves affect the operation of the electronic device.

## Hospital

Pay attention to the following points in hospitals or health care facilities:

- Do not take your FWT into the operating room (OR), intensive care unit (ICU), or coronary care unit (CCU).
- Power off your FWT when it is close to medical devices.
- Observe any instructions wherever the use of wireless device is prohibited.

## Traffic Safety

- Do not use your FWT while driving. Secure the FWT on its holder. Do not place the FWT on the seat or other places where it can get loose in a sudden stop or collision.
- Observe the rules and regulations of airline companies. Power off your FWT before boarding an aircraft.

## Operating Environment

- Do not place magnetic storage media such as magnetic cards and floppy disks near the FWT. Radiation from the FWT may erase the information stored on them.
- Do not put your FWT, battery, or other accessories in containers with strong magnetic field, such as the induction cooker and microwave oven. Otherwise, circuit failure, fire, or explosion may result.
- Do not place or use the FWT, the battery or the power adapter near any heat sources such as fire or a heater, or places with flammable gases; or areas with electrical appliances that give out heat. Otherwise, it will cause fire, explosion and breakdown of the FWT.
- Because the FWT needs to eliminate heat during working, put the FWT and the power supply in a ventilated and shadowy place. Never airtight the FWT or put something on it or place it near water, fire as well as inflammable and explosive materials.
- Because the FWT contains precision devices, you should put it in a dry place and away from moist materials.
- Before cleaning the FWT, please power off the FWT, and then disconnect the power supply and take out the battery. Before moving the FWT, please disconnect the external power supply.
- Do not subject your FWT, battery, and power adapter to serious collision or shock. Otherwise, battery leakage, FWT malfunction, overheating, fire, or explosion may result.
- Do not place sharp metal objects such as pins near the earpiece. The earpiece may attract these objects and hurt you when you are using the FWT.
- Do not place the FWT in the area over the air bag or in the air bag deployment area. Otherwise, the FWT may hurt you owing to the strong force when the air bag inflates.
- In raining and lightning, disconnect the power adapter from external power supply and power off the FWT. In this case, if the outdoor antenna is used, do not touch the FWT and antenna.
- Put your FWT, battery, and power adapter in places beyond the reach of children. Do not allow children to use the FWT, battery, or power adapter without guidance.

- Do not touch the antenna when a call is going on. Touching the antenna may affect call quality and cause the FWT to operate at a power level higher than needed.
  - The network signal condition will directly affect the quality and stability of the call. Consequently, you should place the FWT in a place where it can receive network signal well. Do not put FWT in a building with an iron or metal roof. The distance between FWT and other metal materials (such as metal brackets or metal doors and windows) should be greater than 25 cm and the distance between FWTs should be greater than 30 cm.
  - Do not open the chassis in any case and the device should be maintained by a qualified maintenance department.
  - Without permission, you are not allowed to modify the architecture and security design of FWT. You must bear any consequence resulted from the operation without permission.
  - Your FWT is designed to conform to the authoritative international radio frequency (RF) specifications. Use FWT accessories approved by Huawei only.
  - The antenna(s) used for this transmitter must be installed to provide a separation distance of at least 20cm from all persons.
  - Please observe the national local regulations in the location where product is to be used. This product may be restricted for use in some or all countries of European Union.
- Do not dispose of the battery in fire. Otherwise, the battery may ignite or explode.
  - When installing the battery on your FWT, do not push the battery by force lest battery fluid leak out or the battery crack.
  - Do not connect two poles of the battery with metallic materials such as cables.
  - Do not disassemble the battery or solder the battery poles. Otherwise, fluid leakage, overheating, fire, or explosion may result.
  - If there is battery leakage, smoke, or strange smell, stop using the battery and keep it away from open flame to avoid fire or explosion.
  - Disconnect the power adapter and take out the battery when the FWT is not used for a long time.
  - Do select its self-contained complete battery and power adapter; otherwise, the FWT may be spoiled. Huawei Technologies Co., Ltd is not responsible for any consequences caused by using non-standard batteries or power supplies. Dispose of used batteries according to the instructions.
  - Dispose of the battery according to local laws or regulations.

### Power Adapter

- Use AC power as specified for the power adapter. Any violation of this rule may result in fire or malfunction of the power adapter.
- Do not short-circuit the power adapter. Short-circuiting the power adapter may cause fire or malfunction of the power adapter.
- Remove the dust on the power plug regularly.
- Do not use worn-out power cords. Otherwise, electric shock, short-circuiting of the power adapter, or fire may result.
- Do not put the power adapter near the container filled with liquid such as water. If the liquid comes into the power adapter, electrical leakage or other faults may result.
- If the liquid such as water comes into the power adapter accidentally, remove the plug of the power adapter from the socket immediately.

### Emergency Call

You can use your FWT for emergency calls. However, connections in all conditions cannot be guaranteed. You should never rely solely on the FWT for essential communications.

### Battery

- If the battery fluid gets into eyes, do not rub them. Wash with clean water and seek medical assistance immediately.
- If the battery fluid contacts skin or cloth, wash with clean water immediately to avoid irritation to the skin.



- Disconnect the power adapter from the socket before cleaning or maintaining it. Otherwise, electric shock or short-circuiting of the battery or power adapter may result.
- Ensure the plug of the power adapter is properly inserted into the power socket when charging the battery. Improper insertion may result in electric shock, fire, or explosion.
- Do not place any heavy object on the power cord of the power adapter. Do not damage, change, or pluck the power cord.

### Using the USB Cable

When using the USB cable, observe the following requirements. Otherwise, the FWT or PC may fail.

- When the USB cable is used to connect the FWT to a PC, connect the USB cable with the FWT first.
- When the FWT communicates with a PC, do not disconnect the USB cable with the FWT, or the PC may fail.
- When disconnecting the USB cable, disconnect it from the PC first.

### Environmental Protection

Please abide by the local laws in disposing of the package materials of your FWT, consumed batteries and used FWT, and try to recycle them.

### Regulatory information

The following approvals and notices apply in specific regions as noted.

## EU Declaration of Conformity

according to the Radio Equipment and Telecommunications Terminal Equipment Directive 1999/5/EC

For the following equipment

Product: Fixed Wireless Terminal

Type Designation/Trademark: Neo 3000/VODAFONE

Manufacturer's Name: Huawei Technologies Co.,Ltd.

Manufacturer's Address: Bantian, Longgang District, Shenzhen, 518129, Guangdong, P. R. China.

is herewith confirmed to comply with the requirements set out in the Council Directive 1999/5/EC for radio equipment and telecommunications terminal equipment. For the evaluation of the compliance with this Directive, the following standards were applied:

Safety: EN 60950-1:2006

Health: EN 50383:2002; EN 50385:2002;

EMC: EN 301 489-1 V1.6.1; EN 301 489-24 V1.3.1; EN 301 489-7 1.3.1;

Radio: EN 301 908-1 V3.2.1: 2007; EN 301 908-2 V3.2.1; EN 301 511 V9.0.2;

Responsible for making this declaration is the: Manufacturer.

Version: V100R001\_01 Part Number: 31018972