



Block Nuisance Calls

## Quick Set-up and User Guide



### BT1700

Digital Cordless Phone with Answer Machine

# Important – please read first

---

- Only use the line cord, power supply (item code: 066773) and rechargeable batteries supplied with your phone.
- Make sure that the power supply is connected to a known working socket.
- Connect your phone to the power supply and allow the batteries to charge for 16 hours before connecting the line cord to your telephone socket.
- To make sure you get the best range and reception from your handset, avoid interference by placing the base unit away from large metal objects such as fridge freezers and microwave ovens or electronic products such as computers and TVs.

# Check box contents



Handset



Base

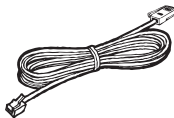

Telephone line cord  
(pre-installed)

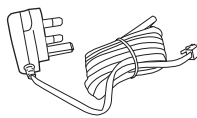

Mains power adaptor  
(item code 066773)

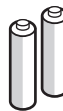

2x AAA NiMH 500mAh  
rechargeable batteries  
(already in handset)

## Contents for each additional handset (multipacks only)



Handset



Charger

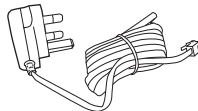

Mains power adaptor  
(item code 066773)



2x AAA NiMH 500mAh  
rechargeable batteries  
(already in handset)

### ! IMPORTANT

Only use the mains power adaptors, cables and rechargeable batteries supplied in this box, or this product may not work. Any replacement rechargeable batteries must be of the same type. BT accepts no responsibility for damage caused to your BT1700 by using any other type of batteries.

# Quick set-up guide

## Where to put your phone

- Place the base within 3 metres of a mains power socket and 1.8 metres of a phone socket so the cables will reach.
- Don't place the phone or base in a bathroom or other humid area.
- The product works by sending radio signals between the handset and base. The strength of the signal depends on where you position the base. Putting it as high as possible can help give you the best signal.

## IMPORTANT

- The base station should be plugged into the mains power socket all the time.

## 1 Plug in

1. Plug the mains power adaptor into the base, with the cable clipped in the groove provided.
2. Plug the other end of the power adaptor into the wall power socket and switch on.

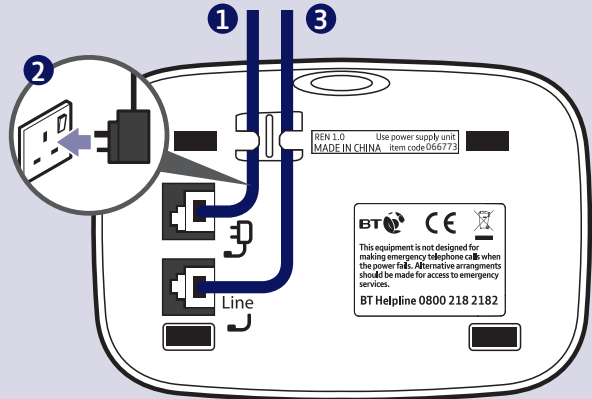

3. The telephone line cord is already fitted, plug the other end into the wall socket.

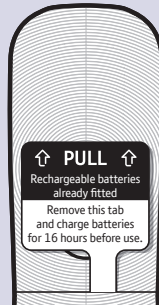

## 2 Activate the batteries

1. Activate the batteries by pulling the plastic tab away from the back of the handset.



2. The handset will check for a link with the base station. Once found, the screen will show the handset name i.e. HANDSET 1.



Press the Left option button  on the handset to set up date and time. You can press the Right option button  to skip any further options until setup is complete (you can always set these up later).

### Talk/Standby time

Under ideal conditions, the handset batteries should give up to 10 hours talk time or 100 hours standby on a single charge.

Please note that new Ni-MH rechargeable batteries don't reach full capacity until they've been in normal use for several days.

### Battery low warning

The  icon will flash, you'll hear a warning beep every minute, to indicate that you need to recharge your handset before you can use it.

If the battery charge completely runs out, you must recharge the handset batteries before you can use the handset. Place the handset on the base or charger to charge.

When a handset is charging from a low charge, the display shows four characters scrolling in a circle on the bottom line of display.

## 6 Quick set-up guide

### Battery performance

- To keep the batteries in the best condition, leave the handset off the base for a few hours at a time.
- Running the batteries right down at least once a week will help them last as long as possible.
- After charging your handset for the first time, subsequent charging time for the batteries is approximately 8 hours.
- The charge capacity of rechargeable batteries will go down over time, which will reduce the talk and standby time. Eventually they'll need replacing. For details on how to get replacement batteries, call the helpline on 0800 218 2182\*.

3. Once set-up is complete your handset will display the handset name, place the handset on the base to charge.
4. After 16 hours, plug the phone line cord into the phone wall socket.



### IMPORTANT

Charge the handset batteries for 16 hours or your phone might not work.

## Set up your additional handsets (multipacks only)

1. For additional handsets and chargers: plug the mains power adaptor into the underside of the charger and plug the other end into the mains wall socket and switch on the power.

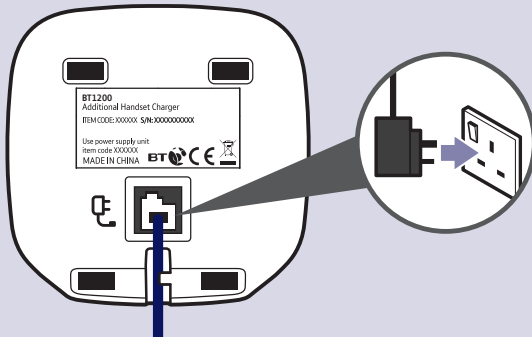

2. Activate the batteries as explained on page 5.
3. Place the handset on the charger to charge for 16 hours.

**!** If you ever need to remove the batteries, slide open the battery compartment cover then gently ease the batteries out.

## Using your BT1700 on a line with broadband?

To avoid problems with your broadband or noise on your phone line, you might need to plug your telephone line cord into the wall socket via a microfilter (not supplied).

If your main phone socket has a **single** socket, you **do** need to use microfilters, like this:

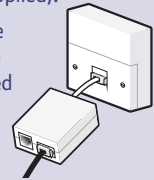

You'll need a microfilter for every phone socket where you've got equipment plugged in – up to a maximum of four per line – including alarm systems and digital TV boxes.

You can get BT ADSL micro filters from [bt.com/shop](http://bt.com/shop)

You **don't** need to use microfilters if your main phone socket has **two separate** sockets, like these:

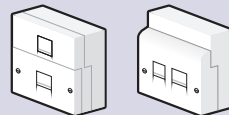

If you cannot find the answer to your problem in this user guide, then please call our free Helpline on 0800 218 2182\*. Our dedicated advisors are more likely to be able to help you than the retailer where you made your purchase.

### **3** Go!

Your BT1700 is now ready for you to use

- For help setting the date and time, go to page 47.
- For instructions on making a call, go to page 19.
- For help personalising your phone's settings, go to page 42.
- For instructions on using the answer machine, go to page 32.

Or, you may find the answer in the Help section on page 52 or see our online frequently asked questions at **[bt.com/producthelp](http://bt.com/producthelp)**

Alternatively, call the Helpline on 0800 218 2182\*.

\* Calls made from within the UK mainland network are free. Mobile and international call costs may vary.



# In this guide

## Getting to know your phone

Handset buttons .....	12
Handset display and icons .....	13
Finding your way around your phone.....	14
Menu map.....	15
Base.....	18

## Using the phone

Make an external call .....	19
Preparatory dialling .....	19
End a call.....	19
Switch the handset on or off.....	19
Receive a call.....	20
Call Waiting .....	20
Mute.....	21
Incoming speech volume.....	21
Redial .....	21
Voicemail (1571) .....	22
Turn the handset ringer on or off.....	22
Finding handset (paging) .....	22

## Phonebook

Store entry in phonebook.....	23
Dial entry in phonebook.....	23
Character map .....	24
View/dial entry in phonebook.....	24
Edit entry in phonebook.....	25
Delete entry in phonebook.....	25
Delete all entries in phonebook.....	26
View the phonebook memory status..	26

## Call Blocking

Block incoming call number in your Calls list .....	27
Turn call blocking on to enable.....	27
blacklist	
Add, view, edit or delete a number in your blacklist .....	28
Block incoming call by call type .....	28

## Caller Display and the Calls list

Caller Display.....	29
Calls list.....	29

## 10 In this guide

---

Missed call notification.....	30	Delete all old (played) messages .....	36
View/dial an entry in the Calls list.....	30	Using the answer machine from the base .....	37
Save a Calls list entry to your contacts .....	30	Switch the answer machine on or off..	37
Delete an entry in the Calls list .....	31	Message playback using the base.....	37
Delete the entire Calls list .....	31	Delete all old (played) messages .....	38
<b>Answer machine</b>		Remote access.....	39
Using the answer machine from the handset.....	32	Change the remote access PIN .....	39
Switch the answer machine on or off..	32	Turn remote access on/off .....	39
Outgoing messages.....	32	If you forget to switch on your answer machine.....	40
Record your own outgoing message..	33	Operating your answer machine remotely .....	40
Play the current outgoing message ...	33		
Set the answer mode (Answer & Record or Answer Only) ....	34	<b>Settings</b>	
Set the answer delay .....	34	Set the handset ringtone for external or internal calls .....	42
Set the maximum message length.....	35	Set the handset ringer volume .....	42
Call screening .....	35	Turn the handset tones on or off .....	43
Message playback using the handset.....	36	Change the handset name .....	44
		Change the call settings .....	44

Set the base ringtone .....44  
 Set the base ringer volume .....45  
 Set a PBX access code .....45  
 Change the system PIN.....46  
 Reset the handset or base settings ....46

**Clock/Alarm**

Set the time and date.....47  
 Set an alarm .....47  
 Stopping the alarm when it goes off .. 48

**Using additional handsets**

Register an additional handset.....49  
 De-register a handset .....50  
 Make an internal call  
 between handsets.....50  
 Transfer a call.....50  
 Hold a 3-way call.....51

**Help** .....52

**General information**

Safety information .....56  
 Cleaning.....57  
 Environmental.....57  
 How to recycle your equipment .....57  
 Guarantee .....58  
 Technical information.....59  
 Connecting to a switchboard .....59  
 Recall (R).....59  
 R&TTE .....59  
 Declaration of Conformance .....59

# Getting to know your phone

## Handset buttons

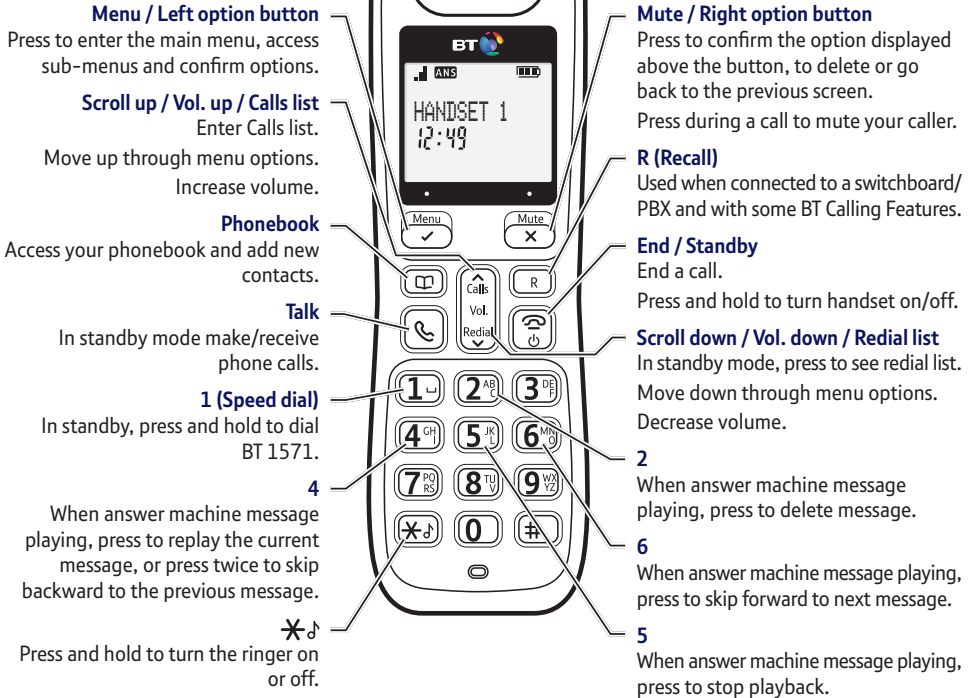

## Handset display and icons

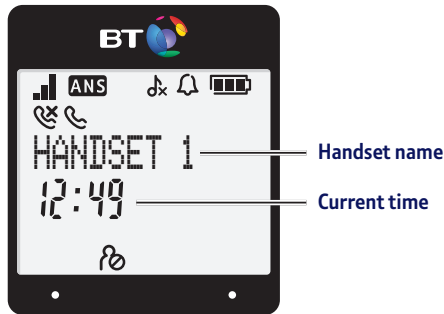



 Handset battery charge status.  
Scrolls when the handset is charging.

 Flashes empty when the battery needs recharging.

 Signal strength (from handset to base).

 Missed call in the Calls list<sup>†</sup>.

 On – line in use.  
Flashing – there's an incoming call.

 On – answer machine is on.  
Flashing – new messages received.

 Call block mode or call block type is switched on.

 Handset ringer is switched off.







 On – alarm is set.  
Flashing – alarm time has been reached.

<sup>†</sup> For full details of who has called you please make sure you have subscribed to Caller Display from your network provider. A fee may be payable. **Find out more at [bt.com/callingfeatures](http://bt.com/callingfeatures)**

## Finding your way around your phone

Your BT1700 has an easy to use menu system. Each menu has a list of options, which you can see on the menu map on the next page.

### When the handset is switched on and at the home screen:

1. Select **Menu** by pressing the Left option button  to open the main menu.
2. Use the  or  button to scroll through the available menu options.
3. When the menu you want is displayed, press the Left option button .
4. Use the  or  button to scroll through the available sub menu options.

When the sub menu you want is displayed, press the Left option button . Select **Back** by pressing the Right option button .

To exit a menu and return to the home screen, press .

If no buttons are pressed for 30 seconds, the handset returns to the home screen automatically.



## Menu map

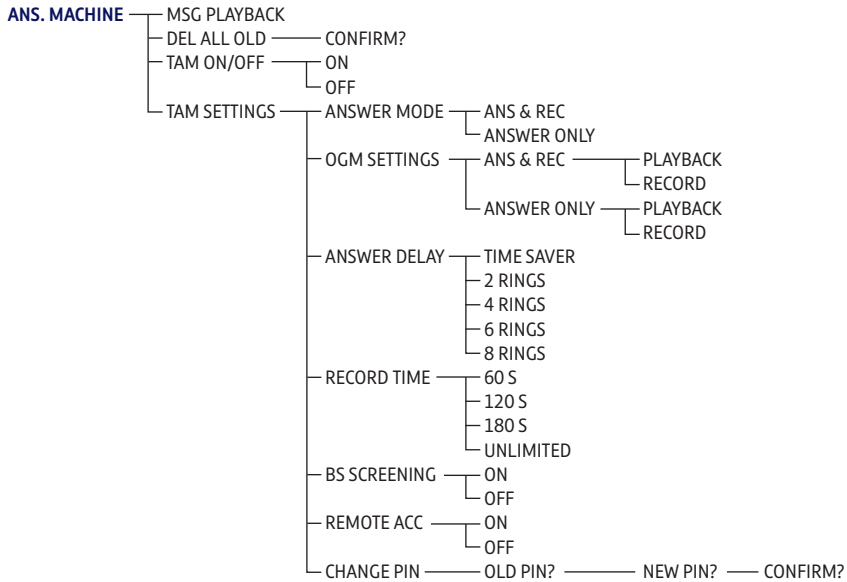

continued on next page...

## 16 Getting to know your phone

---

### Menu map continued

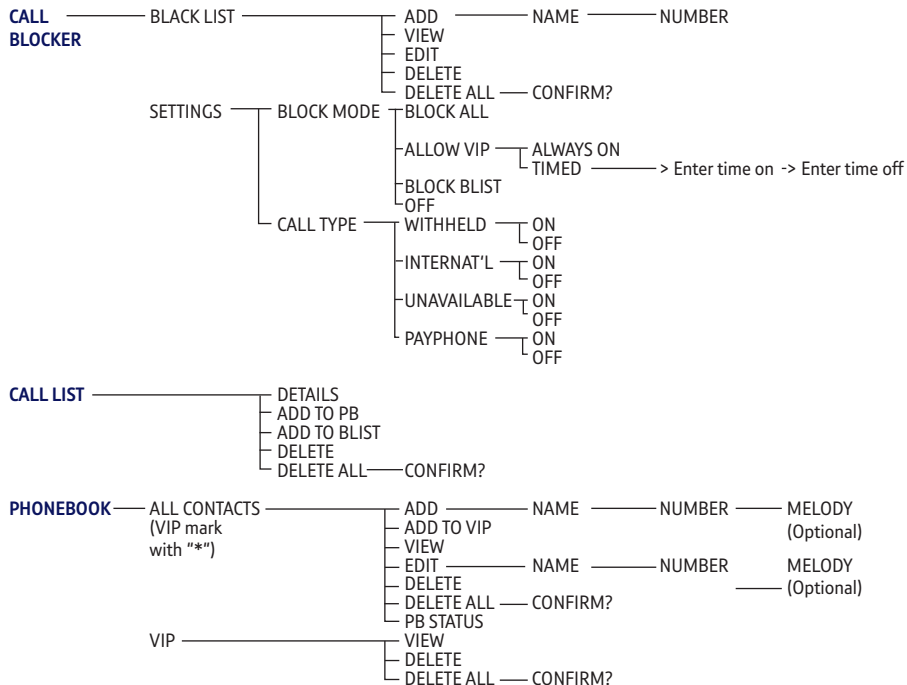



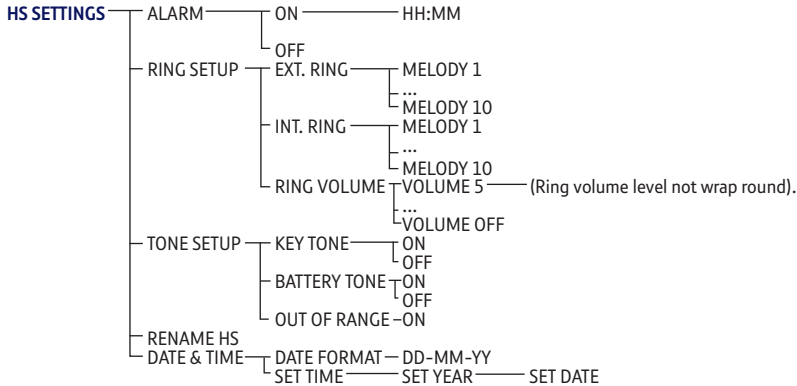
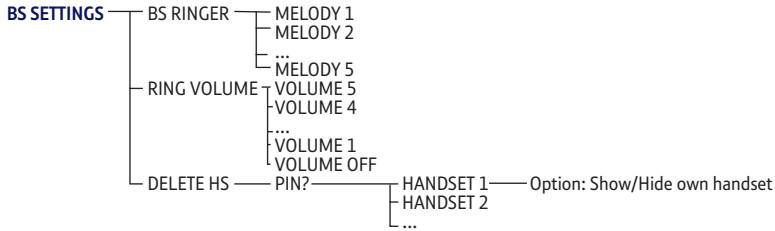

**REGISTRATION** — PIN?

**DEFAULT** — PIN? — CONFIRM?

## Base

### Find

Press to ring all registered handsets, helpful for finding a missing handset, see page 22. Also used during the registration process, see page 49.

### Answer on/off

Press to turn the answer machine on or off. When set to On, the text 'On' will light up on the button.

### Delete

Press once to delete the message during playback. In idle mode, press to delete all old messages.

### Stop

Press to stop message playback.

### Skip

During playback, press once to skip back to the start of the current message. Press twice to skip back to the start of the previous message.

### Skip

During playback, press to skip forward to the start of the next message.

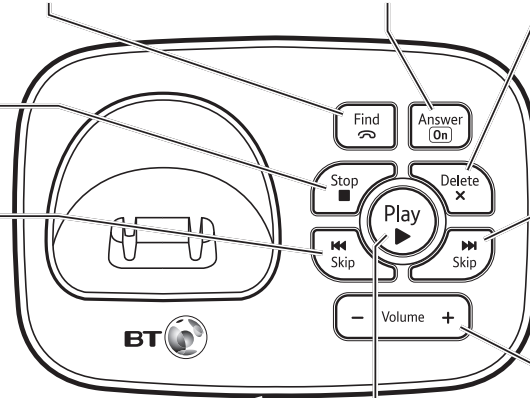

### In use / Charging light

Blue light is on and flashes when phone rings or the handset is in use.

### Play

Green light on the button flashes when there are new messages. Press to play messages.

### - Volume +



Decrease or increase the speaker volume during playback, the call screening volume during idle and the base ringer volume.

# Using the phone

## Make an external call

1. Press green .
2. When you hear the dial tone, enter the number.

## Preparatory dialling

1. Enter the number first. If you make a mistake select **Del.** by pressing the Right option button  to delete the last digit.
2. Press  to dial.

## End a call

1. Press red .

## To switch the handset off



1. Press and hold  until the handset turns off.

## To switch the handset on

1. Press and hold  until the handset turns on.

## Call timer

Your handset will automatically time your outgoing and incoming calls. The handset shows the length of time both during and for a few seconds after your call.

When dialling a number, \* is displayed as  and # is displayed as .

## Auto end

By default you can end a call just by putting the handset back in the base.

If you switch the phone off and on again, the phone will need to be charged for some time, before the true charge status can be recalculated by the phone and accurately displayed.

### Auto answer

By default, auto answer is set to On, so you can answer a call just by lifting the handset off the base.

If auto answer is set to Off, you'll need to lift the handset off the base and press  too. See page 44.

### Out of range warning

When the handset is out of range of the base, the display will show **OUT OF RANGE**, you will hear a warning tone. You need to move back within range of the base station.

If you move out of range when you're on a call, you'll lose your connection. The handset will automatically re-connect to the base when you move back within range.



### Receive a call

When you receive a call, the phone rings and the display shows **CALL** and . If you've got a caller display service, the display shows the caller's number if it's available or the caller's name if it matches an entry stored in your contacts list.



1. Lift the handset from the base or charger to accept the call. If the handset isn't on the base or charger, you'll need to press green .

### Call Waiting



If you've got a call waiting service and it is switched on, your phone will alert you to a second incoming call if you're already engaged on an external call.

1. You'll hear the call waiting tone and if you also have caller display the display will show the number of the caller, or the name if it matches an entry in your contacts.
2. Press  to answer the new call. Your first caller is put on hold.
3. Press  to toggle between the two callers.
4. Press  to hang up the current call.
5. If you hang up a current call, your phone will ring back to reconnect you to your original call if that caller is still connected.

## Mute

1. During a call, press . The display shows **SECRECY ON** and your caller can't hear you.
2. Press  to return to your caller.





## Incoming speech volume

1. Press  or  to increase or decrease the volume. The first press will present the Call volume screen so you can see the current volume level. Subsequent presses will change the volume, you will hear the volume level with each press.

During a call, you can adjust the handset incoming speech volume. There are five levels. The default setting is Level 3.

## Redial

Telephone numbers that you have called are saved in the Redial list. The Redial list holds up to 20 outgoing calls.

1. To redial a number, press .
2. Then press  or  to scroll to the entry you want and press  to dial the number.

If you get an incoming call while you're paging a handset, the incoming call takes priority.

If the handset ringer is switched off on a handset, it will be temporarily switched back on so the handset can be found.

Paging calls can't be answered by a handset.

### **Voicemail (BT 1571)**



1. If you have subscribed to BT Answer 1571 you can press and hold **1** to listen to your messages.

### **Turn the handset ringer on or off**

1. Press and hold **\*x\*** for 2 seconds to turn the handset ringer on or off. The display will briefly show RINGER ON or RINGER OFF before reverting to the home screen with the **dx** icon displayed if the ringer is off.

### **Find handset (Paging)**







You can ring a handset to help find it.





1. Press **Find**  on the base. All handsets registered to the base will ring and the screen will show PAGING.
2. To stop the ringing, press **Find**  on the base again or press **Find**  on any handset.

# Phonebook

You can store up to 50 names and numbers in your list of phonebook. Names can be up to 12 characters and numbers up to 24 digits.





## Store entry in phonebook (up to 50)

1. In idle mode, press . EMPTY is displayed if there are no numbers.
2. Press  to select ADD. Enter name using keypad and press .
3. Enter phone number and press  to save.
4. Press  to select ring melody, then  to save.



To save a number to your phonebook from the incoming Calls list, press , then scroll to the entry you want and press . Scroll to ADD TO FB (phonebook) and press . Enter a name using the keypad and press . Then follow steps 3 to 4 above.

If you have more than one handset registered to the base, your contacts are automatically updated to all handsets (up to 6 handsets).

## Dial entry in phonebook

1. In idle mode, press .
2. Scroll  or  to display the entry and press  to dial.

## Entering names

Use the keypad letters to enter names, e.g. to store Tom: Press  once to enter T. Press  three times to enter o. Press  once to enter m.

## Writing tips

To delete the last digit/character entered, select Del. by pressing the  button.

Press  to insert a space.

## To enter a pause in a phonebook number

When storing a number, press and hold  in the place where you want the pause.

## To enter a recall in a phonebook number

When storing a number, press and hold  in the place where you want the recall.

### Searching alphabetically

Press the relevant keypad button, e.g. to search for a contact beginning with S, press



four times, then scroll through the entries.

### Character map













1	SPACE _ 1
2	A B C 2
3	D E F 3
4	G H I 4
5	J K L 5
6	M N O 6
7	P Q R S 7
8	T U V 8
9	W X Y Z 9
0	0
*	* ? /   ( )

### View/dial entry in phonebook







1. From the home screen, press . The first entry will be displayed.
2. Press or to scroll through and view the entries.
3. To dial an entry, press when the entry is displayed.



### Edit entry in phonebook





1. From the home screen, press .
2. Press  or  to scroll to the entry you want to edit and select by pressing Left option .
3. Press  to display EDIT and press .
4. Edit the name using  to delete characters and use the keypad to enter new ones, then press .
5. Edit the number using  to delete numbers and use the keypad to enter new ones, then press .
6. Press  to select ring melody, then  to save.

### Delete entry in phonebook





1. From the home screen, press .
2. Press  or  to scroll to the entry you want to delete and select by pressing .
3. Press  until DELETE is displayed and press . You will hear a confirmation tone.

When you delete all phonebook entries they will be deleted on all the handsets you are using.

### Delete all entries in phonebook





1. From the home screen, press . The first entry will be displayed. Select by pressing .
2. Press  until DELETE ALL is displayed and press .
3. CONFIRM? is displayed, press  to confirm delete all. The display will show EMPTY and you will hear a confirmation tone.

### View the phonebook memory status







1. From the home screen, press . The first entry will be displayed. Select by pressing .
2. Press  until PB STATUS is displayed and press .
3. The display will show the total number of contacts stored and the total amount of contacts that can be stored, e.g. 05/50 USED.

# Call Blocking

## Block incoming call number in your Calls list†

1. Press , scroll to the entry and press . DETAILS is displayed.
2. Scroll to ADD TO BLIST (blacklist) and press .
3. Enter name using keypad, press . The number is displayed, press  to save. You will hear a confirmation tone.











## Turn call blocking on to enable blacklist

1. Press , scroll to CALL BLOCKER, and press .
2. Scroll to SETTINGS, press .
3. Scroll to BLOCK MODE and press .
4. Select BLOCK BLIST, press .
5. Scroll to ALWAYS ON, press . The  icon is displayed.







† Requires a subscription to a Caller Display service from your network provider. Charges may apply.

Note, the same phone number can't be saved in the blacklist and phonebook.

### Add, view, edit or delete a number in your blacklist

1. Press , scroll  to CALL BLOCKER, and press .
2. Scroll  to BLACK LIST, press .
3. Scroll  or  to number you want to view, edit or delete in your blacklist. Or go to step 4 to add a number to your blacklist.
4. Press , and scroll  or  to ADD, VIEW, EDIT, DELETE or DELETE ALL and press .
5. Follow the on-screen instructions.

### Block incoming call by call type†

1. Press , scroll  to CALL BLOCKER, and press .
2. Scroll to SETTINGS, press .
3. Scroll to CALL TYPE, press .
4. Scroll to the call type you want to block – WITHHELD, INTERNAT'L, UNAVAILABLE or PAYPHONE – and press . You'll hear a confirmation tone.

# Caller Display and the Calls list

## Caller Display

If you've subscribed to a Caller Display service, you'll be able to see your caller's number on your handset display (provided it's not withheld) before you answer a call. If your caller's name is stored in your contacts list and it matches the number calling, you'll see the caller's name on the display instead. If you haven't subscribed to a Caller Display service **Incoming call** will be displayed when you receive a call.

## Calls list

The Calls list holds up to 20 incoming (missed and answered) calls. The date and time of the call is also stored. If you haven't subscribed to a Caller Display service, no number will be displayed for incoming calls.

Calls are listed in chronological order with the most recently received/made call at the top of the list. When the list is full and a new call is received/made, the oldest entry will be deleted automatically. The Calls list can hold numbers up to 24 digits and names up to 12 characters.

You'll need to subscribe to your network provider's Caller Display service for this feature to work. You might have to pay a fee. For more information on BT Calling Features, go to [bt.com/callingfeatures](http://bt.com/callingfeatures)

For the caller's name to be displayed, make sure you've stored the full telephone number in your contacts list, including the dialling code.

There are some incoming calls where a number is not displayed and a network message is recorded instead:

**UNAVAILABLE** = number is unavailable

**WITHHELD** = number has been withheld

**INTERNATION** = international number

**OPERATOR** = call from the operator



**PAYPHONE** = call from a payphone



**RINGBACK** = a ringback call

## 30 Caller Display and the Calls list

### Calls list indicator

 = missed call

When the Calls list is open, press  to scroll from the newest call to the oldest, or press  to scroll from the oldest call to the newest.





If you need to edit the number or name, press  or  to move cursor left or right and **Del.** to delete unwanted digits/characters then use the keypad to enter new ones.

The other handset(s) must be in idle mode to work.









### Missed call notification

The number of missed calls will be shown e.g. 10 new calls. You can clear the notification by viewing the calls list on any handset registered to the base.







### View/dial an entry in the Calls list

1. Press . The most recent entry is at the top of the list. (If there are no entries EMPTY will be displayed.)
2. Press  or  to scroll through and view the list.
3. To dial an entry, when the entry you want is displayed, press .





### Save a Calls list entry to your phonebook

1. Press  then press  or  to scroll to the entry you want and select by pressing .
2. Scroll to **ADD TO PB**, press .
3. Enter name using keypad and press .
4. Enter phone number and press .
5. Press  to select ring melody, then .
6. If you have more than one handset registered to the base, they will be updated automatically.

### Delete an entry in the Calls list

1. Press , then press  or  to scroll to the entry you want to delete and select by pressing .
2. Press  until DELETE is displayed and press . You will hear a confirmation tone.

### Delete the entire Calls list

1. Press , then display any entry and select by pressing the  button.
2. Press  until DELETE ALL is displayed, then press . You will hear a confirmation tone.

# Answer Machine

You'll need to set the date and time (if you've not already done so) so that the answer machine can correctly announce when each message was received. To set the date and time manually, see page 47.

When the answer machine is switched On, the text 'On' will light up on the  button on the base.

## Answer & Record

The pre-recorded Answer & Record outgoing message that allows your caller to leave a message is, "Hello, your call cannot be taken at the moment, so please leave your message after the tone".







## Answer Only

The pre-record Answer Only outgoing message, where callers hear an announcement but can't leave a message, is "Hello, your call cannot be taken at the moment and you cannot leave a message, so please call later".

Your BT1700 can record up to 30 minutes of messages. You can operate your answer machine from: the handset, the base or remotely from any other Touchtone™ telephone.

## Using the answer machine from the handset

### Switch the answer machine on or off











1. Press , ANS. MACHINE is displayed, press .
2. Press  until TAM ON/OFF is displayed, press .
3. Press  or  to select ON or OFF then press  to save. TAM ON/OFF will be displayed.

### Outgoing messages







The outgoing message is the message a caller first hears when the answer machine picks up their call. There are two pre-recorded outgoing messages to choose from, one that allows callers to leave a message (Answer & Record) and one that simply answers the call (Answer Only) or you can record your own. The default is Answer & Record.



### Record your own outgoing message

1. Press , ANS. MACHINE is displayed, press .
2. Press  until TAM SETTINGS is displayed, press .
3. ANSWER MODE is displayed. Scroll  to OGM SETTINGS, press .
4. ANS & REC is displayed, or press  to select ANSWER ONLY and press .
5. Press  to display RECORD MESS. Follow the voice prompt to record your message and press  when you've finished. Your message will be played back to you. If you are not happy with it you can delete by pressing .

### Play the current outgoing message

1. Follow steps 1 to 3 in 'Record your own outgoing message' above.
2. Press  or  to display the outgoing message mode you want: ANS & REC or ANSWER ONLY and press .
3. Press  to display PLAYBACK and press  to hear the outgoing message. If the current outgoing message being played is your recorded message you can delete it if you want to by pressing .

When recording your Answer Only message, remember to let your caller know that they won't be able to leave a message.

Deleting your own recorded outgoing message will reinstate the pre-recorded outgoing message.





**Time saver**

When you ring in to access your answer machine remotely, if you have set Time saver as the answer delay and you have new messages it will answer after 4 rings. If you don't have new messages it will answer after 6 rings. This means you can hang up knowing that you have no new messages, saving you the time and the cost of the call.

**For compatibility with BT 1571 (or another voicemail service)**









Make sure the answer delay is set for your answer machine to answer before the voicemail service. Therefore, the answer delay should be less than on your voicemail service. For BT 1571 do not set the answer delay to more than 5 rings.

**Set the answer mode (Answer & Record or Answer Only)**

1. Follow steps 1 to 2 in 'Record your own outgoing message' on page 33.
2. ANSWER MODE is displayed, press .
3. Press  or  to display the outgoing message mode you want: ANS & REC or ANSWER ONLY and press . You will hear a confirmation tone.









**Set the answer delay**

The answer delay setting sets how many times the phone will ring before the answer machine takes the call. You can choose from 2–8 rings or Time saver. The default setting is 4 rings.

1. Press , ANS. MACHINE is displayed, press .
2. Press  until TAM SETTINGS is displayed, press .
3. Press  to display ANSWER DELAY and press .
4. Press  or  to display the number of rings you want (2–8 rings or Time saver) and press  to save your new setting.

## Set the maximum message length









You can set the maximum length that an answer machine message can be: 1 minute, 2 minutes, 3 minutes or unlimited. The default setting is 3 minutes.

1. Press , **ANS. MACHINE** is displayed, press .
2. Press  until **TAM SETTINGS** is displayed, press .
3. Press  to display **RECORD TIME** and press .
4. Press  or  to select the length you want and press  to save your new setting.



## Call screening

When call screening is turned on and the answer machine takes a call, you can listen to the caller leaving a message. You can then identify the caller and decide whether to take the call in person.

### Turn call screening on or off

1. Press , **ANS. MACHINE** is displayed, press .
2. Press  until **TAM SETTINGS** is displayed, press .
3. Press  until **BS SCREENING** is displayed, press .
4. Press  or  to display **ON** or **OFF** and press  to save your new setting.

The default setting is call screening On.

While screening, you can adjust the volume by pressing  or  on the handset or  on the base.

Each message is played back with the day, date and time it was received announced.

New (unplayed) messages are played first (oldest to most recent) and then old (played) messages (oldest to most recent).

If the memory is full, you can still playback your messages by pressing , however, the phone will alternately display TAM FULL and the handset name or date/time information depending on handset settings selected.



Message playback is stopped if you receive an incoming call.

## Using call screening





When the phone rings, wait for the answer machine to take the call. When the caller begins to leave a message, the display will show SCREENING? If you want to talk to the caller, press  to take the call. This will stop the recording if it's started.

## Message playback using the handset

When you receive new messages you will be notified by a message on the handset display and the  button on the base will flash: a fast flash indicates new (unplayed) messages.

1. Press , ANS. MACHINE is displayed, press .
2. MSG PLAYBACK and the number of new messages will be displayed, press . Your messages will now be played, with the most recent first.

## Delete all old (played) messages

1. Press , ANS. MACHINE is displayed, press .
2. Press  until DEL ALL OLD is displayed, press .
3. CONFIRM? is displayed, press  to confirm. You will hear a confirmation tone.

## Using the answer machine from the base

### Switch the answer machine on or off

Press  to toggle between On and Off. The setting is announced.

When the answer machine is On, the text 'On' will light up on the  button.

### Message playback using the base

Press . If you have messages they will be played, new (unplayed) messages first followed by old (played) messages.

During playback:

Press  to stop playback. The base will return to idle.

Press  to delete the message being played.

Press  to skip forward to the start of the next message.

Press  to skip back to the start of the current message.

You can't delete messages that you've not played yet.

Unless you delete a message, it's automatically saved.

To cancel deletion when you see the message  press .

### Memory full

If there is only 10 seconds of memory capacity left when a caller is leaving a message they will hear, "Please complete your message within 10 seconds." If a caller is still leaving a message when the memory expires they will hear, "Memory full. Thank you for calling", and the call will be ended.

If your answer machine memory becomes full and it is set to Answer and record it will automatically switch to Answer only mode. Once messages have been deleted and there is memory available again, the machine will revert to Answer and record mode (unless you have changed the mode yourself to Answer only using the handset menu).



You will need to delete messages before your answer machine will be able to record new ones. To delete all old (played) messages, see page 37 and opposite.

Press  twice to skip back to the start of the previous message.

Press  to increase or decrease the playback volume level.

At the end of playback the base will return to idle mode and messages will be renumbered to take into account any deleted messages.

### Delete all old (played) messages









1. In idle mode, press . The base will announce, "To delete all old messages, press Delete".
2. Press  within 3 seconds to delete all old messages. You will hear, "All old messages deleted." (If you don't press  within 3 seconds you will hear, "Messages saved").

## Remote access









With remote access you can operate your answer machine from any Touchtone™ phone, even if you forget to turn on your answer machine before you go out.

You need to set a remote access PIN first and then you will need to turn remote access On if you want to use this feature.

### Change the remote access PIN

1. Press , ANS. MACHINE is displayed, press .
2. Press  until TAM SETTINGS is displayed, press .
3. Press  until CHANGE PIN is displayed, press .
4. Enter your old 4 digit PIN and press .
5. Enter the new 4 digit PIN, press  and then enter the new PIN again and press . You will hear a confirmation tone.

### Turn remote access on or off

1. Press , ANS. MACHINE is displayed, press .
2. Press  until TAM SETTINGS is displayed, press .
3. Press  until REMOTE ACC is displayed, press .
4. Press  or  to display ON or OFF and press .





Default remote access PIN is 0000.

The default remote access setting is Off.

### **If you forget to switch on your answer machine**

1. Call your number from another phone and let it ring. After 20 rings the machine will switch on and answer your call.
2. Press \* and enter your 4 digit remote access PIN when prompted. Play back your messages as shown on the next page in, 'Operating your answer machine remotely'. If you do not choose to switch your answer machine On, it will switch off when the call is ended.

### **Operating you answer machine remotely**

1. Dial your phone number.
2. When you hear your outgoing message, press \* and enter your 4 digit remote access PIN.
3. Follow the voice prompts to:
  - 1  Replay current message
  - 2  Play all messages
  - 3  Delete a message during playback
  - 4  Skip back during playback. Press twice, to skip to the previous message
  - 5  Turn **Answer Machine** on/off





- 6<sup>MN</sup> Skip forward during playback
- 8<sup>TU</sup> Listen to current outgoing message
- 9<sup>WX</sup> Record new outgoing message
- 0 Play main menu options again
- # Switch between **Answer Only** and **Answer & Record**

# Settings

Choose from 5 handset ringtones. The default external ringtone is Melody 1 and the internal ringtone is Melody 2.











There are 5 handset ringer volume levels plus Ringer Off. The default setting is Level 3.

If you turn the ringer off, the  icon will be displayed on the home screen.









As a quick way to turn the handset ringer off, press and hold .

## Handset settings

### Set the handset ringtone for external or internal calls











1. Press , scroll  to HS SETTINGS and press .
2. ALARM is displayed, scroll to RING SETUP, press .
3. EXT. RING is displayed, press .  
Or, press  to display INT. RING and then press .
4. The current ringtone will be played.  
Press  or  to hear the different ringtones and press  to save your choice, you will hear a confirmation tone.

### Set the handset ringer volume

1. Press , scroll  to HS SETTINGS and press .
2. Scroll to RING SETUP, press .
3. Press  until RING VOLUME is displayed and press .
4. The current external ringtone will play at the current volume. Use the  or  button to increase or decrease the volume, or turn the ringer off. You will see the volume level change on the display or VOLUME OFF will be displayed if you turn the ringer off.

5. Press  to save your choice, you will hear a confirmation tone.

### Turn the handset tones on or off

1. Press , scroll  to HS SETTINGS and press .
2. ALARM is displayed. Press  until TONE SETUP is displayed and press .
3. KEY TONE is displayed, press  or press  to display BATTERY TONE or OUT OF RANGE TONE and then press .
4. Press  or  to select ON or OFF then press  to save, you will hear a confirmation tone.

There are three handset tones: keypad tones, battery tones and out of range tones. You can turn these on or off, the default setting is On.

Keypad tones: when turned on, you will hear a beep after each button press.

To alert you that the battery needs charging, you will hear a low battery tone while you are on a call.

You will also hear a warning tone if the phone goes out of range.

## 44 Settings







A handset name can be a maximum of 12 characters.

The default setting for all call settings is On.









If Auto answer is set to On you can answer a call by lifting the handset off the base. If it's set to Off, you'll need to lift the handset off the base and then press .

Choose from 5 base ringtones. The default base ringtone is Melody 1.

### Change the handset name







1. Press , scroll  to HS SETTINGS and press .
2. ALARM is displayed, press  until RENAME HS is displayed and press .
3. Edit the name by selecting **Del.** to delete the characters, then enter the new name and press  to save. You will hear a confirmation tone.

### Change the call settings









1. Press , scroll  to HS SETTINGS and press .
2. ALARM is displayed, press  until AUTO ANSWER is displayed and press .
3. Press  or  to select ON or OFF then press  to save, you will hear a confirmation tone.

## Base settings







### Set the base ringtone

1. Press , scroll  to BS SETTINGS and press .
2. BS RINGER is displayed, press .
3. The current ringtone will be played at the base. Press  or  to hear the different ringtones and press  to save your choice. You will hear a confirmation tone.

### Set the base ringer volume

1. Press , scroll  to BS SETTINGS and press .
2. BS RINGER is displayed, press  until RING VOLUME is displayed and press .
3. The current base ringtone will play at the current volume. Use the  or  button to increase or decrease the volume, or turn the ringer off. You will see the volume level change on the display.
4. Press  to save your choice. You will hear a confirmation tone.

### Set a PBX access code

1. Press , scroll  to BS SETTINGS and press .
2. BS RINGER is displayed, press  until PBX ACCESS is displayed and press .
3. Enter the number you want (maximum of 1 digit) and press  to save. You will hear a confirmation tone.

There are 5 base ringer volume levels plus Ringer Off. The default setting is Level 3

If you're connected to a switchboard, you might need to enter an access code (e.g.9) before each number is dialled. Your BT1700 can store an access code which is automatically dialled before each number.

If you wish to revert to not using a PBX access code, you need to go into the PBX code menu and delete all the digit by selecting Del., then press  to save.









The default system PIN is **0000**. You can change this to your own preferred 4-digit code.

The system PIN is used when changing certain settings and for registration/de-registration.





If you make a mistake, select **Del.** to delete a digit.

If you reset the phone settings all the phone settings will return to their default settings, e.g. the handset name, ringer melody, all volume levels, display and alarm settings.

### Change the system PIN

1. Press , scroll  to **BS SETTINGS** and press .
2. **BS RINGER** is displayed, press  until **CHANGE PIN** is displayed and press .
3. You will be prompted to enter the current 4 digit PIN, then press .
4. Enter the new 4 digit PIN again and press .
5. Enter the new 4 digit PIN again to confirm and press . You will hear a confirmation tone.











### Reset the handset or base settings

1. Press , scroll  to **DEFAULT** and press .
2. **PIN?----** is displayed, enter the 4 digit PIN and press .
3. **CONFIRM?** is displayed, press . You will hear a confirmation tone.











# Clock/Alarm

If you didn't set the time and date when you first set-up your phone then you will need to do so before you can set an alarm. The clock will also be displayed on the handset screen in idle mode.

## Set the time and date

1. Press , scroll  to HS SETTINGS and press .
  2. Scroll  until DATE & TIME is displayed and press . SET TIME is displayed, press .
  3. Enter the time using the keypad. Press  or  to toggle between A for AM or P for PM, and press .
  4. Enter the year using the keypad and press .
  5. Enter the date using the keypad and press .
- You will hear a confirmation tone.

## Set an alarm

1. Press , scroll  to HS SETTINGS and press .
2. ALARM is displayed, press .
3. Press  or  to turn the alarm ON (or OFF) and press .
4. Enter the alarm time using the keypad. Press  or  to toggle between A for AM or P for PM, and press . SNOOZE is displayed, press .



You must enter the full date: day, month and year.

The time is set in 12 hour format.

Press  or  to toggle between 'A' for AM or 'P' for PM.

When you've set an alarm, the  icon will appear on the idle screen to confirm an alarm has been set.

If an incoming call is received while the alarm is going off, the alarm notification will immediately stop and the incoming call will be shown on the display. The alarm will not resume.

5. Press  or  to turn the snooze ON or OFF, press  to confirm your choice. You will hear a confirmation tone.

### **Stopping the alarm when it goes off**

When the alarm goes off, the selected ring tone will play and ALARM ON will flash.

To stop the alarm, press any key.





If snooze function is activated, the alarm will sound again after seven minutes until you go into alarm settings and turn it off.



# Using additional handsets

If you've bought a BT1700 multiple pack, any additional handsets come pre-registered to the base. However, if you purchase an additional handset separately, you must register it to your BT1700 base before it can be used.

## Register an additional handset

1. Press and hold the  button on the base for 5 seconds. The base is entered into registration mode. You will hear a confirmation tone.
2. Press , scroll  to REGISTRATION and press .
3. Enter the 4 digit PIN and press . The default system PIN is 0000.
4. Once registration is successful the handset will show HANDSET X (with X being the next assigned handset number).

You can register up to five GAP compliant handsets to your BT1700 base to extend your phone system without needing to install telephone extension sockets for each new phone.

If a handset becomes un-registered it will need to be registered to the base again.

If registration isn't successful the first time, please try again in case the base registration period ran out of time.

If there are already five handsets registered to the base, the registration will fail. You must de-register another handset before you can register the new one.

### Registering another make of handset to your BT1700 base









If you want to register another make of handset (i.e. not a BT1700 handset) to your BT1700 base you will need to follow the Registration instructions that came with the handset first and then continue with the base part of the registration procedure.

Please note that registering other types of handset will only provide limited compatibility i.e. you may only be able to make and receive calls on the additional handset.

You can also choose **All handsets** if you want to call all handsets registered to the base. If a handset answers, the handset name will be displayed on your screen.





If an external call is received while an internal call is being made, the handsets registered to the base will display the external call information and you will hear the call waiting tone in the handset earpiece.

### De-register a handset

1. Press , scroll  to **BS SETTINGS** and press .
2. Press  until **DELETE HS** is displayed and press .
3. Enter 4 digit system PIN and press .
4. Press  or  to display the handset you wish to de-register and press . You will hear a confirmation tone.



### Make an internal call between handsets

If you have more than one handset registered to the base, you can make internal calls between two handsets.

1. Press  and scroll  or  to registered handset you want to call.
2. Press  to call the selected handset.
3. Press  to end the call.

### Transfer a call

You can transfer an external call to another handset registered to the base.







1. During a call, press the  button, **INTERCOM** is displayed.
2. Press  and scroll  or  to handset you want

to transfer the call to, press  to establish internal call.

3. Press  to complete call transfer.

### Hold a 3-way call

You can hold a 3-way call between 2 handsets, if you have more than 1 registered to your base and 1 external caller.

1. During a call, press the  button, INTERCOM is displayed.
2. Press  and scroll  or  to handset you want to transfer the call to, press  to establish internal call.
3. Press and hold  on the call handset to establish a conference call, CONFERENCE is displayed.
4. Both parties on conference call will need to press  to end the external call.

You can also choose All handsets if you want to call all handsets registered to the base. If a handset answers, the handset name will be displayed on your screen.

If the internal call is not answered after 30 seconds you will see Handset not available on your display and you will be returned to your external caller.

# Help

---

## **Phone doesn't work**

- Have you activated the batteries correctly? See page 5.
- Check that the mains power is correctly connected.

## **No dial tone or line cord error message displayed on screen**

- Is the telephone cord plugged into the base and phone wall socket?
- Check that the mains power is correctly connected.
- Only use the telephone cord supplied with the phone.

## **Can't make or receive calls**

- Check that the mains power is correctly connected.
- The batteries may need recharging.
- Has there been a power cut? If so, place the handset back on the base for ten seconds and try again. If it still doesn't work, disconnect the batteries and mains power for ten minutes, then reconnect and try again.

## **You have a dial tone, but the phone won't dial out**

- If you're connected to a switchboard, check whether you need to dial an access code, see page 45.

## **Handset doesn't ring**

- The ringer volume may be switched off, see page 42.
- Check that the mains power is correctly connected.
- Make sure the handset is registered to the base, see page 49.

**No display**

- The batteries may be flat, dead or incorrectly inserted.
- Recharge or replace the batteries.

**Range icon flashes**

- Make sure the handset is registered to the base, see page 49.
- Check that the mains power is correctly connected to the base.
- Check that the handset is within range of the base.
- If the batteries are low, place the handset on the base/charger to recharge.

**You hear the busy tone when you press **

- Make sure the handset is in range of the base.
- Another handset registered to your BT1700 base may be on the line.

**No Caller Display number/name displayed**

- Have you subscribed to a Caller Display service from your network provider? See page 29.
- The caller may have withheld their number.
- Network may not have the callers number information.
- An exact name/number match was not found in your contacts. Check that you've stored the full STD dialling code.

### **Can't register a handset to a base**

- You can register up to five handsets to your BT1700 base and you can register your BT1700 handset to up to four bases. Check that you've not exceeded the limits.
- Check that you've entered the correct system PIN number (default PIN 0000).
- Check that you're at least one metre away from other electrical equipment to avoid interference when registering.

### **Base unit does not ring, but the lights are on**

- Have you connected the telephone line correctly?
- Is the base ringer set to off?
- You may have a faulty line or socket. Try using another socket or line.  
If you are a BT customer then please call 0800 800 151 or your network provider if you still have problems.

### **Buzzing noise on my phone or on other electrical equipment nearby**

- Sometimes other electrical equipment can interfere with your BT1700 if it's placed too close. We recommend that you place your BT1700 at least one metre away from electrical appliances or metal obstructions to avoid any risk of interference.

## Customer Helpline

If you're still having problems, call us on **0800 218 2182\*** or go to **bt.com/producthelp**

## General sales enquiries

- BT Residential lines – call **150**. BT Business lines – call **152**.
- For non BT line customers, call **0800 800 150** (residential) or **0800 800 152** (business).
- Additional handsets are available to purchase from the Helpdesk on **0800 218 2182\***.

## Billing enquiries

Please see the phone number shown on your BT bill.

# General information

## Important

This equipment is not designed for making emergency phone calls when the power fails. Alternative arrangements should be made for access to emergency services.

This product is intended for connection to analogue public switched telephone networks and private switchboards in the United Kingdom.

### Replacing the handset batteries

After a time, you might find that the handset batteries run out of charge more quickly. This is a standard sign of wear and the batteries will need replacing.

1. Open the battery compartment cover.
2. Lift the battery out and remove the batteries.  
Replace with two new AAA Ni-MH 500mAh rechargeable batteries.
3. Replace the battery compartment cover.

## Caution

Don't immerse batteries in water, throw them into a fire or dispose of them with ordinary domestic refuse. BT accepts no responsibility for damage caused to your BT1700 by using any other types of batteries. There is a risk of explosion if incorrect batteries are fitted.

## Safety information

- Only use the power supply suitable for the BT1700. Using an unauthorised power supply will invalidate your guarantee and may damage the phone. The item code for the base mains power supply is 066773.
- Use only the approved rechargeable batteries supplied. Spare rechargeable batteries are available from the BT1700 Helpline on 0800 218 2182\*.
- Don't open the handset (except to replace the handset batteries) or the base. This could expose you to high voltages or other risks. Contact the Helpline on 0800 218 2182\* for all repairs.
- If the keypad is locked, it is still possible to make calls to 999 and 112 emergency numbers by dialling the number then pressing .
- Radio signal transmitted between the handset and base may cause interference to hearing aids.
- It is recommended that advice from a qualified expert be sought before using this product in the vicinity of emergency/intensive care medical equipment.
- It is recommended that if you have a pacemaker fitted you check with a medical expert before using this product.
- Your product may interfere with other electrical equipment, e.g. TV and radio sets, clock/alarms and computers if placed too close.
- It is recommended that you place your product at least one metre away from such appliances to minimise any risk of interference.



- Never dispose of batteries in a fire. There is a serious risk of explosion and/or the release of highly toxic chemicals.

## Cleaning

- Clean the handset and base (or charger) with a damp (not wet) cloth, or an anti-static wipe. Never use household polish as this will damage the product. Never use a dry cloth as this may cause a static shock.

## Environmental

- Do not expose to direct sunlight.
- The handset may become warm when the batteries are being charged or during prolonged periods of use. This is normal. However, we recommend that to avoid damage you do not place the product on any surface susceptible to heat damage.
- Do not stand your product on carpets or other surfaces which generate fibres, or place it in locations preventing the free flow of air over its surfaces.
- Do not submerge any part of your product in water and do not use it in damp or humid conditions, such as bathrooms.
- Do not expose your product to fire, explosive or other hazardous conditions.
- There is a slight chance your phone could be damaged by an electrical storm. We recommend that you unplug the power and telephone line cord during an electrical storm.

## How to recycle your equipment

The symbol shown here and on the product means that the product is classed as electrical or electronic equipment, so DO NOT put it in your normal rubbish bin.



It's all part of the Waste Electrical and Electronic Equipment (WEEE) Directive to recycle products in the best way – to be kinder to the planet, get rid of dangerous things more safely and bury less rubbish in the ground.

You should contact your retailer or supplier for advice on how to dispose of this product in an environmentally friendly way.

### Warning

You won't be able to call 999 from this phone if there's a power cut, so make sure you've got another way to call for help in an emergency.

### R&TTE Directive & Declaration of Conformity

This product is intended for use within the UK for connection to the public telephone network and compatible switchboards.

This equipment complies with the essential requirements for the Radio Equipment and Telecommunications Terminal Equipment Directive (1999/5/EC).

For a copy of the Declaration of Conformity please refer to [bt.com/producthelp](http://bt.com/producthelp)

### Guarantee

Your BT1700 is guaranteed for 12 months from the date of purchase.

Subject to the terms listed below, the guarantee will provide for the repair of, or at BT's or its agent's discretion, the option to replace the BT1700 or any component thereof, (other than batteries), which is identified as faulty or below standard, or as a result of inferior workmanship or materials. Products over 28 days old from the date of purchase may be replaced with a refurbished or repaired product.

#### Guarantee conditions

- The guarantee shall only apply to defects that occur within the 12 month guarantee period.
- Proof of purchase is provided.
- The equipment is returned to BT or its agent as instructed.
- This guarantee doesn't cover any faults or defects caused by accidents, misuse, fair wear and tear, neglect, tampering with the equipment, or any attempt at adjustment or repair other than through approved agents.
- This guarantee does not affect your statutory rights.

#### Within the 12 month guarantee period

Prior to returning your product, please read the Help section beginning on page 52 or contact the BT1700 Helpline on **0800 218 2182\***. Additional answers to frequently asked questions are available from **bt.com/producthelp**

In the unlikely event of a defect occurring, the helpdesk will issue a Fault Reference Authorisation (FRA) number and instructions for replacement or repair. Please note you will need the FRA number before returning the product. This does not affect your statutory rights.

#### Outside of the 12 month guarantee period

If your product needs repair after the guarantee period has ended, the repair must meet the approval requirements for connection to the telephone network. We recommend that you contact BT's recommended repair agent Discount Communications on **0800 980 8999** or a local qualified repairer.

#### Returning your phone

If the Helpline is unable to remedy your problem they will issue a Fault Reference Authorisation number and ask you to return the product to your original place of purchase. Where possible, pack the product in its original packaging. Please remember to include all parts, including the line cords, power supply units and the original batteries.

## Technical information

### How many telephones can I have?

All items of telephone equipment have a Ringer Equivalence Number (REN), which is used to calculate the number of items which may be connected to any one telephone line. Your BT1700 has a REN of 1. A total REN of 4 is allowed. If the total REN of 4 is exceeded, the telephones may not ring. With different telephone types there is no guarantee of ringing, even when the REN is less than 4.

Any additional handsets and chargers that you register have a REN of 0.

## Connecting to a switchboard

### Switchboard compatibility

This telephone may be connected to most types of switchboard, however in the event of any difficulties, consult your switchboard Service Provider.

### Recall (R)

Recall is used when connected to certain switchboards/PBXs and some BT Calling Features, or those services available via your network provider. The BT1700 supports time break recall but not earth loop recall.

## R&TTE

This product is intended for use within the UK for connection to the public telephone network and compatible switchboards.

This equipment complies with the essential requirements for the Radio Equipment and Telecommunications Terminal Equipment Directive (1999/5/EC).

## Declaration of Conformance

Hereby, BT declares that this BT1700 is in compliance with the essential requirements and other relevant provisions of Directive 1999/5/EC.

If you would like a copy of the Declaration of Conformance, please visit [bt.com/producthelp](http://bt.com/producthelp)

## For your records

Date of purchase:

Place of purchase:

For guarantee purposes, proof of purchase is required, so please keep your receipt.

Enter your base system PIN here:

[ / / / ]

Enter your remote access PIN here:

[ / / / ]

For a Better Future 

We're always looking to make our products last longer and use less power, so we don't have such a big impact on the environment.

To find out about what we are doing, visit  
**[bt.com/betterfuture](http://bt.com/betterfuture)**



## Offices worldwide

The services described in this publication are subject to availability and may be modified from time to time. Services and equipment are provided subject to British Telecommunications plc's respective standard conditions of contract. Nothing in this publication forms any part of any contract.

© British Telecommunications plc 2016.  
Registered Office: 81 Newgate Street, London EC1A 7AJ.  
Registered in England No. 1800000.

Printed in China.  
Designed by The Art & Design Partnership.

Available in other formats including braille, large print or audio CD.  
If you would like a copy, please call 0800 218 2182\*.

\* Calls made from within the UK mainland network are free.  
Mobile and international call costs may vary.

