



Aastra 142d

AASTRA

DECT Telephone User Guide

Communications systems

Aastra 800
OpenCom X320
OpenCom 130/131/150
OpenCom 510



Welcome to Aastra

Thank you for choosing this Aastra product. Our product meets the strictest requirements with regard to quality and design.

The following operating instructions will assist you in using your Aastra 142d DECT telephone and answer most of the questions that may arise. If you should require any further technical support or information about other Aastra products, please first contact the person responsible for your system or get in touch with your local retailer.

You can also find information about this phone and other products on our website at **<http://www.aastra.de>** or **<http://www.aastra.com>**.

We hope you enjoy using your Aastra 142d DECT telephone.

Aastra 800 and OpenCom 100

This user guide applies to the Aastra 800 and OpenCom 100 communications systems. The OpenCom 100 product family comprises the OpenCom 130, OpenCom 131, OpenCom 150, OpenCom 510 and OpenCom X320 communications systems.

If individual features differ on the systems, a reference is made in this user guide.

Contents

Using the Aastra 142d Telephone	7
Appropriate Use	7
Power Supply / Power Failure / Batteries.....	8
Safety Information	8
Communications Regulation Information	9
FCC Notices (U.S. Only)	9
Health and Safety Information	10
Industry Canada (Canada only).....	10
Overview and Basic Information	11
Authorisation is Required.....	11
Further Documentation	11
DECT and GAP	12
MEM Card.....	12
The Headset Socket	13
Installation	14
Unpacking and Setting up Telephone	14
Scope of Delivery.....	14
Setting up Charging Station	14
Activating Charging Station	15
Activating Mobile Unit	16
Important Battery Information.....	16
Charging and Discharging.....	16
Commissioning	16
Charging and Usage Times	17
Inserting/Removing Batteries.....	17
Charge Display	19
Charge Warning.....	19
Aastra 142d with MEM Card	20
General Information.....	20
Operation with/without MEM Card.....	20
Inserting MEM Card	20
Removing MEM Card	22

Subscribing Mobile Unit	22
The “Subscriptions” Menu	23
Creating New Subscription	25
Attaching/Removing Belt Clip	27

Functions 28

Operational Controls on the Mobile Unit..... 28

Display Elements and Symbols..... 29

The Display	29
Symbols Shown on the Display	29
Text Lines	30
Softkey Line.....	30
Illumination	31

Softkeys and Other Keys..... 31

Softkey: Arrow Keys	31
Softkey: OK.....	32
Softkey: Esc	32
Softkey: Redial	32
Softkey: Menu.....	32
Receiver Key	32
Speaker/Handsfree Key	32
Info Key	32
C Key (Delete Key)	33
R Key (Signal Key) / Emergency Call Key	34
Hash Key	34
Star Key	34
Number Keys.....	34

Locking Your Telephone Interface by the System Administrator 35

The Editor 35

Menu Navigation..... 37

The Main Menu	37
Menus Hide Automatically	38

Basic Functions 39

Device Functions..... 39

Switching Device On/Off	39
Key Lock	40

Telephone Lock	40
Speaker/Handsfree Use	40
Adjusting Volume During a Call	41
Setting Volume for Incoming Calls	41
Switching off Ringer	41
Muting Mobile Unit	42
Changing Display Contrast	42
Time/Alarm	42
Message Display	42
Emergency Call Key (SOS Number)	42
Connections	43
Internal and External Call Numbers	43
Multiple Trunk Keys	43
Multiple Connections	43
DTMF Postdial/VF Signalling	43
Charge Display (Charges)	44
Transmission of Call Numbers	44
Blocked/Unblocked Call Numbers	45
Keypad Dialling	45
Least Cost Routing (LCR)	45
Calls in the Call-Waiting Queue	46
Calls with Booking Numbers	47
Forwarding Calls	47
Menus	49
Menu Before and During a Call	49
Menu when Idle	49

Telephoning..... 52

External/Internal Calling	52
External Seizure and Entry of Call Numbers	52
Dialling Directly	53
Pre-dialling	53
Redial	53
Calling from the Caller Lists	55
Call Waiting with an Internal Subscriber	56
Using Routes to Make Calls	56
Menu during Conversation	56
Menu if Subscriber Busy	58
Menu during the Call	58

Ending a Call	59
Accepting Calls	59
Optical Call Display	59
Temporarily Switching off Call Signalling	59
Normal Call	59
VIP Calls	60
Calls during a Conversation	60
Incoming Call Menu	61
Call Waiting Menu	61
Enquiry, Toggling, Transfer and Conference	62
Enquiry/Toggle via the R (Signal) Key	62
Transferring an Internal/External Call to an Internal Subscriber	63
Transferring an External Call to an External Subscriber	64
Menu when Subscriber on Hold	64
Three-Party Conference	65
Menu During the Conference	67
Special Calls/Conversations	68
Callback	68
Accepting an Appointment Call	68
Baby Call	69
Parking Calls	69
Announcements (with and without Intercom)	70
Doorbell, Door Opener	72
Entrance Intercom Calls	73
Voicebox Queries	74

Phone Book	75
Communications System Phone Books	75
Calling from the Communications System Phone Book	75
Speed-Dialling	77
Add Phone Numbers from Lists or during Call to Communications System Phone Book	77
The Local Phone Book of Your Aastra 142d	79
Calling from the Local Phone Book of Your Aastra 142d	79
Editing Local Phone Book Entries of Your Aastra 142d	80

Features and Menu	81
How to Set Features	81
"Main" Menu	81
"Calls" Menu	82
"Call forwarding" Menu	85
"Messages" Menu	87
"Phone Settings" Menu	89
"Protection" Menu	96
"Connections" Menu	97
"Phone book" Menu	100
"Applications" Menu	102
"Central settings" Menu	102
Information Menus	103
"Info" Menu	103
"Active features" Menu	104
Installing USB Drivers	105
Updating Software	106
PC Tool for Managing the Phone Book	107
Appendix	108
Important Information on Battery Use	108
Care and Maintenance	109
Environmental Properties and Disposal	110
Notes on Disposal	110
Declaration of Conformity	111
Limited Warranty	111
Exclusions	111
Warranty Repair Services	112
After Warranty Service	112
Technical Data	113
Menu Tree	115
Index	116

Using the Aastra 142d Telephone

The Aastra 142d is a cordless telephone for operation on the OpenCom 100 / Aastra 800 communications system. You can also operate your mobile unit on other communications systems and thus use the same mobile unit at different locations. Operation on communications systems by other manufacturers is still possible when they comply with the GAP standard.

The newly designed menus offer you easy handling of your telephone and speedy access to the wide variety of functions and features of your system.

Features and programme functions can be configured directly on the telephone and just as conveniently using the **Configurator** of the OpenCom 100 / Aastra 800 communications system.

Make yourself acquainted with your telephone's capabilities. You will get to know many new functions which make communication and organization easier for you.

Appropriate Use

This product can be operated on a DECT-GAP-compatible communications system in all EU member countries. The telephone complies with radio-specific European-harmonised DECT standards.

The CE mark on the product confirms conformity with the technical regulations regarding user safety and electromagnetic compatibility, valid as of the issue date of the corresponding Declaration of Conformity according to European Directive 99/5/EC. The Declaration of Conformity can be viewed on the Aastra internet homepage.

This device remains approved for use in North America (USA and Canada). Please refer to the safety information under [Communications Regulation Information](#) starting on page 9.

Please use the other included documentation on parts of your communications system.

As is the case with any cordless telephone, this mobile unit uses radio signals which do not guarantee a connection under all circumstances. This is why you should never completely rely on cordless telephones for essential communication (e.g. for medical emergencies).

Power Supply / Power Failure / Batteries

This product requires a 100V to 240V alternating current power supply for operating the charging station. When you wish to disconnect the charging station from the power supply, pull the power supply unit plug out of the mains socket.

If there is a power outage, all memory data (programme and user data) are saved on the mobile unit without alteration.

Please refer to page 108 for important information on battery use.

Safety Information

The charging station may only be set up and operated within a closed building.

Place the charging station on an anti-slip mat.

Do not set up the charging station and mobile unit near:

- water, moisture or damp places
- heat sources, direct sunlight or unventilated places
- devices which generate powerful magnetic fields
- places where the device can be covered up or liquid can get in
- dusty places and places subject to vibrations, shocks or extreme temperature fluctuations.

Please be sure to note the following when setting up, connecting and operating the telephone:

- Position the connecting cable where it will not cause an accident!
- Be sure to only connect the connecting cable into appropriate sockets.
- Connect only approved accessories.
- Use the supplied AC adapter (ID No.: 23-001071-00) only.
- Do not use any power supply that is visibly damaged (ruptures, housing cracks).
- Research has demonstrated that in certain cases medical devices can be affected by portable telephones (DECT) that are switched on. This is why when within medical institutions you should be sure to comply with the regulations of the respective institution when using portable telephones.

- Do not hold the telephone in the hands-free mode next to your ear as the volume can be very high.
- This product's earcap region (at the front) and the loudspeaker region (at the rear) is slightly magnetic and may pick up metallic objects, such as staples or pins. Please check both regions for metallic objects before use.

WARNING!

Never

- **open the charging station or the mobile device (aside from the battery compartment lid)!**
 - **touch the plug contacts with sharp, metal objects!**
 - **carry the charger by the connecting cable!**
-

- Only use a slightly damp or an anti-static cloth to clean your telephone. Never use a dry cloth. Never use cleansing agents.
- Do not use your telephone in areas at risk of explosion.
- Set up and keep mobile device and accessories outside the reach of children.

Note for persons wearing hearing aids

Persons wearing hearing aids should keep in mind that when using the mobile device at sufficient volume, the resulting radio signal interference produces an unpleasant humming noise.

Communications Regulation Information

FCC Notices (U.S. Only)

This device complies with part 15 of the FCC Rules. Operation is subject to the following two conditions:

(1) This device may not cause harmful interference, and (2) this device must accept any interference received, including interference that may cause undesired operation.

Modifications not expressly approved by this company could void the user's authority to operate the equipment.

NOTE: This equipment has been tested and found to comply with the limits for a Class B digital device, pursuant to Part 15 of the FCC Rules. These limits are designed to provide reasonable protection against harmful interference in a residential instal-

lation. This equipment generates, uses and can radiate radio frequency energy and, if not installed and used in accordance with the instructions, may cause harmful interference to radio communications. However, there is no guarantee that interference will not occur in a particular installation. If this equipment does cause harmful interference to radio or television reception, which can be determined by turning the equipment off and on, the user is encouraged to try to correct the interference by one or more of the following measures:

- Reorient or relocate the receiving antenna.
- Increase the separation between the equipment and receiver.
- Connect the equipment into an outlet on a circuit different from that to which the receiver is connected.
- Consult the dealer or an experienced radio/TV technician for help.

Health and Safety Information

Exposure to Radio Frequency (RF) Signals:

The wireless phone is a radio transmitter and receiver. It is designed and manufactured not to exceed the emission limits for exposure to radio frequency (RF) energy set by the Federal Communications Commission (FCC) of the U.S. Government. These limits are part of comprehensive guidelines and establish permitted levels of RF energy for the general population. The guidelines are based on the safety standards previously set by both U.S. and international standards bodies. These standards include a substantial safety margin designed to assure the safety of all persons, regardless of age and health.

This device and its antenna must not be co-located or operating in conjunction with any other antenna or transmitter.

This EUT has been shown to be capable of compliance for localized specific absorption rate (SAR) for uncontrolled environment/general population exposure limits specified in ANSI/IEEE Std. C95.1-1992 and had been tested in accordance with the measurement procedures specified in FCC/OET Bulletin 65 Supplement C (2001) and IEEE 1528-2003.

Industry Canada (Canada only)

Operation of this device is subject to the following two conditions: (1) this device may not cause interference, and (2) this device must accept any interference, including interference that may cause undesired operation of the device.

Privacy of communications may not be ensured when using this telephone.

Exposure to Radio Frequency (RF) Signals:

The wireless phone is a radio transmitter and receiver. It is designed and manufactured not to exceed the emission limits for exposure to radio frequency (RF) energy set by the Federal Communications Commission (FCC) of the U.S. Government. These limits are part of comprehensive guidelines and establish permitted levels of RF energy for the general population. These guidelines are based on the safety standards previously set by international standard bodies. These standards include a substantial safety margin designed to assure the safety of all persons, regardless of age and health.

This device and its antenna must not be co-located or operating in conjunction with any other antenna or transmitter.

This device has been shown to be capable of compliance for localized specific absorption rate (SAR) for uncontrolled environment / general public exposure limits specific in ANSI/IEEE C95.1-1992 and had been tested in accordance with the measurement procedures specified in IEEE 1528-2003.

Overview and Basic Information

Authorisation is Required

Most of the features mentioned in this manual can only be used when you have the corresponding user authorisation. Your system administrator configures authorisations when configuring the communications system.

Contact the system administrator when you have questions on specific features or are not able to use a feature satisfactorily.

Further Documentation

Please use the other included documentation on parts of your communications system. This documentation is on the OpenCom 100 product CD (on the USB stick that comes with an Aastra 800).

The Glossary

This user guide describes all the basic functions of your telephone. Should you require further information on the system's features, please refer to the glossary provided with your communications system.

DECT and GAP

A digital radio connection is established between the mobile unit and the base station (Radio Fixed Part, RFP) in accordance with the DECT standard (DECT = Digital Enhanced Cordless Telecommunications). The digital channel ensures the best voice quality without static or background noise. The Generic Access Profile (GAP) is used for signalling between the communications system and the mobile unit.

The Generic Access Profile (GAP) and the DECT standard define procedures according to which digital cordless telephones can establish connections. The GAP standard applies independent of manufacturer, meaning that communications systems and mobile units of various manufacturers can be combined. The basic functions (telephoning, accepting calls) are always available in these combinations; other functions (e.g. displaying the call number on the display, displaying connection charges) which your OpenCom 100 / Aastra 800 communications system provides along with your mobile unit, may not be available with other manufacturers' communications systems. Please consult the corresponding manufacturer's user guide or contact your system administrator.

Information on transmission quality

- Due to digital transmission within the frequency range used – even within range depending on the structural environment – dead spots can result. In this case, transmission quality can be lessened by increased and brief transmission gaps. A slight movement outside the dead spot will re-establish the usual transmission quality. When a caller goes out of range, the connection is disconnected.
- In order to avoid radio-related interference with other electronic devices, we recommend as great a distance as possible (minimum of 1 m) between the charger or mobile unit and other devices (e.g. radios, loudspeakers, etc).

MEM Card

The Aastra 142d is equipped with a memory card (MEM card). The MEM card stores the check-in data of the device, the user name, the display language, a local directory and the device identification (IPEI = International Portable Equipment Identity). This means that when switching devices by inserting the MEM card into another device, this data is available on the other device and calls can be made immediately (without checking in again).

The MEM card is inserted into the battery compartment below the battery. For safety reasons, the device has an additional battery compartment lock. If the MEM card is enclosed separately, you have to insert it in the battery compartment below the

battery. Please refer to the chapter Aastra 142d with MEM Card starting on page 20 for information on how to insert the MEM card into the Aastra 142d.

The Headset Socket

The mobile unit has a 2.5 mm socket for connecting a headset. The Aastra headset accessory only must be used in order to comply with the electrical values.

Installation

There are several steps involved when commissioning for the first time, described in detail in the following sections. These steps comprise these key words:

1. Unpacking telephone, checking scope of delivery and setting up charging station – described under Unpacking and Setting up Telephone starting on page 14.
2. Open telephone, insert MEM card (optional), insert batteries and charge batteries – described under Activating Mobile Unit starting on page 16 and Aastra 142d with MEM Card starting on page 20.
3. Switch on telephone and subscribe it on a communications system or on a GAP base station – described under Subscribing Mobile Unit starting on page 22.

Please read the following sections first before beginning with first-time commissioning.

Unpacking and Setting up Telephone

Scope of Delivery

The packaging contains:

- Aastra 142d mobile unit
- Charging station
- AC adapter (ID No.: 23-001071-00)
- three batteries
- MEM card (please refer to Aastra 142d with MEM Card starting on page 20 also)
- Belt clip
- short user guide

Setting up Charging Station

Your telephone is made for normal usage conditions. Today's furniture is coated with a sheer myriad of lacquers and plastics and treated with various lacquer care products. It is possible that some of these materials contain components which can attack and

deteriorate the plastic feet of the charging station. The device feet altered by these foreign substances may leave undesirable marks on furniture surfaces.

For understandable reasons, the manufacturer cannot assume liability for these types of damage. This is why you should use an anti-slip mat under your charging station – particularly with furniture that is new or has been freshened up with lacquer care products.

Note

Please make sure you do not set up the charging station in the space where doors or windows open: Damage Risk!

Activating Charging Station

Safety precaution

Only use the AC adapter with the ID No.: 23-001071-00 type designation as intended for the charging station!

The power supply unit is suitable for 100V to 240V alternating current (50 - 60 Hz). It comes with 4 interchangeable adapters so it can be used practically anywhere worldwide. As needed, put the connector onto the power supply used in your country.

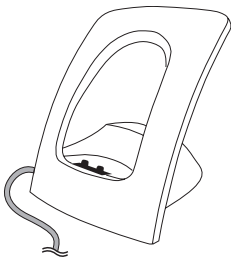

Power Supply

Position the switch on the power supply at OPEN and slide the connector in place upwards and off. Stick the desired new connector into the power supply and push it downwards until it clicks into place.

Insert the power cable into the socket on the charging station and then the AC adapter into a mains socket.

Note

If the AC adapter is not connected or there is a power failure your charging station is not operable. A mobile unit on the charging station which is not connected to the mains socket remains switched on and discharges during the stand-by time.

Activating Mobile Unit

Important Battery Information

Use batteries only as intended. Never use a battery that is damaged or used.

Heat or cold reduce the battery performance and life span. A mobile unit with hot or cold batteries may be temporarily inoperable even though they are fully charged.

Dispose of used batteries in accordance with local government requirements. Be sure to recycle them!

Never throw batteries into a fire.

Charging and Discharging

A battery can be charged and discharged hundreds of times but is used up at some point. If the operation time (i.e. calling and stand-by time) becomes significantly shorter than normal, it is time to replace the batteries.

In order to attain long operation times, batteries should be discharged from time to time by removing the mobile unit from the charging station and leaving it switched on until it switches itself off. Only use this method for discharging batteries.

Extreme temperatures affect the charging capacity of the battery.

Commissioning

Load the battery ca. 5 to 6 hours before using the mobile unit for the first time. This precautionary measure helps extend the battery life span. Maximum battery performance is achieved only after three to five charge and discharge cycles. Place the mobile unit regularly onto the charger to charge the battery optimally.

Observe the correct polarity when replacing the batteries (see page 18).

Note

It is strictly mandatory to use only those battery types approved by the manufacturer. If other battery types are used, the manufacturer assumes no liability for any defective functioning or damages occurring.

The batteries have to be charged first for your mobile unit to be operational. Now you can subscribe the mobile unit (see Subscribing Mobile Unit starting on page 22). Then you can use your mobile unit to make a call.

Charging and Usage Times

- **Charging time:** (fully discharged batteries) to full capacity in 5 to 6 hours
- **Talk Time:**
 - up to 18 hours (fully charged) for North America
 - up to 15 hours (fully charged) for other countries
- **Stand-by Time:**
 - up to 125 hours (fully charged) for North America
 - up to 140 hours (fully charged) for other countries

Note

Batteries whose charge level is unknown take ca. 14 hours to fully charge.

Poor radio connections (large distance from system radio station) reduce the stand-by and talk time of the mobile unit. High speaker or ringer signal volume, frequently activated key and display lighting as well as activated vibration alarm are also features decisive in reducing stand-by and talk times.

Inserting/Removing Batteries

There is a battery compartment on the lower side of the mobile unit for the three included AAA batteries. The appendix contains important information on battery use (see page 108).

Proceed as follows to insert and remove the battery pack:

Opening the battery compartment

To unlock the battery compartment cover, use a pointed object (e.g. a ballpoint pen) and push it into the hole at the bottom of the handset (1). Lift away the cover at the same time as illustrated (2).



Inserting the three batteries (note polarity)

Observe the correct polarity of the batteries. The + - marking in the battery compartment must be aligned with the + - marking on the batteries. Batteries can be inserted without force. If batteries are inserted with incorrect polarity, this may damage the device.

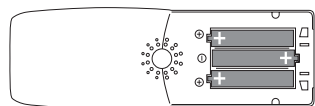

Closing the battery compartment

After inserting the MEM card (please refer to page 20), position the battery compartment cover slightly diagonally as shown (1) and flip it downwards (2) until it has clearly clicked into place.

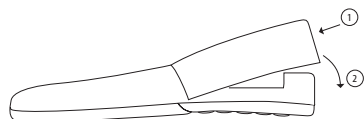

Note

Switch off the mobile unit before removing the batteries as there may be a loss of data otherwise.

Charge Display

The charging status of the battery is shown on the display. The following means:



81 - 100 % charged



61 - 80 % charged



41 - 60 % charged



21 - 40 % charged



0 - 20 % charged



(Frame flashes) Battery nearly discharged,
warning tone issued

Your handset has a “battery management system” that must determine the limits of the battery charging status before it can display an accurate charge level.

When the battery has been replaced, the charge level is not correctly displayed until a whole charge and discharge cycle has been completed.

Charge Warning

When the battery capacity is nearly exhausted, the battery symbol will flash in the display and you hear a “3-beep” acoustic warning signal every minute. If you are making a call at the time, you have 5 minutes to complete the call before the mobile unit shuts itself off. If you are not making a call and the handset is not in the charging station, “Battery Alarm” appears on the display. You can no longer make a telephone call now.

NiMH batteries only, never use common batteries / primary cells (see page 108).

Note

You can replace your mobile unit back onto the charging station after each call. The charging process is controlled electronically so that batteries at whatever charge level are optimally and carefully charged. Avoid removing the batteries for no particular reason from the mobile unit as this impairs the optimal charging process. The capacity of the batteries used can be improved when after more lengthy usage periods the batteries are fully discharged and then fully recharged (see also page 16).

Aastra 142d with MEM Card

General Information

The Aastra 142d can be equipped with a memory card (MEM card). The MEM card stores the local directory, the display language, the user name and the check-in data as well as the device identification (IPEI = International Portable Equipment Identity). This means that when switching devices by inserting the MEM card into another device, this data is available on the other device and calls can be made immediately (without checking in again).

Operation with/without MEM Card

The Aastra 142d when commissioning for the first time, without a MEM card, is also fully operational (without the above mentioned advantages). However, if you have inserted a MEM card (which also already adopted the telephone's data), then removing it causes the Aastra 142d to become non-functional until a programmed MEM card is inserted.

Programmed MEM card means: a MEM card that has been inserted in another device or a MEM card that has been especially prepared by the service department (e.g. as replacement).

Inserting MEM Card

Safety precaution!

The MEM card must be handled with a great deal of care. The contacts must be free of dust, moisture, grease, etc. Do not store the MEM card in warm areas (e.g. direct sunlight). Do not bend the MEM card; the contacts can be broken.

The MEM card is inserted into the battery compartment below the battery.

1. Using your finger, first remove the small MEM card from the larger frame.

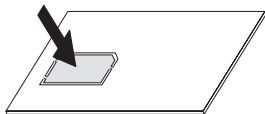

2. Open the battery compartment (see page 17) and remove the batteries (if these have already been inserted).

- Slide the MEM card cover in the battery compartment in the arrow direction (OPEN). Gently pivot the cover upwards.

Note: Never touch the shiny gold contacts now visible! Static discharge can cause the device to become defective.

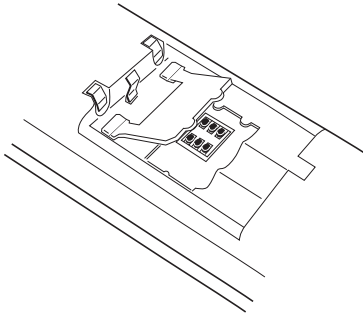

- Slide the MEM card (with the contacts facing downwards) under the half-moon holders (a) in the MEM card compartment. Ensure that the bevelled edge of the MEM card is to the bottom left while doing so.
- Press the MEM card down until it audibly locks into place.

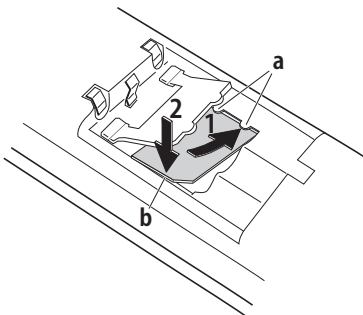

- Close the MEM card compartment with the cover. Slide the cover notches into the case until the cover is completely covering the MEM card.
- Insert the batteries and close the battery compartment (see page 17).

Removing MEM Card

It is only necessary to remove the MEM card if you pass the mobile unit on to someone or if you need the MEM card for a new mobile unit.

After having removed the batteries (see page 17):



1. Slide the MEM card cover in the battery compartment in the arrow direction (OPEN). Gently pivot the cover upwards.
2. Use a pointed object to push onto the release (b), see diagram on page 21.
3. Take the MEM card out.

Subscribing Mobile Unit

Your mobile unit can be operated on a maximum of 10 different communications systems. To do so, it has to be subscribed to each system, i.e. subscribed and checked in.

The subscription procedure is usually done when commissioning the device. This is usually done by your system administrator for you when operated on the OpenCom 100 / Aastra 800 communications system. Subscribing is done via the following steps:

1. Switch on the mobile unit. To do so, press the  key.

When commissioning for the first time, the **Language** menu appears. Use the  arrow keys to select the desired display language. Confirm with the  key or with the  softkey.

2. When commissioning for the first time, the **Subscriptions** menu automatically appears on the display with the **No Subscription** notification. Press the  softkey to start subscription (please refer to page 25).

If you do not wish to immediately start checking in, after a few seconds **No Subscription** appears on the mobile unit on the idle display. In this case, call the "Subscriptions" menu on the mobile unit to create a new subscription entry (please refer to page 23).

3. Subscription if the mobile unit is already subscribed to one or more communications systems: select a subscription entry to be used for checking in (see Managing existing subscription starting on page 92).

After completion of this process, the mobile unit is ready for operation.

The following applies to other manufacturers' communications systems:

Subscribe your mobile unit with the communications system as described in the manufacturer manual.

If you wish to subscribe your mobile unit to another communications system, please consult the corresponding documentation. If you wish to subscribe the mobile unit to another GAP-compatible system, the system, however, is refusing to do so, please activate the "GAP only" feature in the "Phone settings > System > Subscriptions" menu (see page 93). GAP-protocol compliant features only are available with this setting. When operating a system terminal on the OpenCom 100 / Aastra 800 communications system, this feature must not be activated!

Note for the System Administrator

If you are operating a DECT network on an Aastra 800 communications system, please read the more detailed information as well in the "Installing and Commissioning" guide and in the online help on the topics DECT networks and DECT areas. This is where you will find details on configuring DECT base stations and on checking in DECT terminals in DECT areas.

The "Subscriptions" Menu

The content of the **Subscriptions** menu and the position of this menu entry depend on the current subscription state. Access to the **Subscriptions** menu differs and depends on whether

- the mobile unit has no subscription yet, such that the device cannot be checked in either (see page 23),
- or the mobile unit is already checked in on a communications system (see page 24).

No subscription

When doing first-time commissioning or if all subscriptions have been deleted, start the subscription to a communications system with the following steps:

- | | |
|---|---|
| Menu | Press softkey. |
|  | Use the arrow keys to select the System menu entry. |
| OK | Press softkey. The Subscriptions menu entry is now selected in the System menu. |

OK Press softkey. The **Subscriptions** menu opens. **No Subscriptions** appears on the display.

New Press softkey to begin subscription. The procedure is identical to the one described in the [Start subscription](#) section on page 25.

Mobile unit is already checked in to the communications system

During normal operation, the mobile unit menus are adapted to the communications system. To manage a subscription or start a new subscription, use the following steps:

Menu Press softkey (long key press).

 Use the arrow keys to select the **Phone settings** menu entry.

OK Press softkey.

 Use the arrow keys to select the **System** menu entry.

OK Press softkey. The **Subscriptions** menu entry is now selected in the **System** menu.

OK Press softkey. A list of the names of the communications systems where the mobile unit is already subscribed is displayed in the **Subscriptions** menu. In addition, the **Auto.Search** menu entry is available.

 Use the arrow keys to select one of the entries.

Options Press softkey. The **New** menu entry is now selected in the **Subscriptions** menu.

OK Press softkey to begin the new subscription. The procedure is identical to the one described in the [Start subscription](#) section on page 25.

Note

You may select an existing subscription entry and change its settings in the **Subscriptions** menu. Please refer to the [Managing existing subscription starting on page 92](#) section for information.

Creating New Subscription

The subscription of the mobile unit to a communications system is necessary for the mobile unit to check in to the communications system. A further requirement is that the communications system can establish a radio connection to the mobile unit (PP = Portable Part) via one or more connected radio stations (RFP = Radio Fixed Part).

When you wish to subscribe the mobile unit, you must configure a new DECT configuration entry in the communications system. The IPEI (International Portable Equipment Identity) of the mobile unit is required for this configuration entry. The IPEI is displayed on the mobile unit at the beginning of subscription (see the following *“Start subscription”* section).

Start subscription

You have selected the **New** menu entry in the **Subscriptions** menu (please refer to the sections *No subscription* on page 23 and *Mobile unit is already checked in to the communications system* on page 24).

Now conduct the subscription with the following steps:

The mobile unit IPEI appears. Read the IPEI and enter it into the communications system Configurator. Enter the desired authentication code (AC = Authentication Code) into the Configurator as well.

OK

Press softkey to continue.



Enter PARK: now enter the PARK of the communications system. The PARK (Portable Access Right Key) identifies the communications system. You can view this number in the communications system Configurator.

If there are no other communications systems within radio range and you have activated simplified registration on the communications system, you can continue without entering a PARK.

OK

Press softkey to confirm and continue.



Enter Auth.Code: now enter the maximum 8-digit code that you entered into the communications system Configurator.

OK

Press softkey to confirm and continue.

The mobile unit begins checking in and displays **Searching for a DECT System**. This procedure should be completed very quickly. If the entries are not correct or the radio connection is inadequate, a progress bar appears on the mobile unit. In this case, cancel the procedure using the **Esc** softkey and repeat the subscription with corrected entries.

Note

When you prefix authentication code entry with the star key, the mobile unit will be checked in as a GAP device.

Tip: The length and quality of the authentication code used depends on your security requirements. Please keep in mind that the memory required for the authentication code increases 4 bits per additional digit.

After checking in successfully, you can enter name and number for the new subscription entry. Confirm with the **OK** softkey.

Note

If you wish to subscribe the mobile unit to a GAP base station for instance, the process is often started with a simplified procedure. In many cases, press a key on the GAP base station to open a subscription time frame. During the time frame, start the simplified subscription and confirm all requirements on the mobile unit with the **OK** softkey.

Attaching/Removing Belt Clip

1. Slide the adapter clip over the back of the mobile unit until the clip snaps into place in the side openings. Pull the clip slightly apart to remove it.

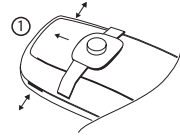

2. Attaching belt clip: press – as shown – the upper end of the belt clip together, slide it over the belt, and let go of the end of the clip.

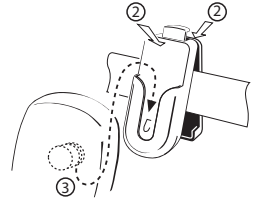

3. Securing mobile unit: slide your mobile unit with the adapter ring into the belt clip until it clicks into place.

4. Removing mobile unit: press the release and pull the mobile unit upwards out of the belt clip.

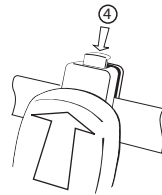

Functions

Operational Controls on the Mobile Unit

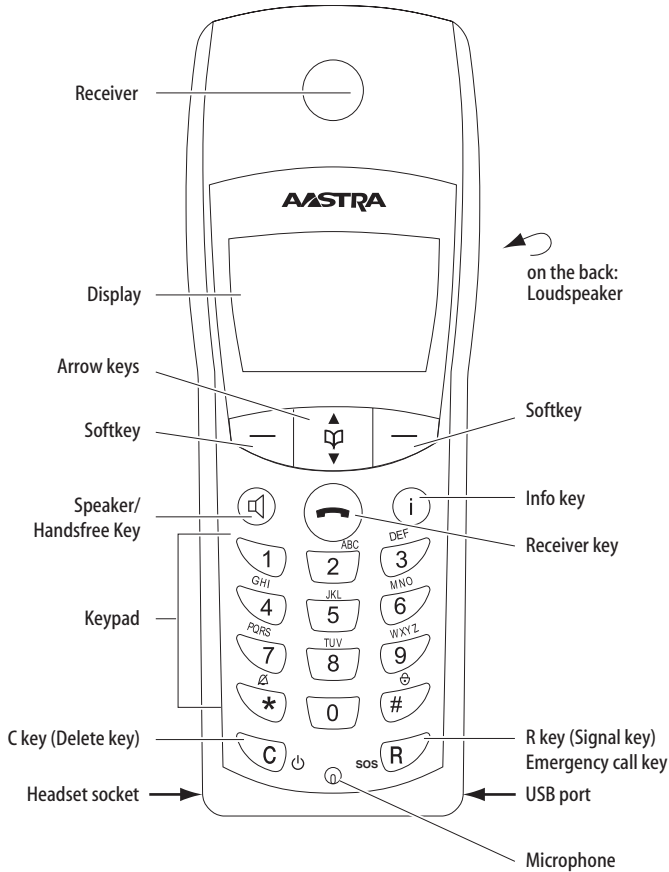

Operational Controls on the Aastra 142d

Display Elements and Symbols

The Display

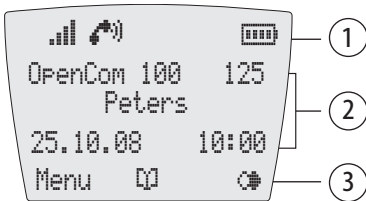











Display on the Aastra 142d

1 symbol line (see page 29)

2 symbol lines (see page 30)

3 symbol lines (see page 30)

Symbols Shown on the Display

-  Quality of the radio connection (four bars: reliable radio connection; only one bar: unreliable radio connection)
-  Connection status (receiver key was pressed)
-  Connection status (speaker/handsfree is activated)
-  Microphone is switched off and can be switched on
-  Microphone is switched on and can be switched off
-  Ringer switched off
-  Charging status of batteries (see Charge Display starting on page 19)
-  Keypad lock is switched on and can be switched off
-  Redial list
-  You have received messages (short messages, e-mail).



You have received a voicebox message. This requires a voicemail system to be connected to your communications system. The symbol is only visible if there is no active connection to the communications system.



Telephone book (see page 75)



You have programmed and activated a local alarm (see page 89).



You have activated a feature that impairs your reachability: Call diversion immediately, Call blocking

Text Lines

The three middle lines of the five-line display shows information on the current connection state or menu lists and texts.

In the idle state you see the name of the communications system, the internal call number of the mobile unit, the programmed user name and the current time. A programmed alarm is still shown. In the call state, you see the call number or the name of the caller/called subscriber on the display.

Pick-lists (e.g. phone book) and the menu for the features are displayed in three line extracts on the display. Use the arrow keys to scroll up or down. A selectable entry appears with a dark background.



Text Lines on the Aastra 142d

Softkey Line

The texts and symbols in this line refer to the keys underneath. The contents of the line change according to the operating status.

Illumination

The display is automatically illuminated when calls are received or when you press a key. The illumination is automatically switched off again ten seconds after the last key was pressed.

Softkeys and Other Keys

Both keys below the display as well as the arrow keys are called softkeys. The functions assigned to the keys are shown in the lowest line of the display. The key function automatically changes depending on the respective operation state of the mobile unit.

Softkey: Arrow Keys

Above the arrow keys you will see symbols that identify the individual functions of the arrow keys:



The up arrow key allows you to select telephone numbers from the phone book of your communications system.



The down arrow key allows you to select telephone numbers from the local phone book of your communications system.



When you are entering call numbers or texts, you can make changes by moving a cursor. The arrow keys allow you to move the cursor to the beginning or end of the entry.



If a pick-list (e.g. phone book or menu) is displayed, you can use the arrow keys to scroll to the desired entry.

If a continuous text is shown (e.g. a message), you can scroll up and down through the text with the arrow keys.



During a call you can change the volume of the receiver/headset or of the loudspeaker using the arrow keys.

Softkey: OK

Use the **OK** softkey to confirm the selected function.

If a function only has one quick-switch option, it is operated by this key. On the display, active settings (ON) are indicated by a “✓” next to the relevant item; inactive settings (OFF) are indicated by a “–” or this space in a line is empty.

Softkey: Esc

Press the **Esc** softkey **briefly** to exit the section of the menu currently displayed. You will then see the selection from the previous menu branch or the current idle or call display. When you navigate within the menu and press and **hold** the **Esc** softkey the menu closes and the telephone returns to the idle state once again.

Softkey: Redial

 Allows you to select a call number from the redial list.

Softkey: Menu

A **long** key press of the **Menu** softkey in the idle state: the main menu is displayed. This menu is where you can make all desired phone settings. The individual menus are explained in the chapter “Main” Menu starting on page 81.

A **short** key press to the **Menu** softkey: depending on the mobile unit state, displays a menu with only relevant operations, i.e. ones that can currently be executed.

Receiver Key



 The receiver key has the same function as “lifting the receiver” or “replacing the receiver” on a conventional telephone.

Speaker/Handsfree Key

 Activates/deactivates the Speaker/Handsfree mode. When Speaker /Handsfree is activated, this key is lit. This key flashes when there is a call. You can accept the call using the loudspeaker key and conduct the call in the handsfree mode.

Info Key

 Use the Info key to access the various lists (e.g. call list) as well as view and change currently activated features (e.g. call blocking, call diversion).

If there are new calls, e-mails, short messages or voicebox messages the Info key flashes. When a short message or e-mail is received, the  symbol appears; when a voicebox message is received, the  symbol.

C Key (Delete Key)

 The C key (also Delete key) has several functions. It depends on the current state of the telephone, e.g. idle state, on a call, in the edit mode etc. and there is a distinction between a **short** or **long** key press. The following functions are available:

... if the device is switched off:

short or **long** key press: device is switched on

... when idle:

long key press: the device is switched off

... during an incoming call:

long key press: the device is switched off

... during the call:

long key press: the device is switched off

... when editing:

- **short** key press: deletes a single character to the left of the cursor
- **long** key press: deletes (after a short notification tone) the entire entry

... when in the lists (e.g. call or redial list):

- **short** key press: deletes the selected entry
- **long** key press: deletes (after a short notification tone) the entire list

... when in menus:



- **short** key press: goes back one menu level
- **long** key press: ends the menu

R Key (Signal Key) / Emergency Call Key

Short key press of the  key during a call: an enquiry is initiated.

Long key press when idle: the previously configured emergency call number (SOS) is dialled. You can enter the emergency call number in the "Telephone Option> Emergency call" menu (see page 93).

Hash Key



Long key press of the  key when idle: switches the keypad lock on. An active keypad lock is displayed with the  symbol in the softkey line. To unlock the keypad, press the softkey under this symbol and then the  key.

Star Key

Long key press of the  key when idle: switches the buzzer/ringer on and off.

Short key press while entering text (e.g. name for phone book entry): switch back and forth between upper and lower case.

Number Keys

The  to  number keys are for entering call numbers, names and vanity call numbers. For information on entering text using the number keys, please refer to the chapter The Editor starting on page 35.

Long key press in call state: opens the local phone book and you can search for a call number, see Editing Local Phone Book Entries of Your Aastra 142d starting on page 80.

Locking Your Telephone Interface by the System Administrator

The system administrator can lock your telephone interface via a setting for your user group. All keys of your telephone no longer function aside from a few exceptions (e.g. the receiver key and the number keys).













- You can still make calls with your telephone but no system functions can be configured.
- The redial function, the communications system telephone books, the Info menu and the state-dependent menus cannot be activated. (These menus are opened by a short press on the **Menu** softkey, they are described in the chapter *Telephoning* starting on page 52.) The personal phone book of the mobile unit is, however, available because the lock only affects communications systems functions.
- If the system administrator has authorised you to do so, you can set the time group of the communications system (please refer to “Central settings” Menu starting on page 102 also). If your user group authorisation changes according to the time group, then it is possible that your telephone’s interface lock will be cancelled due to a change in time group.

Please contact your system administrator if you have questions regarding your authorisations.

The Editor

Using the editor, you can enter or change call numbers and names within lists (e.g. in the phone book). The maximum length when entering characters (call numbers) is 32 characters and when entering letters (names) 16 characters.

In input lines for entering text, the numeric keyboard automatically switches to entry of letters. The following characters can be entered using multiple key press of number keys:

Key	Upper-case letter	Lower-case letter
	! ? 1 - + * / = & () % ¿ ¡	! ? 1 - + * / = & () % ¿ ¡
	A B C 2 Ä Å Á Â Ã Ä Æ Ç	a b c 2 ä å à á â ã æ ç
	D E F 3 È É Ê Ë	d e f 3 è é ê ë
	G H I 4 Ì Í Î Ï	g h i 4 ì í î ï
	J K L 5	j k l 5
	M N O 6 Ñ Ò Ó Ô Õ Ö Ø	m n o 6 ñ ò ó ô õ ö ø
	P Q R S 7 ß	p q r s 7 ß
	T U V 8 Ü Ú Û Ü	t u v 8 ü ú û ü
	W X Y Z 9	w x y z 9
	space , . 0 ; ; _ " ' ^ ~	space , . 0 ; ; _ " ' ^ ~
	Switching upper/lower case	Switching upper/lower case
	# @ € \$ £ ¥ § < > { } [\]	# @ € \$ £ ¥ § < > { } [\]

- When entering text, use the arrow keys to move text input position to the beginning or end of the entry.
- Entries are always made at the cursor position.
- Input position moves automatically forward if you make no entry for a short time or when you enter a new character.
- When entering text, the first letter is automatically upper case and then automatically switched to lower case. After you enter a space, the next letter is upper case.
- When entering text you can switch upper and lower case by pressing a number key **longer**. The upper/lower case remains in effect until the next long key press. You can also press the  star key to switch back and forth between upper and lower case.

- A short press of the C-Key  deletes single numbers/characters (left of the cursor position), a long key press to delete the entire entry.
- The Esc softkey cancels the input procedure.

Menu Navigation

The Main Menu

menu When idle, press the Menu softkey **long**.
 The main menu opens (see also *page 81*).



-  Select an entry via the arrow keys.
- OK Press the OK softkey to call a menu entry. Make the desired settings and entries, then:
- OK / Esc
 - use the OK softkey to confirm a selected function or entry (see also page 32)
 - and/or
 - press the Esc softkey to go back a menu level (see also page 32).

Scrolling

Use the  arrow keys to scroll through menu entries. When you press the **up arrow key** with the first menu entry selected, you go to the last menu entry. When you press the **down arrow key** with the last menu entry selected, you go to the first menu entry.

Switching function

Some functions only offer two settings – ON or OFF. You can tell the function is active (ON) due to ✓. If the function is deactivated, “-” appears in this display line.



Number or arrow key configuration

In the “Ringer settings> Volume” menu, for example, you can use the number keypad or the  arrow keys to set the desired volume (e.g. level 4). After pressing the OK softkey the setting is applied.



Menus Hide Automatically

Menus hide automatically under the following conditions:

- In the idle or call state when you receive a call.
- In the call state when you make entries that require calling up a new call-dependent menu (e.g. the  key was pressed for an enquiry call).
- When pressing a softkey that calls up other menus than the one displayed.
- If you are in a system menu (e.g. communications system phone book) and a caller tries to reach you, the caller hears the busy tone.
- Any open menu closes automatically after 60 seconds if you do not make any further entries. Exception: Playing back a voicebox message which is longer than 1 minute. Unsaved changes are lost.

Any saved entries made in menus remain saved when you exit the menu.

Basic Functions

Device Functions

Switching Device On/Off

You can switch off your mobile unit to make your battery charge last longer. If your mobile unit is switched off, no ringer or info tones are emitted (for example, for an appointment call).

Switching off mobile unit

☞ Press the C key – long key press

Switching on mobile unit

☞ Press the C key – long key press or place the mobile unit on the charging station

The display now looks like this (e.g.):



The communications system is called “OpenCom 100” and the (internal) call number of the mobile unit is “125”. This information refers to the mobile unit of the communications system. The mobile unit is named “Peters”. You can change this information in the “Telephone Option > User Name” menu (see page 93).

The current date and time settings are usually provided by the system when checking in.

Note

When **No Subscription** appears on the display the mobile unit has to be checked in; please refer to [Subscribing Mobile Unit starting on page 22](#).

Key Lock

Activate the key lock before carrying a mobile unit in your pocket. This prevents a call number from being dialled accidentally. When you receive a call, the keylock is deactivated for the duration of the call. Use the ☎ receiver key to accept the call.

Activating keylock

☎ When idle, press the hash key – long key press

When the key lock is activated the display shows: **Key Lock**

Deactivating keylock

Press the ☎ softkey and then the ☎ hash key.

Telephone Lock

Via the “Phone settings > Security > Lock Handset” menu (see page 95) you can switch the telephone lock for the mobile unit on or off after entering your user PIN. Outgoing calls are no longer possible. You may still accept incoming calls. The emergency call key (☎ key) programmed with a call number can still be used. When the key lock is activated the display shows **PIN Lock**. Deactivate the telephone lock by pressing the ☎ softkey and entering your PIN (see page 95).

Speaker/Handsfree Use

Press the ☎ loudspeaker key before or during a call to allow multiple persons to participate in the call. Repeat the process to switch it off. For optimal quality, make sure the mobile unit is upright such that neither the speaker nor the microphone are covered up.



The ☎ key flashes when there is an incoming call. When speaker/handsfree is activated, this key is lit.



Note

When placing the mobile unit into the charging station during a call, handsfree is automatically activated.

Adjusting Volume During a Call

During a call you have 8 levels to adjust the volume of the receiver/headset or the loudspeaker. The setting is shown on the display.

To change the receiver or headset volume, press the  arrow keys; to change the loudspeaker volume, switch the loudspeaker on first and then press the  arrow keys.

Set volume via the  arrow keys or the number keys. Pressing the  arrow keys once raises or lowers the volume by one level.

Note

When the device is idle once again, it reverts to the default setting. You can change this information in the “Phone settings” menu (see page 91).

Setting Volume for Incoming Calls

When you receive a call (and have not accepted it yet), you can temporarily change the ringer volume. Use the  arrow keys to do so. After you accept and end the call, it reverts to the default setting (see page 91).

Switching off Ringer

If you wish to be sure you are not disturbed (e.g. during a meeting) you can switch off the ringer. Incoming calls are then signalled noiselessly via the built-in vibration signal generator (if activated) instead of the ringer. When the acoustical ringer is activated, the  symbol appears on the display.

Switching off Ringer

 When idle, press the star key – long key press

Switching on ringer

 When idle, press the star key – long key press

Alternatively you can switch the ringer on/off via the “Phone settings > Ringer Settings > Device > Buzzer” menu (see page 91).

Muting Mobile Unit

If you do not want the caller to hear, e.g. what you are discussing with someone else in the room, you can temporarily mute your mobile unit.

Muting

Press the  softkey. The person you are speaking with on the telephone can no longer hear you.

Cancel muting

When you wish to talk to the caller again, press the  softkey once again. The caller on the telephone can hear you again.

Changing Display Contrast



To adjust the display to current lighting/brightness conditions, you can change the contrast. You can enter the emergency call number in the “Phone settings > Telephone Option > Disp. contrast” menu (see page 95).

Time/Alarm

When idle the display shows the current communications system time. The time is automatically updated after an external call. After commissioning or after changing the battery it may take a moment until the current time is transmitted from the OpenCom 100 / Aastra 800.

If you have set an alarm (see page 89) the  symbol appears on the display.

Message Display

The  info key flashes when you have messages. When a short message or e-mail is received, the  symbol appears on the display; when a voicebox message is received, the  symbol.

To query these messages, press the  info key **briefly** when idle. For information on how to proceed, please consult the chapter “Info” Menu starting on page 103.

Emergency Call Key (SOS Number)

An emergency call is triggered by a **long key press** of the  emergency call key. You can configure the emergency call number in the “Telephone Option> Emergency call” menu (see page 93). Dialling is immediately executed – i.e. no other key presses necessary.

Connections

Internal and External Call Numbers

Internal and external call numbers for reaching you are assigned during configuration of the OpenCom 100 / Aastra 800 communications system.

Multiple Trunk Keys

Multiple trunk keys can be configured on your telephone (3 max. OpenCom 100 / Aastra 800 communications system). Each of these keys has a separate internal call number which – depending on the system configuration – can also be assigned to a separate external call number. Ask your system administrator about the configuration applicable to you.

When you have multiple trunk keys configured on your telephone, you can dial a call number directly via one of these keys (for direct dialling and pre-dialling please refer to the External/Internal Calling starting on page 52). The first trunk key is designated the preference key if you do not make a selection.

When making a call from the redial list or from the caller lists, the respective trunk key is automatically seized from which the original call was made.

Multiple Connections

Your device can handle two connections simultaneously, i.e. you can speak with two callers at the same time, and switch back and forth between these connections (toggle) or conduct a three-party conference. Any further callers will hear a busy signal.

When the system administrator has configured a call queue, any further calls are given a place in the queue (please refer to the Calls in the Call-Waiting Queue starting on page 46 section).

DTMF Postdial/VF Signalling

Depending on the system configuration, your telephone is automatically set to VF signalling during a call. Use VF signalling, e.g. to query a voice message or voicebox. Please contact your system administrator if you have questions regarding this function.

Charge Display (Charges)

If your network operator transmits charge information – even for external calls you dial yourself – you will see the charge amount for the call during and after the call.

Transmission of Call Numbers

There are various ISDN services which either allow or prevent transmission of call numbers between users.

“CLIP” feature

CLIP is an abbreviation which stands for “Calling Line Identification Presentation”. The call number of the caller is displayed (if transmitted). If the call number has also been entered into the directory of the OpenCom 100 / Aastra 800, the name is displayed.

“CLIP no screening” feature

“CLIP no screening” offers transmission of an arbitrary call number for outgoing connections instead of transmitting the actual call number of the caller. This means that instead of your call number being displayed, e.g. a service call number is displayed to the user you called. The “CLIP no screening” feature must be ordered from the network operator and authorised for use by the system administrator during system configuration. When you receive an external call where the caller is displaying a different call number than the one actually technically being transmitted, a “?” appears next to the call number on the display. If the call number indicated on the display is saved to a phone book entry, the name is displayed as usual along with a question mark.

Note

Display of the question mark “?” is the system default. The system administrator can switch off this default setting in the web configurator with the **Mark unchecked phone number with ?** option (**Telephony: Settings** menu).

“CNIP” feature

CNIP is an abbreviation which stands for “Calling Name Identification Presentation”. In addition to the call number of a caller, the name provided by the caller is transmitted and displayed. This requires that the network operator transmits this information with the connection. If the call number of the caller is also entered into the OpenCom 100 / Aastra 800 directory, this – local – entry is given priority on the display.

“CLIR” feature

CLIP is an abbreviation which stands for “Calling Line Identification Restriction”. Before dialling a call number, you can determine from case to case whether the transmission of your call number is to be suppressed to the person you are calling. Select the “Suppress number” function to do so (see Menu when Idle starting on page 49).

Blocked/Unblocked Call Numbers

Your telephone can be blocked for all or for certain external call numbers. Emergency call numbers (110/112 in Germany) can be placed on a special list – no matter what your external authorisation – and can thus be dialled at any time. Ask your system administrator about it.

Keypad Dialling

Some European network operators require the keypad protocol in order to be able to set features. Depending on the system configuration, your telephone is automatically set to keypad dialling during a call. If not – before dialling – you have to switch your device and enter the codes stipulated by the network operator. These are then directly forwarded to the exchange and evaluated there. You usually receive an announcement in response. Please contact your system administrator if you have questions regarding this function.



Now your telephone has been switched to the keypad protocol. Now you can enter the keypad codes.

Note

This setting is deleted once again when the call is completed!

Least Cost Routing (LCR)

For every outgoing external connection, your system automatically makes a connection – via LCR – to a network operator defined by the system administrator. If you do not use this preferred connection and for a single call would like to select a network operator yourself (call by call), switch LCR off before making the call (please refer to the “LCR off” menu entry in the Menu when Idle starting on page 49 section). This is only necessary if LCR has been configured for you on the OpenCom 100 / Aastra 800. For more information, consult your system administrator.

Note

The baby call and external call forwarding are not automatically conducted via preferred connections. This is where you can prefix the codes of the desired network operator when entering the call number, when you wish to use a different network operator than the standard one.

Calls in the Call-Waiting Queue

The system administrator can additionally configure and activate a **Call-waiting queue** for your telephone in the OpenCom 100 / Aastra 800. While you are making a call, new calls are registered in this queue, the caller first hears an announcement (if your system administrator has configured an announcement) and then the ring tone. The number of calls that can be registered in your queue is defined by the system administrator, e.g. 5 calls. Once this number is reached, any additional callers hear a busy signal. The calls in the queue are transferred in accordance with their priority (baby calls, door calls, VIP calls, other internal and external calls), calls with the same priority are transferred in the order made.

Calls that are in the queue for too long a time are removed. The caller then hears a busy signal also. The time interval until an external call is cleared from the queue is defined by the network operator. This is usually 2 minutes in Germany and in other European countries usually 3 minutes.

Your telephone can have a call-waiting queue even if it belongs to a subscriber group. A call-waiting queue simultaneously affects call forwarding.

Note

If call-waiting protection is activated on your telephone, every time a new call comes in you will hear the call-waiting tone and see on your display whether the call is external or internal. If call-waiting protection is activated and you end the call, the next waiting call will be signalled.

For more information please refer to the “Call Queue” chapter in the “OpenCom 100 Mounting and Commissioning” (or “Aastra 800 Installing and Commissioning” user guide).

Calls with Booking Numbers

By means of a booking number you can record the call data of a connection to an external subscriber and save them in the OpenCom 100 / Aastra 800 for further evaluation. Booking numbers are useful, e.g. for calculating costs per client (fees and times) in an office. Incoming calls can also be associated with a booking number.

Notes on booking numbers

- The system administrator defines the length of the entered booking number during system configuration.
- Entering a booking number during a call is possible only if the system administrator has activated this function for your user group (please refer to Menu during Conversation starting on page 56 also).
- For external connections established by you it is relevant how system administrator has configured the route you are using for the connection. One thing the system administrator defines during configuration is whether a booking number is entered via the menu during a call. He/she can, however, also specify that booking numbers must be entered via code procedure. In that case the booking number must be entered before the call is initiated and the connection is established. It is entered after the routing code and before the actual destination call number.
- The calls made with a booking number can be evaluated with the **OpenCount / Aastra Count** Web application of the OpenCom 100 / Aastra 800 communications system.

Forwarding Calls

Types of forwarding

You can forward internal or external calls intended for yourself to another internal call number or – provided that you have the necessary user group authorisation – to another external call number. Calls can be forwarded either immediately, after a specified period of time or if the terminal is busy. You can configure more than one call forwarding mode at the same time (**Immediately**, **After delay** or **Busy**). You can, e.g. configure call forwarding **Immediately** for external calls to one call number, and call forwarding **After delay** for internal calls to a different call number. During configuration, the system administrator defines an interval in seconds for **After Delay** call forwarding. You can replace this default with your own individual value when programming **After delay** call forwarding. If more than one forwarding mode has been activated, **Immediately** call forwarding is always given priority.

Call forwarding to a voicebox

When **OpenVoice / Aastra Voice**, the integrated Voice-Mail-System, is installed on the communications system, you can also forward calls to your voicebox call number.

Selective Call Forwarding

Furthermore, the system administrator can programme call forwarding where the call number of the caller is evaluated (“SCF: Selective Call Forwarding”). Potentially this could be the reason why specific calls do not reach you. Please contact your system administrator if you have questions regarding this function.

Least Cost Routing

Least Cost Routing (LCR) can be evaluated with call forwarding to external numbers – provided your system administrator has configured LCR and its application in the OpenCom 100 / Aastra 800 correspondingly. Ask your administrator for the configuration applicable to you.

Hunt group call numbers

During system configuration, the system administrator can configure call forwarding destinations for hunt group call numbers. These destinations are called when all users of a hunt group are busy and/or when a call is not accepted by any member of the hunt group within a certain time interval. You cannot view or change this call forwarding on your device.

In addition, the system administrator can determine whether you can forward incoming calls to the hunt group call number or not. If the system administrator does not permit call forwarding for your hunt group call number, any call forwarding that you have programmed on your device is not carried out upon a hunt group call.

Call forwarding chains

The system administrator can configure the system such that multiple call forwarding instances can be linked one to another to form a chain. A simple example: user A forwards to user B, who then forwards to user C. A call for user A is then directly signalled to user C.

A setting in your user group regulates which call number appears on your device when a call which has been forwarded multiple times is signalled on your device: you will see either the call number of the last user who programmed the last call forwarding in the chain, or the call number of the first user in the chain. The number displayed is also saved to the caller list for missed calls on your device.

The system prevents call forwarding chains from forming a loop, e.g. when the call forwarding destination refers back to the call forwarding source. When the system detects a call forwarding loop, no further call forwarding is carried out. This can mean

that – despite call forwarding being programmed – calls are nonetheless signalled on your device.

A loop is also detected during call deflection. If you receive a call via a call forwarding chain and wish to deflect it to a destination call number which is already in the call forwarding chain, a negative acknowledgement tone is heard and the call signalling on your device will continue.

Contact your system administrator if call forwarding is not functioning as expected on your device. The system administrator is able to analyse call forwarding chains and eliminate any possible conflicts.

Menus

Menu Before and During a Call

When the handset is in the idle or call state, state-dependent menus are displayed when you briefly press the **Menu** softkey. Frequently used features are shown which you can activate.

Examples:

1. Another telephone in your pick-up group rings and you want to accept the call. Press the **Menu** softkey briefly, select **Pick-up** and confirm your choice with **OK**. You will be connected with the caller.
2. Or a subscriber is busy and you want to be called back. When you hear the busy signal, press the **Menu** softkey and confirm **Callback** with **Ok**.

The state-dependent menus are individually described at the end of the following chapters.

Menu when Idle

Note

Menu items marked with an * are only displayed if the corresponding user authorisation has been set for your user group in the **OpenCom 100 / Aastra 800 Configurator**. Please contact your system administrator if you have any questions.

When idle, press the **Menu** softkey **briefly** (also possible if you have already pressed the **⊖** receiver key) and then dial...

Un Park: Consecutively “unparks” one or more connections which you have previously parked, for instance to make enquiries or to forward calls (see also Menu during Conversation starting on page 56).

Pick-up:* You accept the call for another telephone in your pick-up group.

Pick-up select:* You accept a call for any other internal caller. Enter the call number of the other telephone. If the other telephone is already in the call state (e.g. an answering machine is making an announcement), you pick up the call. The subscriber for whom you picked up the call must belong to a user group for which “Call removal” authorisation is activated, otherwise “Pick-up select” is not possible.

Note: If the called subscriber is a member of a user group for which pick-up protection is active, “Pick-up” and “Pick-up select” are not possible.

Take: You wish to take a current call from one terminal over to your DECT telephone and continue the call on the DECT telephone. To do so, your DECT telephone and the other terminal must have the same internal call number.

Announcement:* After entering the call number, you can initiate an announcement to another system terminal (or to a group of system terminals).

Intercom:* After entering the device ID, you can initiate an announcement to a single system terminal. The microphone of the terminal called will be switched on and the person you are calling can immediately answer your announcement. The “Intercom” function cannot be used for announcements to a group of terminals.

Charges: Here you see the amount charged for the last call and the total charges for your device.

Door opener:* You activate the door opener.

Notes: Make a note of a call number and a name or dial a notated call number.

Suppress number:* Your call number is not transmitted to the person you call next.

Transmit number:* Your call number is transmitted to the person you call next

LCR off:* You switch off LCR (Least Cost Routing) for the next call.

VIP call:* Your next internal call is executed as a VIP call. Even when the internal subscriber called (with system terminal only) has activated call waiting protection, call protection or call forwarding, your call is signalled acoustically.

Main menu: The Main menu is called, see “Main” Menu starting on page 81.

Telephoning

External/Internal Calling

External Seizure and Entry of Call Numbers

If you hear the external dialling tone after pressing the ☹ receiver key, your telephone is set to **spontaneous** external line seizure. If you hear the internal dialling tone after pressing the ☹ receiver key, your telephone is set to **manual** external line seizure. The external line seizure applicable for you is configured by your system administrator upon user group configuration.

If your telephone is set to **manual** external line seizure, an internal line is seized initially. You can dial an internal call number immediately. You have to use the external line prefix to dial external call numbers (default: "0"). The system administrator defines this code for all users in the OpenCom 100 / Aastra 800 and informs you of the applicable value.

If your telephone is set to **spontaneous** external line seizure, an external line is seized initially. You can dial an external call number immediately. To reach internal users – before entering the internal call number – press the ☹☹ star key twice.





If you dial a call number for an enquiry or when you programme call number destinations, you have to enter these call numbers in accordance with the external line seizure applicable to you.

Example





You wish to programme call forwarding.

- You enter an **external** call number directly with spontaneous line seizure; with manual line seizure, enter the prefix code for the external line (default: "0"). Exception: The destination of "Divert MSN" is always entered without a prefix code.
- Enter an **internal** call number directly with manual line seizure; with spontaneous line seizure, press the ☹☹ star key twice beforehand.



Dialling Directly

-   Press the receiver key and enter the internal or external call number (if necessary with prefixed code for external line seizure, please refer to page 52 also).
 If there are several trunk keys configured on your telephone you can assign them specifically (please refer to page 43):
-  Press receiver key **longer**.
-  Use the arrow keys to select the trunk key desired.
-  Enter internal or external call number.

Pre-dialling

-   Enter entire call number and then press receiver key.
 If there are several trunk keys configured on your telephone you can assign them specifically (please refer to page 43):
-  Enter internal or external call number.
-  Press receiver key **longer**.
-  Use the arrow keys to select the trunk key desired.



Correcting pre-dialling entry:

-  short key press: deletes single characters
-  long key press: deletes entire entry

Redial

The call numbers you last dialled are saved in the redial list (the last entry is first on the list). If the call number is also entered into the communications system phone book, the name appears as well.

Dialling a call number



-  Press softkey (when device is idle).
-  Use the arrow keys to select an entry.
-  Press receiver key. The call number is dialled.

Note

If there are multiple trunk keys configured on your telephone (please refer to the chapter Multiple Trunk Keys starting on page 43 also), when you redial, the trunk key is automatically seized with which you originally dialled the call number.

Additional options:

After you have selected an entry from the redial list, you can instead of dialling – execute the following operations:

-  Press softkey.
-  use the arrow keys to select a menu entry:
 - Dial:** press . The call number is dialled.
 - Delete:** you delete the entry from the list.
 - Phone book:** you can add the entry to the communications system phone book (**New entry**) or add an existing entry (**Add**). Please refer to: Add Phone Numbers from Lists or during Call to Communications System Phone Book starting on page 77.
 - Delete all:** after a confirmation query, this deletes the entire redial list.

Note

If your internal call number (e.g. “30”) is configured on multiple terminals, you can view and edit the redial list for the call number 30 on each of these terminals. If you delete, e.g. the redial list on a terminal, it is then deleted on the other terminals as well.

Calling from the Caller Lists

Your mobile unit saves the call numbers to the caller list of the users that either did not reach you (missed calls) or callers that you most recently spoke with (accepted calls). This requires that the call number was transmitted during the call, please refer to Transmission of Call Numbers starting on page 44 also. A missed call is deleted from the list when a caller reaches you on a subsequent call. If a caller is saved in your phone book, the name is displayed.

If a caller has called multiple times, that caller's calls are listed as one entry. If a caller suppresses display of his/her call number, the call is also saved on the caller list. Multiple calls from an unknown call number are listed as one entry.

If your system administrator has set up a voicebox for you, the caller list also lists the messages callers have left on your voicebox.

Dialling Call Number from Caller List

- ① Press Info key **briefly** when idle.
- ☐ Select **Missed calls** or **Voicebox mess.** menu entry.
(You open the list of accepted calls via the "Calls" menu, please refer to page 84.)
- OK Use the ☐ arrow keys to press the softkey and select an entry.
- ⊖ Press receiver key. The call number is dialled. When you have selected a voicebox message, your voicebox is called and you can query the message there.

Note

If there are multiple trunk keys configured on your telephone (please refer to the chapter Multiple Trunk Keys starting on page 43 also), when you receive a call from the caller list, the trunk key is automatically seized with which you originally received the call number.

Call Waiting with an Internal Subscriber

When you call an internal subscriber whose number is busy, your call will appear on their display and signalled with the call waiting tone. You hear the ringing tone yourself. The system administrator can determine that a special ringing tone is used for call-waiting calls. Based on this special ringing tone, you can decide whether you wish to end the connection or not.

If the subscriber called has activated call-waiting protection (see page 97) you will hear the busy signal. You can penetrate a subscriber's call-waiting protection via a VIP call (see page 58).

Using Routes to Make Calls

The OpenCom 100 / Aastra 800 establishes calls to a desired subscriber either automatically or via specific routes. Your system administrator configures these routes in the OpenCom 100 / Aastra 800 and specifies how each route is seized. In order to manually seize a specific route for a desired call, dial the routing code before dialling the (internal or external) call number. By making specific calls via routes, you can e.g. contact subscribers in the branches of a large company network. It is also possible to use a manually-entered routing code to record your call-charge data for external private and business calls separately.

 enter routing code, dial call number

for enquiry:

 enter routing Code, dial call number

Your system administrator can provide you information on current routes and your codes.

Menu during Conversation

Note

Menu items marked with an * are only displayed if the corresponding user authorisation has been set for your user group in the OpenCom 100 / Aastra 800 **Configurator**. Please contact your system administrator if you have any questions.

You are making a call. Press the **Menu** softkey **briefly** and then dial...

Handsfree on or Handsfree off: you switch handsfree on or off.

Disconnect: you disconnect the connection. The current call is ended and you can dial once again.

Phone book: you can add the call number of the person you are speaking with into the phone book of the OpenCom 100 / Aastra 800 (**New entry**) or add it to an existing entry (**Add**). Please refer to: Add Phone Numbers from Lists or during Call to Communications System Phone Book starting on page 77.

Park call:* you can “park” the caller for some time. Please refer to the chapter Parking Calls starting on page 69 for further information.

Booking number:* The current call (to an external caller) can be designated with a booking number. Enter the booking number (8 digits max.) under **No.** and confirm with the **OK** softkey. Please refer to the chapter Calls with Booking Numbers starting on page 47 for further information.

Pick-up:* You accept the call for another telephone in your pick-up group. Your first call is put on hold. “Pick-up” is not available if there are two connections running already.

Pick-up select:* You accept a call for any other internal caller. Enter the call number of the other telephone. If the other telephone is already in the call state (e.g. an answering machine is making an announcement), you pick up the call. “Pick-up select” is not available if there are two connections running already. The subscriber for whom you picked up the call must belong to a user group for which “Call removal” authorisation is activated, otherwise “Pick-up select” is not possible.

Note: If the called subscriber is a member of a user group for which pick-up protection is active, “Pick-up” and “Pick-up select” are not possible.

Take: You wish to take a current call from one terminal over to your DECT telephone and continue the call on the DECT telephone. To do so, your DECT telephone and the other terminal must have the same internal call number. Your first call is put on hold.

Intercept:* The call numbers of “malicious callers” can be saved in the exchange of the network operator (if this service has been ordered). The function is also possible if the caller has already hung up!

Door opener:* You activate the door opener.

Menu if Subscriber Busy

Note

Menu items marked with an * are only displayed if the corresponding user authorisation has been set for your user group in the OpenCom 100 / Aastra 800 **Configurator**. Please contact your system administrator if you have any questions.

You have dialled a call number and the subscriber is busy. Press the **Menu** softkey **briefly** and then dial...

Disconnect: You disconnect the call and can make another call.

Callback: You leave your callback request with the busy subscriber (please refer to the **Callback** starting on page 68 section also).

Pick-up select:* You pick up a call for any other telephone. Enter the call number of the other telephone. If the other telephone is already in the call state (e.g. an answering machine is making an announcement), you pick up the call. The subscriber for whom you picked up the call must belong to a user group for which "Call removal" authorisation is activated, otherwise "Pick-up select" is not possible.

Note: If the called subscriber is a member of a user group for which pick-up protection is active, "Pick-up select" is not possible.

VIP call:* Even when the internal subscriber called (with system terminal only) has activated call waiting protection, call protection or call forwarding, your call is signalled acoustically.

Door opener:* You activate the door opener.

Menu during the Call

You have dialled a number. Your call is signalled to the subscriber called. The subscriber called has not yet accepted the call. Press the **Menu** softkey **briefly** and then dial...

Disconnect: You disconnect the call and can make another call.

Door opener: You activate the door opener. (this menu entry is only available to you with the appropriate user authorisation).

Ending a Call

End a call as follows

- ⊖ Press receiver key **briefly** or
- Menu press softkey **briefly**.
- ⏪ Use the arrow keys to select the **Disconnect** menu entry.
- OK Press softkey to confirm.

If the subscriber you are speaking to ends the call, the busy signal for your telephone is switched off after a few seconds and you can be reached again. This also applies when you are connected via headset. The time interval until the busy signal is switched off is configured by the system administrator. All other connections are ended after 20 seconds when the receiver is not replaced.

Accepting Calls

Optical Call Display

When there is an incoming call, the  receiver symbol flashes on the display and the display illumination is switched on.

Temporarily Switching off Call Signalling

While a call is being signalled on your telephone via ringer and/or vibrator, you can switch off signalling temporarily. Press the **Silence** softkey. You can still accept the call as described on page 59.

Normal Call

When you are called, the caller's call number is displayed (if transmitted). If this call number is also recorded in your phone book, you will see the person's name instead.

- ⊖ Press receiver key
- or – when “Auto answer” is activated (see page 94) – remove the mobile unit from the charging station.

Call for a virtual call number (Tele Secretary)

Call numbers not assigned to any telephone or user (virtual call numbers) can be configured on the OpenCom 100 / Aastra 800. The system administrator can divert a virtual call number to another internal call number, e.g. the call number of your telephone. This kind of diverted call is signalled on your telephone just like a normal call.

External calls from unknown call number

When you receive an external call where the caller is displaying a different call number than the one actually technically being transmitted (CLIP no screening), a “?” appears next to the call number on the display. If the call number indicated on the display is saved to a phone book entry, the name is displayed as usual along with a question mark. Note: Display of the “?” can be deactivated by the system administrator.



VIP Calls

VIP calls from authorised users are signalled to you even when call protection, call waiting protection are activated or call forwarding is programmed. You hear the melody (please refer to the “Melody” section also on page 90) and see the entry **VIP call** along with the caller’s call number on the display.

Accept the call just like a normal call (see page 59).

Calls during a Conversation

While you are making a call, any incoming calls are signalled acoustically as well as visually on the display (“Call Waiting”). Call waiting protection must be deactivated for this to happen (see page 97).

-  You are making a call, hear the call waiting tone and see the text “Call waiting” as well as the name or call number of the subscriber waiting on the display.
-  Press the receiver key to end the current call. The call waiting call is now signalled to you just like a normal call.

or
-  Press softkey **briefly** to accept the call waiting call. Your first call is placed on hold. You are speaking with the call waiting caller.

For further information, please refer to the chapter Enquiry, Toggling, Transfer and Conference starting on page 62.

Incoming Call Menu

You receive an incoming call, the telephone is in the idle state. Press the **Menu** softkey **briefly** and then dial...

Reject call: Reject the call by pressing the **OK** softkey. The caller hears the busy signal.

Deflect call: You do not accept the call yourself, rather deflect it to another subscriber. Enter the call number of this subscriber under **To:** and then press the **OK** softkey. You can only use the “Deflect call” function if your user group has the authorisation to deflect to internal and/or external destinations.

Door opener: You activate the door opener. (this menu entry is only available to you with the appropriate user authorisation).

Call Waiting Menu

Note

Menu items marked with an * are only displayed if the corresponding user authorisation has been set for your user group in the OpenCom 100 / Aastra 800 **Configurator**. Please contact your system administrator if you have any questions.

You are making a call and receive a call. Press the **Menu** softkey **briefly** and then dial...

Hands-free on or **Hands-free off:** You switch the handsfree mode on or off.

Disconnect: You disconnect the current call and accept the call-waiting call.

Phone book: you can add the call number of the person you are speaking with into the phone book of the OpenCom 100 / Aastra 800 (**New entry**) or add it to an existing entry (**Add**). Please refer to: Add Phone Numbers from Lists or during Call to Communications System Phone Book starting on page 77.

Park call:* You park the first call. Then press the **⊖** receiver key to enable your telephone to accept calls. The call-waiting call will then be signalled like a normal call. Press the **⊖** receiver key and you are connected with the call-waiting subscriber. After you have finished this call you can “unpark” the parked call by briefly pressing the **Menu** softkey. Please refer to the chapter Parking Calls starting on page 69 for further information on this function.

Reject: Reject the call-waiting call by pressing the **OK** softkey. The caller hears the busy signal.

Accept: Accept the call by pressing the  softkey. The connection to the original subscriber is held in enquiry. You can now toggle back and forth between the two callers (please refer to the chapter Enquiry, Toggling, Transfer and Conference starting on page 62 also).







Deflect:* You do not accept the call yourself, rather deflect it to another subscriber. Enter the call number of this subscriber under **To:** and then press the  softkey. You can only use the “Deflect” function if your user group has the authorisation to deflect to internal and/or external destinations.

Door opener:* You activate the door opener.

Enquiry, Toggling, Transfer and Conference

Enquiry/Toggle via the R (Signal) Key



During a call you can consult another subscriber.

-  You are making a call.
Initiate enquiry:
-  Press R key **briefly**. Your first call is placed on hold.
-  Enter internal or external call number. Note the type of line seizure (see page 52).
-  You are speaking with the subscriber called.
For toggling (switching back and forth between callers):
-  Press R key **briefly**.
Ending toggling/enquiry:
- Menu Press softkey **briefly**.
-  Use the arrow keys to select the **Disconnect** menu entry. The current call is ended.
-  Press R key **briefly**. You are speaking with the waiting subscriber once again.

Transferring an Internal/External Call to an Internal Subscriber

You have dialled an internal enquiry call (see page 62).

The subscriber called via enquiry answers:

-  Announce the call transfer.
-  Press receiver key **briefly**.



The subscriber called via enquiry does not answer or is busy:

-  Press receiver key **briefly**. The other subscriber is called.

If the called subscriber accepts the call, he/she will be connected to the waiting call. If the call is not accepted within a certain time interval (the communications system is 45 seconds by default, the system administrator can change this value), you get an automatic recall. After pressing the  receiver key you are connected with the original subscriber once again.

If the system administrator has configured the **Music on hold upon transfer on calling** feature in the **Configurator**, the caller on hold hears “Music on Hold” while his/her call is signalled to the other internal subscriber. This setting also determines whether, when calling back, the caller hears “Music on Hold” or a ringing tone or busy signal.

Use the following procedure to disconnect an enquiry connection (e. g. when the subscriber called is busy):

- Menu Press softkey **briefly**.
-  Use the arrow keys to select and confirm the **Disconnect** menu entry.
- OK Press softkey to confirm.
-  Enter another internal call number to transfer the call.
- or
-  Press R key **briefly**. You are speaking with the waiting subscriber once again.

Transferring an External Call to an External Subscriber

External calls can only be transferred to an external subscriber via the caller on hold menu (see page 64).

- | | |
|--|--|
| Menu | Press softkey briefly . |
|  | Use the arrow keys to select the Transfer menu entry. |
| OK | Press softkey to confirm transfer. |

Depending on your communications system's settings, the external calls will be switched together on your communications system or on the exchange of your network operator.

Note

When you call an external party and then transfer this person to another external party, you will bear the costs for the call between the two external callers. You have no way of influencing how long the transferred call will last. The connection is established via the OpenCom 100 / Aastra 800 and occupies two call channels (ISDN user channels).

Menu when Subscriber on Hold

Note

Menu items marked with an * are only displayed if the corresponding user authorisation has been set for your user group in the OpenCom 100 / Aastra 800 **Configurator**. Please contact your system administrator if you have any questions.

You have put a call on hold and are making an enquiry call. Press the **Menu** softkey **briefly** and then dial...

Hands-free on or **Hands-free off**: You switch hands-free on or off.

Disconnect: You disconnect the current connection. You can now either enter a new call number for another enquiry. Or you press the  key **briefly** and are once again connected with the caller on hold.

Phone book: you can add the call number of the person you are speaking with into the phone book of the OpenCom 100 / Aastra 800 (**New entry**) or add it to an existing entry (**Add**). Please refer to: Add Phone Numbers from Lists or during Call to Communications System Phone Book starting on page 77.

Park call: * You can “park” the current caller. Please refer to the chapter Parking Calls starting on page 69 for further information on this function.

Booking number:* The current call (to an external caller) can be designated with a booking number. Enter the booking number (8 digits max.) under **No.** and confirm with the  softkey. Please refer to the chapter Calls with Booking Numbers starting on page 47 for further information on this function.

Call Diversion (diversion): You put your current caller on hold (called via enquiry) and then call another subscriber with whom you wish to connect your current caller. Enter the call number of the subscriber you wish to transfer, announce the call to that caller and press the  receiver key. The call has now been transferred. After transfer, you are reconnected with the caller you originally put on hold.

Transfer:* You connect the subscriber on hold with the current caller you are speaking with.

Conference:* You initiate a 3-party conference.

Toggle: You toggle between the current subscriber and the subscriber you last spoke with.

Door opener:* You activate the door opener.

Three-Party Conference

If your user group has the corresponding authorisation configured, you can conduct a telephone conference (maximum of 3 subscribers). Conference participants can be internal or external callers. Three-party conferences cannot be connected.

Initiate and end conference

Initiate conference:

 **briefly** Establish enquiry connection (see page 62).

 When the subscriber answers, announce the conference.

Menu Press softkey **briefly**.

 Use the arrow keys to select the **Conference** menu entry. The conference is initiated.

Ending conference:

 Press receiver key **briefly**.

or



Menu Press softkey **briefly**.

 Use the arrow keys to select the **End conference** menu entry.



Disconnecting Conference Participants

During a conference, you can once again speak to conference participants separately or exclude individuals.

Menu Press softkey **briefly**.

 Use the arrow keys to select the **Disconnect** menu entry (e.g. **Disconnect 034565483** for the subscriber with the call number “034565483”) and confirm with the  softkey. The subscriber is disconnected from the conference and you continue the call with the other subscriber.

or:

Select the **Toggle** menu entry and confirm with the  softkey. The connections to both callers are held and you can toggle between them both using the  key.

Menu During the Conference

Note

Menu items marked with an * are only displayed if the corresponding user authorisation has been set for your user group in the OpenCom 100 / Aastra 800 **Configurator**. Please contact your system administrator if you have any questions.

You are in a three-way conference. Press the **Menu** softkey **briefly** and then dial...

Hands-free on or **Hands-free off**: You switch hands-free on or off.

Disconnect (e.g. **Disconnect 034565483**): You disconnect the caller with the call number 034565483 from the conference (in this example, an external caller) and continue the call with the other caller.

Phone book: you can add the call number of the person you are speaking with into the phone book of the OpenCom 100 / Aastra 800 (**New entry**) or add it to an existing entry (**Add**). Please refer to: Add Phone Numbers from Lists or during Call to Communications System Phone Book starting on page 77.

Park call:* You “park” the caller to whom you had established an enquiry connection before you initiated the conference (please refer to Parking Calls starting on page 69 also). The conference is thus ended.

Booking number:* When you call an external subscriber and have included the person in the conference, you can assign a booking number to the call data of this connection. Enter the booking number (8 digits max.) under **No.** and confirm with the **OK** softkey. Please refer to the Calls with Booking Numbers starting on page 47 chapter for further information on this function.

Transfer:* You switch yourself out of the conference. The other subscribers remain connected.

End conference: You end the conference.

Toggle: You end the conference and can now toggle back and forth between the participants.

Door opener:* You activate the door opener.

Special Calls/Conversations

Callback



If you call another subscriber of your OpenCom 100 / Aastra 800 communications system and the line is busy, you can initiate automatic callback. Your user group must have authorisation for this feature to be able to use it.

Initiate callback

- Menu Press softkey **briefly**.
-  Use the arrow keys to select the **Callback** menu entry.
- OK Press softkey to confirm.

Answering a callback

A callback is carried out when the other subscriber is free.

-  When your telephone rings,
 press receiver key.
The other subscriber is now called.

Accepting an Appointment Call

You can save two appointments on your mobile unit (please refer to page 88). When the appointment time occurs, your mobile unit rings for a period of one minute with volume increasing. The appointment number appears on the display. An appointment can be repeated once or repeatedly.

Accepting an Appointment Call

-  Press receiver key. The reason for the programmed appointment appears.
- OK Press softkey to confirm the appointment call.

If you are on a call at the time of the appointment call, you will hear a special tone and the display indicates the appointment number. After you finish the call, a short message informs you that the appointment expired.

Note

You can also programme an alarm on your mobile unit (see page 89). An alarm is signalled once at the programmed time and in contrast to the appointment call, is programmed without indicating a reason.

Baby Call

The “Baby call” function dials a previously programmed internal or external call number after a specific time interval after pressing the  receiver key (please refer to page 96). The default time interval on the communications system is 5 seconds. The system administrator can change this value. If you begin dialling a call number within the specified time interval, the baby call is cancelled.

Carrying out a baby call

Press receiver key.

Note

You can also programme an emergency call number on your mobile unit (see page 93). In contrast to the baby call, an emergency call is triggered with the  key and executed immediately (please refer to page 42 also).



Parking Calls

While calling, you can “park” (one or more) callers for some time and meanwhile conduct other telephone calls or also hang up and carry out other operations. Parked calls are recorded on a list. You can remove calls from the list in any order such that a call is specifically “unparked” once again. The caller hears music on hold – if music on hold has been configured – until the call is “unparked”. If the caller is not “unparked” after some time, a callback is automatically made to your mobile unit as soon as your device is free again. The caller is then automatically “unparked”. If you are, however, still on another call, the caller hears the busy signal and is thus “unparked”. The authorisation for parking connections and the time interval until which callback takes place, is configured by the system administrator upon system configuration.

Park call



 You are making a call.

Menu Press softkey **briefly**.

 Use the arrow keys to select the **Park call** menu entry and confirm with the  softkey. The system offers the next available parking spot (0-9, * or #). Confirm with the  softkey.

Unpark call

Menu Press softkey **briefly** when idle.

 Use the arrow keys to select the **Unpark call** menu entry and confirm with the  softkey. Select the parked call desired from the list offered. Confirm with the  softkey.

 You will be connected with the parked caller.



Announcements (with and without Intercom)

Announcements can be set up on single or multiple system terminals. The “Announcement” function is available in two versions.



- **Announcement with intercom:** The microphone of the system terminal called will be switched on (handsfree operation) and the person you are calling can immediately answer your announcement. An announcement with intercom can only be conducted to a single system terminal (not a group of terminals).
- **Announcement without intercom:** The called subscriber hears a special information tone followed by your announcement. You can also make an announcement to a group of system terminals (e.g. to a hunt group number on which calls are signalled simultaneously). All subscribers called hear the announcement at the same time in this case. The person initiating the announcement hears a signal tone on his/her telephone when the (announcement) connection has been established to all called subscribers. If one of these subscribers replies to the announcement, the announcement call to the other system terminals is terminated.

The system administrator has to extend the corresponding authorisation for your user group for you to be able to use the function. If a subscriber being called has activated announcement protection or intercom protection, announcements to that subscriber's call number will not be carried out.

Making an announcement without intercom

- Menu Press softkey **briefly**.
-  Use the arrow keys to select the **Announcement** menu entry.
-  **To:** Enter the call number (of a single terminal or of a group of terminals).
- OK Press softkey to confirm. State your announcement.



Making an announcement with intercom

- Menu Press softkey **briefly**.
-  Use the arrow keys to select the **Intercom** menu entry.
-  **Device-ID:** Enter device ID of the terminal. Your system administrator can provide you with the device ID.
- OK Press softkey to confirm. State your announcement.

Responding to an announcement (Announcement without Intercom)

That function requires that your user group has to have "Announcement accept" authorisation granted by your system administrator.

If you receive an announcement yourself, you will hear a special information tone. The notification text **Announcement** and the caller's name appear on the display.

-  Press the receiver key to answer the announcement.
alternatively:
- Menu Press softkey **briefly**.
-  Use the arrow keys to select the **Accept** menu entry and confirm with the **Ok** softkey.

or:

Select the **Reject** menu entry and confirm with the **OK** softkey. The announcement initiator then hears the busy signal.

Responding to an announcement (Announcement without Intercom)

Your telephone switches to the handsfree mode when it receives the announcement. You can speak with the caller immediately.

When you have activated announcement protection (see page 96) and/or intercom protection (see page 97) on your mobile device, announcements to your call number will not be carried out.

Doorbell, Door Opener

A doorbell appears on the display (**Door call**). If there is an entry in the phone book for the call number, the doorbell name appears.

Opening door while idle

 Press receiver key

or

Menu press softkey **briefly**.

 Use the arrow keys to select the **Door opener** menu entry and confirm with the **OK** softkey.

Opening door during call

 If the doorbell signal is triggered during a call, you hear the call-waiting tone.

Menu Press softkey **briefly**.

 Use the arrow keys to select the **Door opener** menu entry and confirm with the **OK** softkey.

Note

The **Door opener** menu entry is not dependent on an entrance intercom call. The door opener function controls a relay contact in your system which can also be connected to other devices. For more information, consult your system administrator.

Entrance Intercom Calls**Calling the entrance intercom**

If your OpenCom 100 communications system is connected to an entrance intercom (doorstation 6-wire), you can speak with a visitor at the entrance intercom with the following code procedure.

☎ * 1 0 1

for enquiry:

☎ R * 1 0 1

If you are operating an entrance intercom (doorstation 2-wire, e. g. of the “DoorLine” type), use the following code procedure:

☎ * 1 0 2

for enquiry:

☎ R * 1 0 2

Calling door when idle

Press the ☎ receiver key. You speak with the visitor.

Door call during call

If the doorbell signal is triggered during a call, you hear the call-waiting tone. Proceed as described under Opening door during call starting on page 72.

Door call forwarding

You can forward calls signalled from the doorbell to another (internal or external) call number (a so-called “pharmacy line”). This is done via the **Call forwarding** menu (see page 85).

Call duration

All door calls are automatically terminated after a specific time interval has expired (default is 60 seconds). This ensures that forwarded door calls do not unintentionally

lead to continuous calls (e.g. to a voicebox). Your system administrator can configure the time interval in the OpenCom 100 from 30 to 300 seconds and will be able to tell you the current value.

Voicebox Queries

OpenVoice / Aastra Voice is the integrated voicebox system for the OpenCom 100 / Aastra 800 communications system. This programme enables callers to leave messages for you even for those occasions when you are not reachable.

If the system administrator has configured a voicebox for you, the ⓘ Info key flashes when there are new voicebox messages for you. The 📞 symbol will also appear on the display. To query the voicebox:

- ① Press info key **briefly**.
- or
- 🗨️ **Long** key press of number key 1.
- ☐ Use the arrow keys to select the **Voice Message** menu entry and confirm with the OK softkey. A list of voicebox messages received appears.
- ☐ Use the arrow keys to select one of the entries displayed and confirm with the OK softkey. You can now listen to the message and edit it (please refer to the “Voiceboxmess.” section as of page 84).

Additional options

It is possible to programme call forwarding to the voicebox (please refer to “Call forwarding” Menu starting on page 85).

You can also query your voicebox messages by directly calling the (call number of your) voicebox. You can also use the **Voicebox** menu entry in the **Applications** menu (see page 102).

For detailed information, please refer to the user guide for the additional programme **OpenVoice / Aastra Voice**.

Phone Book

Communications System Phone Books

Up to 2,000 entries can be saved in the phone book of your OpenCom 100 / Aastra 800 communications system. This number includes the centrally administered phone book (available to all users), the personal entries of all subscribers, and – provided you are using the multicompartment variant of the OpenCom 100 / Aastra 800 – the entries in the companies' phone books.

The number of entries you can save in your personal phone book is determined by your system administrator when configuring the OpenCom 100 / Aastra 800. Your personal entries are automatically sorted into the comprehensive register, but can only be viewed on your telephone by you yourself. However, the system administrator or a person with the corresponding authorisation can completely delete your phone book.

Note

The OpenCom 100 / Aastra 800 phone books can also be edited from the system Web console, provided you have the authorisation to do so from the system administrator. Contact your system administrator for information on your authorisations.

Please refer to the chapter "Phone book" Menu starting on page 100 for information on editing communications system phone books.

Calling from the Communications System Phone Book

Search the **Phone book** menu for entries saved to the communications system phone books.

The entries in the phone books of the communication system can be saved within the system itself or in an external address directory (LDAP server, configured by the system administrator). A combination of these storage locations is also possible. The storage locations of phone book entries do affect phone book searching (see following description).

 Press **up arrow key briefly** when idle. The **Directory** menu and the **Name:** menu entry appear.

If you now press the  softkey, the complete list of phone book entries stored on the communications system is displayed. The list is sorted alphabetically and you can page to the desired entry.

 Alternatively: Enter letter/name you are searching for (see The Editor starting on page 35).

 Press softkey

The list of phone book entries found is displayed. All suitable search results are displayed, no matter where they are stored.



 Use the arrow keys to select the desired name.

 Press softkey.

If there is more than one call number under this name (e.g. an office number and a mobile number), the list contains correspondingly designated entries (**Office**, **Mobile** and **Private**).

 Use the arrow keys to select the desired call number.

 Press receiver key – the call number is dialled –
optional:

When there are multiple trunk keys configured on your telephone (please refer to page 43), use the  arrow keys to select the desired trunk key and then press the  receiver key.

or





 Press softkey.

A selection menu appears where you can dial this call number (**Dial** menu entry) or view information on this phone book entry (**Info** menu entry).







Speed-Dialling

All central phone book entries can also be dialled via two-digit or 3-digit speed-dialling numbers once they have been configured. The 2-digit speed-dialling numbers are in the range 00...99, the 3-digit are in the range 000...999. Ask your system administrator how many digits are valid.

Dialling a speed-dialling destination

    (speed-dialling destination)

alternatively:

     (speed-dialling destination) 

Note

Once you have opened the phone book, you can also press the  star key instead of entering a name and enter the speed-dialling number to find the associated phone book entry.

Add Phone Numbers from Lists or during Call to Communications System Phone Book



You can add phone numbers saved in your caller list or your redial list to a phone book (see “Calls” Menu starting on page 82 and Redial starting on page 53). You can also add a call number to the phone book while making a call.







Select the **Phone book** menu entry.

New entry: You add the call number to a phone book (see page 77).

Add: You add the call number to an existing phone book entry (see page 78).



Adding call number as new phone book entry









-  and **OK** Select the **New entry** menu entry in the **Phone book** menu, confirm with the **OK** softkey.
-  and **OK** Select phone book desired: **Personal**, **Company** or **Central**, confirm with **OK** softkey.
-  and **OK** Determine call number: **No. office**, **No. mobile**, **No. private**, confirm with **OK** softkey.

-  and **OK** Enter **Name** and **First name** (see The Editor starting on page 35), confirm respectively with the **OK** softkey.
-  and **OK** Confirm or change the displayed call number, e.g. **No. office**, confirm with **OK** softkey.
- You can assign a speed-dialling number to the call numbers of the entry in the central phone book. You automatically have the next available speed-dialling number (**Abbrev. no.**) offered to you. If you wish to assign them, press the **OK** softkey. If not, delete the speed-dialling number with the  key (enter another unused speed-dialling number if needed) and then press **OK**.
-  and **OK** Display your own call number, confirm with **OK** softkey:
- Transmit number:** When calling (from the phone book) your call number is displayed to the subscriber called.
- Suppress number:** Your call number is suppressed.
-  and **OK** If necessary – as done in the two previous steps – enter additional call numbers (**No. mobile** and **No. private**), confirm respectively with **OK** softkey.
-  and **OK** Dial default number (**Default office**, **Default mobile** or **Default private**), confirm with **OK** softkey. The phone book entry is saved.
- The default call number is dialled automatically if no other call number is selected before establishing a connection.

Adding call number to a phone book entry

You can add the entry to your personal phone book. If your system administrator has authorised you (or the user group you are part of) accordingly, you can also edit the central phone book and your company's phone book.

-  and **OK** Select the **New entry** menu entry in the **Phone book** menu, confirm with the **OK** softkey.
-  and **OK** Select phone book desired: **Personal**, **Company** or **Central**, confirm with **OK** softkey.

-  Enter letter/name you are searching for (see The Editor starting on page 35).
-  Press softkey.
You see the phone book list beginning with the characters entered. If you do not enter any characters and press , the list will begin with the first entry.
-  and  Use arrow keys to select the name desired, confirm with  softkey.
-  and  Select the call number that the list entry is to be saved under: **No. office, No. mobile, No. private**, confirm with  softkey.





Note

If you wish to edit phone book entries (e.g. to change names and call numbers), use the "Phone book" menu (see "Phone book" Menu starting on page 100).



The Local Phone Book of Your Aastra 142d

In addition to the phone book of your OpenCom 100 / Aastra 800 communications system, your Aastra 142d also has a local phone book. You can save additional personal entries in this phone book. When using a MEM card (see Aastra 142d with MEM Card starting on page 20), these are saved on the card.

Calling from the Local Phone Book of Your Aastra 142d

-  Press **down arrow key briefly** when idle. Select the **Search** menu entry.
-  Enter letter/name you are searching for (see The Editor starting on page 35).
-  Use the arrow keys to select the desired name.
-  Press receiver key. The call number is dialed.

Editing Local Phone Book Entries of Your Aastra 142d

-  Press **down arrow key briefly** when idle. Select the **Search** menu entry and if necessary
-  Enter letter/name you are searching for (see The Editor starting on page 35).
-  Use the arrow keys to select the desired entry.
- Options** Press softkey. The local phone book menu appears (see following section).

Local phone book menu

New: You create a new entry. Enter the call number first and then the name. Use **OK** to save.

Edit: You edit a selected entry. Use **OK** to save.

Add To: The entry is added to pre-dialling. This is where you can edit the entry, e.g. to add additional digits when re-dialling an extension.

Quick call: Selected phone book entries can be assigned speed-dialling (1...9). The programmed speed dial is displayed to the right of the phone book entry. When the mobile unit is idle, the local phone book entry can be displayed as pre-dialling by pressing and holding the speed-dialling number (1...9 key) and then dialled with the  receiver key.

Delete: You delete a selected entry (after a confirmation query).

Features and Menus

How to Set Features





There are different ways to set the features of your telephone and of the system:

Using Menus

Use the mobile unit menus to conveniently make settings on the desired features (please refer to Menu Navigation starting on page 37 also).



Some menu entries are only shown on your telephone when you belong to a user group authorised to use the corresponding feature. Contact the system administrator when you have questions on specific features or are not able to use a feature satisfactorily.

Using code number procedures

Many features can also be configured by entering code numbers. Code numbers are entered via the  and  keys respectively and in combination with a specific series of numbers ( to  keys).

Code number input is especially intended for analogue terminals on your system. Code numbers can also be used on your mobile unit. They are described in the short user guide “Code-number Procedures” (this is supplied with the system). A current online overview on the **Codes** entry is available anytime in the **System Info** menu of the OpenCom 100 / Aastra 800 communications system Web console.

“Main” Menu

This menu contains all available features. Some of the menu items can be found in other state-dependent menus as well. For example, received e-mails are available in the Main menu under **Messages** and also available via the  Info key. Features which affect your telephone’s reachability (e.g. call protection activated) are located in the Main menu and also in the **Active Features** menu which you can access via long key press of the  Info key.

Press the **Menu** softkey **longer** or, if the telephone is idle, press the **Menu** softkey **briefly** and select the **Main menu** menu entry. This displays the primary menu groups...

Calls: This contains the most important features relevant to a call.

Call forwarding: This menu group contains all types of call forwarding that you can program on your telephone. Please note the explanations in the chapter Forwarding Calls starting on page 47 also.

Messages: This menu group provides information about short messages and emails that you have received and sent. Furthermore, you can programme appointment calls and activate prepared notification texts.

Phone settings: In this menu group you can configure your telephone to meet your personal requirements (e. g. volume, ringer settings, key lock and display language).

Protection: Among other things, you can activate the call protection, the telephone lock or the user PIN.

Connections: This menu group provides you with all the features that can affect a call. Depending on the particular state, these features are also displayed in the menus that you can access during a call.

Phone book: You can edit the communications system phone books in this menu group.



Applications: This menu group contains all functions offered by your system telephone in conjunction with additional programmes of your communications system. If your system administrator has set up, e.g. a voicebox with the **OpenVoice / Aastra Voice** addition programme for you, this is where you can access and configure your voicebox.

Central settings: This is where you can configure central settings for the communications system. This is an optional menu item, it is only available if your system administrator has configured the appropriate authorisation for your user group.



“Calls” Menu

Select **Call lists** and then select...

Missed calls: Here you can see the call numbers of callers who most recently have tried to reach you. The name is displayed instead of the call number if the caller is in the system phone book. This also applies to calls transferred or forwarded to you from other internal subscribers.

- The  symbol indicates forwarded calls.
- A call when busy is indicated by the  symbol.
- When you receive an external call where the caller is displaying a different call number than the one actually technically being transmitted, a “?” appears next to the call number on the display. Note: Display of the “?” can be deactivated by the system administrator.
- If the call number indicated on the display is saved to a phone book entry, the name is displayed as usual along with a question mark.
- Door calls are shown either with the call number, or with the name of the doorbell – depending on the type of door intercom in use.
- If a caller suppresses display of his/her call number via CLIR, the call is also saved on the call list. Multiple calls from an unknown call number are listed as one entry. The system administrator can, however, during system configuration, determine that any calls with unknown call numbers will not be included on your call list.

The authorisations of your user group determine which calls are recorded on your call list. Your system administrator can specify that internal calls, external calls, calls when busy, and calls from the door be included on your call list.

Select an entry. You can call back the caller directly by pressing the  receiver key. Alternatively, press the  softkey and then select one of the following options:

Dial: Call the caller back.

Delete: The entry is deleted. (an entry is automatically deleted when you have called the caller back)

Phone book: You add the entry to one of the phone books (please refer to Add Phone Numbers from Lists or during Call to Communications System Phone Book starting on page 77).

Info: This displays the call number or name of the caller, time of the last call and the number of calls.

Delete all: You delete all entries from the call list.

Note: If your internal call number (e.g. “30”) is configured on multiple terminals, you can view and edit the list of calls for the call number 30 on each of these terminals. If you delete the call list from one terminal, it will be deleted from all others as well.

Accepted calls: You see the call numbers or the names of the callers with whom you last spoke. You can edit this list in the same way as the missed calls list (see page 82).

Voicebox mess. (voicebox messages): A list of voicebox messages received appears. Each message is identified by the caller's call number or (if saved in the phone book) by the caller's name. Messages that have not yet been played back are marked with a "+"; messages that have been played back are marked by a "-". The most recently received messages are at the top of the list.

Select a message, press the  softkey and then select one of the following options.

Play: Listen to the message the caller recorded. You can also use the number keys to control message playback: **4** (rewind), **5** (pause) and **6** (fast forward).

Dial: Call the caller back.

Delete: The message will be deleted.

Phone book: You can add the caller's call number to one of the phone books (please refer to Add Phone Numbers from Lists or during Call to Communications System Phone Book starting on page 77).

Forward: Forward the message to another voicebox with or without a comment. Enter the call number of the other voicebox under **To:**; use the  star key to end a spoken comment.

Mark as new: If the message is addressed to another person and you accidentally have listened to it, you can use this option to reset the message to "new" status.

Info: To view the call number or name of the caller, as well as the duration, date and time of the message.

Delete all: You delete all messages stored in your voicebox.

Note: The options for editing a voicebox message are only executed if a voicebox has been activated (in the **Configurator** of the OpenCom 100 / Aastra 800, **OpenVoice** / **Aastra Voice: Voiceboxes** menu).

Charges: Here you see the amount charged for the last call and the total charges for your device. If there are multiple trunk keys configured on your telephone, you can view the individual charges for each of these keys. To do so, select the desired key (e.g. **L1: [internal call number]**) and then press the **OK** softkey.

Remote charges: You can view the charges of other OpenCom 100 / Aastra 800 users. To do so, your user group has to have “Costs” authorisation granted by your system administrator. Enter the internal call number of the other user. You can also select a call number from the phone book.

Hunt group: If your telephone belongs to one or more hunt group(s), you can use this menu entry to switch hunt group signalling for your telephone on or off. When there are multiple trunk keys configured on your telephone and assigned to hunt group call numbers, you can switch the hunt group signalling for each of these keys on or off. To do so, select the desired key (e.g. **L1: [internal call number]**) and then press the **OK** softkey.

HG no.: [internal call number]: The pick-list of hunt group call numbers appears. Activated hunt group calls have a “+” prefixing the hunt group call number; deactivated ones have a “-”. You can switch signalling of hunt group calls to your telephone for the call number dialled using the **On/Off** options. Use the **All** menu entry to switch signalling of all hunt group calls on or off for your telephone or for the trunk key selected (**On/Off**).

Note: If you are the last reachable member of the hunt group and you log out then any further callers will hear a busy signal. Depending on the system configuration, additional callers can also be forwarded to the exchange.

Device busy: If there are multiple trunk keys configured on your telephone, you can configure that as soon as one of the trunk keys is occupied your device is considered busy. Any further callers hear the busy signal.

On/Off: Switching function on or off. A “+” appears to designate the function is activated.

“Call forwarding” Menu

Select one of the following menu entries in the **Call forwarding** menu...

Call diversion: Programming call diversions for your own telephone. If there are multiple trunk keys configured on your telephone, you can programme call diversions for each of these keys. To do so, select the desired key (e.g. **L1:**

[**internal call number**]) and then press the  softkey. Select the desired forwarding type: **Immediately**, **After Delay** or **Busy**. Then enter the call forwarding **Dest** (destination) (for information on entering the call number please refer to the chapter External Seizure and Entry of Call Numbers starting on page 52 also). **Time**: When programming call forwarding after delay, you enter the time in seconds after which a call is to be forwarded (10 ... 120 seconds). If you do not enter a value, the default time interval provided by the system administrator at system configuration is used (default: 20 seconds). Then you select whether only internal calls, only external calls or all calls are to be forwarded to the destination. Activate the call forwarding with the **On** option. Active call forwarding is indicated by a "+" sign. This is followed by the call forwarding destination.

Note: All calls for the call numbers of your device are forwarded (exception: hunt group call numbers). If a number is in use on more than one telephone, then calls made to any of the other telephones will be forwarded as well.

Divert MSN (MSN call forwarding): Use the "Divert MSN" (MSN = Multiple Subscriber Number) to forward incoming **external** calls per MSN to **external destinations**. Several MSNs can be grouped together (this is configured by the system administrator) and forwarded to a common destination number.

A list of the configured MSNs and MSN groups is displayed. Select an entry. Select the desired forwarding type: **Immediately**, **Busy**, or **After delay**. Then enter the external destination and activate call forwarding. Active call forwarding is indicated by a "+" sign. This is followed by the call forwarding destination. A "?" preceding the entry, (e.g. ? **MSN Group 1**), means that call forwarding is active for only some MSNs or that there are different call forwarding types activated for this group.

Note: For the "Divert MSN" type of call forwarding, the (external) destination number is always entered without the area code. If "Divert MSN" is executed in the exchange (= external call forwarding; configured by the system administrator), it can take a few seconds after configuration for call forwarding to be activated in the exchange.

Divert door (door call forwarding): This is where you can programme "Divert call immediately" for door calls. If several doorbells are configured on the communications system, first select the doorbell whose calls are to be diverted. The number of doorbells available and with which names they are listed in the menu, depends on the type of entrance intercom. Consult your system administrator if you have questions concerning the configuration of the doorbells.

Then enter the call forwarding **Dest** (destination) (for information on entering the call number please refer to the chapter External Seizure and Entry of Call Numbers starting on page 52 also). Activate the call forwarding with the **On** option. Active call forwarding is indicated by a “+” sign. This is followed by the call forwarding destination.

Remote divert (call diversion for): You can also configure call forwarding for other OpenCom 100 / Aastra 800 users. Programming call forwarding for a virtual call number is also possible (please refer to Call for a virtual call number (Tele Secretary) on page 60 also). In order to do so, “Call forwarding for other user” authorisation is required, otherwise this menu item will not be displayed. Also, you can configure call forwarding only for those users whose terminal has not been blocked for this type of access (these users themselves have authorisation to “Prevent call forwarding by other user”).



Enter the internal phone number you wish to forward. The next steps are identical with programming call forwarding (see page 85).

Follow me: This type of call forwarding diverts calls from another terminal (source) to your telephone. The PIN of the source terminal is required for this function. If the “follow me” function is active, all call numbers of the other device are forwarded **immediately** to your telephone (exception: calls for hunt group call numbers).

Enter the **Source**, the internal call number from which calls are to be forwarded. Enter the **PIN** (user PIN) of the source. Activate the call forwarding with the **On** option. You can switch “Follow me” call forwarding off again on your own telephone or on the other terminal via the **Off** option. You can also switch off “Divert call immediately” on the other terminal.

“Messages” Menu

Short messages: You can exchange short messages with other communications system users with a system terminal.

Received mail: A list of message senders is displayed. Use the  arrow keys to select a message, press the  softkey and then select one of the following options.

Show: The text of the short message is displayed. Use the  arrow keys to scroll through the text and view date and time the message was received at the end.

Delete: You delete the message.

Forward: You can edit the message and then forward it to another user. Press the **OK** softkey to forward it. Enter the internal call number of the user to whom you would like to forward the message. You can also select a call number from the phone book. Confirm input/selection of the call number with the **OK** softkey.

Delete all: You delete all short messages received.

Outgoing mail: A list of messages you have sent is displayed. In the same way as described in the previous section, you can forward or display these messages.

New message: You can send a message to another user. First enter the text (max. 160 characters) and then press the **OK** softkey. Enter the internal call number of the user to whom you would like to forward the message. You can also select a call number from the phone book. Confirm input/selection of the call number with the **OK** softkey.

Short messages can also be sent with the **OpenCTI 50 / Aastra CTI 800** Web application. Please refer to the OpenCom 100 / Aastra 800 communications system online help for information.

E-Mail: A list of senders of received e-mails is displayed. Use the **↔** arrow keys to select a message, press the **OK** softkey and then select one of the following options.

Show: The subject line of the e-mail is displayed. Use the **↔** arrow keys to scroll and view date and time the e-mail was received.

Delete: You delete the e-mail notification.

Delete all: You delete all e-mail notifications received.

Note: The actual e-mails are not deleted. You can access and edit these at your desktop PC with your e-mail programme.

Appointments: The status of the two messages is displayed. Use the **↔** arrow keys to select an appointment, to programme it and then press the **OK** softkey. Enter the time the appointment call is to be carried out under **Time**. Select **Reason** to enter the reason for the appointment. Select the type of repetition: **Single**, **Date** (enter the specific date in the dd.mm.yy format), **Mo - Fr**, **Sa - Su** or **Every day**. **On** activates the appointment call and **Off** deactivates it.

Presence: You can inform other communications system users regarding your presence status, e.g. you are currently not in the office or on holiday. The text

appears on the display of the caller of an internal call provided that the caller's telephone is a system terminal. There are pre-defined message texts available for this. Select the desired text. If no message is to be displayed, select the text **Available**. Furthermore, you can write your own message text (23 characters maximum length). Select the **Text:** menu entry, enter the text and press the **OK** softkey. The text is now saved and selected in the Presence list. You can overwrite this text anytime.

Note: The settings of the **Presence** menu entry are saved on the communications system and remain after a re-start as well.

Messages can also be entered and selected with the **OpenCTI 50 / Aastra CTI 800** Web application. Please refer to the OpenCom 100 / Aastra 800 communications system online help for information.

Received fax: This menu entry is displayed on the OpenCom X320 communications system if the system administrator has configured the fax function. You see the sender list of received faxes. Use the  arrow keys to select an entry, press the **OK** softkey and then select one of the following options.



Delete: The fax is deleted.

Info: Information on the fax is displayed: date/time received, sender and fax memory size.

Delete all: All received faxes are deleted after a confirmation query.

A fax is saved as an image file on the communications system. Use the **OpenCTI 50 / Aastra CTI 800** Web application to view and save the fax. Please refer to the OpenCom 100 / Aastra 800 communications system online help for information.

“Phone Settings” Menu

Key lock: You can protect your telephone keypad from unauthorised access. An active keypad lock is displayed with the  symbol in the softkey line. To unlock the keypad, press the softkey under this symbol and then the  key. Alternatively you can hold down the  key for ca. 2 seconds to activate the keypad lock when idle.

Alarm: You can enter a time ranging from 00:00 to 23:59 at which the telephone issues a signal. The alarm lasts ca. 1 minute and can be switched off by pressing any key. After each signalling of an alarm, you must activate any subsequent alarm once again.

Alarm active: This setting activates (🔔) or deactivates the alarm. The 🔔 symbol appears on the display indicated an alarm is activated.

Set: When the 24 hour time format is set, enter the alarm time between 00:00 and 23:59. The time can be selected between 00:00 and 11:59 for the 12 hour format. Enter "am" with key 2 (a on display), "pm" with key 7 (p on display). You can configure the signalling melody as described below. The alarm signalling lasts ca. 1 minute and can be switched off by pressing any number key. After each signalling of an alarm, you must activate any subsequent alarm once again.

Date/Time: If the date and/or time is transmitted by the system, this menu entry cannot be changed. If the system where the mobile unit is currently checked into does not transmit date and time you can enter the current date/time. For 12-hour format: After entering the time use the number 2 to switch to "am" or number 7 to "pm". You can set the date and time display format in the "Telephone Option" menu (see page 95).

Melody: Select one of 10 melodies for signalling the alarm. To do so, press one of the number keys or select the melody with the arrow keys. You can also change this melody under "Ringer settings> Melody" (see the following section).

Ringer Settings: This menu is for setting ringer volume and signalling for your telephone.

Melody: Different call types can be signalled using different melodies. There are 60 different melodies available respectively. Select the call type:

Internal = internal calls

External = external calls. If there are multiple trunk keys configured on your telephone, you can configure a separate melody for each of these keys. To do so, select the desired key (e.g. **L1: [internal call number]**) and then press the 📞 softkey.

Unknown Number = call from unknown call number

VIP = VIP calls

Emergency Call = emergency call received

Alarm = please refer to page 89 also

Messages = call when message received

Enter a number (1...9 or for two-digit entry, 10...60, pressing the numbers quickly one after another) or change the number displayed with the arrow keys.

Type: This setting determines how selected melodies are signalled.

Repeat: The melody is played (repeatedly) as long as the call is signalled.

Play once: The melody selected is played just once when there is a call.

Device: You can select the combination of signal generators with which the call will be signalled.

Buzzer: Activates or deactivates the acoustic ringer tone. If you deactivate the signal generator then this is shown in the display with the  symbol.

Vibrator: Activates or deactivates the vibration signal generator.

Note: If you switch off all signal generators, a call is only signalled optically on the display with the  symbol.

Headset: Signals the call on the headset if this is connected to the mobile unit.

Volume Settings: Select the buzzer volume signalling (1 ... 8) via entering a number or with the arrow keys.

Volume Settings: Select the volume at which you wish to hear the person calling you (via **Earpiece**, **Hands-free** and **Headset**). Enter a number (1 ... 8) or select the volume with the arrow keys. In addition, you can also set the volume for the **Buzzer** here.

System: This menu offers you settings for subscribing and checking in the mobile unit on a communications system. Please note the information in the chapter Subscribing Mobile Unit starting on page 22 also.

Note: The **System** menu entry is possibly displayed in the main menu directly. This is the case when the mobile unit is not yet checked in or if the mobile unit, for example, is simply checked into a GAP base station.

Subscriptions: Use this menu to subscribe the handset to one or more communications systems and administer the subscription records necessary for checking in. Please refer to the The "Subscriptions" Menu on page 23 section for further information.

IPEI: The international mobile unit code is displayed (IPEI = International Portable Equipment Identity).

Version Number: The software and hardware version number of the mobile unit are displayed. Depending on the software version, you can also view the internal memory usage and memory usage of an inserted MEM card.

Managing existing subscription

The following menu entries are available when there is at least one existing subscription entry.

Navigate to the **System > Subscriptions** menu entry. Select the desired subscription entry or select the menu entry **Auto.Search** (Automatic Search). Confirm with the **Options** softkey.

New: Begin a new subscription with this menu entry. For details, please refer to Creating New Subscription starting on page 25.

Select:

- when you select **Auto. Search:** If you have subscribed the mobile unit to multiple communications systems, the mobile unit (when idle) will automatically select and check itself in to one of the reachable and subscribed communications systems. Your mobile unit will thus be automatically checked in to another communications system as soon as you are out of range of the current communications system.
- when selecting an existing subscription entry: Selecting this menu entry selects a specific communications system. Even if there are also other existing subscription entries, only the manually selected entry is used for checking in.

Edit (only when selecting a subscription entry): You can change the name and call number display of the subscription selected (usually the internal/local call number of the mobile unit). This information is displayed in the idle state when the mobile unit is checked into a communications system and no priority status information is displayed.

Note: Entering an internal call number for the mobile unit is irrelevant on the OpenCom 100 / Aastra 800 as the internal call numbers are managed by the communications system.

GAP only (only when selecting a subscription entry): Activate or deactivate this mode with the **OK** softkey.

- Not activated (recommended): The mobile unit uses extended system telephony functions. Use this mode for operation on a communications system.
- Activated: The mobile unit acts like a standard GAP telephone. Use this mode when the GAP base station subscription is not successful.

Delete (only when selecting a subscription entry): This menu entry deletes the subscription entry on the mobile unit. The mobile unit can only be operated on this communications system again after re-subscription.

Telephone Option: This menu contains device settings for the mobile unit.

Language: Select one of the languages listed for the display.

User Name: Enter a name for your mobile unit. This appears when idle. Your system administrator may already have entered a name. For information on text entry refer to page 35.

Attention Tones: You can configure tones that the mobile unit uses to notify you of various “events”.

Key Click: Each key press is confirmed.

Coverage Warn (coverage warning): Notification tone every 10 sec. when you are at the edge of the RFP coverage area and there is a risk the connection will be interrupted.

Battery Alarm: Notification tone every 30 seconds when battery charge capacity gets too low. There are ca. 5 minutes remaining before the connection is disconnected.

Confirm Tones: Tone when procedure successfully completed.

End of Menu: Tone indicating end of a list/of a menu.

Emergency Call: The emergency call number is the call number dialled upon a long key press of the emergency call key (**☎** key). This menu entry is not offered when the emergency call number is administered by the system.

SOS number: Before entering the emergency call number, press the **☎** key. This ensures that the emergency call numbers can also be dialled during a call. You can enter any internal or external call

number. When you programme an external call number for the SOS destination you may have to – depending on the system configuration – prefix the call number with the code for external line seizure.

SOS beep: Configure whether an emergency call is also signalled with a loud beep on your mobile unit (so that the device/person that triggered the emergency call can be located).

Hands-free: You can configure whether your mobile unit switches to the handsfree mode during an emergency call. This means that the person receiving the emergency call can listen and speak throughout the room.

Melody: If your mobile unit is one receiving emergency calls, you can configure the melody signalling the emergency call. Select a melody via the arrow keys. You can also change this melody under “Ringer settings> Melody” (see page 90).

Loud Environm. (loud environment): It may be useful to activate this function in a loud environment. The mobile unit then tries to enhance voice transmission.

Auto Answer: If this function is activated the mobile unit automatically answers a call after the first ring (useful when using a headset). Note: If you are not using the headset, then please deactivate this function as a caller may listen in unnoticed otherwise.

Silent Charging: As long as the mobile unit is in the charging station no calls are signalled. This applies to both acoustical signalling as well as optical signalling or to the vibration signal generator.

Charger Answer (Automatic Answer): If this feature is activated, the mobile unit automatically answers a call when it is removed from the charging station (this means the ☹ receiver key does not have to be pressed). When the mobile unit is replaced into the charging station, the call is switched to the handsfree mode.

Auto.Quick Hook (Automatic speed dialling): If this feature is activated, a local phone book entry designated for speed dialling is dialled immediately (see page 80). Dialling additional single digits after dialling has taken place is not possible. If it is deactivated, the corresponding call number goes to pre-dialling first and digits can be added.

Auto.Key Lock (Automatic Key Lock): If this feature is activated, the key lock is automatically activated 60 seconds after the last key press when the device is idle.

Charging LED: After removing the mobile unit from the charging station the display illumination goes on. Switch this function off if you wish to save energy.

Disp.Contrast: Select the level of display contrast by entering a number (1 ... 8) or with the arrow keys.

Date/Time: You can select the time and date format customary in your country here. If the time is not transmitted by the communications system, you can set it in the "Phone Settings" menu (see page 90).

Date Format: Select the date format dd.mm.yy (e.g. 31.12.08) or mm/dd/yy (e.g. 12/31/08).

Time Format: Select the 24 hour or 12 hour (am/pm) format.

Call time: If this feature is activated the call duration appears on the display during a call.

Display Time: You can switch display of the current time on/off.

Reset: Use the following menu entries to reset settings:

Handset: After a confirmation query, the mobile unit is reset to the factory settings. This means that all settings/entries are deleted, excepting system subscriptions and the PIN.

Telephone Option: This resets the settings in the "Telephone Option" menu only.

Telephone Book: Only your local phone book is deleted.

Note: When resetting the mobile unit and the telephone options any saved emergency call number is also deleted.

Security: This menu entry allows you to prevent unauthorised use of your telephone keypad. To do so, you require a PIN (Personal Identification Number). The default is "0000" (4 digits of 0 (zero)).

Lock Handset: Confirm with the  softkey, the mobile unit is now locked.

PIN Lock appears on the display. Outgoing calls are no longer possible. You may still accept incoming calls. The emergency call key ( key) programmed with a call number can still be used.

Change PIN: You can change your PIN (4-digit) here. Enter your current device PIN (default: "0000") and then the new PIN twice. You require the PIN for access to the "Security" menu entry described here where you can lock the telephone keypad.

"Protection" Menu

Call protect.: Switches call signalling for all call numbers of your device **On/Off** (exception: VIP calls are still signalled). You can activate call protection for internal calls only, for external only or for all calls. When call protection is activated, a caller hears either a ringing tone or a busy signal (the system administrator configures this when configuring user groups). If there are multiple trunk keys configured on your telephone, you can switch call protection on/off for each of these keys. To do so, select the desired key (e.g. **L1: [internal call number]**) and then press the **OK** softkey.

Note: Call protection is only in effect on the terminal where it was activated. If the internal call number of the terminal is available multiple times (i.e. on other terminals as well), call protection is not automatically activated on them.

Announc. prot. (announcement protection): Switching the announcement protection **On** or switching it **Off**. When announcement protection is activated, no announcements can be made to your telephone (please refer to page 70 also).

If there are multiple trunk keys configured on your telephone, you can switch announcement protection on/off for each of these keys. To do so, select the desired key (e.g. **L1: [internal call number]**) and then press the **OK** softkey.

Telephone lock: If you wish to temporarily allow another person to use your telephone, you can activate the telephone lock. Then your telephone is given the authorisations for the "Guests" user group. This user group is configured by the system administrator and facilitates locking various menu entries and list accesses on your device so that unauthorised persons cannot read or change them. Dialling rights may also be restricted. Please contact your system administrator for information on the altered range of functions when the telephone lock is on. Telephone lock access is user-PIN protected (default "0000"). After entering the PIN, activate / deactivate the function with the **On** or **Off** option.

Baby call: Enter the destination call number and activate or deactivate the baby call (please refer to the chapter Baby Call starting on page 69 also).

Change PIN: Enter the current user PIN (6-digits max.) and then the new PIN twice. You require this PIN for accessing the telephone lock (see page 96). If you have misplaced your PIN, please contact your system administrator.

Availability: All active features that hinder your availability are cleared (i.e. call protection, call-waiting protection, call forwarding).

Call wait. Prot: During a telephone conversation and are thus busy, authorised internal subscribers can signal call waiting to you to gain your attention. If you would like to prevent this, activate call waiting protection; the caller hears a busy signal. If there are multiple trunk keys configured on your telephone, you can switch call waiting protection on/off for each of these keys. To do so, select the desired key (e.g. **L1: [internal call number]**) and then press the **Ok** softkey.

Note: Call waiting protection is only in effect on the terminal where it was activated. If the internal call number of the terminal is available multiple times (i.e. on other terminals as well), call protection is not automatically activated on them.

Intercom prot. (Intercom protection): Activate (**On**) or deactivate (**Off**) intercom protection. When intercom protection is activated, no intercom announcements can be made to your telephone (please refer to page 70 also).

“Connections” Menu

The following features are executed if the current connection state of your telephone permits. These features are also available in the state-dependent menus.

Select one of the following menu entries in the **Connections** menu...

Select **Call pick-up** then...

Pick-up: You pick up the call intended for another telephone in your pick-up group.

If the called subscriber belongs to a user group with pick-up protection activated, you cannot pick up calls for that person’s call number.

Pick-up select: After entering the call number, you pick up the call for any other telephone.

If the called subscriber belongs to a user group with pick-up protection activated, you cannot pick up calls for that person’s call number.

Note: If the other telephone is already in the call state (e.g. an answering machine is making an announcement), you can pick up the call with “Pickup select.”. The subscriber for whom you picked up the call must belong to a user group for which “Call removal” authorisation is activated, otherwise “Pick-up select” is not possible.

Take: You wish to take a current call from one terminal over to your DECT telephone and continue the call on the DECT telephone. To do so, your DECT telephone and the other terminal must have the same internal call number.

Select **Dial** then...

Announcement: You direct an announcement to other **system terminals** (please refer to page 70). Enter the call number under **To:**. Announcements can also be directed to call numbers where multiple subscribers can be reached (e.g. a hunt group call number).

Note: If a called subscriber has announcement protection on (see page 96), this feature is not executed.

Intercom: This function is for directing an announcement **to a single system terminal** and the microphone is switched on on the system terminal called (please refer to page 70). The subscriber called can answer you immediately without having to press a key. Enter the device ID of the terminal in **Device-ID**. For information on the device IDs available, contact your system administrator.

Note: If a called subscriber has call waiting protection on (see page 97), this feature is not executed.

VIP call: Your next internal call is executed as a VIP call. Enter the call number under **To:**. Even when the internal subscriber called (with system terminal only) has activated call waiting protection, call protection or call forwarding, your call is now signalled acoustically.

Door opener: You activate the door opener.

Phone book: You open the OpenCom 100 / Aastra 800 phone book and can call one of the subscribers listed there (please refer to the chapter Calling from the Communications System Phone Book starting on page 75 also).

Switch auth. (Switch authorisation): You switch another terminal into a user group defined by the system administrator. When the user group is changed, this involves different authorisations, e.g. the authorisation for international dialling. This switch only applies to the next call conducted on this terminal. Please consult your system administrator regarding changed authorisations when switching user groups.

Number: Enter the internal call number of the terminal whose authorisation you wish to switch. Use **On/Off** to activate/deactivate the switch.

Phone book: You can find and select the desired call number in the communications system phone book (see page 75). Use **On/Off** to activate/deactivate the switch.

Note: If the terminal to be switched is making a call, the authorisation switch takes place when the call is finished. If the next call is not begun within 60 seconds, the authorisation switch expires automatically. At the end of the call, you receive – if configured this way – a brief message on your telephone regarding call duration and relevant charges incurred.

PIN dialling: For the next call, you switch your telephone into one of the user groups defined by the system administrator. Switching the user group means different authorisations (e.g. international dialling authorisation) and other features are possibly available (e.g. for charging and recording connection data of private calls). Please contact your system administrator for information on system configuration and the designated application area for PIN dialling. First you enter your internal call number under **Number** and then your user PIN under **PIN**. Then you can dial the desired call number.

Note: PIN dialling can be done from any terminal which belongs to a user group with this authorisation activated. The call numbers dialled using PIN dialling are not saved in any redial list, neither on the terminal used, nor on one's own terminal.

Lists: When there are multiple call numbers (trunk keys) configured for your telephone, you can define which number(s) are to be recorded in the caller lists (missed calls and accepted calls) and the redial list. Select the desired call number. Use **On/Off** to activate/deactivate the lists for this call number.

“Phone book” Menu

Notes on phone books





You can edit **communications system** phone books in this menu. You can add, edit and delete entries in your personal phone book. If your system administrator has authorised your user group accordingly, you can also edit the central phone book and your company’s phone book. An entry in the company phone book can be used by all employees in your company. For information on company phone books, please refer to the “Mounting and Commissioning” manual (for the Aastra 800: “Installing and Commissioning”) in the “Multi-Company Variant” chapter and in the online help of the OpenCom 100 / Aastra 800 communications system.

You can enter multiple call numbers per entry (per name) (office, mobile and personal) and designate one of these numbers as the **default number**. The default call number is dialled automatically if no other call number is selected before establishing a connection.



You can also assign a speed-dialling number (Abbrev. no.) to the call numbers of the entry in the central phone book. To do so, the system offers you the next respectively available speed-dialling number.

Select one of the following menu entries in the **Phone book** menu...

Creating New Phone Book Entry

-  and **OK** Select the **New entry** menu entry in the **Phone book** menu, confirm with the **OK** softkey.
-  and **OK** Select desired phone book: **Personal**, **Company** or **Central**, confirm with **OK** softkey.
-  and **OK** Enter **Name** and **First name** (see The Editor starting on page 35), confirm with **OK** softkey respectively.
-  and **OK** Enter call number **No. office**, confirm with **OK** softkey.





You can assign a speed-dialling number to the call numbers of the entry in the central phone book. You automatically have the next available speed-dialling number (**Abbrev. no.**) offered to you. If you wish to assign them, press the **OK** softkey. If not, delete the speed-dialling number with the  key (enter another unused speed-dialling number if needed) and then press **OK**.

-  and **OK** Display your own call number, confirm with **OK** softkey:
Transmit number: When calling (from the phone book) your call number is displayed to the subscriber called.
Suppress number: Your call number is suppressed.
-  and **OK** As necessary – just like in the two previous steps – enter additional call numbers (**No. mobile** and **No. Private**), confirm with **OK** softkey respectively.
-  and **OK** Dialling default number (**Default office, Default mobile** or **Default private**), confirm with **OK** softkey. The phone book entry is saved.
 The default call number is dialled automatically if no other call number is selected before establishing a connection.

Note

If you do not activate the “Suppress number” function for a call number saved in the telephone book, you can suppress the display of your call number from call – i.e. before you dial the destination call number.

Edit phone book entry

-  and **OK** Select the **Edit** menu entry in the **Phone book** menu, confirm with the **OK** softkey.
-  and **OK** Select desired phone book: **Personal, Company** or **Central**, confirm with **OK** softkey.
-  Enter letter/name you are searching for (see The Editor starting on page 35).
-  and **OK** Use arrow keys to select the entry desired, confirm with **OK** softkey.
-  Select **Delete** or **Edit** menu entry. To change the phone book entry, simply overwrite the existing information. The procedure is identical to the one described in the section Creating New Phone Book Entry starting on page 100.

“Applications” Menu

This menu is only shown if the system administrator has set up additional programme packages for your communications system and you have the user authorisation to use these programmes.

Voicebox: This menu is only offered to you if the **OpenVoice / Aastra Voice** additional programme is installed and your system administrator has configured a voicebox for you. Select...

Voicebox mess. (voicebox messages): You see the list of received voicebox messages and can listen to them and edit them (please refer to “Voicebox messages” starting on page 84).

Call voicebox: You call your voicebox. The next steps are voice-controlled.

For detailed information, please refer to the user guide for the additional programme **OpenVoice / Aastra Voice**.

Server menu: Your communications system can also be extended via additional third-party programmes. It is possible to use individual functions of these programmes with your system telephone. The menu entry **Server menu** will be offered to you in this case. For further information, please consult the respective programme documentation.

“Central settings” Menu

In this menu you can define rules and settings for the time management of your system.

The **Time control** menu entry is available if the user group of your telephone has been granted “Time Control” authorisation by the system administrator. The **Date / Time** menu entry is available if the user group of your telephone has been granted “Configurator - Expert” authorisation by the system administrator. If you do not have any of these authorisations this menu will not be displayed on your telephone.

Select **Central settings**, then select...

Time control: On the OpenCom 100 / Aastra 800 communications system several time groups can be configured. Depending on the activated time group, incoming calls are signalled on different terminals. Switching back and forth between these time groups can be done manually or automatically – according to a schedule configured by the system administrator.

Select the **Automatic** entry to activate automatic time control. The configured time groups then switch automatically according to the schedule configured by the system administrator. This setting remains active until one of the existing time groups is set manually.

The system administrator can configure up to 10 time groups. The time groups are either numbered (default setting) or they have been given a name by the system administrator. You can manually select a specific time group; the automatic time control is then deactivated.

Note: Any “MSN” call diversion always remains in effect – regardless of the currently active time group.

Date / Time: The date and time are taken over from the exchange on the first external outgoing call. If this information is not transmitted by your network operator, you can set the date and time here yourself.

Information Menus

Use the ⓘ info key to access other menus with information on received, calls, messages, etc. as well as current settings of your telephone.

When the phone lock is activated (see page 96) access to the information menu is blocked.

“Info” Menu

This menu is for quickly locating received or saved messages. The same menu entries are also in the main menu. If there are new entries on the info list, the Info key flashes. The menu entries described as follows only appear when corresponding messages (calls, notifications) are there.

When idle, press the ⓘ Info key **briefly**. You see one or more entries...

Missed calls: Information on missed calls (please refer to the section “Call Lists” on page 82)

Voicebox mess.: Information on voicebox messages (please refer to the section “Voicebox Messages” on page 84)

Short messages: Information on short messages received (please refer to the section “Short Messages” on page 87)

E-mail: List of received e-mails (please refer to the section “E-mail” on page 88)

Appointment: Displays active appointment (please refer to the section “Appointments” on page 88)

Received Fax (only on OpenCom X320 communications system): Displays received faxes (please refer to the section “Received Faxes” on page 89)

Charges: Here you see the amount charged for the last call and the total charges for your telephone. If there are multiple trunk keys configured on your telephone, you can view the individual charges for each of these keys. To do so, select the desired key (e.g. **L1: [internal call number]**) and then press the **Ok** softkey.

Active features: Displays active features which restrict reachability (see next chapter on page page 104)

“Active features” Menu

This menu provides an overview of active features which impair your reachability. The same menu entries are also in the main menu. You can deactivate features here. The features are then removed from this menu.

When idle, press the **Info** key **longer** or select **Active features** in the “Info” menu (see page 103). You see one or more entries...

Call protect.: Call protection is activated; see the section “Call Protection” on page 96

Call diversion: Call diversion is activated; see the section “Call Diversion” on page 85

Hunt group: Your telephone is assigned at least one hunt group call number; please refer to the section “Hunt Group” on page 85

Time control: Time control is configured on the system and can be activated from the telephone; please refer to the section “Time Control” on page 102.

Installing USB Drivers

The Aastra 142d has a USB port for connecting to a PC. You have to install the USB driver for the Aastra 142d before you can use this connection. To do so you require:

- a PC with Microsoft Windows and USB interface,
- a USB data cable for your Aastra 142d (ID No. 4514346)
- and the installation programme for the USB driver. The installation programme is available for download on the Internet under <http://www.aastra.de> or <http://www.aastra.com>.

Note

The Aastra 142d may not yet be connected during driver installation.

1. Log in to Windows as the administrator.
2. Start the installation programme for the USB driver via "Setup.exe". Follow the steps of the installation assistant.
3. Then connect the Aastra 142d using the USB data cable. Use an unused USB port on your PC.

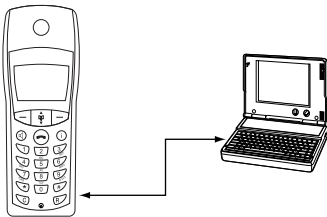

Connecting USB data cable

4. Check the USB connection. Start the Applet **System** in the Windows Control Panel. Select the **Hardware** tab in the **System Properties** dialogue. Click on the **Device Manager** button. The entries highlighted blue in the following screenshot must be shown.

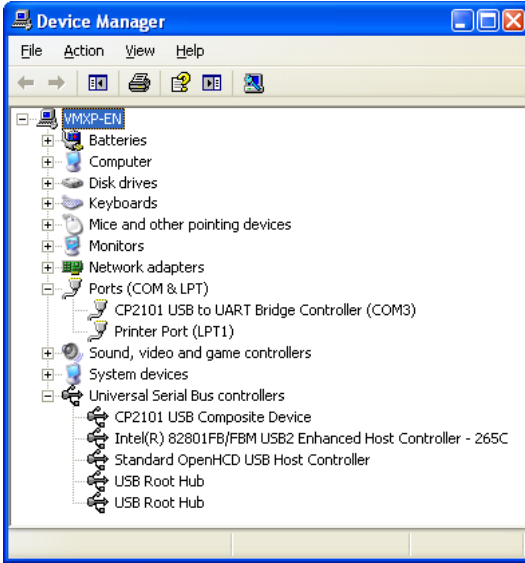



Windows Device Manager: USB driver components

Updating Software

The software for your Aastra 142d can be updated using a USB data cable.

Carry out the following steps to update the software for your Aastra 142d:

1. Install the USB driver (see Installing USB Drivers starting on page 105) and connect the Aastra 142d to your PC.
2. Start the programme for updating the software of your Aastra 142d.
3. Follow the instructions of the PC programme to carry out the software update.
After the programme has determined the configuration, your telephone is switched off.
4. Switch the device on again while holding down the  arrow key and then pressing the  key. Now your telephone software is updated.

PC Tool for Managing the Phone Book

There is a "PC Tool" programme available for managing the local phone book of the Aastra 142d. This enables you to transfer phone book data saved on your Aastra 142d to your PC and vice versa.

This PC tool as well as detailed information on installation and operation are available on the Internet at <http://www.aastra.de> and / or <http://www.aastra.com> for downloading.

Appendix

Important Information on Battery Use

Switch off the mobile unit before removing the batteries as there may be a loss of data otherwise.

1. Use nickel metal hydride (NiMH) batteries only!

The listed mobile unit operation times (ready for operation / calling) and charge times (see Technical Data starting on page 113) only apply with a battery capacity of 800 mAh.

The scope of delivery of the mobile unit includes 3 re-chargeable AAA NiMH cells.

Note

Using other battery types or non-re-chargeable batteries / primary cells can be hazardous and may also result in functional impairment or damage to the device.

For understandable reasons, the manufacturer cannot accept any liability in such cases.

- 2.** Batteries get warm while charging; this is a normal and non-hazardous process.
- 3.** Do not use any third-party charging devices. This may damage the batteries.
- 4.** Observe the correct polarity when inserting the batteries! Please refer to: Inserting/Removing Batteries starting on page 17.
- 5.** Never submerge a battery under water nor throw a battery into a fire.
- 6.** Do not take batteries apart. This could result in leakage of corrosive electrolytes.
- 7.** After inserting new batteries the battery status display takes a few charge cycles to be ready to display accurate charge status information.
- 8.** New batteries only reach their full capacity after a few charge/discharge processes.
- 9.** You can replace your mobile unit back onto the charging station after each call. The charging process is controlled electronically so that batteries at whatever charge level are optimally and carefully charged. Avoid removing the batteries for

no particular reason from the mobile unit as this impairs the optimal charging process.

The capacity of the batteries used can be improved when after more lengthy usage periods the batteries are fully discharged and then fully recharged.

- 10.** Do not short circuit the batteries (dangerous). Especially avoid accidental short circuiting during storage and transport due to, e.g. key ring and keys, metal plates or similar items and make sure that batteries do not come into contact with substances containing fats, oil or grease.

This is why batteries are stored outside the mobile unit in insulated packaging only. Make sure contacts do not come into contact with greasy parts either.

- 11.** Recycling of all used batteries is legally stipulated; they cannot be disposed of in domestic refuse. Dispose of used batteries in accordance with local government requirements. Be sure to recycle them. Batteries are recycled because they may contain, e.g. nickel cadmium (Ni-Cd), lead (Pb), cadmium (Cd) or mercury (Hg).

Care and Maintenance

Your telephone is a product that meets the highest standards of design and manufacture. It should therefore be treated with care. Follow the advice below, and you will be able to enjoy using this product for a long time.

Please follow all the Safety Precautions in the chapter Safety Information starting on page 8. These precautions apply to the mobile unit, the charging station, the batteries (the entire telephone), as well as the accessories.

Note

To clean the telephone, first remove the charger adapter plug from the mains socket. Wipe the equipment with an anti-static cloth or a soft, damp leather cloth. Never spray your telephone with cleaning fluid or solvents.

Clean the contacts of the mobile unit and charging station with a lint-free cloth. If your telephone or one of the accessories fails to function correctly, contact your supplier's customer service.

Environmental Properties and Disposal

(valid for the European Union)

The product was manufactured in line with the legal specifications and 2002 manufacturing directive and is recycling and environmentally compatible. It was developed with low energy usage, long service life span and user-friendliness in mind, using a limited amount of environmentally compatible materials and components. Help to extend the lifetime of your devices by following the safety precautions, information on battery lifetime and the care and maintenance precautions.

Notes on Disposal

In order to avoid any possible consequences resulting from the disposal of electrical and electronic equipment containing substances damaging to the environment and human health, the European Parliament and Council directives

- Directive 2002/96/EC on “waste electrical and electronic equipment” (WEEE) and
- Directive 2002/95/EC on the “restriction of the use of certain hazardous substances in electrical and electronic equipment” (RoHS)

have been transferred into national law in all EU member states.

The primary aim of the legislation is the prevention of waste electrical and electronic equipment, and also the recycling, material recovery and any other form of recovery of such waste in order to reduce the quantities of waste to be disposed of and the amount of hazardous substances from electrical and electronic equipment becoming waste.

The product that you have purchased was developed in line with current, state of the art technology in an environmentally friendly manner and with a view to recycling, thus complying with requirements of European directives.



The product is labelled with the symbol shown. If you wish to dispose of this product, this symbol obliges you to do so separately from unsorted domestic waste. For this reason suitable facilities have been set up for the return of waste electrical and electronic equipment. Waste equipment can be handed in at these return centres free of charge. To find out where these return centres are located, please consult the information provided by the department of your local authority responsible for waste disposal.

Attention!

Electrical equipment does not belong in domestic waste.
Deposit it free of charge at a return centre.

Declaration of Conformity

(valid for the European Union)

CE mark

This device complies with the requirements set down in the EU directive:
EU directive 1999/5/EC on radio equipment and telecommunications terminal equipment and the mutual recognition of their conformity. The conformity with the above-mentioned directive is confirmed by the CE mark on the device.

Limited Warranty

(valid for sale in USA, Canada)

Astra warrants this product against defects and malfunctions during a one (1) year period from the date of original purchase. If there is a defect or malfunction, Astra shall, at its option, and as the exclusive remedy, either repair or replace the telephone set at no charge, if returned within the warranty period. If replacement parts are used in making repairs, these parts may be refurbished, or may contain refurbished materials. If it is necessary to replace the telephone set, it may be replaced with a refurbished telephone of the same design and colour.

If it should become necessary to repair or replace a defective or malfunctioning telephone set under this warranty, the provisions of this warranty shall apply to the repaired or replaced telephone set until the expiration of ninety (90) days from the date of pick up, or the date of shipment to you, of the repaired or replacement set, or until the end of the original warranty period, whichever is later. Proof of the original purchase date is to be provided with all telephone sets returned for warranty repairs.

Exclusions

Astra does not warrant its telephone sets to be compatible with the equipment of any particular telephone company. This warranty does not extend to damage to products resulting from improper installation or operation, alteration, accident, neglect, abuse, misuse, fire or natural causes such as storms or floods, after the telephone is in your possession.

Aastra shall not be liable for any incidental or consequential damages, including, but not limited to, loss, damage or expense directly or indirectly arising from the customer's use of or inability to use this telephone, either separately or in combination with other equipment. This paragraph, however, shall not apply to consequential damages for injury to the person in the case of telephones used or bought for use primarily for personal, family or household purposes.

This warranty sets forth the entire liability and obligations of Aastra with respect to breach of warranty, and the warranties set forth or limited herein are the sole warranties and are in lieu of all other warranties, expressed or implied, including warranties or fitness for particular purpose and merchantability.

Warranty Repair Services

Should the set fail during the warranty period;
In North America, please call 1-800-574-1611 for further information.

Outside North America, contact your sales representative for return instructions. You will be responsible for shipping charges, if any. When you return this telephone for warranty service, you must present proof of purchase.

After Warranty Service

Aastra offers ongoing repair and support for this product. This service provides repair or replacement of your Aastra product, at Aastra's option, for a fixed charge. You are responsible for all shipping charges. For further information and shipping instructions;

In North America, contact our service information number: 1-800-574-1611.

Outside North America, contact your sales representative.

Note: Repairs to this product may be made only by the manufacturer and its authorized agents, or by others who are legally authorized. This restriction applies during and after the warranty period.

Unauthorized repair will void the warranty.

Technical Data

valid for ...	USA, Canada	All other countries
Standards:	DECT, GAP	DECT, GAP
Number of channels:	60 duplex channels	120 duplex channels
Frequencies:	1920 MHz to 1930 MHz (UPCS)	1880 MHz to 1900 MHz
Duplexing:	Time-division multiplex, 10 ms frame length	Time-division multiplex, 10 ms frame length
Channel spacing:	1728 kHz	1728 kHz
Bit rate:	1152 kbps	1152 kBit/s
Modulation:	GFSK	GFSK
Speech coding:	G.726 (ADPCM) with 32 kbps	G.726 (ADPCM) with 32 kbps
Transmission power:	5 mW (average output per active channel)	10 mW (average output per active channel)
Range:	up to 985 ft outdoors, 165 ft indoors	up to 300 m outdoors, in buildings up to 50 m
Charger power supply:	AC 100 V - 240 V / 50 - 60 Hz	AC 100 to 240 V / 50 - 60 Hz
Display:	5-line graphic display	5-line graphic display
Mobile unit weight:	3.67 oz without batteries, 4.90 oz with batteries	104 g without batteries, 139 g with batteries
Mobile unit dimensions:	5.75 x 2.09 x 1.10 in (Length / Width / Height)	146 x 53 x 28 mm (Length / Width / Height)
Charging station weight:	1.73 oz	49 g
Charging station dimensions:	4.76 x 2.09 x 1.10 in (Length / Width / Height)	121 x 107 x 70 mm (Length / Width / Height)
Length of power supply cable:	10 ft	3 m

valid for ...	USA, Canada	All other countries
Battery:	3 x AAA batteries (NiMh / 1.2 V / 800 mAh)	3 x AAA batteries (NiMh / 1.2 V / 800 mAh)
Stand-by Time:	up to 125 hours	up to 140 hours
Talk time:	up to 18 hours	up to 15 hours
Charge Time:	up to 6 hours	5 to 6 hours
Permissible ambient temperatures for mobile unit operation:	41° F to 104° F	5° C to 40° C
Permissible ambient temperatures for charger operation:	41° F to 104° F 20% to 70% relative humidity	5° C to 40° C 20% to 70% relative humidity
Permissible storage temperature:	14° F to 140° F	-10° C to +60° C

Menu Tree

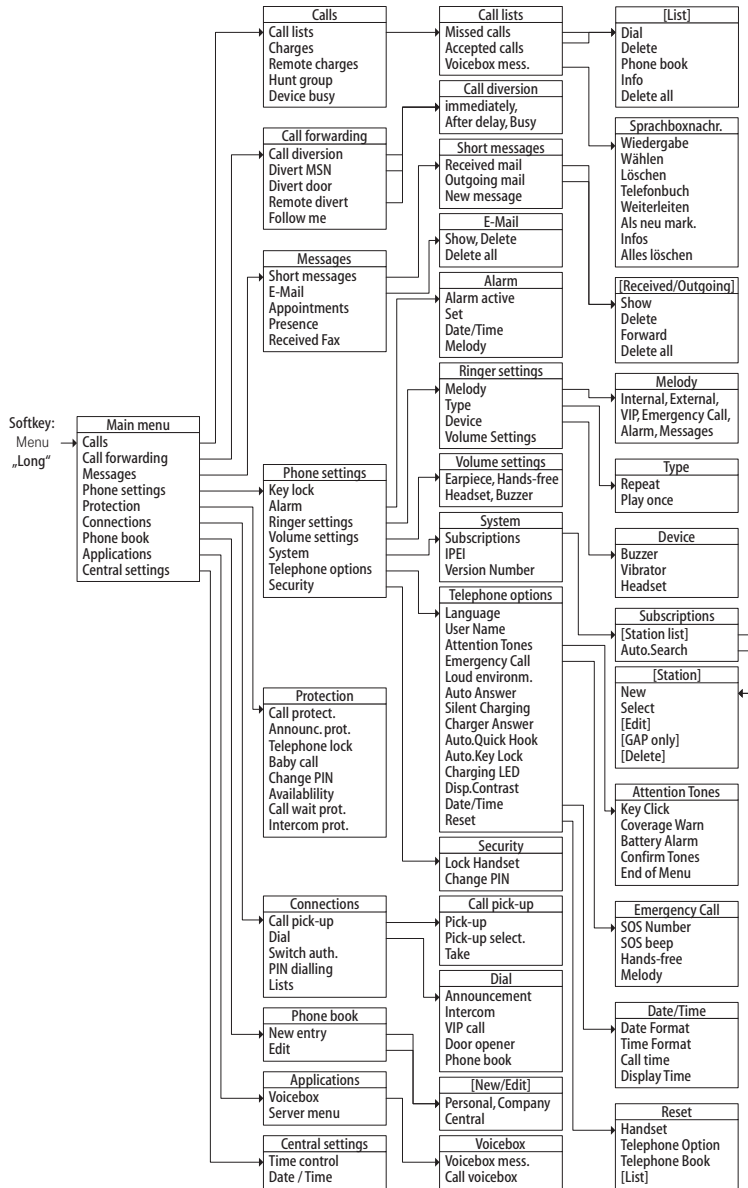

Index

A

- Active features (menu) 104
- Alarm 42, 69, 89
- Announcement 50, 70, 98
- Announcement protection 96
- Appointment call 68
- Appointments 88
- Arrow keys 31
- Attention tones 93
- Authentication code 25
- Auto answer 94
- Automatic call answering 94
- Automatic key lock 95
- Automatic quick hook 94
- Availability 97

B

- Baby call 69, 96
- Base station
 - automatic search 92
 - select 92
- Batteries 8
 - charging and usage times 17
 - charging, discharging 16
 - commissioning 16
 - empty (set notification tone) 93
 - inserting, removing 17
 - safety information 108
- Belt clip 27
- Blocked/Unblocked Call Numbers 45
- Booking number 47, 57, 65, 67
- Buzzer 91

C

- C key 33
- Call
 - accept 62
 - deflect 61, 62
 - end 59
 - park 57, 61, 69
 - reject 61
 - transfer to external subscriber 64
 - transfer to internal subscriber 63
 - unpark 50
- Call display 59
- Call diversion 65
- Call forwarding
 - divert MSN 52
 - door 86
 - entering call number for external line
 - seizure (manual/spontaneous) 52
 - follow me 87
 - for other users 87
 - for your own telephone 85
 - menu 85
 - MSN 86
 - to voicebox 48
- Call list
 - accepted calls 84
 - missed calls 82
 - voicebox messages 84
- Call lists 82
- Call number
 - suppress 50
 - transmit 50
- Call numbers
 - blocked/unblocked 45
 - internal, external 43
- Call protection 96

- Callback 58, 68
 - Caller list
 - calling from 55
 - Calling 53
 - from caller lists 55
 - from the Aastra 142d phone book 79
 - from the system phone book 75
 - Calling the entrance intercom 73
 - Calls
 - call-waiting call (state-dependent menu) 61
 - incoming (state-dependent menu) 61
 - menu 82
 - outgoing (state-dependent menu) 58
 - pick-up 97
 - Call-waiting protection 97
 - Call-waiting queue 46
 - Care and maintenance 109
 - Central settings (menu) 102
 - Change device PIN 96
 - Change user PIN 97
 - Charge display 19, 44
 - Charge time 17
 - Charges 50, 85
 - for... 85
 - Charging LED 95
 - Charging station 15
 - CLIP 44
 - CLIP no screening 44, 60
 - CLIR 45
 - CNIP 44
 - Code number procedure 81
 - Company phone books 75
 - Conference 62, 65
 - disconnecting subscribers 66
 - end 66, 67
 - initiate 66
 - state-dependent menu 67
 - Confirmation tones 93
 - Connections
 - lists 99
 - PIN dialling 99
 - switch authorisation 99
 - Connections (menu) 97
 - Conversation (state-dependent menu) 56
 - Coverage warning 93
- D**
- Date
 - set 90, 103
 - Date format 95
 - Declaration of conformity 111
 - DECT 12
 - Delete key 33
 - Device busy 85
 - Dial 98
 - Disconnect 61, 64
 - call 57, 58
 - conference participant 67
 - Display
 - contrast 95
 - display 29
 - language 93
 - lines 29
 - symbols 29
 - Door call forwarding 73
 - Door opener 50, 57, 58, 61, 62, 65, 67, 72, 98
 - Doorbell 72, 73
 - DTMF 43
- E**
- E-mail 33, 88
 - Emergency call 42, 93
 - Emergency call key 34
 - Enquiry 62
 - Entrance intercom 73

Entrance intercom calls 73

External seizure 52

F

Features 45

Follow me 87

G

GAP 12

H

Handsfree 40, 57, 61, 64, 67

Hash key 34

Headset 13, 91

Hearing aids 9

Hunt group 85

I

Illumination 31

Info

- active features 104

- appointments 104

- call diversion 104

- call protection 104

- charges 104

- e-mail 103

- hunt group 104

- menu 103

- missed calls 103

- short messages 103

- time control 104

- voicebox messages 103

Info key 32

Intercept 57

Intercom 50, 70, 98

Intercom protection 97

IPEI 25, 92

K

Key click 93

Key lock 40, 89

Keypad dialling 45

Keypad protocol 45

Keys 31

L

Least Cost Routing (LCR) 45

- switch off 50

Lock 95

Loud environment 94

Loudspeaker key 32

M

Main menu 51, 81

Making a call 53

Melody

- alarm 90

- call type 90

MEM card 20

Menu

- active features 104

- applications 102

- before and during a call 49

- call forwarding 85

- calls 82

- central settings 102

- connections 97

- hide automatically 38

- info 103

- main menu 81

- messages 87

- phone book 75, 100

- phone settings 89

- protection 96

Menu (state-dependent)

- busy subscriber 58

- conference 67

- during the call 58

- for call-waiting call 61
- for incoming call 61
- in conversation 56
- subscriber on hold 64
- when idle 49

Menübaum 115

Messages (menu) 87

Mobile unit

- lock 95
- subscribe 23

Muting 42

N

Notes 50

Number keys 34

O

Operational controls 28

Optical call display 59

P

PARK 25

Park 57, 61, 65, 67, 69

Personal phone book 75

Pharmacy line 73

Phone book 57, 61, 65, 67, 98

- add entry 78
- edit entry 101
- general information 75
- local 79
- menu 75, 100
- new entry 77, 100
- of the communications system 75

Phone settings (menu) 89

Pick-up 50, 97

- select 50, 97

Pickup 57

- select 57, 58

PIN

- change 96, 97
- telephone lock 96

PIN dialling 99

Portable part 25

Postdial (DTMF) 43

Power failure 8

Power supply 8

Pre-dialling 53

Presence 88

Protection (menu) 96

Q

Queue 46

R

R key 34

Radio connection

- dead spots 12
- quality 29

Radio fixed part 25

Recall 63

Received fax 89

Receiver key 32

Redial 53

Reset (settings) 95

Ringer

- device 91
- for incoming calls 90
- setting 90
- switch off 41, 59
- type 91

S

Safety information 8

Seize line 52

Server menu 102

Setting language (display) 93

Short messages 33

Signal key 34

- Silent charging 94
- Softkey
 - arrow keys 31
 - Esc 32
 - menu 32
 - OK 32
 - redial 32
- Softkey line 30
- Softkeys 31
- SOS number 42
- Speaker 40
- Speed-dialling 77, 80
- Star key 34
- Subscriber busy (state-dependent menu) 58
- Subscriber on hold (state-dependent menu) 64
- Subscription 23, 91
- Switch authorisation 99
- Switching device on/off 39
- Symbols (on the display) 29
- System (subscription to) 91
- T**
- Take 50, 57, 98
- Technical data 113
- Tele secretary 60
- Telephone lock 40, 96
- Telephone option 93
- Text lines 30
- Three-party conference 43
- Time
 - display when idle 42
 - set 90, 103
- Time control 102
- Time format 95
- Toggle 43, 62, 65, 67
- Transfer 62, 65, 67
 - to external subscriber 64
 - to internal subscriber 63
- Transmission of call numbers 44
- Trunk keys 43
- U**
- Un park 50
- Updating software 106
- Usage time 17
- USB port 105
- User 93
- V**
- Version number 92
- VF signalling 43, 45
- Vibration signal generator 91
- VIP call 60, 98
 - initiate 51, 58
- Virtual call number 60
- Voicebox 102
 - displaying messages 33
 - messages 30
 - query 74
- Voice-mail system 48
- Volume
 - adjust during call 41
 - for call 91
 - for incoming call 41
 - for ringer signalling 91



Copyright 2011 www.aastra.com
All rights reserved
As of 29.09.2011
Subject to changes

CE

AASTRA