

# Dialog 4220 Lite/Dialog 4222 Office

System Telephones for MD110 Communication System

User Guide



EN/LZT 103 60 R2A

© Ericsson Enterprise AB 2004

# Table of Contents

Welcome .....	4
Description .....	6
Free Seating (optional) .....	15
Incoming Calls .....	16
Outgoing Calls .....	19
During Calls .....	33
Call Forwarding .....	39
Absence Information (optional) .....	51
Messages .....	53
Group Features .....	59
Other Useful Features .....	62
Settings .....	69
Accessories .....	82
Installation .....	88
Troubleshooting .....	97
Glossary .....	98
Index .....	99

# Welcome

Welcome to the user guide for the *Dialog 4220 Lite* and *Dialog 4222 Office* system telephones in the Ericsson MD110 Communication System. It is a state-of-the-art business communications system. Its alliance of features and facilities effectively improves communications for virtually any kind of organization.

There is a line of telephones designed for easy use in every situation to take full advantage of these advanced features and facilities.

Function descriptions that do not include speaking in the handset, are described off-hook, if nothing else is stated. Instead of pressing the Clear key, you can always replace the handset.

Some markets use differing codes for some functions. In this guide, all functions are described using the most common code. The markets and their differing code is shown as a side note.

The user guide describes the facilities of the *Dialog 4220 Lite* and *Dialog 4222 Office* system telephones as they are programmed at delivery from the factory. There may be some differences in the way your phone is programmed. Please consult your system administrator if you need further information.

The latest version of this user guide can also be downloaded from: <http://www.ericsson.com/enterprise/library/manuals.shtml>

If you would like to practise the handling of the phone, you can try the “Ericsson Enterprise End User Training On Telephones”, available at:

<http://ericsson.tripnet.se/learn/gatestore/courses/EndUser/Usertool/index.htm>.

To start practising, select the option “Ericsson Enterprise eLearning”, and then select your type of phone.

**Note** *Dialog 4220 Lite and Dialog 4222 Office are system telephones, i.e. they can only be used for an Ericsson private branch exchange that supports these types of phones.*

## Copyright

All rights reserved. No parts of this publication may be reproduced, stored in retrieval systems, or transmitted in any form or by any means, electronic, mechanical, photocopying, recording or otherwise, without prior written permission of the publisher except in accordance with the following terms.

When this publication is made available on Ericsson media, Ericsson gives its consent to downloading and printing copies of the content provided in this file only for private use and not for redistribution. No parts of this publication may be subject to alteration, modification or commercial use. Ericsson will not be liable for any damages arising from use of an illegal modified or altered publication.

---

## Warranty

ERICSSON MAKES NO WARRANTY OF ANY KIND WITH REGARD TO THIS MATERIAL, INCLUDING, BUT NOT LIMITED TO, THE IMPLIED WARRANTIES OF MERCHANTABILITY AND FITNESS FOR A PARTICULAR PURPOSE. Ericsson shall not be liable for errors contained herein nor for incidental or consequential damages in connection with the furnishing, performance or use of this material.

---

## Declaration of conformity

*Hereby, Ericsson Enterprise AB, declares that this telephone, is in conformity with the essential requirements and other relevant provisions of the European R&TTE directive 1999/5/EC.*

Details to be found at: <http://www.ericsson.com/sdoc>.



# Description

## Dialog 4220 Lite/4222 Office phones

Dialog 4220 Lite

Dialog 4222 Office

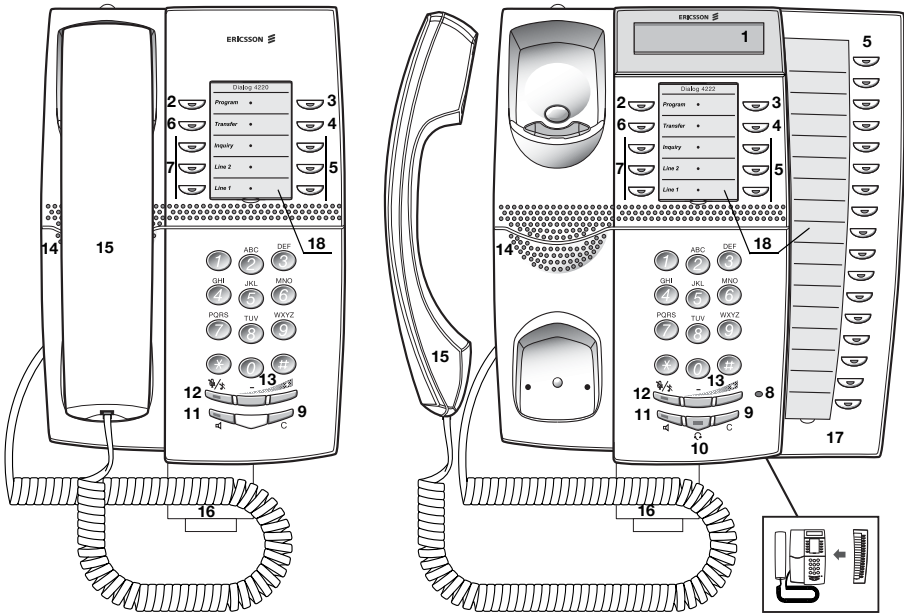

**Note:** The functions available on each model vary. If any functions differ or are unavailable, this will be indicated in the relevant section of the user guide.

- 1 Display (Dialog 4222 Office only)**  
2x20 characters. See section “[Display information](#)” on page 12.
- 2 Programming**  
See section “[Settings](#)” on page 69.
- 3 Callback**  
For indicating/activating Callback. See section “[When you receive a busy tone](#)” on page 23. The feature can be removed or moved to another programmable function key by your system administrator.

- 4 Diversion (Follow-me)**

For indicating/activating and deactivating Diversion (Follow-me). See section “[Call Forwarding](#)” on page 39. The feature can be removed or moved to another programmable function key by your system administrator.
- 5 Programmable function keys**

To program numbers or functions, see section “[Programming of function keys](#)” on page 69.
- 6 Transfer**

For transferring calls, see section “[During Calls](#)” on page 33.
- 7 Triple Access Line**

For handling calls. Line 1 and 2 are available both for incoming and outgoing calls. Inquiry can only be used for outgoing calls.
- 8 Microphone (Dialog 4222 Office only)**

Used for handsfree conversation.
- 9 Clear**

To disconnect calls or exit a function. Can always be pressed instead of replacing the handset.
- 10 Headset key**

To handle headset calls and activate Headset Preset. See section “[Headset \(optional\)](#)” on page 83.
- 11 Loudspeaker on/off**
  - a. To activate Group listening. See section “[During Calls](#)” on page 33.
  - b. To activate handsfree conversation (Dialog 4222 Office only). See section “[During Calls](#)” on page 33.
  - c. To activate Loudspeaker Preset (Dialog 4222 Office only). See section “[Headset Preset](#)” on page 84.
- 12 Mute**
  - a. To switch the microphone on or off during a call. See section “[Mute](#)” on page 34.
  - b. To switch off the ring signal in idle mode or when ringing. See sections “[Mute ring signal](#)” on page 76 and “[Silent ringing](#)” on page 76.
- 13 Volume control**

To change the volume. See section “[Settings](#)” on page 69.
- 14 Loudspeaker**

**15 Handset**

Supplied with hearing aid function as standard. An extra handset can be connected, see section “[Accessories](#)” on page 82.

**Please note:** *The handset may attract and retain small metal objects in the earcap region.*

**16 Pull-out leaf for easy guide (optional)**

See section “[Pull-out leaf \(optional\)](#)” on page 86.

**17 Key panel (optional, Dialog 4222 Office only)**

With 17 programmable keys. One panel can be connected. See section “[Key panel \(optional\)](#)” on page 82. Use the Designation Card Manager to make and print your own key panel designation cards, see below.

**18 Designation card**

Use the DCM (Designation Card Manager) to make and print your own designation cards. DCM is included on the Telephone Toolbox CD for MD110 Communication System or it can be downloaded from: <http://www.ericsson.com/enterprise/library/manuals.shtml>

For more information, please contact your Ericsson Enterprise certified sales partner.



## Lamp indications



Extinguished lamp

The function is not active.



Steady light

The function is active or multiple represented line is busy.



Slowly flashing lamp

The line (or function) is put on hold.



Rapidly flashing lamp

An incoming call.



Light with short breaks









Ongoing call.

## Tones and signals

The following different tones and signals are sent from the exchange to your phone.

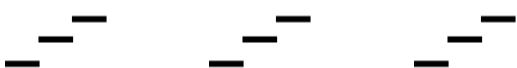
### Tone characteristics

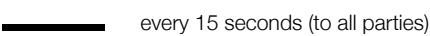
The tones shown in this section are the most used tones worldwide. Many markets use a differing tone for one or more situations.

Dial tone	
Special dial tone	
Ringing tone or queue tone	
Busy tone	
Congestion tone	
Number unobtainable tone	
Call waiting tone	
Intrusion tone	
Conference tone	
Verification tone	
Warning tone, expensive route	

### **Ring signals**

Three different ring signals inform you about the type of the incoming call. The signals shown in this section are the most used signals worldwide. Many markets use signals that are adapted for the local standards. If you get a signal that is not described or you cannot identify, ask your system administrator.

Internal ring signal



External ring signal



Recall signal  
(Callback reminder)



## Display information

**Notes:**

*The display is only available on the 4222 Office phone.*

*There are two versions of display texts, an earlier and a later version. Both versions are shown in this section.*

*The order in which the date is stated is system dependent.*

The display gives you feedback information such as time and date, traffic state and connected phone numbers. The following displays show examples of the different states your phone is in.

For the later display text version:

When an information ends with three dots (...), this means that the system is working or waiting for your action. When an information ends with an exclamation mark (!), this means that no further action is possible.

### **Idle phone (idle mode)**

When your phone is idle, the upper row shows general information. The lower row shows your extension number. In the example below, the extension number is **2222**.

Earlier version:

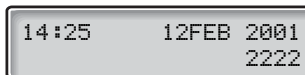

Later version:

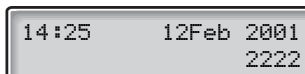

### Outgoing call

When you make an outgoing call on your phone, the upper row shows the traffic state and the lower row shows the dialed number.

Earlier version:



```
CALLING
                2222
```

Later version:



```
Callina...
                2222
```

If the called party's phone is diverted, the upper row shows the dialed number and Diversion information. For the later version, > is the Diversion symbol.

Earlier version:

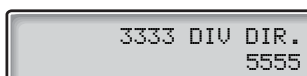

```
3333 DIV DIR.
                5555
```

Later version:

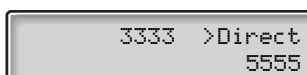

```
3333 >Direct
                5555
```

The dialed number (3333) is directly diverted to number 5555.

**Incoming call**

When you receive an incoming call, the upper row flashes the calling party's extension number.



If a diverting extension is calling, the upper row shows the Diversion information. The calling party's number is flashing on the lower row. For the later version, > is the Diversion symbol.

Earlier version:

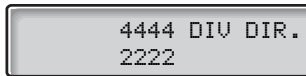

Later version:

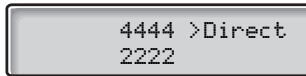

Number 2222 has dialed number 4444 and the call is directly diverted to you.

**Choice of language (optional)**

One of the following languages can be chosen to be used for the display information on your phone.

Digit 0-9 = the language code:

0 English    1 French    2 German    3 Spanish    4 Italian  
5 \_\_\_\_\_ 6 \_\_\_\_\_ 7 \_\_\_\_\_ 8 \_\_\_\_\_ 9 \_\_\_\_\_

**Note:** *By default 5-9 are programmed for English. To be changed locally to other languages.*

To choose a language:

**\* 0 8 \***

**( 0 - 9 )**

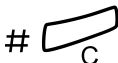

**Dial.**

**Enter the language code.**

**Press.**

## Free Seating (optional)

The Free Seating function is used for persons who have an office extension number but no phone set of their own. For example, flexible office workers, persons mostly working outside the office, etc. As a Free Seating user and working from the office, you logon to any free phone set that temporarily will be assigned with your extension number and your system authorities.

### To log on

**\* 1 1 \***

**Dial.**



**Enter the authorization code and press.**



**Enter your phone number and press.**



**Press to finish the procedure.**

The display shows your phone number.

### To log off

**# 1 1 #**

**Dial.**



**Press to finish the procedure.**

# Incoming Calls

## Answer calls

A ring signal and a flashing lamp indicate an incoming call.

### On Line 1

Normally you will receive calls on Line 1.



**Lift the handset.**

### On any other Line key

**Lift the handset.**



**Press the flashing Line key.**

### Handsfree

*(Dialog 4222 Office phone only).*



**Press the flashing Line key.**

You are connected to the caller via the loudspeaker and the microphone.



**Press to terminate a handsfree call.**



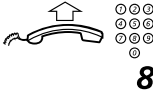

### On another extension

You can answer a call to a phone in another room:

**Call the ringing extension.**

**Press.**

**Notes:**

*You can also press On hold/Pick-up (function key preprogrammed by you).*

*France, press **4**; Sweden, press **6***

## Answer a second call during an ongoing call

If your phone is preprogrammed with a Free on 2nd key, you can receive another call, if this function is activated.

Free on 2nd 

**Press to activate/deactivate.**

When Free on 2nd is active the lamp is lit.

**Note:** *Function key preprogrammed by your system administrator.*

You have an ongoing call on Line 1, when Line 2 flashes to indicate a new incoming call:



**Line 2**

**Press to answer.**

The first call is put on hold.



**Line 1**

**Press to switch back to the first call.**

The second call is put on hold. You are connected to the first caller.



**C**

**Press to terminate the connected call.**

### Call Waiting

If the calling party has activated Call Waiting, you can receive a second call even if Free on 2nd is not activated.



To answer the waiting call:

**Press to terminate the connected call.**

Your phone will ring to announce the waiting call.



**Press the flashing Line key to receive the new call.**

---

### Do not disturb, DND

When you activate DND, calls to your extension are not indicated. Outgoing calls can be made as usual.



**Press to activate or deactivate DND.**

*Note: Function key preprogrammed by your system administrator. You can also use the procedure below.*

**\*27#**

**Dial to activate,**  
Special dial tone.

**or**

**#27#**

**dial to deactivate.**



**Press to finish activation/deactivation.**

*Note: If your phone is programmed with "Multiple Directory Diversion and Do not disturb" (ask your system administrator), DND is ordered and cancelled simultaneously on all lines. This function is only available in newer versions of the exchange.*

# Outgoing Calls

## Make calls

How to make internal and external calls:



**Lift the handset and proceed depending on call type:**

### Internal calls



**Dial the extension number.**

### External calls

**0**

**Press the digit or digits to get an external line.**

Dial tone.

**Note:** *The particular digit or digits used in your office, e.g. 0 or 00.*



**Dial the external number.**

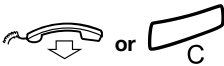

**Replace the handset or press to end the call.**

**Note:** *If you receive a queue tone when the digit or digits to get an external line are dialed (optional function Least Cost Routing is used in the system), keep waiting. Once a line becomes free you will receive a dial tone. If a warning tone is heard, the selected line is marked "Expensive".*



### **Handsfree**

*(Dialog 4222 Office phone only).*

#### **Dial the number.**

You are connected via the loudspeaker and the microphone.

#### **Press to terminate a handsfree call.**

**Note:** *You can make your calls faster by using common Speed Dialing numbers and by using your own programmed function keys. See section “Speed Dialing” on page 27.*

---

## **Number presentation restriction**

If you do not want your name and number to be displayed to the person you are calling, you can use the following procedure.

#### **Notes:**

*This function is only available in newer versions of the exchange, and it might be blocked for use on your extension (programmed by your system administrator).*

*The number presentation restriction is only valid for the ongoing call, i.e. the procedure has to be repeated the next time you want to use it.*

### **\* 4 2 #**



#### **Dial and wait for a new dial tone.**

#### **Dial the number.**

Instead of your name and number, the display on the called phone shows **Anonymous**.

## Individual external line

To make a call on a specific external line:

**\* 0 \***

**Dial.**

⊙ ⊙ ⊙  
⊙ ⊙ ⊙ #  
⊙ ⊙ ⊙  
⊙

**Dial the individual external line number and press.**

⊙ ⊙ ⊙  
⊙ ⊙ ⊙  
⊙ ⊙ ⊙  
⊙

**Dial the digit or digits to get an external line and the external number.**

## Last External Number Redial

When you initiate an external call the system automatically stores all the dialed digits, irrespective of whether the call was successful or not.



**Lift the handset.**

**\* \* \***

**Dial to repeat the stored number.**

The last external number is automatically redialed.

**Notes:**

*You can also press Last Number Redial (function key preprogrammed by you).*

*Finland and Sweden, dial \* \* 0*

## Save external number

When you make an external call, you can save the number in order to redial the same number easily. Any previously saved number is erased.

To save an external number:



**Press before you finish the call.**

**Note:** Function key preprogrammed by your system administrator.



### Redial number

**Lift the handset.**

**Press to redial the number.**

**Note:** Function key preprogrammed by your system administrator.

## When you receive a busy tone

If you call an extension and receive a busy tone, or get no answer, or all external lines are busy, you can use any of the following methods:

### Callback

If a called extension is busy or there is no answer:

**6**

#### **Press.**

It can take a couple of seconds before the procedure is executed.

#### **Notes:**

*You can also press: Callback (function key preprogrammed by you).*

*France, Finland and Sweden, press **5***



#### **Replace the handset to finish procedure.**

You are called back (recall ring signal) when the ongoing call is finished or the next time a new call is finished. You have to answer within eight seconds, otherwise the Callback service is cancelled. While waiting for the Callback, you can make and receive calls as usual.



#### **Lift the handset when you are called back.**

The system calls the extension.

**Note:** *Callbacks can be activated on several extensions at the same time. Callbacks from additional lines will recall on Line 1.*

If all external lines are busy (after dialing the digit or digits to get a line):

**6 Press.**

**Notes:**

*You can also press: Callback (function key preprogrammed by you).*

*France, Finland and Sweden, Press 5*



**Dial the external number and press.**

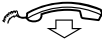

**Replace the handset to finish procedure.**

When an external line becomes free you will be called back (recall ring signal). You have to answer within eight seconds, otherwise the Callback service is cancelled. While waiting for the Callback, you can make and receive calls as usual.



**Lift the handset when you are called back.**

The system calls the external number.

**Note:** *Only one Callback can be activated on a busy external line. Callbacks from additional lines will recall on Line 1.*

**Cancel any single Callback**

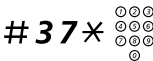

**Dial and enter the extension number.**

**Note:** *To cancel a single Callback on a specific external line, dial the digit or digits to get a line instead of the extension number.*



**Press.**

**Cancel all Callbacks**



**Dial.**



**Press.**



**Activate Call Waiting**

If you urgently wish to contact a busy extension or external line, you can notify by a Call Waiting signal.

**5 Press.****Notes:**

*You can also press: Call Waiting (function key preprogrammed by you).*

*France and Finland, Press 6; Sweden, Press 4*

Keep handset off hook. When the called extension or the external line becomes free, it will be called automatically.

**Note:** *The Call Waiting function might be blocked for use on your extension (programmed by your system administrator). If Call Waiting is not allowed you will continue to receive a busy tone.*

**Intrusion on a busy extension**

You can intrude on an ongoing call on a busy extension.

**4 Press.****Notes:**

*You can also press: Intrusion (function key preprogrammed by you).*

*France and Sweden, Press 8*

Before the Intrusion is executed a warning tone is sent to the parties in the ongoing call. A three party call is established and a warning tone is heard.

**Note:** *The warning tone might be disabled for your system. The Intrusion function might be blocked for use on your extension (programmed by your system administrator). If Intrusion is not allowed, you will continue to receive a busy tone.*

### Intrusion on a busy external line

You can intrude on an ongoing call on a busy external line.

**\* 4 4 \*** 

**Dial and enter the individual external line number.**

**#** 

**Press and dial the digit or digits to get an external line.**

Busy tone.

**4**

**Press.**

**Notes:**

*You can also press: Intrusion (function key preprogrammed by you).*

*France and Sweden, Press 8*

Before the Intrusion is executed a warning tone is sent to the parties in the ongoing call. A three party call is established and a warning tone is heard.

**Note:** *The warning tone might be disabled for your system. The Intrusion function might be blocked for use on your extension (programmed by your system administrator). If Intrusion is not allowed you will continue to receive a busy tone.*

---

## Bypass

If this function is allowed from your extension, you can bypass an; *activated Diversion, activated Follow-me or activated Absence information* on a specific extension.

**\* 6 0 \*** 

**Dial and enter the extension number.**

**#**

**Press and wait for answer.**

## Speed Dialing

### Common Speed Dialing numbers

By using common Speed Dialing numbers, you can make calls simply by pressing a few keys. The common Speed Dialing numbers consist of 1–5 digits and are stored in the exchange (by your system administrator).



**Lift the handset and dial the common Speed Dialing number.**

### Individual Speed Dialing numbers

You can program up to ten frequently used phone numbers on the digit keys 0–9 and use them as individual Speed Dialing numbers (if this function is allowed).

**Note:** In Finland, up to nine numbers, keys 1–9.

To use:

**\* \* ( 0 – 9 )**

**Dial and press the relevant digit.**

**Note:** Finland, dial \* \* ( 1 – 9 ); Sweden, dial ( 0 – 9 ) #.

To program and alter individual Speed Dialing numbers:

**\* 5 1 \* ( 0 – 9 )**

**Dial and press the selected digit.**

**Note:** Finland, dial \* 5 1 \* ( 1 – 9 ).



**Press and dial the phone number.**



**Press.**

**Note:** The programmed number may consist of a maximum of 20 digits plus \*, which indicates the second dial tone from the public network.

**# 5 1 \* ( 0 - 9 )**



To erase one programmed number:

**Dial and press the selected digit.**

**Note:** *Finland, dial # 5 1 \* ( 1 - 9 )*

**Press.**

To erase all programmed numbers:

**# 5 1 #**



**Dial.**

**Press.**

**Dial by a function key**

Both functions and phone numbers can be programmed on a function key. To program a key, see section "[Programming of function keys](#)" on page 69.

*Head office*



**Press the function key.**

This function key is preprogrammed by you.

## Authority

### Data privacy

Data privacy allows you to make a call without any disturbances, i.e. Intrusion. This function is automatically cancelled when the call is finished.



To order:

**Lift the handset.**

**\*41#**

**Dial and enter the number.**

**Authorization code, common (optional)**

If you are assigned to use a common authorization code (1 to 7 digits) you can temporarily change any used phone within the exchange to the authority level connected to this code. You can use the code for one call only or you can open the phone to some calls and lock it when leaving the phone.

To use for a single call:

**\*72\***

**Dial.**

⓪⓪⓪  
⓪⓪⓪  
⓪⓪⓪  
⓪

**#**

**Enter authorization code and press.**

Verification tone.

⓪⓪⓪  
⓪⓪⓪  
⓪⓪⓪  
⓪

**Dial the digit or digits to get an external line and the external number.**

To open an extension for some calls:

**#73\***

**Dial.**

⓪⓪⓪  
⓪⓪⓪  
⓪⓪⓪  
⓪

**#**

**Enter authorization code and press.**

Verification tone.

To lock an extension:

**\*73\***

**Dial.**

⓪⓪⓪  
⓪⓪⓪  
⓪⓪⓪  
⓪

**#**

**Enter authorization code and press.**

Verification tone.

**Authorization code, individual (optional)**

If you are assigned to an individual authorization code (1 to 7 digits, affiliated to your own extension) you can lock your own extension to a common authority level, e.g. when out of the office. You can also temporarily change any other used phone within the exchange to the same authority level as you have on your own phone. The individual code can be changed from your own extension.

To lock your phone:

**\* 7 6 \***

**Dial.**

⦿⦿⦿  
⦿⦿⦿  
⦿⦿⦿  
⦿

**#**

**Enter authorization code and press.**

Verification tone.

To make calls with your authority level when your phone is locked:

**\* 7 5 \***

**Dial.**

⦿⦿⦿  
⦿⦿⦿  
⦿⦿⦿  
⦿

**#**

**Enter authorization code and press.**

Verification tone.

⦿⦿⦿  
⦿⦿⦿  
⦿⦿⦿  
⦿

**Dial the digit or digits to get an external line and the external number.**

To open your phone:

**# 7 6 \***

**Dial.**

⦿⦿⦿  
⦿⦿⦿  
⦿⦿⦿  
⦿

**#**

**Enter authorization code and press.**

Verification tone.

To assign your own authority level to another phone:

**\*75\***

**Dial.**

⓪⓪⓪  
⓪⓪⓪ \*  
⓪

**Enter authorization code and press.**

Verification tone.

⓪⓪⓪  
⓪⓪⓪ #  
⓪

**Dial your own extension number and press.**

Verification tone.

⓪⓪⓪  
⓪⓪⓪  
⓪⓪⓪  
⓪

**Dial the digit or digits to get an external line and the external number.**

To change your individual authorization code:

**\*74\***

**Dial.**

⓪⓪⓪  
⓪⓪⓪ \*  
⓪⓪⓪  
⓪

**Enter old authorization code and press.**

⓪⓪⓪  
⓪⓪⓪ #  
⓪

**Enter new authorization code and press.**

Verification tone.



## During Calls

### Group listening (loudspeaking)

This function lets other people in your room listen to your phone conversation. You speak in the handset while the other party's voice is heard on the loudspeaker.



During an ongoing conversation:

#### **Press to switch between loudspeaker and handset.**

When the key lamp is lit, the other party's voice is heard on the loudspeaker.

**Note:** You can adjust the volume, See section "[Settings](#)" on page 69.

### From loudspeaking to handsfree

(Dialog 4222 Office phone only).



#### **Replace the handset.**

Handsfree conversation.

### From handsfree to loudspeaking

(Dialog 4222 Office phone only).

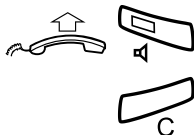

#### **Lift the handset and press.**

**Press to end the call.**

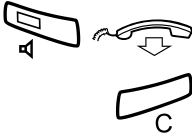

## Handsfree

*(Dialog 4222 Office phone only).*

**Press and replace the handset.**  
Handsfree conversation.

**Press to end the call.**



### From handsfree to handset

**Lift the handset.**  
Conversation via the handset.



## Mute

**Press to switch the microphone on or off.**  
When the lamp is lit, the person on the line cannot hear what is being said in your room.



**Inquiry**

## Inquiry

You have a voice connection on Line 1 and want to make an Inquiry to an internal or external party.

**Press.**  
The first party is put on hold (Line 1 flashes slowly).

**Note:** *You can also press Line 2.*



**Call the third party.**  
When the other party answers, you can switch between the calls (Refer back), Transfer the call, create a Conference and end one of the calls.



**Press to end the Inquiry call.**  
The third party is disconnected.



**Line 1**

**Press to return to the first call.**

### Refer back

The Line key lamp flashes for the call put on hold.



#### **Press to put third party on hold.**

First call is connected.



#### **Press to put first call on hold.**

Third party is connected.



**Note:** You can also press Line 2 if you have initiated the Inquiry on Line 2.

#### **Press to terminate the connected call.**

## Transfer

You have an ongoing call and you want to transfer the call to another extension.



#### **Press.**

**Note:** You can also press a free Line key.



#### **Call the third party.**



#### **Press before or after answer.**

The ongoing call is transferred.

**Note:** If you have put more than one call on hold, the last call that was put on hold will be transferred. If the dialed extension is busy or Transfer is not allowed, your phone will ring again.

## Conference

With this procedure you can include up to seven parties in a conference. Only the conference leader (i.e. the person initiating the conference) can admit participants. During the conference a tone will be heard every 15th second.

**Note:** *The conference tone might be disabled for your system.*

You have an ongoing conversation (Line 1) and want to establish a phone conference. You will become the conference leader.



**Inquiry**

**Press.**

**Note:** *You can also press Line 2 or Inquiry.*



**Call the third party.**

Wait for answer.

**3**

**Press to establish a conference.**

**Note:** *You can also press: Conference (function key preprogrammed by you).*

**Repeat the procedure to add more conference members.**



**Replace the handset to leave the conference.**

**Note:** *A tone burst is heard each time a participant enters or leaves the conference. When the conference leader leaves the conference, the conference will continue with the other included parties. The conversation is changed back to a normal two party connection when there is only two parties left.*

## On hold

You can temporarily put the ongoing call on hold. Calls put on hold can be resumed on your own or on another phone.



**Line**

### Individual

**Press the ongoing call Line key and replace the handset.**

The key lamp flashes slowly.



**Line**

**Press the flashing Line key again to resume the call.**

### Common

**8**

**Press**

#### **Notes:**

*You can also press: On hold/Pick-up (function key preprogrammed by you).*

*France, Press **4**; Sweden, Press **6***



**Replace the handset.**

The key lamp flashes slowly. If your number is multiple represented on other phones, the key lamp that represents your number flashes slowly on these phones.

To resume the call on your own extension:



**Line**

**Press the flashing Line key.**

To resume the call on another extension:



**Call the extension where the call was put on hold.**

**8**

**Press.**

#### **Notes:**

*You can also press: On hold/Pick-up (function key preprogrammed by you).*

*If your number is multiple represented on the phone, you can also press the key that represents your number.*

*France, press **4**; Sweden, press **6***

## Send caller identity code at transfer

When transferring a call you can send the caller's identity code or number to the receiver's display.

You have a voice connection with an external party on Line 1.



**Inquiry**

**Press to put the call on hold.**

**Note:** *You can also press Line 2.*

**\*77\***

**Dial.**

○○○  
○○○  
○○○  
○ #

**Dial the caller's identity code or number and press.**

○○○  
○○○  
○○○  
○

**Call the second party.**



**Transfer**

**Press before or after answer.**

The ongoing call is transferred with the caller's identity code or number.

**Note:** *You can only use this function if the receiver's phone is programmed to handle identity codes. This function is only available in newer versions of the exchange.*

---

## Dialing during a connected call

When calling interactive teleservices, e.g. telephone banks, you need to use Dual Tone Multi Frequency (DTMF) signals. If your exchange is not already programmed to automatically convert your entered digits into DTMF signals, you need to activate the function during the call.

During an ongoing call:

**9** ○○○  
○○○  
○○○  
○

**Press and dial the requested digits.**

Entered digits are transferred as DTMF signals.

**Note:** *Finland, press **1** and dial the required digits.*

# Call Forwarding

## Diversion

If you do not want to be disturbed or will be out of the office, you can have all calls to your extension diverted to a preprogrammed answering position. During Diversion you will hear a special dial tone and the Diversion lamp indicates that your Triple Access Line is diverted. You can still make calls as usual.

Diversion can be direct, on no answer, on busy or to another information service facility.

**Note:** *If your phone is programmed with "Multiple Directory Diversion and Do not disturb" (ask your system administrator), Diversion is ordered and cancelled simultaneously on all lines.*

### Order Direct Diversion from your own extension

The call is diverted to an individual position or up to three pre-determined common answering positions (depending on the type of the incoming call). Programmed by your system administrator.

**Note:** *Diversion can also be ordered and cancelled from the answering position, use the same procedure as in section "Internal Follow-me" on page 42.*

Diversion



**Press.**

**Note:** *Function key preprogrammed by your system administrator. If you order Diversion with the handset off hook or the loudspeaker on, press the Diversion key twice. You can also use the procedure below.*

✳ 2 1 #



**Dial and press.**

**Note:** *U.K., dial ✳ 2 #*

### Cancel Direct Diversion from your own extension

**Note:** Diversion can also be ordered and cancelled from the answering position, use the same procedure as in section "[Internal Follow-me](#)" on page 42.

Diversion 

**Press.**

**Note:** Function key preprogrammed by your system administrator. You can also use the procedure below.

**# 2 1 #**

**Dial.**

**Note:** U.K., dial **# 2 #**



**Press.**

### Diversion when there is no answer

**\* 2 1 1 #**

**Dial to order.**

**Note:** Finland and Norway, dial **\* 6 1 #**



The incoming call is diverted after 3 signals.

**Press.**

**# 2 1 1 #**

**Dial to cancel.**

**Note:** Finland and Norway, dial **# 6 1 #**



**Press.**



**Diversion when caller receives a busy tone****\*212#****Dial to order.****Note:** Finland and Norway, dial **\*67#****Press.****#212#****Dial to cancel.****Note:** Finland and Norway, dial **#67#****Press.****Diversion to paging****\*218#****Dial to order.****Press.**

**Note:** When Follow-me has been activated from your ordinary phone, you can re-divert calls to paging from the temporary answering position by adding \* and your extension number to the procedure, i.e. dial **\*218\*** your extension number **#** and press the Clear key. This function is only available in newer versions of the exchange.

**#218#****Dial to cancel.****Press.**

## Internal Follow-me

All calls to your extension are diverted to another extension of your choice (within the private network). The Follow-me lamp indicates that you have activated Follow-me. During Follow-me, your phone can still be used for outgoing calls and you will hear a special dial tone when you lift the handset.

**Note:** If your phone is programmed with "Multiple Directory Diversion and Do not disturb" (ask your system administrator), Internal Follow-me is ordered and cancelled simultaneously on all lines.

### Order from your own extension



**Lift the handset.**



**Press and enter the answering position number.**

**Note:** Function key preprogrammed by your system administrator.

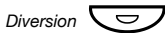

**Press to order.**



**Replace the handset.**

**Note:** You can also use the procedure below.

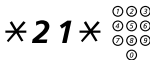

**Dial and enter the answering position number.**

**Note:** U.K., dial \* 2 \* No.

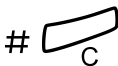

**Press.**

Diversion 

**Cancel from your own extension**

**Press.**

**Notes:**

*Function key preprogrammed by your system administrator.*

*You can also use the procedure below.*

# 2 1 # 

**Dial and press.**

**Note:** U.K., dial # 2 #

**Redirect from answering position**

If you move from one answering position to another answering position, you can redirect Follow-me from that new position.

**Note:** *Internal Follow-me must be ordered from your own extension before you can redirect from answering position.*

\* 2 1 \* 

**Dial and enter your own extension number.**

**Note:** U.K., dial \* 2 \* No.

\* 

**Press and enter the Diversion number.**

# 

**Press to redirect.**

*Calls are diverted to the answering position.*

**Cancel from answering position**

# 2 1 \* 

**Dial and enter your own extension number.**

**Note:** U.K., dial # 2 \* No.

# 

**Press.**

## External Follow-me

If external Follow-me is allowed you can have all calls to your extension diverted to an external number of your choice. The Follow-me lamp indicates that you have activated Follow-me. During Follow-me, your phone can still be used for outgoing calls and you will hear a special dial tone when you lift the handset.

\*22# 



### Order

**Dial and enter the digit or digits to get an external line and enter the external number.**

**Press.**

Diversion 

### Cancel

**Press.**

**Note:** *Function key preprogrammed by your system administrator. You can also use the procedure below.*

#22#



**Dial.**

**Press.**

## Personal Number (optional)

With this function you can be reached on your normal office phone number even if you are in another room, out of the office or at home, etc.

Depending on the functionality of your office exchange, you can have either one individual single search profile or you can choose between five individual search profiles.

A search profile can be designed to fit the situation, i.e. in the office, traveling, at home, etc. Both internal or external phone numbers can be used in a profile.

At your request, the search profiles are programmed or modified by your system administrator. See section "[To design and order your search profiles](#)" on page 47.

When the function is activated, incoming calls are transferred to different phones or to back-up services in the order you choose. If an answering position in the profile is busy, the call can be transferred to another predefined position in the profile, i.e. voice mail or a colleague. You can activate the function from your own office phone or when out of the office, by using the Direct Inward System Access function (DISA).

### To activate or change to another profile from your office phone

✳ 1 0 ✳

( 1 – 5 )

# 

**Dial.**

**Press the search profile digit.**

**Press.**

The display shows the chosen search profile digit.

#### **Notes:**

*You can also activate and change to another profile by programming one function key/search profile (the function keys has to be pre-assigned by your system administrator). When the search profile is active the key lamp is on. See section "[Settings](#)" on page 69.*

*When another party is included in the activated profile, a colleague or an operator, etc., always remember to inform about your absence. If voice mail is included in the activated profile, always update your greeting with absence information.*

# 1 0 #



**To cancel from your office phone**

**Dial.**

**Press.**

**Note:** If you have activated a profile via a function key, you can press this key instead of using the procedure above.

**To activate or change to another profile from an external phone**

The external phone must be of push button type provided with pound key (#) and star key (\*) or a mobile phone adapted for dial tone pulses (DTMF).



**Call the DISA function at your office.**

Dial tone.

\* 7 5 \*

**Dial.**



**Enter the authorization code and press.**



**Dial your own extension number and press.**

Dial tone.

\* 1 0 \*

**Dial.**



**Dial your own extension number and press.**

( 1 - 5 )

**Press the search profile digit.**



**Press and replace the handset.**

**Note:** When another party is included in the activated profile, a colleague or an operator, etc., always remember to inform about your absence. If voice mail is included in the activated profile, always update your greeting with absence information.

**To cancel from an external phone**

The external phone must be of push button type provided with pound key (#) and star key (\*) or a mobile phone adapted for dial tone pulses (DTMF).

**Call the DISA function at your office.**

Dial tone.

**\* 7 5 \***

**Dial.**



**Dial the authorization code and press.**



**Dial your own extension number and press.**

Dial tone.

**# 1 0 \***

**Dial.**



**Dial your own extension number and press.**



**Replace the handset.**

**To design and order your search profiles**

The search profiles are installed or changed by your system administrator. In order to set up your profiles, copy the setting form, fill in your new or changed profiles and give it to your system administrator.

**Note:** *If a profile handling application is connected to your system, you can edit profiles via your Intranet. See separate instructions for the application.*

Important notes when designing your search profiles:

- Avoid ring times longer than 45 seconds for your profiles.  
Usually the caller hangs up after 3-6 ring signals. If you need a longer ring time, the maximum time is 60 sec.
- Consider the time you need to react and answer on each answering position in your profile.  
You might need up to 15 seconds to react and answer a call on a desk or cordless phone and 20–25 seconds for a mobile phone.
- There must be an answering position at the end of every profile (Voice mail or operator/secretary).  
If not, calls might end up unanswered.
- Consider what should happen while you are busy on a phone.  
The available options are:
  - *Activate Free on 2nd (if available)*
  - *Diversion to voice mail*
  - *Diversion to the operator*
- If an answering machine, a fax or other answering device is used as an early answering position, it might interrupt the searching.  
Disconnect the answering device, or design the ring times so they do not affect the searching.
- If your system admits just one single personal profile, design the profile only with your 2–3 most frequently used positions.  
If you add more numbers, there is a risk that the caller hangs up before a latter position is called.
- If your system admits 1–5 personal profiles, design the different profiles to fit your most frequently used positions.  
Make sure you use as few answering positions as possible for each profile. Profile examples:
  - *In office*
  - *At home*
  - *Traveling*
  - *Absent/not reachable*



*Example:*

How to fill in your setting form for search profiles:

**Profile 1 In office**

Search order	Type of telephone or Answering position*	Telephone number	Ring time (seconds)
1	Desk	1234	10
2	Cordless	5234	15
3	Voice mail		

\* Examples: Desk, Cordless, Mobile, External, Voice mail, Operator, etc.

**Profile 2 At home**

Search order	Type of telephone or Answering position*	Telephone number	Ring time (seconds)
1	External	222222	20
2	Mobile	0706666666	25
3	Voice mail		

## Setting form for search profiles

Name:

Department:

Telephone No:

Account:

### Profile 1

.....

Search order	Type of telephone or Answering position*	Telephone number	Ring time (seconds)
1			
2			
3			
4			

\* Examples: Desk, Cordless, Mobile, External, Voice mail, Operator, etc.

### Profile 2

.....

Search order	Type of telephone or Answering position*	Telephone number	Ring time (seconds)
1			
2			
3			
4			

### Profile 3

.....

Search order	Type of telephone or Answering position*	Telephone number	Ring time (seconds)
1			
2			
3			
4			

### Profile 4

.....

Search order	Type of telephone or Answering position*	Telephone number	Ring time (seconds)
1			
2			
3			
4			

### Profile 5

.....

Search order	Type of telephone or Answering position*	Telephone number	Ring time (seconds)
1			
2			
3			
4			

## Absence Information (optional)

Absence information is used to inform callers why you are absent and when you return. If you are authorized, you can also enter absence information for another extension from your extension. During absence information, your phone can still be used for outgoing calls and you will hear a special dial tone when you lift the handset.

### Order

*Example: Back on September 15 (=0915).*

**\* 2 3 \***

**Dial.**

**( 0 – 9 )**

**Enter the absence code.**

**Note:** *The absence codes consist of one digit which depends on the system connected to the exchange. Contact your system administrator regarding the available absence codes.*

**\* 0 9 1 5**

**Press and enter the date (MMDD) or time (HHMM) of your return.**

**Notes:**

*If no return time or date is needed, this step can be skipped.*

*The order in which the date is stated is system dependent.*

# 

**Press.**

On the 4222 Office phone the display shows the reason, and if entered, time or date of return.

# 2 3 #



**Cancel**

**Dial.**

**Press.**

The programmed information is erased.

\* 2 3 0 \*



( 0 - 9 )

**Order for another extension**

**Dial.**

**Dial the extension number and press.**

**Enter the absence code.**

\* 0 9 1 5

**Press and enter the date or time of the other person's return.**



**Press.**

The display on the other person's extension shows the reason, and if entered, time or date of return.

**Cancel for another extension**

# 2 3 0 \*

**Dial.**



**Dial the extension number and press.**

**Note:** If the special dial tone is received, the authorization code for the other extension is required. Add the code and press # before pressing the Clear key.



**Press.**

# Messages

## Manual Message Waiting (MMW)

If the called extension does not answer you can initiate a message waiting indication on that extension (if this function is allowed). If there is a message waiting, the Message key lamp is on and you will hear a special dial tone after lifting the handset.

Message 

### Answer

**Press.**

**Note:** Function key preprogrammed by your system administrator.

A call is initiated to the extension that requested Message Waiting.

### Checking the party that requested MMW

(Dialog 4222 Office phone only).

 **Program**

**Press.**

The program key lamp turns on and all other lamps turn off.

Message 

**Press.**

**Note:** Function key preprogrammed by your system administrator.

The number that requested Message Waiting is shown in the display.

 **Program**

**Press to finish procedure.**

Cancel MMW at your own extension

# 3 1 #

Dial.



Press.

Order MMW to another extension

\* 3 1 \*

Dial.



Dial the extension number.



Press.

The Message Waiting key lights up on the called extension.

Cancel MMW to another extension

# 3 1 \*

Dial.



Dial the extension number.



Press.

## Message Waiting (optional)

If assigned this function and your phone is diverted to an interception computer, a function key (programmed by your system administrator) will flash when there are messages stored for you in the computer. The messages will be printed out on a printer connected to the computer.

Message 

### To print out messages

**Press.**

**Note:** *Function key preprogrammed by your system administrator.*

On the 4222 Office phone, the display shows the identity of the computer and the number of messages stored for you.

If you find that the notification of Message Waiting is intrusive or you want to shut off the notification:

**# 9 1 # \***

**Dial.**

Acknowledgement tone.

## Integrated voice mail (optional)

This function allows you to leave a voice message to the caller when you are unable to answer calls, e.g. when out of office, in a meeting, etc. The caller can then leave a message in your mailbox. When back in office you can enter your mailbox and listen to the messages received.

You can choose to divert all incoming calls to your mailbox, or calls when there is no answer, or calls when your phone is busy.

When you enter your mailbox, you will hear recorded instructions on how to handle listening, recording, storing and deleting messages, and how to change your security code.

### **To activate and deactivate your mailbox**

*For all incoming calls:*

See “[Diversion](#)” on page 39 (function code 21). Use the number to the voice mail system as the “answering position number”.

*When incoming calls get no answer:*

See “[Diversion](#)” on page 39 when there is no answer (function code 211).

*When incoming calls get a busy tone:*

See “[Diversion](#)” on page 39 when caller receives a busy tone (function code 212).



**To enter your mailbox**

From your office phone:



**Dial the number to the voice mail system.**

**Note:** *If a function key is programmed for your mailbox and the key lamp is lit or flashing (= a new message is received), you can also press this key.*

If you are asked to enter your security code:



**Enter your security code.**

Code at delivery = your extension number.

From another phone:



**Dial the number to the voice mail system.**

If you are asked to enter your security code (the used phone has a mailbox of its own):

**#**

**Press.**



**Dial your mailbox number.**

(normally your office extension number)



**Enter your security code (if required).**

**To enter someone else's mailbox**

**Dial the number to the voice mail system.**

If you are asked to enter your security code (the used phone has a mailbox of its own):

**#**

**Press.**



**Dial the mailbox number.**

(normally the office extension number of the other person)



**Enter the security code of the other person (if required).**

**To handle the mailbox**

Recorded information on the line tells you the number of new and stored messages. If you have too many messages stored, you will first be asked to delete saved messages.

Recorded instructions ask you to press different digits in order to listen to callers' messages, record your own greetings, change your password or exit your mailbox, etc.

The following diagram gives an overview of the mailbox system and the digits to be used.

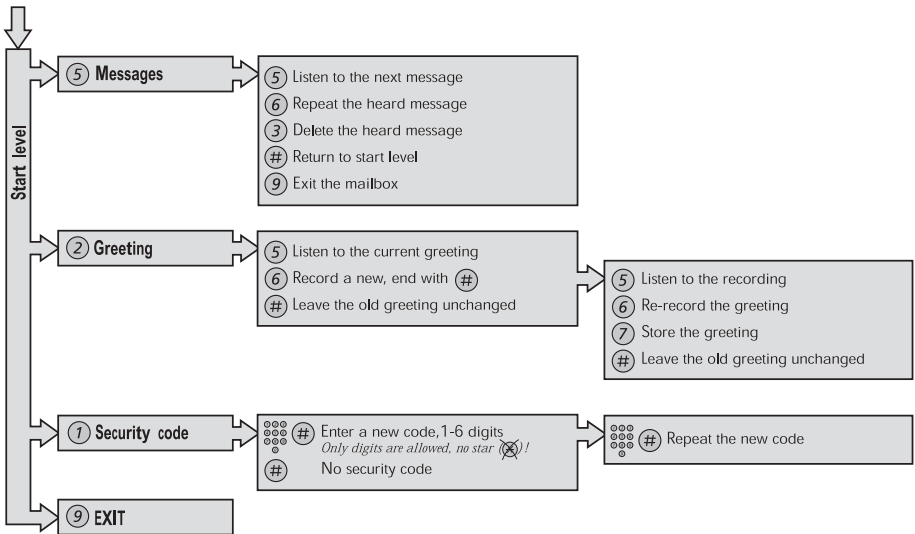

# Group Features

## Group Call-pick-up

People working in a team can have their phones programmed by their system administrator to form Call Pick-up groups.

In a Call Pick-up group, any member can answer any individual call to group members.

### **8** Press to answer.

**Notes:**

*One Call Pick-up group can serve as an alternative to another group. Calls to the alternative group can only be answered when there are no calls to your own group.*

*Finland and Sweden, press **0***

---

## Common bell group

Calls are signalled on a common bell.

### **8** Press to answer.

**Note:** *Finland and Sweden, press **0***

## Group Hunting

An internal Group Hunting number is a common directory number for a group of extensions. Calls to the group will be indicated at a free extension in the group.

When you leave the group temporarily, you make your phone unavailable for incoming calls.

\* 2 1 \* 

# 

### To leave the group temporarily

**Dial and enter your own extension number.**

**Note:** U.K., dial \* 2 \* No.

**Press.**

# 2 1 #



### To re-enter the group

**Dial.**

**Note:** U.K., dial # 2 #

**Press.**

If you are authorized you can divert all calls to your group, to another extension or group:

\* 2 4 \*

 \*

**Dial the number of the group to be diverted and press.**



**Dial the extension number of the new answering position.**

# 

**Press.**

# 2 4 \*

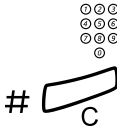

To cancel the Diversion:

**Dial.****Dial the number of the group that has been diverted.****Press.**

## Group Do not disturb

If your extension is defined as a master extension (programmed by your system administrator), you can mark a group of extensions as Group Do not disturb. The group can be bypassed by you.

\* 2 5 \*



To order:

**Dial and enter the group number.****Note:** *Germany and South Africa, dial \* 2 8 \* No.***Press.**

Special dial tone.

**Press.**

To cancel:

# 2 5 \*

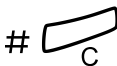
**Dial and enter the group number.****Note:** *Germany and South Africa, dial # 2 8 \* No.***Press.**

To bypass:

\* 6 0 \*

#

**Dial and enter the extension number.****Press.**

The call is made to the specified extension in the group.

## Other Useful Features

### Account code (optional)

This function is used to charge a call to an account number or to prevent unauthorised calls from your phone. The account code can have 1 to 15 digits.

**\* 6 1 \***

**Dial.**

**Note:** *Finland and Norway, dial \* 7 1 \**



**Dial the account code and press.**

Dial tone.



**Dial the digit or digits to get an external line and the external number.**

#### Ongoing external call

When used to charge a call it is also possible to connect an ongoing external call to an account code. During the call:



**Line**

**Press the ongoing call Line key to put the call on hold.**

**\* 6 1 \***

**Dial.**

**Note:** *Finland and Norway, dial \* 7 1 \**



**Dial the account code and press.**

Dial tone.



**Line**

**Press the flashing Line key for the call put on hold.**

## Immediate Speech Connection

On the 4222 Office phone, calls are automatically answered without lifting the handset or pressing any keys. The call starts in handsfree mode.

On the 4220 Lite phone, calls are automatically answered and the caller can leave a message over the built-in loudspeaker. To answer the call you have to lift the handset.

The function can be permanently active or activated by use of a function key (programmed by your system administrator).

### Permanently active

Program the ringing option with “Immediate Speech Connection with one ring signal”, option 6, on the Line key. See section “Settings” on page 69.

### Activated on a function key

Automatic answer



**Press to order or cancel.**

**Note:** *Function key preprogrammed by your system administrator.*

The incoming call is signalled with one ring signal. When the key lamp is lit you can use this function.

## General Deactivation

The following features can be simultaneously cancelled:

- Callback (all Callbacks are cancelled).
- Diversion/Internal and External Follow-me.
- Manual Message Waiting/Message Diversion.
- Do not disturb.

# 001 #



**Order**

**Dial.**

**Press.**

---

## Night Service

When the exchange is in Night Service mode, all your incoming calls to the operator are transferred to a selected extension or group of extensions. The exchange is equipped with three different Night Service modes:

### **Common Night Service**

All incoming calls to the operator are transferred to one specific extension. Answer the call in the normal way.

### **Individual Night Service**

Selected external calls to the operator are transferred to one specific extension. Answer the call in the normal way.

### **Universal Night Service**

All incoming calls to the operator are transferred to a universal signalling device, e.g. the common bell. Answer the call as described in section "[Common bell group](#)" on page 59.



## Hot line

Ask your system administrator if you require this function.

### Delayed Hot line

When the handset of the delayed Hot line phone is lifted or when the Line key is pressed, a timer is started. If no digit is pressed before time out, a call is automatically generated to a specific extension or external line. If a digit is pressed before time out the phone works as an ordinary phone.

**Note:** *This function is only available in newer versions of the exchange.*

### Direct Hot line

The same function as described above, but without a delay. Only Hot line calls can be placed from this line. To be used e.g. as alarm phone, door phone etc.

---

## Alarm extension

An extension can be programmed by your system administrator as an Alarm extension. A call to an Alarm extension obtains automatic Intrusion if the extension is busy. Up to seven calling parties may be connected at the same time.

---

## Emergency mode

In the event of an emergency, the operator can set the exchange into Emergency mode, during which only preprogrammed extensions are permitted to make calls. If your extension is not assigned with this category and you try to make a call, you will not receive a dial tone.

## Data communication

Your Phone can be used together with a PC as an integrated voice and data terminal. Contact your System Administrator if you require this Function.

---

## Additional directory number

You can be assigned (programmed by your system administrator) one or more Additional Directory Numbers (lines) on free function keys.

To answer, make calls and use functions on the additional directory lines, use the same procedure as for the Triple Access Lines if nothing else is stated. However, you have to press the additional Line key after lifting the handset.

*Example:*

To make a call on an additional directory line:

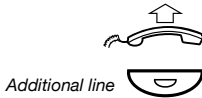

**Lift the handset.**

**Press.**

**Note:** Function key preprogrammed by your system administrator.



**Dial the extension number.**

## Multiple represented directory number

Your extension number can be programmed on a dedicated key on other system telephones, i.e. the number is “represented” on these phones.

This means that incoming calls to your extension can be answered on any of these other phones by just pressing the dedicated key. The dedicated key can also be assigned the possibility to call your extension when pressed. This function has to be programmed by your system administrator.

---

## Malicious Call Tracing

If you are disturbed by bothersome or malicious external incoming calls, you can request number tracing from the network provider.

You can invoke tracing during or after an ongoing conversation. The external line can be held for a limited period of time.

### Order

During an ongoing conversation:

Mal. Call Tracing



**Press.**

**Note:** *Function key preprogrammed by your system administrator.*

The system acknowledges with different tones whether the tracing request was accepted or rejected.

## DISA = Direct Inward System Access (optional)

If you are assigned to use this function and you are working externally, you can call your office and get access to an external line in order to make business calls. The business call will be charged your office extension number or an account number. You will just be charged for the call to the office.

The external phone must be of push button type provided with pound key (#) and star key (\*) or a mobile phone adapted for dial tone pulses (DTMF).

After a completed DISA call you must hang up before a new DISA call can be made.

There are different procedures depending on the type of authorization code, or when an account code is used.

### With common authorization code



**Call the DISA function at your office.**

Dial tone.

**\* 7 2 \***

**Dial.**



**#**

**Dial the authorization code and press.**

Dial tone.



**Dial the external number.**

### With individual authorization code



**Call the DISA function at your office.**

Dial tone.

**\* 7 5 \***

**Dial.**



**\***

**Dial the authorization code and press.**



**#**

**Dial your own extension number and press.**

Dial tone.



**Dial the external number.**

# Settings

## Programming of function keys

Frequently used functions and phone numbers can be programmed on the function keys for easy access. When you want to use the function, just press the key. Certain functions must be preprogrammed by your system administrator. Both phone numbers and function codes can be programmed on a function key.

### Program or change a function



**Press.**



**Press selected function key.**

**Note:** If the key is already programmed, the number or function will be displayed.



**Enter phone number or a function code according to the list in section “Functions and required data”.**

**Note:** If a wrong number is entered, press the Clear key to erase it, and then enter the number again.



**Press the function key again.**



**Press to finish programming.**

Remove the transparent cover and write the function name or phone number beside the key.

**Notes:** To erase a programmed function, press the Clear key, instead of the phone number or function code, in the programming sequence.

Use the DCM (Designation Card Manager) to make and print your own designation cards. DCM is included on the Telephone Toolbox CD for MD110 Communication System or it can be downloaded from:

<http://www.ericsson.com/enterprise/library/manuals.shtml>

For more information, please contact your Ericsson Enterprise certified sales partner.

### To verify and erase programmed number or function



**Press.**



**Press the selected function key.**

On the 4222 Office phone, the stored number is shown on the display.



**Press if you want to erase the stored number.**

The stored number is erased.



**Press.**

## Functions and required data

<i>Function</i>	<i>Function code or Associated number</i>			
	Most common	Finland	France	Sweden
Call pick up:				
Group	<b>8</b>		<b>4</b>	<b>6</b>
Individual	No. + <b>8</b>		No. + <b>4</b>	No. + <b>6</b>
Call Waiting	<b>5</b>	<b>6</b>	<b>6</b>	<b>4</b>
On hold, common	<b>8</b>		<b>4</b>	<b>6</b>
Conference	<b>3</b>			
Dial by a function key	Extension No.			
Intrusion on busy extension	<b>4</b>		<b>8</b>	<b>8</b>
Last External Number Redial	***	**0		**0
Personal Number (list no.)	<b>(1-5)</b>			

Functions that need to be programmed by your system administrator:

- Additional lines
- Dedicated intercom link
- Do not disturb\*
- Free on 2nd
- Individual external line
- Manual Message Waiting
- Search profile lists and pre-assigning of function keys for Personal Number
- Callback\*
- Diversion\*
- External line
- Immediate Speech Connection\*
- Malicious Call Tracing
- Multiple representation

*\*Function can be programmed by you.*

When the function is programmed *by you*, you *will not* get a toggle function. Instead you will have one key for activation and another key for deactivation. The key lamp will *not* indicate that the function is activated.

When the function is programmed *by your system administrator* you *will get* a toggle function and the key lamp will indicate that the function is activated.



## Programming of ring signals

You have 6 programmable ring signals on your phone. The different signals can be programmed on lines, additional lines and multiple represented lines.



**Program**

**Press.**



**Line 1**

**Press the corresponding Line key.**

On the 4222 Office phone, a digit (0–6) is shown in the display.

**(0–6)**

**Select the ring signal you want to use according to the list below.**

- 0 = Silent.
- 1 = Periodic ring signal.
- 2 = Delayed periodic ring signal.
- 3 = One muted ring signal.
- 4 = One muted delayed ring signal.
- 5 = Immediate Speech Connection with one ring signal controlled by function key.
- 6 = Immediate Speech Connection with one ring signal.

**Note:** *Options 5 and 6 are not available for multiple represented lines.*



**Line 1**

**Press.**



**Program**

**Press to finish programming.**

### To verify a ring signal

*(Dialog 4222 Office phone only).*



**Program**

**Press.**



**Line 1**

**Press the corresponding Line key.**

A digit (0–6) is shown in the display.



**Program**

**Press to finish programming.**

## Programming of ring signal tone character

There are 10 different programmable ring signal tone characters on your phone, each corresponding to a digit between 0 and 9.

**Note:** *If you use melodies to signal incoming calls (4222 Office phone only), this will replace the tone character. See section “Melody ringing” on page 77.*



**Program**

**Press.**

On the 4222 Office phone, the current tone character is displayed.

**( 0 – 9 )**

**Press the corresponding digit.**

The phone rings with the chosen character.



**Program**

**Press to finish programming.**

## Handset and loudspeaker volume

Use the Volume keys to change the volume of the handset or loudspeaker during a call. Adjust the handset listening volume when the handset is off hook. Adjust the loudspeaker volume when dial tone is heard via the loudspeaker, or for Dialog 4222 Office also during a handsfree call.



### Press to change the volume.

On the Dialog 4222 Office phone, a volume symbol is shown for a few seconds (replacing your extension number). The handset and loudspeaker volume level is stored.

To adjust the volume during Group listening:



### Replace the handset.



### Press to change the volume.

On the Dialog 4222 Office phone, a volume symbol is shown for a few seconds, instead of the number. The handset and loudspeaker volume level is stored.



### Lift the handset and press.

For people with impaired hearing, the handset hearing volume level can be extra amplified. To change the level:

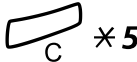

### Press simultaneously for at least 1 sec.

A tone signal is heard, and the display on the 4222 Office phone shows *Settings Mode*.



### Press to set or reset the volume level.

Key lamp on indicates amplified volume level. Key lamp off indicates default volume.



### Press to finish setting.

When extra amplification has been selected, the Line 1 key lamp turns off.

**Note:** A level change also effects a headset connected to the headset outlet.



## Ring signal volume

Use the Volume keys to adjust the ring signal volume when the phone is idle or ringing. Adjusted volume is stored.

### **Press to change the volume.**

On the Dialog 4222 Office phone, a volume symbol is shown for a few seconds (replacing your extension number).

---



## Mute ring signal

You can suppress the ring signal for an incoming call.

### **Press to suppress the ring signal.**

The ring signal is switched off for the current call, and your phone is automatically set to silent ringing (see below).

---

## Silent ringing

If you do not want to be disturbed by the ring signal but still want to be able to answer an incoming call, you can switch off the ring signal. Incoming calls are only indicated by a flashing line lamp and display information.



When the phone is in idle mode, or when ringing:

### **Press to switch off the ring signal.**

The Mute key lamp is switched on to indicate silent ringing. The ring signal will automatically be switched on the next time you lift the handset or press any key.

## Melody ringing

*(Dialog 4222 Office phone only).*

If you want to replace the ring signal with personal melodies when your phone rings, you can program one melody to signal an internal call, a second melody for an external call and a third melody to signal a Callback call.

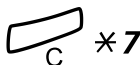

**Press and hold simultaneously to enter melody mode.**

Melody Mode

If there is a stored and activated melody for internal calls (Line 1), external calls (Line 2) or Callback calls (Inquiry), the corresponding key lamp is switched on.

In melody mode you can:

- Program new melodies
- Edit or delete stored melodies
- Activate or deactivate stored melodies

**#**

**Press to exit melody mode.**

**Note:** *If you do not press any key within 30 seconds, melody mode is automatically cancelled.*

**Program a new melody, edit or delete a current melody**



**Program**

**Press.**



**Press the key for the requested type of call:**

If there is a current melody, the melody is played and the last 19 notes or signs are displayed.



**Line 1**

**Press for internal calls,**

**or**



**Line 2**

**press for external calls,**

**or**



**Inquiry**

**press for Callback calls.**



To edit the current melody:

**Press to move the cursor to the right of the position to be edited.**

Keep pressed to go to the beginning or to the end.

**Press to erase the note to the left of the cursor.**

Keep pressed to erase all the notes.

To enter a new melody or new notes, see section [“To enter notes”](#) on page 80.

To store the current melody:



**Line**

**Press the flashing Line key (Line 1 or Line 2 or Inquiry).**



**Program**

**Press.**

The current melody is stored.

**Note:** *The melody is not activated, see section [“Activate or deactivate a stored melody”](#) on page 79.*



To Delete the current melody:

**Press and hold until no notes are displayed.**



**Line**

**Press the flashing Line key (Line 1 or Line 2 or Inquiry).**



**Program**

**Press.**

### Activate or deactivate a stored melody

A stored melody has to be activated in melody mode to be heard when you get an incoming call.

To activate (in melody mode):



**Line**

**Press the key for the requested type of call (Line 1 or Line 2 or Inquiry).**

The corresponding key lamp is switched on:

Line 1 key = Internal calls

Line 2 key = External calls

Inquiry key = Callback calls

**Note:** *If you want to return to an ordinary ring signal but keep the melody stored, just press the key for the requested type of call again. When the key lamp is off the stored melody is deactivated.*



**Press to exit melody mode.**

1c 2d 3e  
 4f 5g 6a  
 7b 8+c 9+d

**To enter notes**

In melody mode, the key pad is used to enter notes, pauses, etc. A maximum of 40 notes can be programmed for incoming calls, and 20 notes for recalls.

This is how the keys are used:

**Press to insert notes (1–9).**

**Note:** A short press gives a short note, a long press gives a long tone (displayed by a capital letter), +c and +d means the higher octave.

✱

**Press to insert a short pause (p).**

Hold to get a long pause (P). Repeat to get a longer pause (pp...p).

0

**Press to get a higher octave for the inserted note.**

A + is shown in front of the note to indicate the higher octave.

Example: 30 to get +e

#

**Press to increase or decrease the pitch for the inserted note.**

Press once for sharp pitch, twice for flat pitch and three times to get the normal pitch.

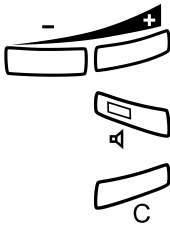

**Press to move the cursor to the left or to the right.**

Keep pressed to go to the beginning or to the end.

**Press to listen to the entered notes.**

**Press to erase the note to the left of the cursor.**

Keep pressed to erase all the notes.

Melody example:

James Bond theme programmed for internal calls:

C d d D D pp C C C C #d #d #D #D pp D D D ##A G pppp G F G

**Enter the notes.**

Grey digit = Long press.

1 2 2 2 2 ✱ ✱ 1 1 1  
 1 2 # 2 # 2 # 2 #  
 ✱ ✱ 2 2 2 6 # # 5  
 ✱ ✱ ✱ ✱ 5 4 5

**Note:** The # Key (to get a sharp or flat tone) is pressed after the note, but is displayed before the note.



When the first 19 positions are entered, the display shows (only last entered 19 positions can be shown):

```
Program Intern
CddDDFFCCCC#d#d#D#D<
```

When all the notes are entered, the display shows (only last entered 19 positions are shown):

```
Program Intern
#D#DFFDDDbAGFFFFGFG<
```

**Note:** The flat A (##A) is shown as bA, i.e. b is used to show both the note b and the flat sign.

## Display contrast

(Dialog 4222 Office phone only).

You can adjust the contrast for the display.

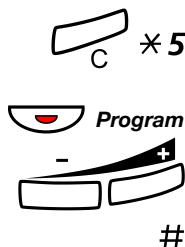

**Press and hold simultaneously until a ring signal is heard.**

The display shows **Settings Mode**.

**Press.**

**Press repeatedly to adjust the contrast.**

**Press to save and exit.**

**Note:** To exit the menu without saving the changes, press **#** before you press any of the adjustment keys.

# Accessories

## Key panel (optional)

*(Dialog 4222 Office phone only).*

In newer versions of the exchange, your phone can be equipped with one additional key panel. The key panel offers 17 additional keys for storing of your most frequently used telephone numbers and functions, and for supervising extensions. If you do not know which version of the exchange you are using, ask your system administrator. How to install the key panel, see section "[Installation](#)" on page 88.

**Note:** *The key panel must be of type DBY 419 01.*

Use the DCM (Designation Card Manager) to make and print your own key panel designation cards. DCM is included on the Telephone Toolbox CD for MD110 Communication System or it can be downloaded from: <http://www.ericsson.com/enterprise/library/manuals.shtml>

For more information, please contact your Ericsson Enterprise certified sales partner.

## Headset (optional)

(Dialog 4222 Office phone only).

How to install the headset, see section “[Installation](#)” on page 88. The following headset functions are available.

### Answer calls



#### **Press to answer.**

The Headset key lamp is turned on.

**Note:** When the phone is set for Headset Preset, you can also press the flashing line key to answer the call. See section “[Headset Preset](#)” on page 84.



#### **Press to terminate the headset call.**

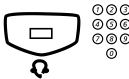

### Make calls

#### **Press and dial the number.**

The Headset key lamp is turned on.

**Note:** When the phone is set for Headset Preset, you can also dial the number directly without pressing the Headset key, or press a Line key instead of the Headset key. See section “[Headset Preset](#)” on page 84.



#### **Press to terminate the call.**



### From headset to handset

#### **Lift the handset.**

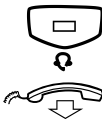

### From handset to headset

#### **Press.**

The Headset key lamp is turned on.

#### **Replace the handset.**



### **Headset with Group listening (loudspeaking)**

**Press to toggle between headset with or without Group listening.**

When the Loudspeaker key lamp is on, the Group listening is active.



### **From headset to handsfree**

**Press.**

The Loudspeaker key lamp is turned on.



**Press.**

### **From handsfree to headset**

**Press.**

The Headset key lamp is turned on.



### **Headset Preset**

By default the phone is set for calls to be connected to the loudspeaker when you answer or make calls by pressing a Line key, so called **Loudspeaker Preset**. Also when you dial the number without lifting the handset, the call is automatically connected to the loudspeaker.

When you use a headset for your telephone, you can change the setting to get calls connected to the headset instead, so called **Headset Preset**. In Headset Preset mode you can make headset calls by pressing digits directly (direct dialling). You can also answer headset calls by pressing a Line key.

#### **Notes:**

*Independent the type of preset setting, when you lift the handset, the call is always connected to the handset.*

*Also handsfree and loudspeaking work as usual, i.e. when the Loudspeaker key is pressed, the call is temporarily connected to the loudspeaker.*

*Activation and cancellation of Headset Preset can only be done when the telephone is in idle mode.*

To activate Headset Preset:



**Press and hold for at least 4 seconds.**

A short acknowledgement tone signal is heard, and the headset key lamp flashes for a few seconds.

To cancel Headset Preset:



**Press and hold for at least 4 seconds.**

A short acknowledgement tone signal is heard, and the loudspeaker key lamp flashes for a few seconds.

To check the current preset setting:



**Press.**

Either the Loudspeaker or Headset key lamp is turned on, indicating the current preset setting.

**Press.**

**Headset volume**

Use the Volume keys to change the volume of the headset.



**Press to change the volume.**

On the Dialog 4222 Office phone, a volume symbol is shown for a few seconds (replacing your extension number). The set headset volume level is stored.

To adjust the volume for the loudspeaker of the phone during Group listening:

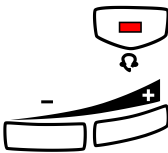

**Press.**

**Press to change the volume.**

On the Dialog 4222 Office phone, a volume symbol is shown for a few seconds (replacing your extension number). The loudspeaker volume level is stored.

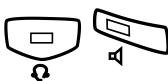

**Press.**

For people with impaired hearing, the headset hearing volume level can be extra amplified, use the same procedure as in section [“Handset and loudspeaker volume”](#) on page 75.

## Extra handset (optional)

*(Dialog 4222 Office phone only).*

The extra handset is used in parallel with the ordinary handset allowing another person to listen to an ongoing call. The extra handset is connected to the headset outlet under the phone, see section “[Installation](#)” on page 88.

It is possible to switch between the speaking party and the listening party.



### **Press to switch between the speaking and listening party.**

**Note when speaking:** *Due to speech quality, only one person at the time shall speak.*

---

## Pull-out leaf (optional)

The pull-out leaf is used for a personal telephone number list and is installed under the phone. How to install the pull-out leaf, see section “[Installation](#)” on page 88.

Use the DCM (Designation Card Manager) to make and print your own card for the pull-out leaf. DCM is included on the Telephone Toolbox CD for MD110 Communication System or it can be downloaded from: <http://www.ericsson.com/enterprise/library/manuals.shtml>

For more information, please contact your Ericsson Enterprise certified sales partner.

## Option unit (optional)

(Dialog 4222 Office phone only).

The option unit DBY 420 01/1 is an optional accessory to be installed under your telephone set. The unit is used to connect either an extra bell outside your room, or a busy signal lamp outside your door.

### To check or set the option unit for extra bell or for busy signal

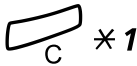

#### **Press and hold simultaneously until a ring signal is heard.**

The display shows OPTION PROGRAMMING and the Line 2 key lamp indicates the setting of the option unit:

Off=Extra bell, On=Busy signal lamp. Flashing=Combined extra bell & busy lamp.

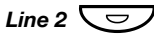

**Press to change to busy signal,**

**or**

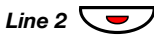

**press to change to extra bell & busy signal,**

**or**



**press to change to extra bell.**

**#**

**Press to save the setting and exit.**

**Note:** If you do not press **#**, the phone automatically returns to idle about 30 seconds after the last key press.

# Installation

## Install cables

Handset cable to the left

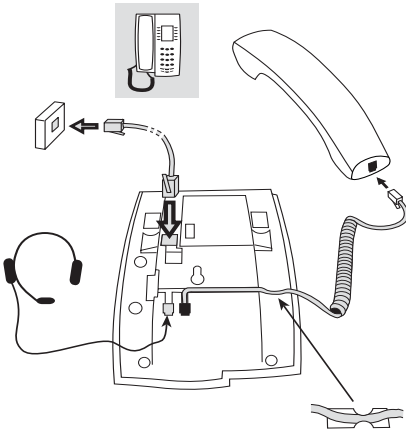

Handset cable to the right

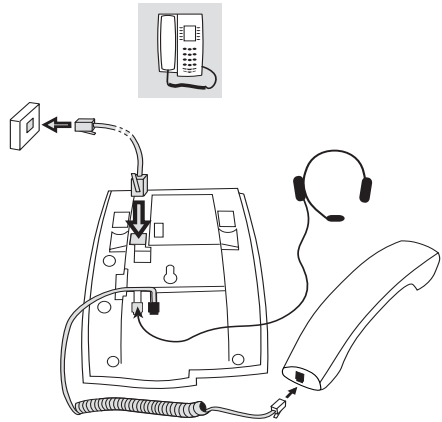

You can put the cable to the handset in the notch underneath the telephone. The cable to the exchange has to be plugged in "LINE" and the handset cable has to be plugged in "HANDSET".

**Note:** *The headset is for use with the Dialog 4222 Office phone only.*

### **Change cables**

To remove a cable, use a screwdriver to unlock the stop.



## Install stands and adapt telephone

Position high

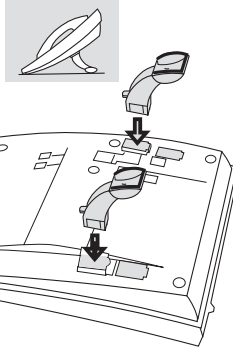

Position low

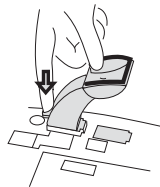
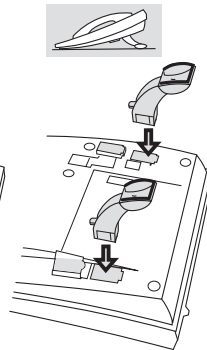

Press to fasten stand

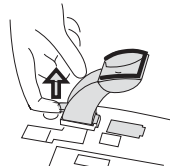

Release to remove stand

## Install card

Use the DCM (Designation Card Manager) to make and print your own designation cards. DCM is included on the Telephone Toolbox CD for MD110 Communication System or it can be downloaded from: <http://www.ericsson.com/enterprise/library/manuals.shtml>

For more information, please contact your Ericsson Enterprise certified sales partner.

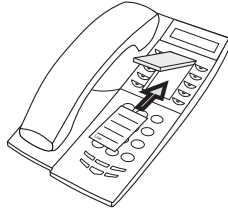

## Install key panel (optional)

*(Dialog 4222 Office phone only).*

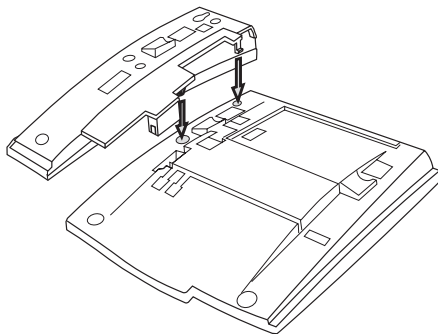

**1 Attach the key panel unit.**

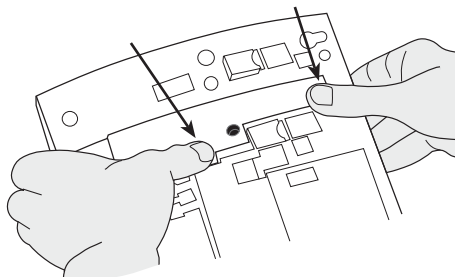

**2 Press hard where the arrows are pointing, until you hear the “Click” sound.**

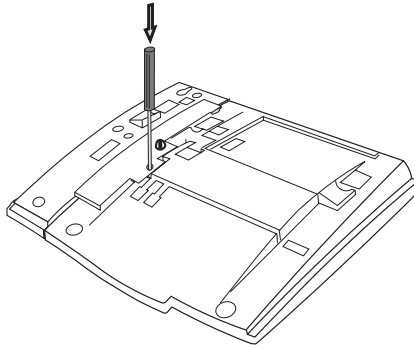

- 3 Use a screwdriver and press hard in the bottom of the hole, until you hear a weak sound.**
- 4 Install the stands as shown in picture “Stand positioning”.**

**Note:** *The key panel must be of type DBY 419 01, and it can only be used in newer versions of the exchange.*

### **Stand positioning**

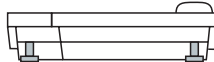

### **Install card**

Use the DCM (Designation Card Manager) to make and print your own key panel designation cards. DCM is included on the Telephone Toolbox CD for MD110 Communication System or it can be downloaded from: <http://www.ericsson.com/enterprise/library/manuals.shtml>

For more information, please contact your Ericsson Enterprise certified sales partner.

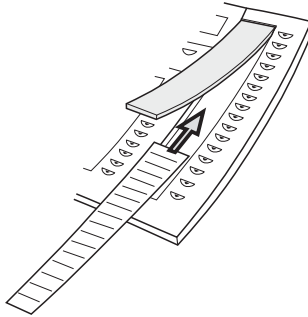

## Install pull-out leaf (optional)

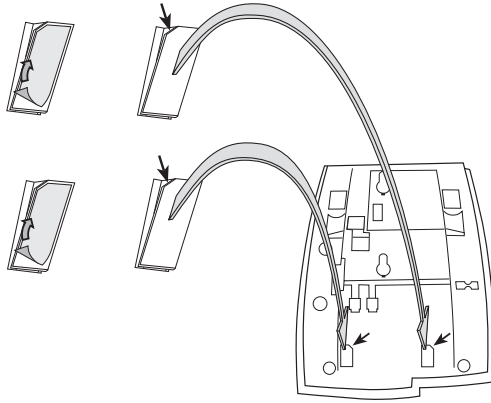

- 1 Remove the protective film from the guiding rails.**
- 2 Attach the guiding rails to the bottom of the phone, observing the direction of the “cut” corner.**

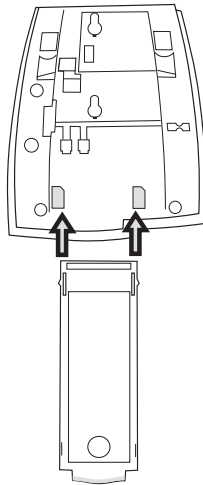

- 3 Insert the pull-out leaf.**

## Wall mounting

The phone can be wall mounted without using a special console. Useful for instance in conference rooms or public areas.

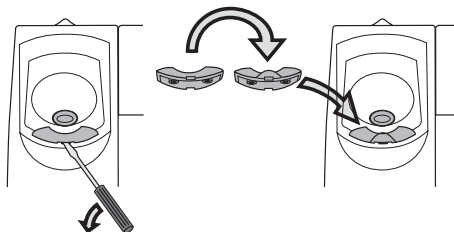

- 1 Use a screwdriver to remove the handset hook.**
- 2 Turn the hook upside down and insert.**

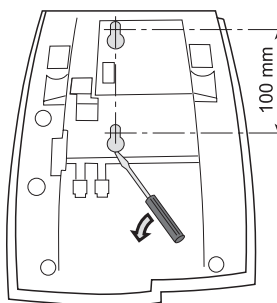

- 3 Use a screwdriver to remove the two plastic covers.**
- 4 Drill wall holes according to measure.**

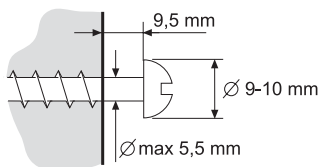

- 5 Mount screws according to measures and attach the phone.**

## Placing the phone

Do not expose your phone to direct sunlight for long periods. Keep the phone away from excessive heat and moisture.

---

## Cleaning

Clean your phone only with a soft, water dampened cloth. Using soap or any other cleaning materials may discolor or damage the phone.



# Troubleshooting

When something does not work properly, you can initiate a telephone selftest to check if your telephone set is in order, or if the fault is in the system. For the Dialog 4222 Office phone, you can also check the firmware revision state of your phone.

## To initiate a telephone selftest

*Dialog 4220 Lite:*

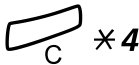

**Press and hold simultaneously until a ring signal is heard.**

All the key lamps on the phone should be switched on during the selftest to indicate that each key lamp is OK.

**#**

**Press to exit.**

*Note: If you do not press #, the selftest is automatically finished after about 30 seconds.*

*Dialog 4222 Office:*

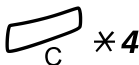

**Press and hold simultaneously until a ring signal is heard.**

The display shows the firmware revision state and **Selftest OK** for a few seconds. If there is something wrong, a fault message appears. Inform your system administrator about the fault message.

All the key lamps on the phone (and connected extra key panel) should be switched on during the selftest to indicate that each key lamp is OK.

After a few seconds the display is checked (the display is completely dark). The display is OK when there are no light dot(s) or line(s). The light frame around the display is supposed to be there.

**#**

**Press to exit.**

*Note: If you do not press #, the selftest is automatically finished after about 30 seconds.*

# Glossary

<b><i>Additional lines</i></b>	One or more additional extension numbers can be assigned to your phone, these are programmed on free function keys.
<b><i>Exchange</i></b>	Switch. Your telephone switching system, e.g. MD110 Communication System
<b><i>Idle mode</i></b>	The state your phone is in when nothing is activated; not calling, not ringing, not diverted etc.
<b><i>Speed Dialing number</i></b>	Abbreviated number or short number, used for making frequently used numbers faster to dial.
<b><i>Supervision</i></b>	Your extension number can be represented on a function key on other extensions (two or more).
<b><i>Traffic state</i></b>	The different states your phone is in; calling, ringing, diverted, etc.
<b><i>Triple Access Line</i></b>	A collective name for Line 1, Line 2 and Inquiry lines. Line 1 and Line 2 forms your extension number and are available both for incoming and outgoing calls. Inquiry can only be used for outgoing calls.

# Index

## A

- Absence information 51
- Accessories 82
  - Extra handset 86
  - Headset 83
  - Key panel 82
  - Option unit 87
  - Pull-out leaf 86
- Account code 62
- Additional directory number 66
- Alarm extension 65
- Answer calls 16
- Authority 29
- Authorization code, common 30
- Authorization code, individual 31

## B

- Bypass 26

## C

- Call Forwarding 39
  - Diversion 39
  - External Follow-me 44
  - Internal Follow-me 42
  - Personal Number 45
- Call Waiting 25
- Callback 23
- Common bell group 59
- Common Speed Dialing numbers 27
- Conference 36
- Copyright 5

## D

- Data communication 66
- Data privacy 29

- Declaration of conformity 5

- Description 6

- Choice of language 14
- Display information 12
- Lamp indications 9
- Tones and signals 10

- Dial by a function key 28

- Dialing during a connected call 38

- DISA = Direct Inward System Access 68

- Display information 12

- Diversion 39

- Do not disturb, DND 18

- DTMF signals 38

- During calls 33

- Conference 36

- Dialing during a connected call 38

- Group listening (loudspeaking) 33

- Handsfree 34

- Handsfree to loudspeaking 33

- Inquiry 34

- Loudspeaking to handsfree 33

- Microphone on or off 34

- On hold 37

- Send caller's identity code 38

- Transfer 35

## E

- Emergency mode 65

- External Follow-me 44

- Extra handset 86

## F

- Free on 2nd 17

- Free Seating 15

- Functions and required data 71

## G

- General Deactivation 64
- Glossary 98
- Group Call-pick-up 59
- Group Do not disturb 61
- Group features 59
- Group Hunting 60
- Group listening (loudspeaking) 33

## H

- Handset and loudspeaker volume 75
- Handsfree 34
- Headset 83
- Hot line 65

## I

- Immediate Speech Connection 63
- Incoming calls 16
  - Answer a second call 17
  - Do not disturb, DND 18
  - Handsfree 16
  - On another extension 17
  - On any other line key 16
  - On Line 1 16
- Individual external line 21
- Individual Speed Dialing numbers 27
- Inquiry 34
- Installation 88
- Integrated voice mail 56
- Internal Follow-me 42
- Internal messages 53
- Intrusion 25

## K

- Key panel 82

## L

- Lamp indications 9
- Language 14
- Last External Number Redial 21

## M

- Mailbox 58
- Make calls 19
- Malicious Call Tracing 67
- Manual Message Waiting (MMW) 53
- Melody ringing 77

- Message Waiting 55
- Messages 53
  - Integrated voice mail 56
  - Manual Message Waiting (MMW) 53
  - Message Waiting 55
- Multiple represented directory number 67
- Mute 34
- Mute ring signal 76

## N

- Night Service 64
- Number presentation restriction 20

## O

- On hold 37
- Option unit 87
- Other useful features 62
- Outgoing calls 19
  - Authority 29
  - Bypass 26
  - Call Waiting 25
  - Callback 23
  - External calls 19
  - Handsfree 20
  - Individual external line 21
  - Internal calls 19
  - Intrusion 25
  - Last External Number Redial 21
  - Number presentation restriction 20
  - Save external number 22
  - Speed Dialing 27
  - When you receive a busy tone 23

## P

- Personal Number 45
- Programming of functions 69
- Programming of ring signal tone character 74
- Programming of ring signals 73
- Pull-out leaf 86
- Put a call on hold 37

## R

- Redial number 22
- Refer back 35
- Ring signal volume 76
- Ring signals 11

**S**

- Save external number 22
- Send caller identity code at transfer 38
- Setting form for search profiles 50
- Settings 69
  - Functions and required data 71
  - Handset and loudspeaker volume 75
  - Melody ringing 77
  - Mute ring signal 76
  - Programming of functions 69
  - Programming of ring signal tone character 74
  - Programming of ring signals 73
  - Ring signal volume 76
  - Silent ringing 76
- Short numbers 27

- Silent ringing 76
- Speed Dialing 27

**T**

- Tones and signals 10
- Transfer 35
- Troubleshooting 97

**V**

- Volume 75

**W**

- Warranty 5
- Welcome 4
- When you receive a busy tone 23

Ericsson is shaping the future of Mobile and Broadband Internet communications through its continuous technology leadership. Providing innovative solutions in more than 140 countries, Ericsson is helping to create the most powerful communication companies in the world.

Ericsson Enterprise AB  
All rights reserved.  
For questions regarding the product,  
please contact your Ericsson Enterprise Certified Sales Partner.  
Also visit us on <http://www.ericsson.com/enterprise>

© Ericsson Enterprise AB 2004  
EN/LZT 103 60 R2A