



Cisco Unified IP Phone 6901 and 6911 User Guide for Cisco Unified Communications Manager 8.0 (SCCP)

Americas Headquarters

Cisco Systems, Inc.
170 West Tasman Drive
San Jose, CA 95134-1706
USA
<http://www.cisco.com>
Tel: 408 526-4000
800 553-NETS (6387)
Fax: 408 527-0883

Contents

Your Phone 1

Cisco Unified IP Phone 6901 1

Phone Connections 1

Buttons and Hardware 3

Footstand 5

Handset Rest 6

Hookswitch 6

Cisco Unified IP Phone 6911 7

Phone Connections 7

Buttons and Hardware 9

Paper Label 11

Footstand 11

Handset Rest 14

Messages 15

Voice Messages 15

Personalize Your Voicemail 15

Check for Voice Messages 15

Listen to Voice Messages 16

Calling Features 17

Auto Answer 17

Auto Answer with Your Speakerphone 17

Auto Barge 17

Call Forward All 17

Forward Calls on Your Phone 18

Call Pickup 18

Answer a Call Using Pickup 19

Answer a Call Using Group Pickup and a Group Pickup Number 19

Call Waiting	19
Respond to a Call Waiting Notification	19
Codes	20
Place a Call Using a Client Matter Code	20
Place a Call Using a Forced Authorization Code	20
Conference	20
Set up a Conference Using Hookflash	20
Drop a Party from a Conference Using Hookflash	21
Set Up a Conference	21
Hookflash	22
Use Hookflash to Activate Features	22
Hold	22
Hold and Resume a Call	22
Meet Me	22
Host a Meet Me Conference	23
Join a Meet Me Conference	23
Mute	23
Mute Your Phone	23
Redial	23
Redial a Number	23
Shared Lines	24
Speed Dial	24
Place a Call with a Speed-Dial Button	25
Transfer	25
Transfer a Call to Another Number Using the Hookflash	25
Transfer a Call to Another Number Using the Transfer Button	25
Swap Between Calls Before Completing a Transfer	26
Web Dialer	26
Use Web Dialer with Cisco Directory	26
Set Up, View, or Change Web Dialer Preferences	26
Sign Out of Web Dialer	27
User Options	29
User Options Web Pages	29

Sign In and Out of User Options Web Pages	29
Device	30
Select a Device From the User Options Web Pages	30
Line Settings	30
Speed Dial on the Web	31
User Settings	32
Change Your Browser Password	32
Change Your PIN	32
Change the Language for Your User Options Web Pages	33
Plugins	33
Access Plugins	33
FAQs and Troubleshooting	35
Frequently Asked Questions	35
Troubleshooting Tips	35
Conference	35
User Options	36
Product Safety, Security, Accessibility, and Additional Information	37
Safety and Performance Information	37
Power Outage	37
Cisco Product Security	37
Accessibility Features	37
Additional Information	38
Cisco One-Year Warranty	39
Cisco One-Year Limited Hardware Warranty Terms	39
Index	41

Your Phone

Cisco Unified IP Phone 6901

The Cisco Unified IP Phone 6901 provides these features:

- Phone connections
- Buttons and hardware
- Footstand
- Handset rest

Phone Connections



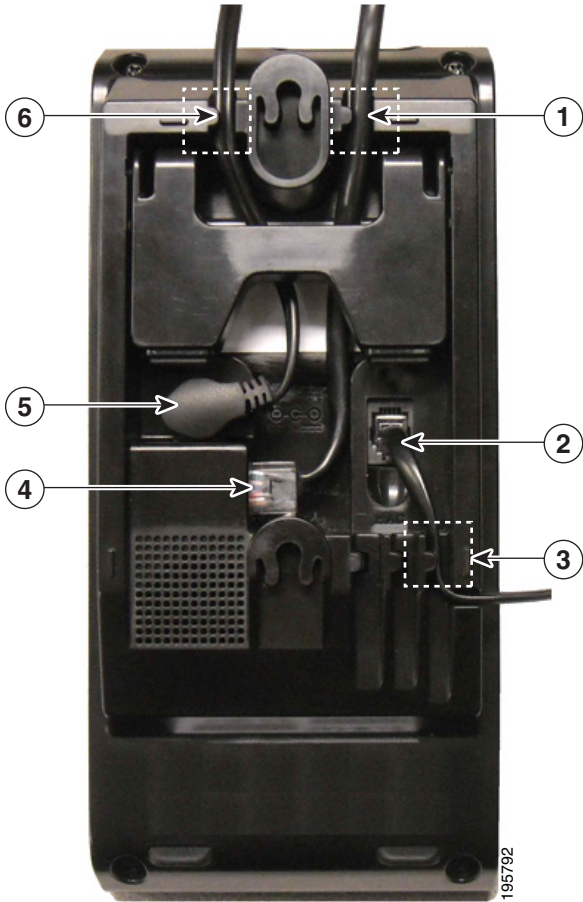

For your phone to work, it must be connected to the corporate IP telephony network. Your system administrator can help you connect your phone.



1	Slot for Ethernet cable.	4	Network port (10/100 SW) connection. IEEE 802.3af power enabled.
2	Handset connection.	5	DC adaptor port (DC48V).
3	Slot for handset cable.	6	Slot for DC adaptor cable.

Buttons and Hardware



1	Hookswitch	Activates the features (hookflash) on your phone.
2	Hold button 	Places a connected call on hold.
3	Redial button 	Dials the last dialed number.
4	Line button 	<p>Allows you to pick up a second incoming call. The Line button LED indicates the call status.</p> <p>Allows you to answer a ringing call and swap between two calls on the same line. Also, you can use the line button to create a new call when the phone is idle. The LED associated with the line button lights up to reflect the line status.</p> <p>Color LEDs indicate the line state:</p> <ul style="list-style-type: none"> • Green, steady—Active call • Green, flashing—Held call • Amber, Flashing—Incoming call • Amber, steady—Call forward all activated • Red, steady—Remote line in use (shared line) • Red, flashing—Remote line on hold
5	Volume button 	Controls the handset and the ringer volume (on hook).
6	Keypad	Allows you to dial phone numbers.
7	Handset with light strip	Lights up to indicate a ringing call (flashing red) or a new voice message (steady red).

Footstand

The Cisco Unified IP Phone 6901 has a foldable footstand. When the footstand is unfolded, it gives the phone an elevated viewing angle.



Handset Rest

Your system administrator may have mounted your phone on a wall. With a wall-mounted phone, you might need to adjust the handset rest to ensure that the receiver will not slip out of the cradle.

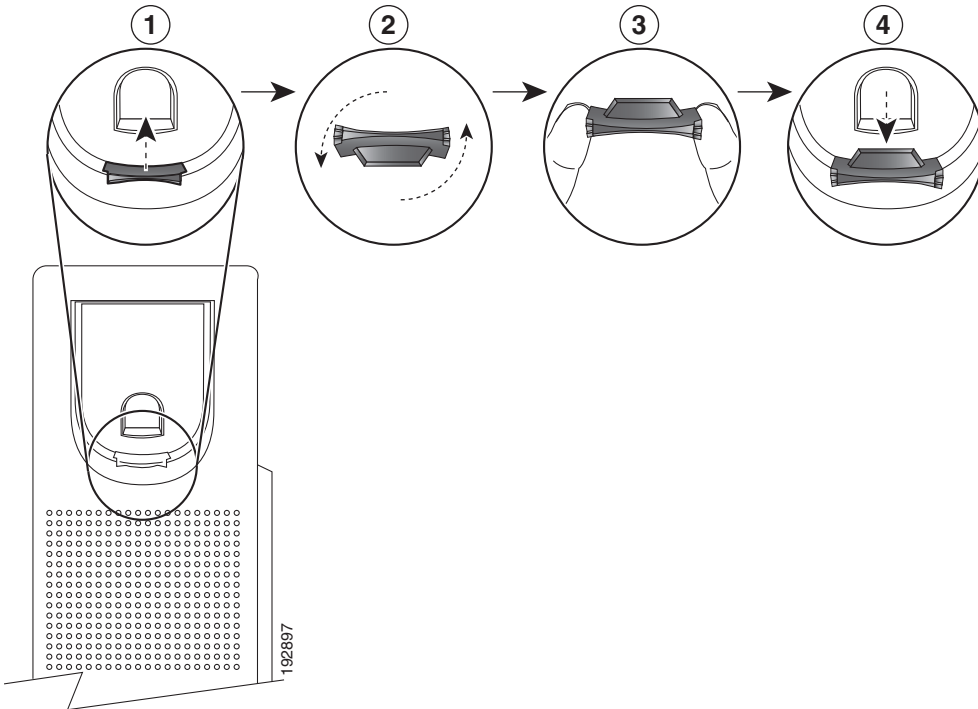

1	Remove the handset from the cradle and pull the plastic tab from the handset rest.
2	Rotate the tab 180 degrees.
3	Hold the tab between two fingers, with the corner notches facing you. Make sure the tab lines up evenly with the slot in the handset cradle.
4	Press the tab evenly into the slot. An extension protrudes from the top of the rotated tab. Return the handset to the handset rest.

Hookswitch

The hookswitch button is located on the cradle rest of your phone. You can press and quickly release the hookswitch button to activate features (hookflash) on your phone. Your administrator can set up the hookswitch timer.

Cisco Unified IP Phone 6911

The Cisco Unified IP Phone 6911 provides these features:

- Phone connections
- Buttons and hardware
- Phone template
- Footstand
- Handset rest

Phone Connections

For your phone to work, it must be connected to the corporate IP telephony network. Your system administrator can help you connect your phone.

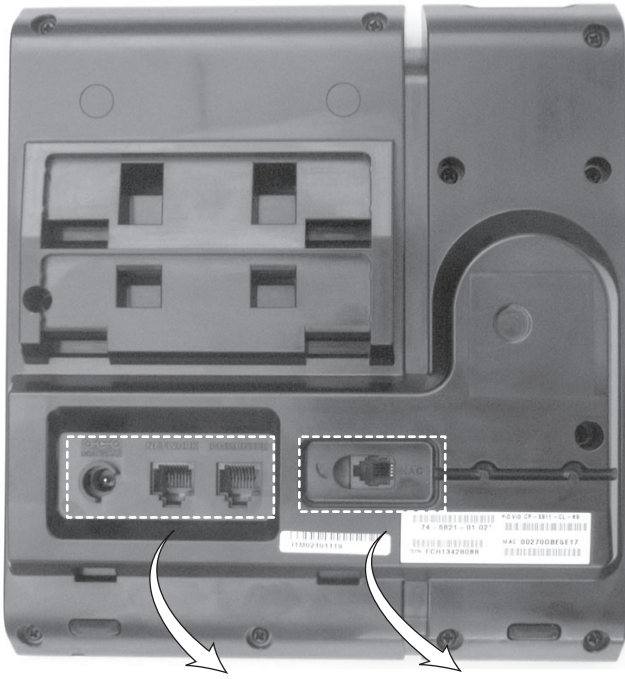

195780

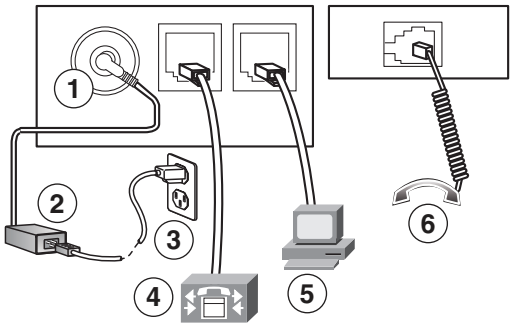











1	DC adaptor port (DC48V).	4	Network port (10/100 SW) connection. IEEE 802.3af power enabled.
2	AC-to-DC power supply (optional).	5	Access port (10/100 PC) connection.
3	AC power wall plug (optional).	6	Handset connection.

Buttons and Hardware



195778

1	Handset with light strip	Lights up to indicate a ringing call (flashing red) or a new voice message (steady red).
2	Paper label	A paper strip used to enter name and contact numbers.
3	Transfer button 	Transfers a call.
4	Conference button 	Creates a conference call.
5	Hold button 	Places an active call on hold.

6	Line button 	Allows users to pick up a second incoming call and to resume a held call. The LED shows call status.
7	Speakerphone button 	Selects the speakerphone as the default audio path and initiates a new call, picks up an incoming call, or ends a call. During a call, the button is lit green. The speakerphone audio path does not change until a new default audio path is selected (for example, by picking up the handset).
8	Keypad	Allows you to dial phone numbers.
9	Mute button 	Toggles the microphone on or off. When the microphone is muted, the button is lit red.
10	Volume button 	Controls the handset and speakerphone volume (off hook) and the ringer volume (on hook).
11	Messages button 	Auto-dials your voice messaging system (varies by system).
12	Redial button 	Dials the last dialed number.
13	Feature button 	<p>Depending on how your system administrator sets up the phone, the feature button provides you access to Speed dialing, Call Forward All, Pickup, Group Pickup and Meet Me features. Users can configure up to nine items on the feature button. You can access each of these features by pressing the feature button followed by the number associated with the feature. You must press the number within five seconds of pressing the feature button. The number can only be a single digit number from 1–9.</p> <p>You can access these features either off hook or on hook:</p> <ul style="list-style-type: none"> • Call Forward All—Allows you to forward a call. • Pickup—Allows you to pickup a call on the third party phone. • Group Pickup—Allows you pick up a call within a group. • Meet Me—Allows you setup a conference.
14	Handset	Phone handset.

Paper Label

Cisco Unified IP Phone 6911 does not include an LCD display. A paper strip is provided and can be used to enter name and contact numbers.

Footstand

If the phone is placed on a table or desk, the footstand can be connected to the back of your phone for a higher or lower viewing angle, depending on your preference.

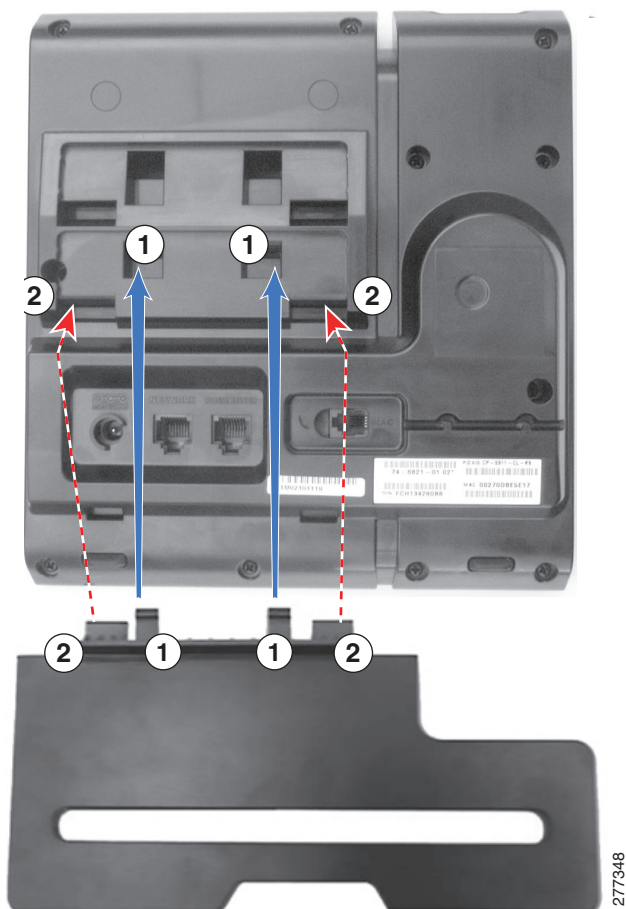

1 Insert the connectors into the lower slots.	2 Lift the footstand until the connectors snap into the upper slots.
--	---

Higher Viewing Angle

Connect the footstand to the lower slots for a higher viewing angle.



Lower Viewing Angle

Connect the footstand to the upper slots for a higher viewing angle.



Handset Rest

Your system administrator may have mounted your phone on a wall. With a wall-mounted phone, you might need to adjust the handset rest to ensure that the receiver does not slip out of the cradle.

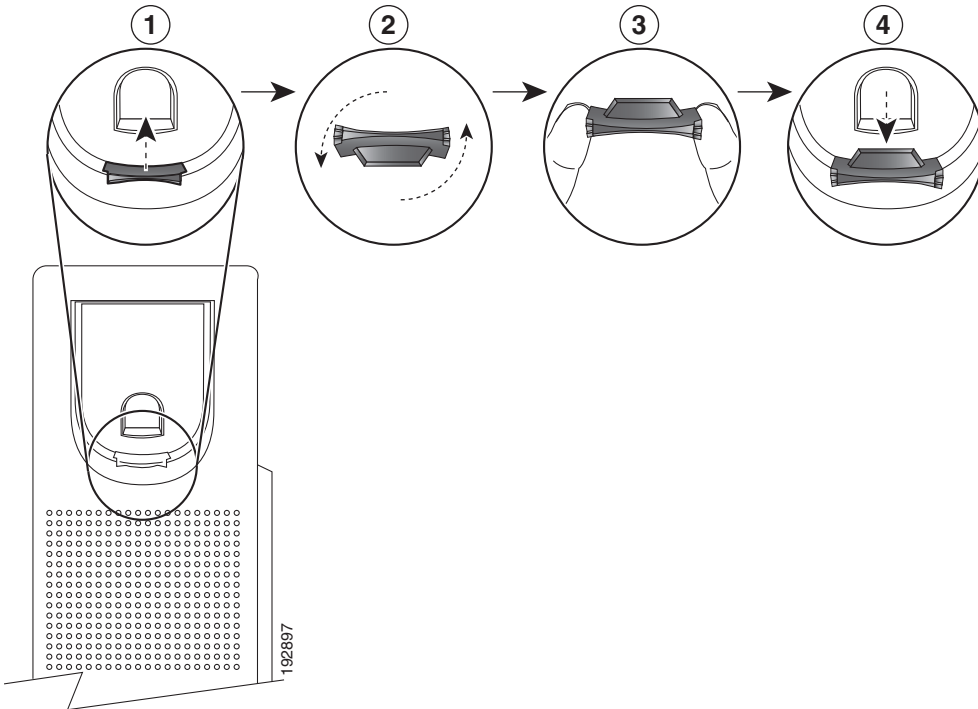

1	Remove the handset from the cradle and pull the plastic tab from the handset rest.
2	Rotate the tab 180 degrees.
3	Hold the tab between two fingers, with the corner notches facing you. Make sure the tab lines up evenly with the slot in the handset cradle.
4	Press the tab evenly into the slot. An extension protrudes from the top of the rotated tab. Return the handset to the handset rest.

Messages

Voice Messages

Voice messages are stored on your voicemail system. Your company determines the voicemail system your phone uses.

You can:

- Personalize your voicemail
- Check for voice messages
- Listen to voice messages

Personalize Your Voicemail

(Cisco Unified IP Phone 6911 only.)

Press the **Messages** button , then follow the voice prompts.

(Cisco Unified IP Phone 6901 only.)

Using the keypad, dial the voicemail access number (provided by your system administrator), then follow the voice prompts.

Check for Voice Messages

Check for voice messages in any of these ways:

- Look for a solid red light on your handset.
You can configure the visual message waiting lamp using your User Options web pages.
- Listen for a stutter tone when you lift the handset.
You can configure the audible message waiting lamp using your User Options web pages.

Related Topics

[User Options Web Pages, page 29](#)

Listen to Voice Messages

(Cisco Unified IP Phone 6911 only.)

Press the **Messages** button  and then follow the voice prompts to listen to your messages.

(Cisco Unified IP Phone 6901 only.)

Using the keypad, dial the voicemail access number (provided by your system administrator) and then follow the voice prompts to listen to your messages.

Calling Features

Auto Answer

(Cisco Unified IP Phone 6911 only)

Auto Answer prompts your phone to automatically answer incoming calls after one ring. Your system administrator sets up Auto Answer to work with your speakerphone.

Auto Answer with Your Speakerphone

Keep the handset in the cradle to auto answer with your speakerphone. Otherwise, calls ring normally and you must manually answer them.

Auto Barge

Auto barge, if configured, allows you to barge into a shared line call automatically.

For example, in a shared line scenario, when you go off hook and a call remote is already in use, you can barge into the call automatically.

Call Forward All

Call Forward All allows you to forward calls on your phone to another number.

You can set up Call Forward All directly on your phone. To access Call Forward All remotely, go to your User Options web pages.

There are two types of call-forwarding features that your system administrator may set up on your phone:

- Unconditional call forwarding (Call Forward All)—Applies to all calls that you receive.
- Conditional call forwarding (Call Forward No Answer, Call Forward Busy, Call Forward No Coverage)—Applies to certain calls that you receive, according to conditions, and is accessible only from your User Options web pages.

When forwarding calls from your phone, enter the call-forward target phone number exactly as you would dial it from your phone. For example, enter an access code or the area code, if necessary.

Your system administrator can set up other call forward options that:

- Allow calls placed from the call forward target phone number to your phone to ring through, rather than be forwarded.
- Prevent you from creating a call forward loop or exceeding the maximum number of links in a call forwarding chain.

Related Topics

[Set Up Call Forwarding Per Line, page 30](#)

Forward Calls on Your Phone

(Cisco Unified IP Phone 6901 only)

1. Sign in to your User Options web pages.
2. Go to **Device > Line Settings**.
3. Enter the phone number you want to forward calls to.
4. Click **Save**.

(Cisco Unified IP Phone 6911 only)

1. Press the **Feature** button  followed by the predetermined number set up for Call Forward All.
2. Listen for a dial tone, then enter the phone number to which your calls will be forwarded.
A visual confirmation is displayed as a solid amber light on the handset.
3. To cancel call forwarding, repeat Step 1.

When you lift the handset, you will hear a stutter tone until you cancel call forwarding. The visual confirmation turns off when Call Forward All is canceled.

Call Pickup

(Cisco Unified IP Phone 6911 only)

Call Pickup allows you to answer a call that is ringing on a coworker's phone by redirecting the call to your phone.

You may use Call Pickup if you share call-handling tasks with coworkers.

There are three ways you can pick up a call:

- **Pickup**—Allows you to answer a call that is ringing on another phone within your call pickup group.

If multiple calls are available for pickup, your phone picks up the oldest call first (the call that has been ringing for the longest time).

- Group Pickup—Allows you to answer a call on a phone that is outside your call pickup group by:
 - Using a group pickup number (provided by your system administrator).
 - Dialing the ringing phone’s number if the destination user’s direct number is present in one of the current user’s associated groups.

Your system administrator sets up the call pickup group you are in and the call pickup buttons depending on your call-handling needs and work environment.

Answer a Call Using Pickup

(Cisco Unified IP Phone 6911 only)

1. If Auto Pickup is set up on your phone, press the **Feature** button  followed by the predetermined number set up for Call Pickup to transfer a ringing call within your pickup group to your phone. The call is connected.
2. If Auto Pickup is not set up, press the **Line** button or lift the handset to connect the call.

Answer a Call Using Group Pickup and a Group Pickup Number

(Cisco Unified IP Phone 6911 only)

1. If Auto Group Pickup is set up on your phone, press the **Feature** button  followed by the predetermined number set up for Call Pickup to answer a call on a phone outside your pickup group.
2. Enter the group pickup number to connect the call.
3. If Auto Group Pickup is not set up, press the **Line** button or lift the handset to connect the call.

Call Waiting

Call Waiting provides cues to notify you that a new call is ringing on your phone when you are talking on another call, including:

- A call waiting tone (single beep)
- An amber flashing **Line** button 

Respond to a Call Waiting Notification

To answer the ringing call, press the flashing amber **Line** button. Your phone puts the original call on hold automatically and connects the ringing call.

Codes

Codes allow you to place a call using a billing or tracking code. Your phone supports two types of codes (provided by your administrator):

- Client Matter Codes (CMC) require you to enter a code to specify that the call relates to a specific client matter. Your administrator can assign client matter codes to customers, students, or other populations for call accounting and billing purposes.
- Forced Authorization Codes (FAC) allow you to manage call access and accounting. The Forced Authorization Codes feature requires that the user enter a valid authorization code before the call connects.

Place a Call Using a Client Matter Code

1. Dial a number.
2. After the tone, enter a client matter code (CMC).

Place a Call Using a Forced Authorization Code

1. Dial a number.
2. After the tone, enter a forced authorization code (FAC).

Conference

Conference allows you to talk simultaneously with multiple parties. When you are talking on a call, use Conference to dial another party and add them to the call. You can remove individual participants from the conference if your phone supports the feature.

You can set up a conference by using

- the hookflash feature on the Cisco Unified IP Phone 6901.
- the **Conference** button  on the Cisco Unified IP Phone 6911.

The conference ends when all the participants hang up.

Set up a Conference Using Hookflash

(Cisco Unified IP Phone 6901 only.)

1. Verify that you are on an active call (not on hold).
2. Press and release the hookswitch to get a dial tone.
3. Dial the party's number.

4. Wait for the recipient to answer. (Or, skip to Step 5. while the call is ringing).
5. Press and release the hookswitch again.

The conference begins.

**Note**

You can only include three participants in a conference. Use the hookflash feature to drop a participant from a conference.

Drop a Party from a Conference Using Hookflash

(Cisco Unified IP Phone 6901 only.)

1. Verify that you are in a conference.
2. Press and release the hookswitch.

The party who joined last is dropped from the conference.

**Note**

Only the conference host can drop a party from a conference.

Set Up a Conference

(Cisco Unified IP Phone 6911 only.)

1. Verify that you are on an active call (not on hold).
2. Press the **Conference** button .
3. Enter the phone number for the party you want to add to the conference.
4. Wait for the party to answer (or skip to Step 5. while the call is ringing).
5. Press the **Conference** button again.

The conference begins.

Repeat these steps to add more parties, if desired.

Hookflash

Hookflash allows you to activate features on your phone by quickly pressing and releasing the hookswitch button on the phone cradle rest.

Use Hookflash to Activate Features

(Cisco Unified IP Phone 6901 only)

You can use hookflash to:

- Answer a call
- Transfer between two calls (when one call is incoming only)
- Initiate a conference call
- Remove a conference participant

Hold

Hold allows you to put an active call into a held state.

Hold and Resume a Call

1. To put a call on hold, press the **Hold** button .
The **Line** button flashes green. The party that is put on hold hears the preset music.
2. To resume the call, press the flashing green **Line** button, press the **Speaker** button (Cisco Unified IP Phone 6911 only), or go off hook, if the handset is in the cradle.

Meet Me

Meet Me allows you to call a predetermined number at a scheduled time to host or join a conference. The conference begins when the host connects. Participants who join the conference before the host has joined hear a busy tone and must dial again.

The conference ends when all participants hang up; the conference does not automatically end when the host disconnects.

Host a Meet Me Conference

(Cisco Unified IP Phone 6911 only)

1. Press the **Feature** button  followed by the predetermined Meet Me number (set up by your system administrator).

You are connected to the conference.

Join a Meet Me Conference

1. Go off-hook and dial the Meet Me conference number (provided by the conference host).
2. Enter the conference code provided by the Meet Me host.

You are connected to the conference.

Mute

(Cisco Unified IP Phone 6911 only)

Mute allows you to block audio input for your handset and speakerphone, so that you can hear other parties on the call but they cannot hear you.

Mute Your Phone

(Cisco Unified IP Phone 6911 only)

1. Press the **Mute** button  to turn Mute on.
2. Press the **Mute** button again to turn Mute off.

Redial

Redial allows you to call the most recently dialed phone number by pressing the **Redial** button.

Redial a Number

To redial a number:

- On Cisco Unified IP Phone 6901, go off-hook and press the **Redial** button.
- On Cisco Unified IP Phone 6911, press the **Redial** button . You can be off-hook or on-hook when you press this button.

Shared Lines

Shared lines allow you to use one phone number for multiple phones.

You may have a shared line if you have multiple phones and want one phone number, share call-handling tasks with co-workers, or handle calls on behalf of a manager.

For example, if you share a line with a coworker:

- When a call comes in on the shared line:
 - Your phone rings and the **Line** button  flashes amber.
 - Your coworker's phone rings and the **Line** button flashes amber.
- If you answer the call:
 - Your **Line** button turns green.
 - Your coworker's **Line** button turns red.

When button is red, that line cannot be used to barge in on the call or used to make another call. If barge is enabled, you can auto barge a call by going off hook. If it is disabled, you can make another call by going off hook.

- If you put the call on hold:
 - Your **Line** button flashes green
 - Your coworker's **Line** button flashes red.

When the **Line** button flashes red, your coworker can pick up the call.

Related Topics

[Answer a Call Using Pickup, page 19](#)

[Answer a Call Using Group Pickup and a Group Pickup Number, page 19](#)

Speed Dial

(Cisco Unified IP Phone 6911 only.)

Speed-dial features allow you to place a call by pressing a button or by entering a code. Before you can use speed-dial features on your phone, you must set up speed-dial on your User Options Web pages.

Depending on setup, your phone can support this speed-dial feature:

- **Feature Button**—Allows you to quickly dial a phone number if the this button is set up for speed dialing.

Place a Call with a Speed-Dial Button

(Cisco Unified IP Phone 6911 only.)

(Before you can use speed-dial buttons on your phone, you must set up speed dial on your User Options Web pages.)

To place a call, press the Feature button enabled for speed dial.

Transfer

Transfer allows you to redirect a connected call from your phone to another number.

- You can redirect a single call to another number that you specify. Transfer is accomplished differently depending on the phone model you have:
 - Hookflash is used to transfer calls from the Cisco Unified IP Phone 6901.
 - The Transfer button  is used to transfer calls from the Cisco Unified IP Phone 6911.
- For Cisco Unified IP Phone 6911 only, you can connect two calls to each other (without remaining on the line yourself).

Transfer a Call to Another Number Using the Hookflash

(Cisco Unified IP Phone 6901 only.)

1. Verify that you are on an active call (not on hold).
2. Press and release the hookswitch to get a dial tone.
3. Enter the transfer recipient's phone number.
4. Wait for the recipient to answer. (Or, skip to Step 5. while the call is ringing.)
5. Hang up to complete the transfer.

Transfer a Call to Another Number Using the Transfer Button

(Cisco Unified IP Phone 6911 only.)

1. Verify that you are on an active call (not on hold).
2. Press the **Transfer** button .
3. Enter the transfer recipient's phone number (or press a speed dial button).
4. Wait for the recipient to answer. (Or, skip to Step 5. while the call is ringing.)
5. Press the **Transfer** button again or hang up to complete the transfer.

Swap Between Calls Before Completing a Transfer

(Cisco Unified IP Phone 6911 only.)

After you connect to the transfer recipient—but before you transfer a call to this party—you can press the **Line** button to toggle between the two calls. This allows you to consult privately with the party on each call before you complete the transfer.

Web Dialer

(Cisco Unified IP Phone 6911 only.)

Web Dialer allows you to click-to-dial contacts from the Cisco Unified CM Directory. Your system administrator sets up this feature for you.

Use Web Dialer with Cisco Directory

(Cisco Unified IP Phone 6911 only.)

1. Sign in to your User Options web pages.
2. Select **User Options > Directory** and search for a co-worker.
3. Select the number that you want to dial.
4. If this is your first time using Web Dialer, review the preferences on the Make Call page.
5. Select **Dial**.

The call is now placed on your phone.

6. To end a call, select **Hang up** or hang up from your phone.

Set Up, View, or Change Web Dialer Preferences

(Cisco Unified IP Phone 6911 only.)

1. Initiate a call using Web Dialer to access the Make Call page.

The Make Call page displays the first time that you use WebDialer (after you select the number that you want to dial).

2. Select one of the following options from the Make Call page:
 - Preferred language—Determines the language used for Web Dialer settings and prompts.
 - Use preferred device—Identifies the Cisco Unified IP Phone (Calling device) and directory number (Calling line) that you will use to place Web Dialer calls. If you have one phone with a single line, the appropriate phone and line are automatically selected. Otherwise, choose a phone and/or line. If you have more than one phone of the same type, it will be specified by device type and MAC address.

- Do not display call confirmation—If selected, the Web Dialer Make Call page will not display the next time Web Dialer is used. Calls will automatically be dialed after clicking on a contact from the Cisco Directory.
- Disable Auto Close—If selected, the call window does not close automatically after fifteen seconds.

Sign Out of Web Dialer

(Cisco Unified IP Phone 6911 only.)

Select the Sign Out icon  in the Make Call or Hang Up page.

User Options

User Options Web Pages

Your Cisco Unified IP Phone is a network device that can share information with other network devices in your company, including your personal computer.

You can use your computer to sign in to your Cisco Unified CM User Options web pages, where you can control features, settings, and services for your Cisco Unified IP Phone. For example, you can set up speed-dial buttons from your User Options web pages.

After you have signed in to your User Options web pages, select User Options to access the following:

- Device
- User Settings
- Plugins

Sign In and Out of User Options Web Pages

Before you can access any of your user options, such as speed-dial settings or personal address book, you must sign in. When you are finished using the user options web pages, you must sign out.

1. Obtain the User Options URL, user ID, and default password (provided by your system administrator).
2. Open a web browser on your computer and enter the URL.
3. If prompted to accept security settings, select **Yes** or **Install Certificate**.
4. Enter your user ID in the Username field.
5. Enter your password in the Password field.
6. Select **Login**.

The Cisco Unified CM User Options home page displays. From this page you can select User Options to select a device, access User Settings, Directory features, your Personal Address Book, and Fast Dials.

7. To sign out of user options, select **Logout**.

Device

You can make changes to your device settings on your phone from the User Options web pages. You can make changes to these device settings on your phone:

- Line settings
- Speed dials

Select a Device From the User Options Web Pages

1. After you have signed in to your User Options web pages, select **User Options > Device**. The Device Configuration page displays. Toolbar buttons located at the top of the Device Configuration page are specific to the selected device type.
2. If you have multiple devices assigned to you, select the appropriate device (phone model, Extension Mobility profile, or Remote Destination profile) from the Name drop-down menu.

Line Settings

Line settings affect a specific phone line (directory number) on your phone. Line settings can include call forwarding, message-waiting indicators, voice-message indicators, ring patterns, and other line-specific settings.

You can set up other line settings directly on your phone:

- Set up call forwarding for your primary phone line
- Change rings and other phone-model specific settings

Related Topics

[Call Forward All, page 17](#)

Set Up Call Forwarding Per Line

1. Sign in to your User Options web page.
2. Select **User Options > Device**.
3. Select a phone from the Name drop-down menu.
4. Select **Line Settings**.
5. If you have more than one directory number (line) assigned to your phone, select a line from the Line drop-down menu.
6. In the Incoming Call Forwarding area, select call forwarding settings for various conditions.
7. Select **Save**.

Related Topics

[Call Forward All, page 17](#)

Change the Voice Message Indicator Setting Per Line

1. Sign in to your User Options web page.
2. Select **User Options > Device**.
3. Select a phone from the Name drop-down menu.
4. Select **Line Settings**.
5. If you have more than one directory number (line) assigned to your phone, select a line from the Line drop-down menu.
6. In the Message Waiting Lamp area, choose from various settings. Typically, the default message waiting setting prompts your phone to display a steady red light from the handset light strip to indicate a new voice message.
7. Select **Save**.

Change the Audible Voice Message Indicator Setting Per Line

1. Sign in to your User Options web page.
2. Select **User Options > Device**.
3. Select a phone from the Name drop-down menu.
4. Select **Line Settings**.
5. If you have more than one directory number (line) assigned to your phone, select a line from the Line drop-down menu.
6. In the Audible Message Waiting Lamp area, choose from various settings.
7. Select **Save**.

Speed Dial on the Web

(Cisco Unified IP Phone 6911 only)

Depending on how your phone has been set up, you can use speed-dial buttons and speed-dial codes, which you can set up on your User Options Web pages.

Set Up Speed-Dial Buttons

(Cisco Unified IP Phone 6911 only)

1. Sign in to your User Options Web pages.
2. Select **User Options > Device**.

3. Select a phone from the Name drop-down menu.
4. Select **Speed Dials**.
5. In the Speed Dial Settings area, enter a number and label for a speed-dial button on your phone.
6. Select **Save**.

User Settings

Your PIN and password allow you to access different features and services. Use your password to sign in to your User Options web pages and Cisco Web Dialer on your personal computer. For more information, see your system administrator.

User settings include your browser password, PIN, and language (locale) settings.

Change Your Browser Password

1. Sign in to your User Options web pages.
2. Select **User Options > User Settings**.
3. Enter your Current Password.
4. Enter your New Password.
5. Reenter your new password in the Confirm Password field.
6. Select **Save**.

Change Your PIN

1. Sign in to your User Options web pages.
2. Select **User Options > User Settings**.
3. Enter your Current PIN.
4. Enter your New PIN.
5. Reenter your new PIN in the Confirm PIN field.
6. Select **Save**.

Change the Language for Your User Options Web Pages

1. Sign in to your User Options web page.
2. Select **User Options > User Settings**.
3. In the User Locale area, select an item from the Locale drop-down list.
4. Select **Save**.

Plugins

Plugins on your User Options web pages allow you to download and access applications that your system administrator sets up for you.

For more information, see your system administrator.

Access Plugins

1. Sign in to your User Options web page.
2. Select **User Options > Plugins**.

You can view plugins only if your system administrator has set them up for you.

FAQs and Troubleshooting

Frequently Asked Questions

Q. When I put a call on hold by pushing the Hold button, why doesn't pushing the button again resume the call?

A. The Hold button is only used to put a call on hold. To resume a call, press the Line button.

Q. How do I access a feature using the Feature button?

A. You need to press the feature button followed by the number set up for the feature you are trying to access. The number must be pressed within five seconds of pressing the feature button.

Troubleshooting Tips

Troubleshooting tips are available for these topics:

- Conference
- User Options

Conference

Problem: Conference Button

You have set up a conference call and the Conference button is unresponsive.

Possible Cause

You have reached the maximum number of conference participants.

Solution

Ask one of the participants to drop, or drop a conference participant.

Problem: Meet Me Conference Busy Tone

You hear a busy tone after dialing into a Meet Me conference.

Possible Cause

The conference host has not yet joined the conference.

Solution

Try calling back again.

User Options

Problem: Cannot Access User Options Web Pages

You are unable to access your user options web pages.

Possible Cause

Your password needs to be reset.

Solution

See your system administrator.

Product Safety, Security, Accessibility, and Additional Information

Safety and Performance Information

Power outages and other devices can affect your Cisco Unified IP Phone.

Power Outage

Your accessibility to emergency service through the phone is dependent on the phone being powered. If there is an interruption in the power supply, Service and Emergency Calling Service dialing will not function until power is restored. In the case of a power failure or disruption, you may need to reset or reconfigure equipment before using the Service or Emergency Calling Service dialing.

Cisco Product Security

This product contains cryptographic features and is subject to United States and local country laws governing import, export, transfer and use. Delivery of Cisco cryptographic products does not imply third-party authority to import, export, distribute or use encryption. Importers, exporters, distributors and users are responsible for compliance with U.S. and local country laws. By using this product you agree to comply with applicable laws and regulations. If you are unable to comply with U.S. and local laws, return this product immediately.

Further information regarding U.S. export regulations may be found at:

http://www.access.gpo.gov/bis/ear/ear_data.html.

Accessibility Features

The Cisco Unified IP Phones 6901 and 6911 provide accessibility features for the vision impaired, the blind, and the hearing and mobility impaired.

http://www.cisco.com/en/US/docs/voice_ip_comm/cuipph/all_models/accessibility/english/user/guide/access_6901-11.html

You can also find more information about accessibility at this Cisco website:

<http://www.cisco.com/web/about/responsibility/accessibility/index.html>

Additional Information

- You can access the Cisco website at this URL:
<http://www.cisco.com/>
- Cisco Unified IP Phone 6901 and 6911 quick reference card, quick start guides, and end-user guide:
http://www.cisco.com/en/US/products/ps10326/products_user_guide_list.html
- Licensing information:
http://www.cisco.com/en/US/products/ps10326/products_licensing_information_listing.html
- Cisco international websites:

Allows access to international Cisco websites from www.cisco.com by clicking the **Worldwide** [\[change\]](#) link at the top of the web page.

Cisco One-Year Warranty

Cisco One-Year Limited Hardware Warranty Terms

There are special terms applicable to your hardware warranty and various services that you can use during the warranty period.

Your formal Warranty Statement, including the warranties and license agreements applicable to Cisco software, is available on Cisco.com at the following URL:

http://www.cisco.com/en/US/docs/general/warranty/English/1Y1DEN__.html

Index

A

- AAP. *See* accessibility features
- access
 - plugins [33](#)
- audible alert. *See* alerts, audible
- audible message indicator. *See* message indicators
- Auto Answer, description [17](#)
- Auto Barge, description [17](#)

B

- browser password, change [32](#)
- buttons
 - Cisco Unified IP Phone 6901 [3](#)
 - Hold [4](#)
 - line [4](#)
 - Volume [4](#)
 - Cisco Unified IP Phone 6911 [9](#)
 - Conference [9](#)
 - Hold [9](#)
 - line [10](#)
 - Messages [10](#)
 - Mute [10](#)
 - programmable feature [10](#)
 - Speakerphone [10](#)
 - Transfer [9](#)

Volume [10](#)

C

- Call Forward All
 - description [17](#)
 - set up
 - on all lines [30](#)
 - setup
 - on primary line [18](#)
- Call Pickup, description [18](#)
- Call Waiting, description [19](#)
- calling features
 - Auto Answer [17](#)
 - Auto Barge [17](#)
 - Call Forward All [17](#)
 - Call Pickup [18](#)
 - Call Waiting [19](#)
 - Codes [20](#)
 - Conference [20](#)
 - hold [22](#)
 - Meet Me [22](#)
 - Mute [23](#)
 - Redial [23](#)
 - Shared Lines [24](#)
 - Speed Dial [24](#)
 - Transfer [25](#)

- Web Dialer [26](#)
- change
 - browser password [32](#)
 - language
 - user options web pages [33](#)
 - locale
 - user options web pages [33](#)
- check voice messages [15](#)
- Cisco Unified CM User Options. *See* user options
- Cisco Unified IP Phone 6901
 - buttons and hardware [3](#)
 - connections [1](#)
 - footstand [5](#)
 - handset rest [6](#)
 - hookswitch [4, 6](#)
- Cisco Unified IP Phone 6911
 - buttons and hardware [9](#)
 - connections [7](#)
 - footstand [11](#)
 - handset rest [14](#)
- Client Matter Codes (CMCs), description [20](#)
- conference
 - button
 - Cisco Unified IP Phone 6911 [9](#)
 - description [20](#)
 - drop a party using hookflash [21](#)
 - set up using hookflash [20](#)
- connections
 - Cisco Unified IP Phone 6901 [1](#)
 - Cisco Unified IP Phone 6911 [7](#)
- connectors. *See* connections
- customize voicemail [15](#)

D

- documentation, related [37](#)

F

- FAQs [35](#)
- flashing. *See* alerts, visual
- footstand
 - Cisco Unified IP Phone 6901 [5](#)
 - Cisco Unified IP Phone 6911 [11](#)
- Forced Authorization Codes (FACs), description [20](#)
- forward. *See* Call Forward All
- frequently asked questions. *See* FAQs

G

- Group Pickup, description [18](#)

H

- HAC. *See* accessibility features
- handset
 - Cisco Unified IP Phone 6901
 - light strip [4](#)
 - rest [6](#)
 - Cisco Unified IP Phone 6911
 - light strip [9](#)
 - location [10](#)
 - rest [14](#)
- hardware
 - Cisco Unified IP Phone 6901 [3](#)
 - Cisco Unified IP Phone 6911 [9](#)

Hold
 button
 Cisco Unified IP Phone 6901 [4](#)
 Cisco Unified IP Phone 6911 [9](#)
hold
 description [22](#)
hookflash
 description [22](#)
hookflash, using to set up conference [20](#)
hookswitch
 Cisco Unified IP Phone 6901 [4](#)

K

keypad
 Cisco Unified IP Phone 6901 [4](#)
 Cisco Unified IP Phone 6911 [10](#)

L

language
 change for user options web pages [33](#)
 Web Dialer settings [26](#)
LED. *See* lights
lights
 green
 flashing [4](#)
 steady [4](#)
 handset [4](#)
 red
 flashing [4](#)
 steady [4](#)
line

 buttons, Cisco Unified IP Phone 6901 [4](#)
 buttons, Cisco Unified IP Phone 6911 [10](#)
 settings [30](#)
 Call Forward [30](#)
 voice message indicator [31](#)
listen to voice messages [16](#)
locale
 change for user options web pages [33](#)
log in and out. *See* sign in and out

M

MAC address
 Web Dialer [26](#)
Meet Me, description [22](#)
message indicators [15](#)
 audible, change [31](#)
 voice, change [31](#)
messages
 button
 Cisco Unified IP Phone 6911 [10](#)
 check for [15](#)
 listen to [16](#)
 personalize voicemail [15](#)
Mute
 description [23](#)
mute
 button
 Cisco Unified IP Phone 6911 [10](#)
 turn on and off [23](#)

O

Other Pickup, description [18](#)

P

password. *See* browser password

personalize voicemail [15](#)

plugins [33](#)

power outage [37](#)

product security [37](#)

programmable feature buttons

 Cisco Unified IP Phone 6911 [10](#)

R

Redial

 description [23](#)

 redial a number [23](#)

 related documentation [37](#)

S

safety and performance

 power outage [37](#)

 security, product [37](#)

 set up

 speed-dial buttons [31](#)

 shared lines

 description [24](#)

 sign in and out

 user options [29](#)

 Web Dialer [26](#)

 Speakerphone

 Auto Answer with [17](#)

 button

 Cisco Unified IP Phone 6911 [10](#)

 Speed Dial

 buttons [31](#)

 set up [31](#)

 description [24](#)

T

Transfer

 button

 Cisco Unified IP Phone 6911 [9](#)

 Transfer, description [25](#)

 troubleshooting tips [35](#)

 TTY. *See* accessibility features

 turn on and off

 mute [23](#)

U

user options

 device

 speed dial [31](#)

 device, line settings [30](#)

 plugins [33](#)

 sign in and out [29](#)

 user settings

 change browser password [32](#)

 change user options web pages language [33](#)

V

visual alert. *See* alerts, visual

voice messages. *See* messages

voicemail. *See* messages

Volume

Cisco Unified IP Phone 6901 [4](#)

Cisco Unified IP Phone 6911 [10](#)

W

Web Dialer

MAC address [26](#)

sign in [26](#)

Web Dialer, description [26](#)



Americas Headquarters
Cisco Systems, Inc.
San Jose, CA

Asia Pacific Headquarters
Cisco Systems (USA) Pte. Ltd.
Singapore

Europe Headquarters
Cisco Systems International BV
Amsterdam, The Netherlands

Cisco has more than 200 offices worldwide. Addresses, phone numbers, and fax numbers are listed on the
Cisco Website at www.cisco.com/go/offices.

CCDE, CCENT, CCSI, Cisco Eos, Cisco Explorer, Cisco HealthPresence, Cisco IronPort, the Cisco logo, Cisco Nurse Connect, Cisco Pulse, Cisco SensorBase, Cisco StackPower, Cisco StadiumVision, Cisco TelePresence, Cisco TrustSec, Cisco Unified Computing System, Cisco WebEx, DCE, Flip Channels, Flip for Good, Flip Mino, Flipshare (Design), Flip Ultra, Flip Video, Flip Video (Design), Instant Broadband, and Welcome to the Human Network are trademarks; Changing the Way We Work, Live, Play, and Learn, Cisco Capital, Cisco Capital (Design), Cisco-Financed (Stylized), Cisco Store, Flip Gift Card, and One Million Acts of Green are service marks; and Access Registrar, Aironet, AllTouch, AsyncOS, Bringing the Meeting To You, Catalyst, CCDA, CCDP, CCIE, CCIP, CCNA, CCNP, CCSP, CCVP, Cisco, the Cisco Certified Internetwork Expert logo, Cisco IOS, Cisco Lumin, Cisco Nexus, Cisco Press, Cisco Systems, Cisco Systems Capital, the Cisco Systems logo, Cisco Unity, Collaboration Without Limitation, Continuum, EtherFast, EtherSwitch, Event Center, Explorer, Follow Me Browsing, GainMaker, iLNX, IOS, iPhone, IronPort, the IronPort logo, Laser Link, LightStream, Linksys, MeetingPlace, MeetingPlace Chime Sound, MGX, Networkers, Networking Academy, PCNow, PIX, PowerKEY, PowerPanels, PowerTV, PowerTV (Design), PowerVu, Prisma, ProConnect, ROSA, SenderBase, SMARTnet, Spectrum Expert, StackWise, WebEx, and the WebEx logo are registered trademarks of Cisco and/or its affiliates in the United States and certain other countries.

All other trademarks mentioned in this document or website are the property of their respective owners. The use of the word partner does not imply a partnership relationship between Cisco and any other company. (1002R)

© 2010 Cisco Systems, Inc. All rights reserved.