

Dialog 4223 Professional/Dialog 4225 Vision

System Telephones for Ericsson MX-ONE™ Telephony System and Ericsson MD110

D4 Mode

User Guide



EN/LZT 103 68 R5A

© Ericsson AB 2007

Table of Contents

Welcome	4
Important User Information	6
Description	7
Free Seating	28
Incoming Calls	29
Outgoing Calls	35
During Calls	52
Call Metering	59
Call Forwarding	62
Absence Information	76
Messages	79
Group features	85
Other Useful features	89
Settings	98
Accessories	117
Installation	124
Troubleshooting	132
Glossary	135
Index	136

Welcome

Welcome to the user guide for the *Ericsson Dialog 4223 Professional* and *Ericsson Dialog 4225 Vision*. This guide describes the available features of the telephones when they are connected to **Ericsson MX-ONE™ Telephony System** or **Ericsson MD110**.

The functions and features available with these telephones are designed for easy use in all different telephone handling situations.

Depending on the version and configuration of the exchange that your telephone is connected to, some of the functions and features that are described in this user guide may not be available. There may also be some differences in the way your telephone is programmed. Please consult your system administrator if you need further information.

Some markets use differing codes for some features. In this guide they are described using the most common code.

The latest version of the user guide can be downloaded from:
<http://www.ericsson.com/enterprise/library/manuals.shtml>

Copyright

All rights reserved. No parts of this publication may be reproduced, stored in retrieval systems, or transmitted in any form or by any means, electronic, mechanical, photocopying, recording or otherwise, without prior written permission of the publisher except in accordance with the following terms.

When this publication is made available on Ericsson media, Ericsson gives its consent to downloading and printing copies of the content provided in this file only for private use and not for redistribution. No parts of this publication may be subject to alteration, modification or commercial use. Ericsson will not be liable for any damages arising from use of an illegal modified or altered publication.

Warranty

ERICSSON MAKES NO WARRANTY OF ANY KIND WITH REGARD TO THIS MATERIAL, INCLUDING, BUT NOT LIMITED TO, THE IMPLIED WARRANTIES OF MERCHANTABILITY AND FITNESS FOR A PARTICULAR PURPOSE. Ericsson shall not be liable for errors contained herein nor for incidental or consequential damages in connection with the furnishing, performance or use of this material.

Declaration of conformity

Hereby, Ericsson AB, declares that this telephone, is in conformity with the essential requirements and other relevant provisions of the European R&TTE directive 1999/5/EC.

Details to be found at: <http://www.ericsson.com/sdoc>.



Important User Information

Safety instructions

Save these instructions.



Read these safety instructions before use!

Note: *When using your telephone or connected equipment, the following basic safety precautions should always be followed to reduce risk of fire, electrical shock and other personal injury.*

- Follow instructions in the equipment's user guide or other documentation.
- Always install equipment in a location and environment for which it is designed.
- For mains powered telephones: Only operate with the mains power voltage indicated. If you are uncertain of the type of power supplied to the building, consult property management or your local power company.
- For mains powered telephones: Avoid placing the telephone's power cable where it can be exposed to mechanical pressure as this may damage the cable. If the power supply cord or plug is damaged, disconnect the product and contact qualified service personnel.
- Headsets used with this equipment must comply with EN/IEC 60950-1 and for Australia AS/NZS 60950: 2000.
- Do not make any changes or modifications to equipment without seeking approval from the party responsible for compliance. Unauthorized changes or modifications could void the user's authority to operate the equipment.
- Do not use the telephone to report a gas leak in the vicinity of the leak.
- Do not spill liquid of any kind on the product or use the equipment near water, for example, near a bathtub, washbowl, and kitchen sink, in a wet basement or near a swimming pool.
- Do not insert any object into equipment slots that is not part of the product or auxiliary product.
- Do not disassemble the product. Contact a qualified service agency when service or repair work is required.
- Do not use a telephone (other than cordless type) during an electrical storm.

Disposal of the product



Your product should not be placed in municipal waste. Please check local regulations for disposal of electronic products.

Description

Dialog 4223 Professional

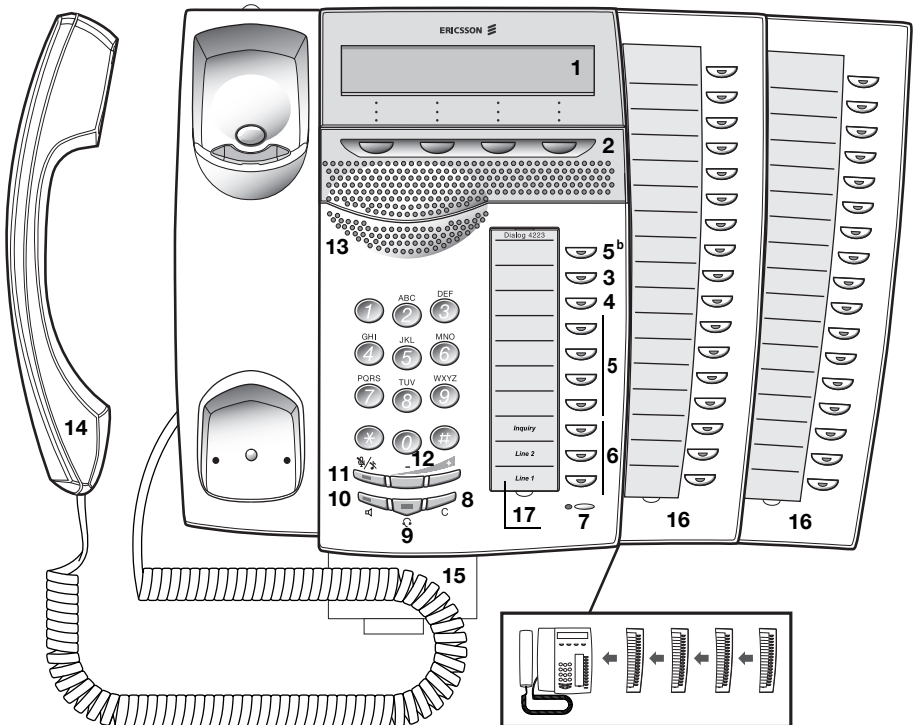

1 Display

See section “[Display information](#)” on page 16.

2 Display menu keys

The key functions depend on the traffic state. When you are requested “(see display)”, press the required key to access the feature.

3 Callback

Indicating/activating Callback. See section “[When you receive a busy tone](#)” on page 40. The feature can be removed or moved to another programmable function key by your system administrator.

4 Diversion (Follow-me)

Indicating/activating and deactivating Diversion (Follow-me). See section [“Call Forwarding”](#) on page 62. The feature can be removed or moved to another programmable function key by your system administrator.

5 Programmable function keys

Program numbers or features. See section [“Programming of function keys”](#) on page 98.

***Note:** The key marked with a “b” is also used to program a melody; see section [“Melody Ringing”](#) on page 109.*

6 Triple Access Line

Handle calls. Line 1 and 2 are available both for incoming and outgoing calls. Inquiry can only be used for outgoing calls.

7 Microphone

Used for handsfree conversation.

8 Clear

Disconnect calls or exit a feature. Can always be pressed instead of replacing the handset.

9 Headset key

Handle headset calls and activate Headset Preset. See section [“Headset \(optional\)”](#) on page 118.

10 Loudspeaker on/off

- a. Activate handsfree conversation. See section [“During Calls”](#) on page 52.
- b. Activate Loudspeaker Preset. See section [“Headset Preset”](#) on page 119.

11 Mute

- a. Switch the microphone on or off during a call. See section [“Mute”](#) on page 53.
- b. Switch off the ring signal in idle mode or when ringing. See section [“Mute ring signal”](#) on page 108 and [“Silent Ringing”](#) on page 108.

12 Volume control

Adjust the volume. See section [“Settings”](#) on page 98.

13 Loudspeaker

14 Handset

Supplied with hearing aid feature as standard. An extra handset can be connected, see section “[Accessories](#)” on page 117.

Please note: *The handset can attract and trap small metal objects in the earcap region.*

15 Pull-out leaf for easy guide (optional)

See section “[Pull-out leaf \(optional\)](#)” on page 121.

16 Key panel

With 17 programmable keys. Up to four panels can be connected. See section “[Key panel](#)” on page 117. Use the Designation Card Manager to make and print your own key panel designation cards, see below.

17 Designation card

Use the DCM (Designation Card Manager) to make and print your own designation cards. DCM is included on the Enterprise Telephone Toolbox CD or it can be downloaded from:

<http://www.ericsson.com/enterprise/library/manuals.shtml>

For more information, please contact your Ericsson Enterprise certified sales partner.

D4 mode information

The Dialog 4223 Professional phone can be connected to the exchange in two different modes (user interfaces), either D3 mode, or D4 mode. There is one user guide for each mode.

To find out the mode for your telephone, check the right hand side of the second row of the display (see picture), when the telephone is in idle mode:

- No extension number is shown (i.e. blank) - your telephone is using D4 mode = This is the correct guide.
- Extension number is shown - your telephone is using D3 mode = This is not the correct guide, download the user guide from: <http://www.ericsson.com/enterprise/library/manuals.shtml>

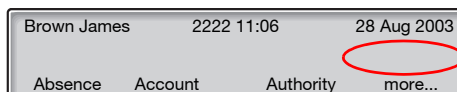

Note: *This user guide is not valid for the Dialog 4223 Professional in D3 mode.*

Dialog 4225 Vision

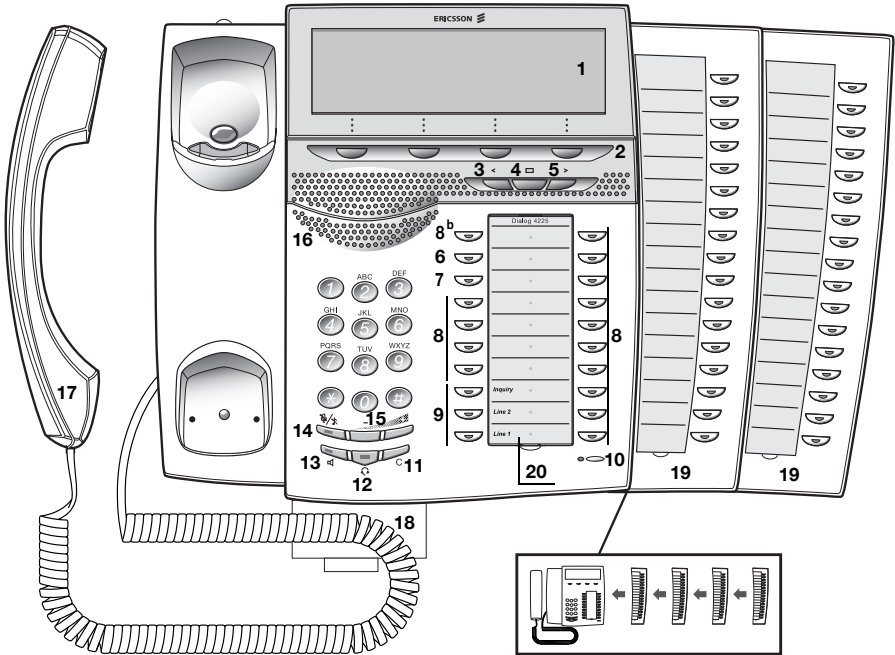

- 1 Display**
See section “[Display information](#)” on page 16.
- 2 Display menu keys**
The key functions depend on the traffic state. When you are requested “(see display)”, press the required key to access the feature.
- 3 Navigation key left**
Navigate one step to the left in the top menu. See section “[Display information](#)” on page 16.
- 4 Home**
Return to home position (idle mode), when you are navigating the top menu. See section “[Display information](#)” on page 16.
- 5 Navigation key right**
Navigate one step to the right in the top menu. See section “[Display information](#)” on page 16.

- 6 Callback**
Indicating/activating Callback. See section “[When you receive a busy tone](#)” on page 40. The feature can be removed or moved to another programmable function key by your system administrator.
- 7 Diversion (Follow-me)**
Indicating/activating and deactivating Diversion (Follow-me). See section “[Call Forwarding](#)” on page 62. The feature can be removed or moved to another programmable function key by your system administrator.
- 8 Programmable function keys**
Program numbers or features. See section “[Programming of function keys](#)” on page 98.
- Note: The key marked with a “b” is also used to program a melody; see section “[Melody Ringing](#)” on page 109.*
- 9 Triple Access Line**
Handle calls. Line 1 and 2 are available both for incoming and outgoing calls. Inquiry can only be used for outgoing calls.
- 10 Microphone**
Used for handsfree conversation.
- 11 Clear**
Disconnect calls or exit a feature. Can always be pressed instead of replacing the handset.
- 12 Headset key**
Handle headset calls and activate Headset Preset. See section “[Headset \(optional\)](#)” on page 118.
- 13 Loudspeaker on/off**
- Activate handsfree conversation. See section “[During Calls](#)” on page 52.
 - Activate Loudspeaker Preset. See section “[Headset Preset](#)” on page 119.
- 14 Mute**
- Switch the microphone on or off during a call. See section “[Mute](#)” on page 53.
 - Switch off the ring signal in idle mode or when ringing. See section “[Mute ring signal](#)” on page 108 and “[Silent Ringing](#)” on page 108.
- 15 Volume control**
Adjust the volume. See section “[Settings](#)” on page 98.
- 16 Loudspeaker**

17 Handset

Supplied with hearing aid feature as standard. An extra handset can be connected, see section “[Accessories](#)” on page 117.

Please note: *The handset can attract and trap small metal objects in the earcap region.*

18 Pull-out leaf for easy guide (optional)

See section “[Pull-out leaf \(optional\)](#)” on page 121.

19 Key panel





With 17 programmable keys. Up to four panels can be connected. See section “[Key panel](#)” on page 117. Use the Designation Card Manager to make and print your own key panel designation cards, see below.

20 Designation card

Use the DCM (Designation Card Manager) to make and print your own designation cards. DCM is included on the Enterprise Telephone Toolbox CD or it can be downloaded from: <http://www.ericsson.com/enterprise/library/manuals.shtml>

For more information, please contact your Ericsson Enterprise certified sales partner.

Lamp indications











	Extinguished lamp	The feature is not active.
	Steady light	The feature is active or the multiple represented line is busy.
	Slowly flashing lamp	The line (or feature) is put on hold.
	Rapidly flashing lamp	An incoming call.
	Light with short breaks	Ongoing call.

Tones and signals

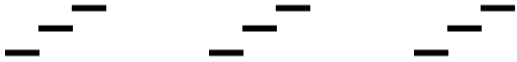
The following different tones and signals are sent from the exchange to your phone.

Tone characteristics

The tones shown in this section are the most used tones worldwide. Many markets use a differing tone for one or more situations.

Dial tone	
Special dial tone	
Ringing tone or queue tone	
Busy tone	
Congestion tone	
Number unobtainable tone	
Call waiting tone	
Intrusion tone	
Conference tone	
Verification tone	
Warning tone, expensive route	

Ring signals

Three different ring signals inform you about the type of the incoming call. The signals shown in this section are the most used signals worldwide. Many markets use signals that are adapted for the local standards. If you get a signal that is not described or you cannot identify, ask your system administrator.

Internal ring signal



External ring signal



Recall signal
(Callback reminder)



Display information

The display gives you feedback information such as time and date, traffic state and connected phone numbers. The following pages show examples of information displays from different telephone states.

Notes:

The order in which the date is stated is system dependent.

All names and numbers presented on the displays in this user guide are examples.

Your phone has a graphical display. The number of rows and characters per row depend on the character size and the font. When the display shows a list, or when the phone is in a setting mode, the middle field of the display is adapted to fit each situation.

Top menu (Dialog 4225 Vision)

The top menu is in the black frame below.

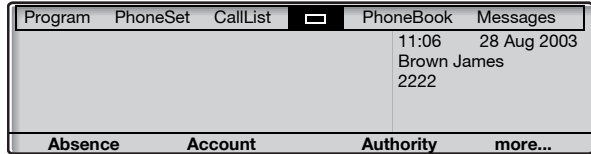

The following main text and symbols can be shown in the display's top menu (see also section "[Menu structure Dialog 4225 Vision](#)" on page 26.):

Program **Access the Program menu.**
See section "[Settings](#)" on page 98.

PhoneSet **Access the PhoneSet menu.**
See sections "[Settings](#)" on page 98, "[Accessories](#)" on page 117 and "[Troubleshooting](#)" on page 132.

CallList **Access the CallList menu.**
See section "[Call list](#)" on page 96.



Home position (idle mode).

PhoneBook **Access the PhoneBook menu.**
See section "[Dial by Phonebook](#)" on page 45.

Messages **Access the Messages menu.**
See section "[Messages](#)" on page 79.



Position indicator (selected top menu item).

Display symbols

Traffic status is indicated by the following symbols on the display:

Dialog 4223 Professional:

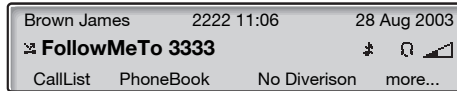

Dialog 4225 Vision:

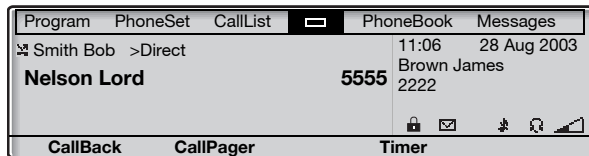

Forwarded call.

Indicates that the call is forwarded to another extension than the one dialed. See section “[Call Forwarding](#)” on page 62.



Prefix before type of forwarded call (Direct or Follow-me).

See section “[Call Forwarding](#)” on page 62.



Message.

Indicates that there is a message waiting. See section “[Messages](#)” on page 79.



Phone lock.

Indicates that the phone is locked for unauthorized calls. An authorization code must be used to make calls. See section “[Authority](#)” on page 49.



Headset Preset

Indicates that the phone is set for incoming and outgoing calls to be connected to the headset when you answer or make calls without lifting the handset. See section “[Headset \(optional\)](#)” on page 118.



Ringer off.

Indicates that the ring signal is switched off. See section “[Silent Ringing](#)” on page 108.



Volume level bar.

Indicates the ring signal volume in idle or ringing mode, or when in speech mode the loudspeaker or earpiece volume. For the Dialog 4223 Professional, the symbol is shown for a few seconds when a volume key has been pressed.

The following symbols can be shown in the top menus or other display lists (example of the **CallList** menu).

Dialog 4223 Professional:

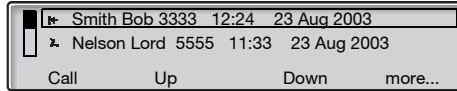

Dialog 4225 Vision:

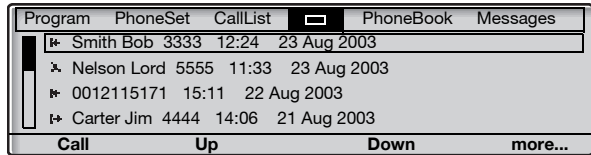

Missed call.

Indicates a missed but checked incoming call.



Incoming call.

Indicates an answered incoming call.



Outgoing call.

Indicates an outgoing call.



Bar indicator.

Indicates the shown part of the total list, and where it is positioned in the total list.



Selection frame.

Indicates the subject to be called or selected in the list.

Idle phone (idle mode)

Dialog 4223 Professional:

When your phone is idle, the upper row shows general information and your extension number. The lower row presents lead text for the display menu keys. In the example below, the extension number for **James Brown** is **2222**.

Note: *A long name overwrites the number.*

Brown James	2222 11:06	28 Aug 2003
Absence	Account	Authority more...

Dialog 4225 Vision:

When your phone is idle, the display shows the top menu. Below the top menu; time, date, name and your extension number are shown to the right. Below the line, lead text for the display menu keys are shown. In the example below, the extension number for **James Brown** is **2222**.

Program	PhoneSet	CallList	PhoneBook	Messages
			11:06	28 Aug 2003
			Brown James	2222
Absence		Account	Authority	more...

Outgoing call**Dialog 4223 Professional:**

When you make an outgoing call on your phone, traffic information and dialed name (if available) and number are shown.

Calling...	11:06	28 Aug 2003
Smith Bob		3333
Callback	CallPager	Timer

If the called party's phone is diverted, the forwarded call icon, the answering extension name (number when name is not available) and the type of diversion are shown.

☒ Smith Bob >Direct	11:06	28 Aug 2003
Nelson Lord		5555
Callback	CallPager	Timer

The call to Smith is directly diverted to Nelson (5555).

Dialog 4225 Vision:

When you make an outgoing call on your phone, the idle information is shown. Below the top menu; traffic information and dialed name (if available) and number are shown.

Program	PhoneSet	CallList	☐	PhoneBook	Messages
Calling...				11:06	28 Aug 2003
Smith Bob				3333	Brown James 2222
CallBack	CallPager			Timer	

If the called party's phone is diverted, the forwarded call icon, the answering extension name (number when name is not available) and the type of diversion are shown below the top menu.

Program	PhoneSet	CallList	☐	PhoneBook	Messages
☒ Smith Bob >Direct				11:06	28 Aug 2003
Nelson Lord				5555	Brown James 2222
CallBack	CallPager			Timer	

The call to Smith is directly diverted to Nelson (5555).

Incoming call***Dialog 4223 Professional:***

When you receive an incoming call, the calling party's extension number flashes (if the name is available, this is also shown). If the number for an external call is not available, the display shows **External** instead of the number (flashing).

	11:06	28 Aug 2003
Smith Bob		3333
Absence	Account	Authority more...

If a diverting extension is calling, the forwarded call icon, the called person's name (number when there is no name available), type of diversion, and the calling party's name and number (flashing) are shown.

☎ Smith Bob >Direct	11:06	28 Aug 2003
Carter Jim		4444
Absence	Account	Authority more...

Carter (4444) has called Smith and the call is directly diverted to you.

Dialog 4225 Vision:

When you receive an incoming call, the idle information is shown. Below the top menu, the calling party's extension number flashes (if the name is available, this is also shown). If the number for an external call is not available, the display shows **External** instead of the number (flashing).

Program	PhoneSet	CallList	PhoneBook	Messages
Smith Bob			3333	11:06 28 Aug 2003 Brown James 2222
Absence		Account		Authority more...

If a diverting extension is calling, the forwarded call icon, the called person's name (number when there is no name available), type of diversion, and the calling party's name and number (flashing) are shown below the top menu.

Program	PhoneSet	CallList	PhoneBook	Messages
☒ Smith Bob	>Direct		Jim Carter	4444
Absence		Account		Authority more...

Carter (4444) has called Smith and the call is directly diverted to you.

Display menu keys

The following text can be displayed for the display menu keys:

+/-	Adjust display contrast	HideMenu	Hide menu key designations
</>	Move cursor when programming melodies	Intrusion	Intrusion
Absence	Handle Absence/Diversion	Lock	Lock the phone
Account	Account Code	LogOn	Log on
Activate	Activate	LogOff	Log off
AddMember	Add member to a conference	more...	More menu choices
Authority	Authorization Code	n Missed	No. of missed calls in call list
Back	Return to previous menu	Next	Show next logged number
Back *	Return to previous menu	NoDiversion	Cancel Absence/Diversion
Call	Call the number displayed	NotDisturb	Do Not Disturb
CallBack	Callback	Open	Unlock the phone
CallList	Access Call list (Dialog 4223 Professional)	PhoneBook	Access Phonebook (Dialog 4223 Professional)
CallPickUp	Call pick-up	Program	Program
CallWaiting	Call waiting	Program *	Enter Program melody mode
Cancel DND	Cancel Do Not Disturb	Redial	Last Number Redial
Change *	Change a setting	Return	Return to previous menu keys
Clear	Reset time measurement	Save *	Save setting
Conf/Transf	To get a new line for conference or transfer	Save&Exit *	Save setting and exit menu
Conference	Connect a conference member	Select	Select item in a list
CommonHold	Put the call on common hold	ShowDate	Show date
Connect	Connect	ShowMenu	Show menu key designations
CostInfo	Display cost information	ShowTimer	Show timer
Deactivate	Deactivate	Space	Enter a space when writing names
Delete	Delete an item	Start/Stop	Start/Stop time measurement
Details	Show details for framed object	Timer	Display time measurement
Down	Scroll down	Tones	Dialing during a connected call (Push button tones, DTMF)
Exit	Exit the displayed menu	TraceMailC	Malicious Call Tracing
Exit *	Exit the displayed menu	Transfer	Execute a transfer
Enter	Enter values	Up	Scroll up
Find	Search	* Always displayed in English	
GrpPickUp	Group call pick-up		

Menu structure Dialog 4223 Professional

Menu structure for each of the menus that can be selected from the idle menu. When you are navigating the menus, a selected menu is marked with a black frame.

Idle display menu keys

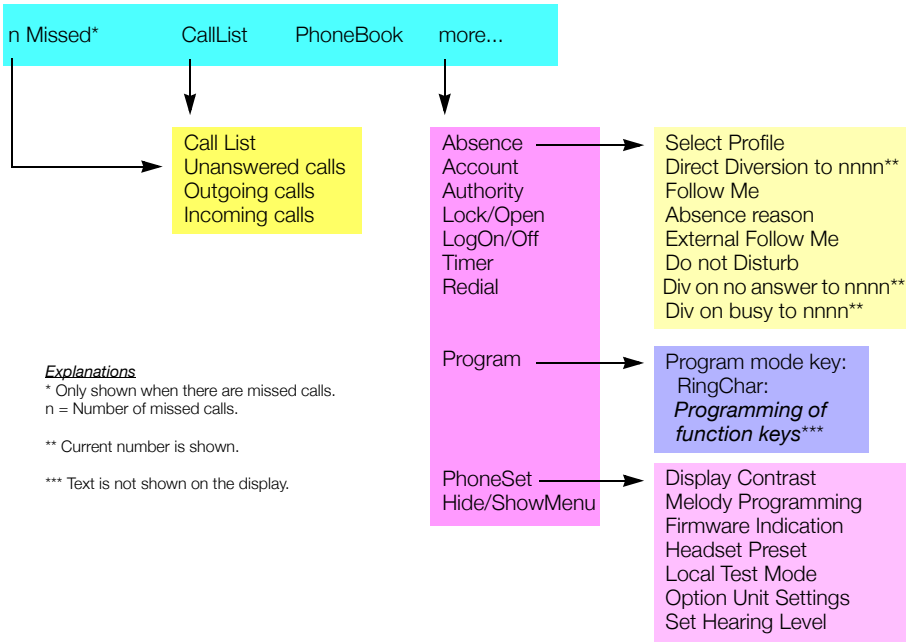

Menu structure Dialog 4225 Vision

Menu structure for each of the menus that can be selected from the idle menu. When you are navigating the menus, a selected menu is marked with a black frame.

Top menu

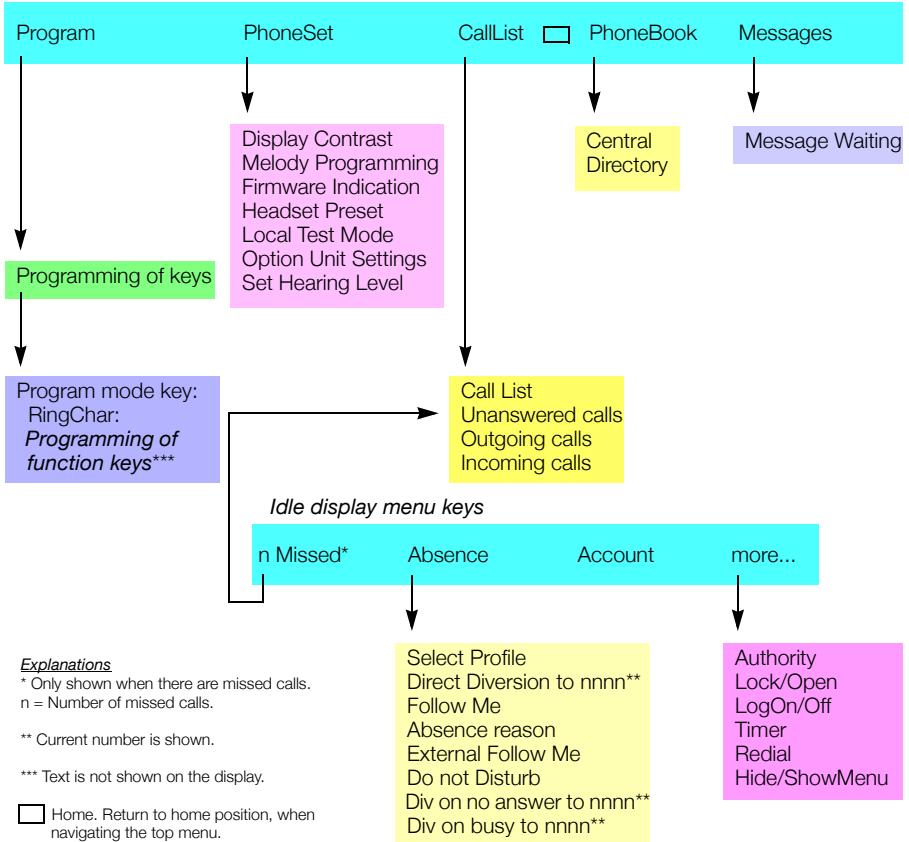

Display language (optional)

One of the following languages can be selected to display information on your phone.

Digit 0-9 = the language code:

0 English 1 French 2 German 3 Spanish 4 Italian
 5 _____ 6 _____ 7 _____ 8 _____ 9 _____

Note: *By default 5-9 are programmed for English. These can be changed locally to other languages.*

To select a language:

08

Dial.

(0-9)

Enter the language code.



Press.

Free Seating

The Free Seating feature is used for persons who have an office extension number but no phone set of their own. For example, flexible office workers, persons mostly working outside the office, etc. As a Free Seating user and working from the office, you logon to any free phone set that will be temporarily assigned with your extension number and your system authorities.

To log on

*** 1 1 ***

Dial.

⊙ ⊙ ⊙
⊙ ⊙ ⊙ *
⊙ ⊙ ⊙
⊙

Enter the Authorization Code and press.

⊙ ⊙ ⊙
⊙ ⊙ ⊙ #
⊙ ⊙ ⊙
⊙

Enter your phone number and press.



Press to finish the procedure.

The display shows your phone number.

To log off

1 1

Dial.



Press to finish the procedure.

Incoming Calls

Answer calls

A ring signal and a flashing lamp indicate an incoming call.

Note: If the feature *Parallel Ringing* is activated, the call will ring on more than one phone, see section "[Parallel Ringing](#)" on page 33.

On Line 1

Normally you will receive calls on Line 1.



Lift the handset.

On any other Line key

Lift the handset.



Press the flashing Line key.

Handsfree



Press the flashing Line key.

You are connected to the caller via the loudspeaker and the microphone.



Press to terminate a handsfree call.



On another extension

You can answer a call to another extension.

Call the ringing extension.

Busy tone.

Busy	11:06	28 Aug 2003
Smith Bob		3333
Callback	CallPager	CallPickUp more...

Program	PhoneSet	CallList	PhoneBook	Messages
Busy			11:06	28 Aug 2003
Smith Bob			3333	Brown James 2222
CallBack	CallPager		CallPickUp	more...

Note: *The display images might differ from the above.*

CallPickUp

Press to answer (see display).

If CallPickUp is not shown, press more... until it appears.

Notes:

*You can also press **8** or On hold/Pick-up (The function key is programmed by you).*

*France, press **4**; Sweden, press **6***

Answer a second call during an ongoing call

If your phone is preprogrammed with a Free on 2nd key, you can receive another call, if this feature is activated.

Free on 2nd 

Press to activate/deactivate.

When Free on 2nd is active the lamp is on.

Note: *The function key is preprogrammed by your system administrator.*

When you have an ongoing call on Line 1, and Line 2 flashes to indicate a new incoming call:

Line 2 

Press to answer.

The first call is put on hold.

Line 1 

Press to switch back to the first call.

The second call is put on hold. You are connected to the first caller.



Press to terminate the connected call.

Call Waiting

If the calling party has activated Call Waiting, you can receive a second call even if Free on 2nd is not activated.

To answer the waiting call:



Press to terminate the connected call.

Your phone will ring to announce the waiting call.

Line 

Press the flashing Line key to receive the new call.

Do Not Disturb, DND

When you activate DND, calls to your extension are not shown. Outgoing calls can be made as usual.

NotDisturb

Press to activate or deactivate DND (see display),

If NotDisturb is not shown, press more... until it appears.

or

Absence

press (see display).

If Absence is not shown, press more... until it appears.

Down or Up

Press to frame Do not Disturb (see display).

Activate

Press (see display).

Exit

Press (see display).

Cancel:

NoDiversion

Press (see display).

Notes:

If your phone is programmed with "Multiple Directory Diversion and Do Not Disturb" (ask your system administrator), DND is ordered and cancelled simultaneously on all lines.

You can also press DND (The function key is preprogrammed by your system administrator), or use these procedures:

*To activate, dial * 2 7 # and press the Clear key.*

To deactivate, dial # 2 7 # and press the Clear key.

Parallel Ringing

The Parallel Ringing feature makes it possible for an incoming call to ring several phones simultaneously and for the call to be answered on any of the phones. The main advantage of this feature is that you do not risk losing any calls.

The feature requires all the phones involved to be defined in a *Parallel Ringing list*, which must be configured and initiated by your system administrator. Because only calls to a main extension will be distributed among the phones in the list, this main extension also needs to be defined.

A call to a specific extension will not be distributed to other phones in the list, and will only ring that specific extension's phone.

Parallel Ringing can be temporarily disabled by the phone user using the feature "Internal Follow-me". See also section "[Internal Follow-me](#)" on page 66.

To disable Parallel Ringing temporarily

Absence
Down or Up

Press (see display).

Press (see display).

Repeat until the **Follow-me** menu is framed.

Select
⊙ ⊙ ⊙
⊙ ⊙ ⊙
⊙ ⊙ ⊙
⊙

Press (see display).

Enter the extension number.

If you want to disable Parallel Ringing for all phones defined in the list, follow the procedure for disabling the feature from the phone with the main extension number and enter the number of the answering position. If you want to disable Parallel Ringing for one specific phone in the list only, follow the procedure for disabling the feature from this phone and enter its extension number.

Notes:

*You can also use the following procedure to activate Follow-me: dial * 2 1 * (U.K. * 2 *), dial the extension number of the phone, press # and press the Clear key.*

The Follow-me key cannot be used to disable Parallel Ringing.

Enter

Press (see display).

The Follow-me key lamp is now on.

NoDiversion

To restore Parallel Ringing

Press (see display).

The Follow-me key lamp is off.

Notes:

*You can also use the following procedure to cancel Follow-me: dial **# 2 1 #** (U.K. **# 2 #**) and press the Clear key.*

If you want to restore Parallel Ringing for all phones defined in the list, follow the procedure for restoring the feature from the phone with the main extension number and enter the number of the answering position.

If you want to restore Parallel Ringing for one specific phone in the list only, follow the procedure for restoring the feature from this phone and enter its extension number.

The Follow-me key cannot be used to restore Parallel Ringing.

Outgoing Calls

Make calls

How to make internal and external calls:



Lift the handset and proceed depending on call type:

Internal calls



Dial the extension number.

External calls

0

Press the digit or digits to get an external line.

Dial tone.

Note: The particular digit or digits used in your office, e.g. **0** or **00**.



Dial the external number.

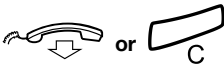

Replace the handset or press to end the call.

Note: If you receive a queue tone when dialing the digit or digits to get an external line (if feature Least Cost Routing is used in the system), keep waiting. Once a line becomes free you will receive a dial tone. If a warning tone is heard, the selected line is marked "Expensive".



Handsfree

With the handset on hook:

Dial the number.

You are connected via the loudspeaker and microphone.

Press to terminate a handsfree call.

Note: You can dial your calls more quickly by using common Speed Dialing numbers and by using your own programmed function keys. See section “Speed Dialing” on page 44.

Number Presentation Restriction

If you do not want your name and number to be displayed to the person you are calling, use the following procedure.

Note: The Number Presentation Restriction is only valid for the ongoing call, i.e. the procedure has to be repeated the next time you want to use it.

***42#**



Dial and wait for a new dial tone.

Dial the number.

Instead of your name and number, the display on the called phone shows **Anonymous**.

Individual External Line

To make a call on a specific external line:

*** 0 ***

Dial.

⊙⊙⊙
⊙⊙⊙
⊙⊙⊙
⊙

#

Dial the Individual External Line number and press.

⊙⊙⊙
⊙⊙⊙
⊙⊙⊙
⊙

Dial the digit or digits to get an external line and the external number.

Redial calls from the Call list

To use the Call list, see section “Call list” on page 96.

Dialog 4223 Professional

CallList

Press (see display).

Down or Up

Press to frame the requested list (see display).

Select

Press (see display),

The picture below is an example of how the display looks when the complete Call list has been selected.

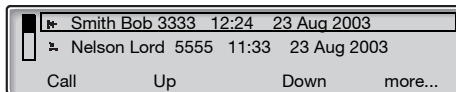

or use the shortcut directly to the unanswered calls list,

n Missed

press (see display).

n = Number of missed calls.

Down or Up

Press to frame a phone number (see display).

Call

Press to call the framed phone number (see display).



Down or Up
Select

Dialog 4225 Vision

Select CallList in the top menu (see display).

Press to frame the requested list (see display).

Press (see display),

The picture below is an example of how the display looks when the complete Call list has been selected.

Program	PhoneSet	CallList	PhoneBook	Messages
* Smith Bob	3333	12:24	23 Aug 2003	
* Nelson Lord	5555	11:33	23 Aug 2003	
* 0012115171	15:11	22 Aug 2003		
* Carter Jim	4444	14:06	21 Aug 2003	
Call	Up	Down	more...	

or use the shortcut directly to the not answered calls list,

n Missed

press (see display).

n = Number of missed calls.

Down or Up
Call

Press to frame a phone number (see display).

Press to call the framed phone number (see display).

Last External Number Redial

When you initiate an external call the system automatically stores all the dialed digits, irrespective of whether the call was successful or not.



Lift the handset.

Press to repeat the stored number (see display).

If **Redial** is not shown, press **more...** until it appears. The last external number is automatically redialed.

Notes:

*You can also dial * * * or press Last Number Redial (The function key is programmed by you).*

*Finland and Sweden, dial * * 0*

Save external number

When you make an external call, you can save the number in order to redial the same number easily. Any number previously saved is erased.

To save an external number:



Press before you finish the call.

Note: *The function key is preprogrammed by your system administrator.*

Redial number

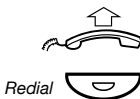

Lift the handset.

Press to redial the number.

Note: *The function key is preprogrammed by your system administrator.*

When you receive a busy tone

If you call an extension and receive a busy tone, or get no answer, or all external lines are busy, you can use any of the following methods:

Callback

If a called extension is busy or there is no answer:

Ca11BaCk

Press (see display).

It can take several seconds before the procedure is executed. If Ca11BaCk is not shown, press MORE... until it appears.

Notes:

*You can also press **6** or Callback (The function key is programmed by you).*

*France, Finland and Sweden, press **5***



Replace the handset to finish the procedure.

You are called back (recall ring signal) when the ongoing call is finished or the next time a new call is finished. You have to answer within eight seconds, otherwise the Callback service is cancelled. While waiting for the Callback, you can make and receive calls as usual.



Lift the handset when you are called back.

The system calls the extension.

Note: *Callbacks can be activated on several extensions at the same time. Callbacks from additional lines will recall on Line 1.*

If all external lines are busy (after dialing the digit or digits to get a line):

CallBack

Press (see display).

If CallBack is not shown, press **more...** until it appears.

Notes:

You can also press **6** or *Callback* (The function key is programmed by you).

France, Finland and Sweden, press **5**



Dial the external number and press.

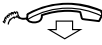

Replace the handset to finish the procedure.

When an external line becomes free you will be called back (recall ring signal). You have to answer within eight seconds, otherwise the Callback service is cancelled. While waiting for the Callback, you can make and receive calls as usual.



Lift the handset when you are called back.

The system calls the external number.

Note: Only one Callback can be activated on a busy external line. Callbacks from additional lines will recall on Line 1.

Cancel any single Callback

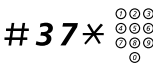

Dial and enter the extension number.

Note: To cancel a single Callback on a specific external line, dial the digit or digits to get a line instead of the extension number.



Press.

Cancel all Callbacks



Dial.



Press.

CallWaiting

Activate Call Waiting

If you urgently wish to contact a busy extension or external line, you can notify the extension by a Call Waiting signal.

Press (see display).

If CallWaiting is not shown, press **more...** until it appears.

Notes:

*You can also press **5** or Call Waiting (The function key is programmed by you).*

*France and Finland, press **6**; Sweden, press **4***

Keep handset off hook. When the called extension or the external line becomes free, it will be called automatically.

Note: *The Call Waiting feature might be blocked for use on your extension (preprogrammed by your system administrator). If Call Waiting is not allowed you will continue to receive a busy tone.*

Intrusion

Intrusion on a busy extension

You can intrude on an ongoing call on a busy extension.

Press.

If Intrusion is not shown, press **more...** until it appears.

Notes:

*You can also press **4** or Intrusion (The function key is programmed by you).*

*France and Sweden, press **8***

Before the Intrusion is executed a warning tone is sent to the parties in the ongoing call. A three party call is established and a warning tone is heard.

Note: *The warning tone might be disabled for your system. The Intrusion feature might be blocked for use on your extension (preprogrammed by your system administrator). If Intrusion is not allowed, you will continue to receive a busy tone.*

✖ 4 4 ✖



#



Intrusion

Intrusion on a busy external line

You can intrude on an ongoing call on a busy external line.

Dial and enter the Individual External Line number.

Press and dial the digit or digits to get an external line.

Busy tone.

Press.

If Intrusion is not shown, press more... until it appears.

Notes:

*You can also press **4** or Intrusion (The function key is programmed by you).*

*France and Sweden, press **8***

Before the Intrusion is executed a warning tone is sent to the parties in the ongoing call. A three party call is established and a warning tone is heard.

Note: *The warning tone might be disabled for your system. The Intrusion feature might be blocked for use on your extension (preprogrammed by your system administrator). If Intrusion is not allowed you will continue to receive a busy tone.*

Bypass

If this feature is allowed from your extension, you can bypass an; activated Diversion, activated Follow-me or activated Absence Information on a specific extension.

✖ 6 0 ✖



#

Dial and enter the extension number.

Press and wait for answer.

Speed Dialing

Common Speed Dialing numbers

By using common Speed Dialing numbers, you can make calls simply by pressing a few keys. The common Speed Dialing numbers consist of 1–5 digits and are stored in the exchange (by your system administrator).



Lift the handset and dial the common Speed Dialing number.

Individual Speed Dialing numbers

You can program up to ten frequently used phone numbers on the digit keys 0–9 and use them as individual Speed Dialing numbers (if this feature is allowed).

Note: In Finland, up to nine numbers, keys 1–9.

To use:

*** * (0–9)**

Dial and press the relevant digit.

Note: Finland, dial * * (1–9); Sweden, dial (0–9) #.

To program and alter individual Speed Dialing numbers:

*** 5 1 * (0–9)**

Dial and press the selected digit.

Note: Finland, dial * 5 1 * (1–9).



Press and dial the phone number.



Press.

Note: The programmed number may consist of a maximum of 20 digits plus *, which indicates the second dial tone from the public network.

5 1 * (0 - 9)



To erase one programmed number:

Dial and press the selected digit.**Note:** *Finland, dial # 5 1 * (1 - 9)***Press.**

To erase all programmed numbers:

5 1

**Dial.****Press.****Dial by a function key**

Both features and phone numbers can be programmed on a function key. To program a key, see section "[Programming of function keys](#)" on page 98.

Head office**Press the function key.**

This function key is programmed by you.

Dial by Phonebook

By use of the Integrated Telephone Directory you can search for a name, group, operator, etc. via your display and then call the desired person or group by use of a menu function key below the display.

On the Dialog 4223 Professional:

PhoneBook

Press to enter the Phonebook (see display).**Continue with any of the Phonebook options.***On the Dialog 4225 Vision:***Select PhoneBook in the top menu (see display).****Press (see display).****Continue with any of the Phonebook options.**

Phonebook options:

- Delete** **Press to delete the last entered character (see display).**
- Space** **Press to enter a space (see display).**
- Find** **Press to search using the entered characters (see display).**
- Exit** **Press to return to the previous menu (see display).**

Use the key pad to enter the characters of the name. The characters are shown above the keys.

Example:

Select characters by pressing digits repeatedly. The cursor is moved automatically when you stop pressing.



Press a digit.

- 1 time result A
- 2 times result B
- 3 times result C

When the desired character is shown on the display, wait for the cursor to move to the next place.

The name must be entered as follows:

Family name - Space - Name.

It is not necessary to enter all the characters, just as many to get as close as possible to the requested name when you start to search.

Note: *If you want to specify the person's first name, you must enter the full family name before you can enter a space.*

Example:

To search for Bob Smith:

7 7 7 7

Press for S

6

Press for M

4 4 4

Press for I

The display shows:

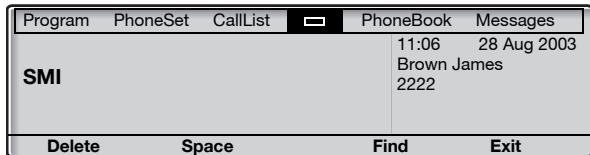
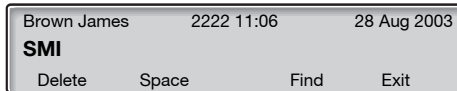

Find

Press to find (see display).

If SMI was sufficient to find Bob Smith, the display shows:

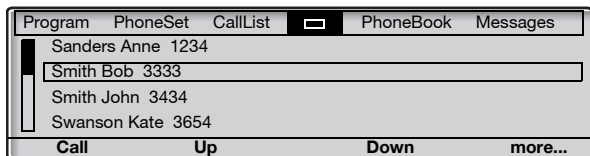
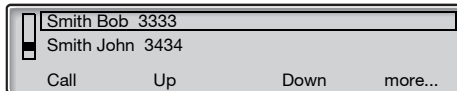

If SMI gives a name close to Bob Smith, e.g. Ann Smith, scroll down until you find the requested name.

Call	Press to call the framed number (see display).
UP	Press to scroll up through the name list (see display).
Down	Press to scroll down through the name list (see display).
more...	Press to show more options (see display).
Details	Press to show additional directory information (if available) for the framed name (see display).
Exit	Press to exit the PhoneBook menu (see display).
Back	Press to go back and enter a new name (see display).
Return	Press to return to the previous menu key options (see display).

The display will inform you if no name matches your search and show the name alphabetically preceding the name you entered.

Authority

Data privacy

Data privacy allows you to make a call without any disturbances, i.e. intrusion. This feature is automatically cancelled when the call is finished.

To order:



Lift the handset.

*** 4 1 #**

Dial and enter the number.

Authorization Code, common

If you are authorized to use a common Authorization Code (1 to 7 digits) you can temporarily change any phone used within the exchange to the authority level connected to this code. You can use the code for one call only or you can open the phone until you lock it when leaving the phone.

To use for a single call:

Authority

Enter

Press (see display).

If **Authority** is not shown, press **more...** until it appears.

Enter Authorization Code and press (see display).

Verification tone.

Note: You can also dial *** 7 2 ***, enter the code and press **#**.

Dial the digit or digits to get an external line and the external number.

To open an extension for several calls:

Open

Enter

Press (see display).

If **Open** is not shown, press **more...** until it appears.

Enter Authorization Code and press (see display).

Verification tone.

Note: You can also dial **# 7 3 ***, enter the code and press **#**.

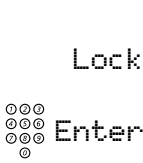

To lock an extension:

Press (see display).

If **Lock** is not shown, press **more . . .** until it appears.

Enter Authorization Code and press (see display).

Verification tone.

Note: *You can also dial *73*, enter the code and press #.*

Authorization Code, individual

If you are authorized to use an individual Authorization Code (1 to 7 digits, affiliated to your own extension) you can lock your own extension to a common authority level, e.g. when out of the office. You can also temporarily change any other phone used within the exchange to the same authority level as you have on your own phone. The individual code can be changed from your own extension.

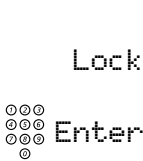

To lock your phone:

Press (see display).

If **Lock** is not shown, press **more . . .** until it appears.

Enter Authorization Code and press (see display).

Verification tone.

Note: *You can also dial *76*, enter the code and press #.*



To make calls with your authority level when your phone is locked:

Press (see display).

If **Authority** is not shown, press **more . . .** until it appears.

Enter Authorization Code and press (see display).

Verification tone.

Note: *You can also dial *75*, enter the code and press #.*



Dial the digit or digits to get an external line and the external number.

To open your phone:

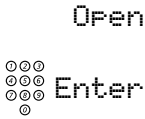

Press (see display).

If **Open** is not shown, press **more . . .** until it appears.

Enter Authorization Code and press (see display).

Verification tone.

Note: *You can also dial **# 7 6 ***, enter the code and press **#**.*

To assign your own authority level to another phone:



Dial.



Enter Authorization Code and press.

Verification tone.



Dial your own extension number and press.

Verification tone.



Dial the digit or digits to get an external line and the external number.

To change your individual Authorization Code:



Dial.



Enter old Authorization Code and press.



Enter new Authorization Code and press.

Verification tone.

During Calls

Group Listening (loudspeaking)

This feature lets other people in your room listen to your phone conversation. You speak in the handset while the other party's voice is heard on the loudspeaker.



During an ongoing conversation:

Press to switch between loudspeaker and handset.

When the key lamp is on, the other party's voice can be heard on the loudspeaker.

Note: You can adjust the volume, See section "[Settings](#)" on page 98.

From loudspeaking to handsfree



Replace the handset.

Handsfree conversation.

From handsfree to loudspeaking

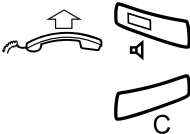

Lift the handset and press.

Press to end the call.

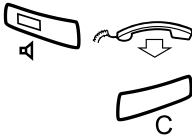

Handsfree

Press and replace the handset.
Handsfree conversation.

Press to end the call.



From handsfree to handset

Lift the handset.
Conversation via the handset.



Mute

Press to switch the microphone on or off.

When the lamp is on, the person on the line cannot hear what is being said near to your phone.

Inquiry

You have a voice connection on Line 1 and want to make an Inquiry to an internal or external party.



Press.

The first party is put on hold (Line 1 flashes slowly).

Note: *You can also press Line 2.*



Call the third party.

When the other party answers, you can switch between the calls (Refer Back), Transfer the call, create a Conference or end one of the calls.



Press to end the Inquiry call.

The third party is disconnected.



Press to return to the first call.

Refer Back

The Line key lamp flashes for the call put on hold.

Line 1 

Press to put third party on hold.

First call is connected.

Inquiry 

Press to put the first call on hold.

Third party is connected.

Note: You can also press Line 2 if you have initiated the Inquiry on Line 2.



Press to terminate the connected call.

Transfer

You have an ongoing call and you want to transfer the call to another extension.

Conf/Transf

Press (see display).

Note: You can also press Inquiry or a free Line key.



Call the third party.

Transfer

Press before or after answer (see display).

The ongoing call is transferred.

Note: If you have put more than one call on hold, the last call that was put on hold will be transferred. If the dialed extension is busy or Transfer is not allowed, your phone will ring again.

Conference

With this procedure you can include up to seven parties in a conference. Only the conference leader (i.e. the person initiating the conference) can admit participants. During the conference a tone will be heard every 15 seconds.

Note: *The conference tone might be disabled for your system.*

You have an ongoing conversation (Line 1) and want to establish a phone conference. You will become the conference leader.

Conf/Transf

Press (see display).

Note: *You can also press Line 2 or Inquiry.*



Call the third party.

Wait for answer.

Conference

Press to establish a conference (see display).

Note: *You can also press **3** or Conference (The function key is programmed by you).*

Repeat the procedure to add more conference members.



Replace the handset to leave the conference.

Note: *A tone is heard each time a participant enters or leaves the conference. When the conference leader leaves the conference, the conference will continue with the other included parties. The conversation is changed back to a normal two party connection when there are only two parties left.*

Hold

You can temporarily put the ongoing call on hold. Calls put on hold can be resumed on your own or on another phone.

Individual



Press the ongoing call Line key and replace the handset.

The key lamp flashes slowly.



Press the flashing Line key again to resume the call.

Common

CommonHold

Press (see display).

If CommonHold is not shown, press more... until it appears.

Notes:

*You can also press **8** or Hold/Pick-up (The function key is programmed by you).*

*France, press **4**; Sweden, press **6***



Replace the handset.

The key lamp flashes slowly. If your number is multiple represented on other phones, the key lamp that represents your number flashes slowly on these phones.

To resume the call on your own extension:



Press the flashing Line key.



CallPickUp

To resume the call on another extension:

Call the extension where the call was put on hold.

Press (see display).

If CallPickUp is not shown, press MORE... until it appears.

Notes:

You can also press **8** or Hold/Pick-up (The function key is programmed by you).

If your number is multiple represented on the phone, you can also press the key that represents your number.

France, press **4**; Sweden, press **6**

Send Caller Identity Code at transfer

When transferring a call you can send the caller's Identity Code or number to the receiver's display.

You have a voice connection with an external party on Line 1.

Conf/Transf

Press to put the call on hold (see display).

Note: You can also press Line 2 or Inquiry.

77

Dial.



Dial the caller's Identity Code or number and press.



Call the third party.

Transfer

Press before or after answer (see display).

The ongoing call is transferred with the caller's Identity Code or number.

Note: You can only use this feature if the receiver's phone is programmed to handle Identity Codes.

Dialing during a connected call

When calling interactive teleservices, e.g. telephone banks, you need to use Dual Tone Multi Frequency (DTMF) signals. If your exchange has not been programmed to automatically convert your entered digits into DTMF signals, you need to activate the feature during the call.



During an ongoing call:

Press (see display) and dial the requested digits.
Entered digits are transmitted as DTMF signals.

Notes:

*You can also press **9** and dial the required digits.*

*Finland, press **1** and dial the required digits.*

Call Metering

Cost information

Cost information for your call can be shown in the local currency in the display.

Cost in £	3.25	11:06	28 Aug 2003
R. Towers			0012345678
Tones	CostInfo	Conf/Transf	more...

Program	PhoneSet	CallList	PhoneBook	Messages
Cost in £			3.25	11:06 28 Aug 2003
R. Towers			0012345678	Brown James 2222
Tones	CostInfo		Conf/Transf	more...

CostInfo

Press to display or hide the cost indication (see display).

If `CostInfo` is not shown, press `more...` until it appears.

Note: The cost indication is automatically displayed for all charged calls, when the feature is activated.

Call Duration (Timer)

The elapsed time of your call can be measured, either manually (default) or automatically. To change to Automatic Timer, contact your system administrator.

Manual Timer

The timer can be activated when your phone is ready for dialing (internal dial tone is heard), during an outgoing call, or when you have a voice connection.

Note: System dependent, it can also be possible to activate Manual Timer when your phone is idle.

Timer

Press to activate the Call Duration feature (see display).

If `Timer` is not shown, press `more...` until it appears.

The display shows:

	11:06	00:00
R. Towers		0012345678
Start	Clear	ShowDate Exit

Program	PhoneSet	CallList	PhoneBook	Messages
			11:06	00:00
R. Towers		0012345678	Brown James	2222
Start	Clear	ShowDate	Exit	

Key functions that are available during call duration mode:

Start

Press to start the timer (see display).

The elapsed time is shown.

Clear

Press to clear the timer (see display).

ShowDate

Press to show date (see display).

Exit

Press to exit the Call Duration feature (see display).

Stop

Press to stop the timer (see display).

ShowTimer

Press to show the measured time (see display).

Automatic Timer

The timer automatically starts when the called person answers, and automatically stops when the call is finished. Both outgoing and incoming calls are measured.

If you make inquiries, conferences, or put calls on hold, etc. during the call, the timer is not stopped. I.e. the time measured is the total time from when the first called person answers, until the call to the last connected person is finished.

Note: *The timer shows the elapsed time from the last call until a new call has been answered. If you need to keep a record of your calls, always write down the time at once when a call has been finished.*

Timer

Press to show the Call Duration feature (see display).

If Timer is not shown, press more... until it appears.

The display shows:

	11:06	00:00
R. Towers		0012345678
	ShowDate	Exit

Program	PhoneSet	CallList	PhoneBook	Messages
R. Towers		0012345678	11:06 Brown James 2222	00:00
			ShowDate	Exit

Key functions that are available during call duration mode:

ShowDate

Press to show date (see display).

Exit

Press to exit the Call Duration feature (see display).

ShowTimer

Press to show the measured time (see display).

Call Forwarding

Diversion

If you do not want to be disturbed or will be out of the office, you can have all calls to your extension diverted to a preprogrammed answering position. During Diversion you will hear a special dial tone and the Diversion lamp indicates that your Triple Access Line is diverted. You can still make calls as usual.

Diversion can be made direct, on no answer, on busy or to another information service facility.

Note: *If your phone is programmed with "Multiple Directory Diversion and Do Not Disturb" (ask your system administrator), Diversion is ordered and cancelled simultaneously on all lines.*

Order Direct Diversion from your own extension

The call can be diverted to an individual position or up to three pre-determined common answering positions (depending on the type of the incoming call). Programmed by your system administrator.

Note: *Diversion can also be ordered and cancelled from the answering position, use the same procedure as in section “[Internal Follow-me](#)” on page 66.*

Diversion 

Press,

Note: *The function key is preprogrammed by your system administrator. If you order Diversion with the handset off hook or the loudspeaker on, press the Diversion key twice.*

or

Absence

press (see display).

If Absence is not shown, press more... until it appears.

Down or Up

Press to frame Direct Diversion to nnnn (see display).

(nnnn = number to the answering position, e.g. the operator).

Activate

Press (see display).

Exit

Press (see display).

Note: *You can also use the following procedure to activate: dial * 2 1 # (U.K. * 2 #) and press the Clear key.*

Cancel Direct Diversion from your own extension

Diversion 

Press,

Note: *The function key is preprogrammed by your system administrator.*

or

NoDiversion

press (see display).

Note: *You can also use the following procedure to cancel: dial # 2 1 # (U.K. # 2 #) and press the Clear key.*

Diversion when there is no answer

Order:

- Absence **Press (see display).**
If Absence is not shown, press more... until it appears.
- Down or Up **Press to frame Div on no answer to nnnn: Not active (see display).**
(nnnn = number to the answering position, e.g. the operator).
- Activate **Press (see display).**
- Exit **Press (see display).**
The incoming call is diverted after 3 signals.

Note: You can also use the following procedure to activate: dial *211# (Finland and Norway, *61#) and press the Clear key.

Cancel:

- Absence **Press (see display).**
If Absence is not shown, press more... until it appears.
- Down or Up **Press to frame Div on no answer to nnnn: Active (see display).**
(nnnn = number to the answering position, e.g. the operator).
- Deactivate **Press (see display).**
- Exit **Press (see display).**

Note: You can also use the following procedure to cancel: dial #211# (Finland and Norway, #61#) and press the Clear key.

Diversion when caller receives a busy tone*Order:*

Absence	Press (see display). If Absence is not shown, press more... until it appears.
Down or Up	Press to frame Div on busy to nnnn: Not active (see display). (nnnn = number to the answering position, e.g. the operator).
Activate	Press (see display).
Exit	Press (see display).

Note: You can also use the following procedure to activate:
dial * 2 1 2 # (Finland and Norway, * 6 7 #) and press
the Clear key.

Cancel:

Absence	Press (see display). If Absence is not shown, press more... until it appears.
Down or Up	Press to frame Div on busy to nnnn: Active (see display). (nnnn = number to the answering position, e.g. the operator).
Deactivate	Press (see display).
Exit	Press (see display).

Note: You can also use the following procedure to cancel:
dial # 2 1 2 # (Finland and Norway, # 6 7 #) and press
the Clear key.

Internal Follow-me

All calls to your extension are diverted to another extension of your choice (within the private network). The Follow-me lamp indicates that you have activated Follow-me. During Follow-me, your phone can still be used for outgoing calls and you will hear a special dial tone when you lift the handset.

Note: *If your phone is programmed with "Multiple Directory Diversion and Do Not Disturb" (ask your system administrator), Internal Follow-me is ordered and cancelled simultaneously on all lines.*

Order from your own extension

Absence	Press (see display). If Absence is not shown, press more . . . until it appears.
Down or Up	Press to frame Follow Me (see display).
Select	Press (see display).
	Dial the answering position number.
Enter	Press (see display).

Note: *You can also use the following procedures to activate: dial *21* (U.K. *2*), dial the answering position number, press # and press the Clear key, or lift the handset, press the Diversion key (The function key is preprogrammed by your system administrator), dial the answering position number, press the Diversion key again, and replace the handset.*



Cancel from your own extension

Press,

Note: The function key is preprogrammed by your system administrator.

or

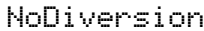

press (see display).

Note: You can also use the following procedure to cancel: dial **# 2 1 #** (U.K. **# 2 #**) and press the Clear key.

Redirect from answering position

If you move from one answering position to another answering position, you can redirect Follow-me from that new position.

Note: Internal Follow-me must be ordered from your own extension before you can redirect from answering position.

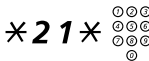

Dial and enter your own extension number.

Note: U.K., dial *** 2 * No.**



Press and enter the Diversion number.

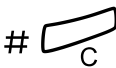

Press to redirect.

Calls are diverted to the answering position.

Cancel from answering position

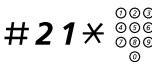

Dial and enter your own extension number.

Note: U.K., dial **# 2 * No.**

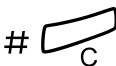

Press.

External Follow-me

If external Follow-me is allowed you can have all calls to your extension diverted to an external number of your choice. The Follow-me lamp indicates that you have activated Follow-me. During Follow-me, your phone can still be used for outgoing calls and you will hear a special dial tone when you lift the handset.

Order

Absence

Press (see display).

If Absence is not shown, press more... until it appears.

Down or Up

Press to frame External Follow Me (see display).

Select

Press (see display).



Enter the digit or digits to get an external line and enter the external number.

Enter

Press (see display).

Note: You can also use the following procedure to activate: dial *22#, enter the digit or digits to get an external line, enter the external number, press # and press the Clear key.

Cancel

Diversion



Press,

Note: The function key is preprogrammed by your system administrator.

or

NoDiversion

press (see display).

Note: You can also use the following procedure to cancel: dial #22# and press the Clear key.

Personal Number

With this feature you can be reached on your normal office phone number even if you are out of the office, at home, etc.

Depending on the functionality of your office exchange, you can have either one individual single search profile or you can choose between five individual search profiles.

A search profile can be designed to fit the situation, i.e. in the office, traveling, at home, etc. Both internal or external phone numbers can be used in a profile.

Your search profile is programmed or modified by your system administrator. See section [“To design and order your search profiles”](#) on page 72.

When the feature is activated, incoming calls are transferred to your selected phones or back-up services in the order that you choose. If an answering position in the profile is busy, the call can be transferred to another predefined position in the profile, i.e. Voice Mail or a colleague.

You can handle the profiles from your own office phone. How to do this is described in this section (an operator can also assist you).

You can also use any of the Personal Assistant applications, if available. Contact your system administrator for more information.

When out of the office, the feature Direct Inward System Access (DISA) can be used, if available in your system. How to use DISA is described in this section.

To activate or change to another profile from your office phone

- Absence **Press (see display).**
If Absence is not shown, press more... until it appears.
- Down or Up **Press to frame Select Profile (see display).**
- Select **Press (see display).**
- Down or Up **Press to frame the required profile (see display).**
- Select **Press (see display).**
The display shows the selected profile.

Notes:

*You can also use the following procedure to activate: dial *10*, enter the search profile digit (1-5), press # and press the Clear key.*

You can also activate/cancel and change to another profile by programming one function key/search profile (the function keys has to be pre-assigned by your system administrator). When the search profile is active the key lamp is on. See section "Settings" on page 98.

When another party is included in the activated profile, a colleague or an operator, etc., always remember to inform them about your absence. If Voice Mail is included in the activated profile, always update your greeting with Absence Information.

To cancel from your office phone

- Absence **Press (see display).**
If Absence is not shown, press more... until it appears.
- Down or Up **Press to frame Select Profile (see display).**
- Select **Press (see display).**
- Down or Up **Press to frame No Profile (see display).**
- Select **Press (see display).**

Note: *You can also use the following procedure to cancel: dial # 1 0 # and press the Clear key.*

To activate or change to another profile from an external phone

The external phone must be of push button type provided with pound key (#) and star key (*) or a mobile phone adapted for dial tone pulses (DTMF).



*** 7 5 ***

Call the DISA feature at your office.

Dial tone.

Dial.



Enter the Authorization Code and press.



Dial your own extension number and press.

Dial tone.

*** 1 0 ***

Dial.



Dial your own extension number and press.

(1 - 5)

Press the search profile digit.



Press and replace the handset.

Note: When another party is included in the activated profile, a colleague or an operator, etc., always remember to inform about your absence. If Voice Mail is included in the activated profile, always update your greeting with Absence Information.

To cancel from an external phone

The external phone must be of push button type provided with pound key (#) and star key (*) or a mobile phone adapted for dial tone pulses (DTMF).



*** 7 5 ***

Call the DISA feature at your office.

Dial tone.

Dial.



1 0 *

Dial the Authorization Code and press.

Dial your own extension number and press.

Dial tone.

Dial.



Dial your own extension number and press.



Replace the handset.

To design and order your search profiles

The search profiles are installed or changed by your system administrator. In order to set up your profiles, copy the setting form, fill in your new or changed profiles and give it to your system administrator.

Note: *If a profile handling application is connected to your system, you can edit profiles via your Intranet. See separate instructions for the application.*

Important notes when designing your search profiles:

- Avoid ring times longer than 45 seconds for your profiles.
Usually the caller hangs up after 3-6 ring signals. If you need a longer ring time, the maximum time is 60 sec.
- Consider the time you need to react and answer on each answering position in your profile.
You might need up to 15 seconds to react and answer a call on a desk or cordless phone and 20–25 seconds for a mobile phone.
- There must be an answering position at the end of every profile (Voice Mail or operator/secretary).
If not, calls might end up unanswered.
- Consider what should happen while you are busy on a phone.
The available options are:
 - *Activate Free on 2nd (if available)*
 - *Diversion to Voice Mail*
 - *Diversion to the operator*
- If an answering machine, a fax or other answering device is used as an early answering position, it might interrupt the searching.
Disconnect the answering device, or design the ring times so they do not affect the searching.
- If your system admits just one single personal profile, design the profile only with your 2–3 most frequently used positions.
If you add more numbers, there is a risk that the caller hangs up before a latter position is called.
- If your system admits 1–5 personal profiles, design the different profiles to fit your most frequently used positions.
Make sure you use as few answering positions as possible for each profile. Profile examples:
 - *In office*
 - *At home*
 - *Traveling*
 - *Absent/not reachable*

Example:

How to fill in your setting form for search profiles:

Profile 1

In office

Search order	Type of telephone or Answering position*	Telephone number	Ring time (seconds)
1	Desk	1234	10
2	Cordless	5234	15
3	Voice Mail		

* Examples: Desk, Cordless, Mobile, External, Voice Mail, Operator, etc.

Profile 2

At home

Search order	Type of telephone or Answering position*	Telephone number	Ring time (seconds)
1	External	222222	20
2	Mobile	0706666666	25
3	Voice Mail		

Setting form for search profiles

Name:

Department:

Telephone No:

Account:

Profile 1

Search order	Type of telephone or Answering position*	Telephone number	Ring time (seconds)
1			
2			
3			
4			

* Examples: Desk, Cordless, Mobile, External, Voice Mail, Operator, etc.

Profile 2

Search order	Type of telephone or Answering position*	Telephone number	Ring time (seconds)
1			
2			
3			
4			

Profile 3

Search order	Type of telephone or Answering position*	Telephone number	Ring time (seconds)
1			
2			
3			
4			

Profile 4

Search order	Type of telephone or Answering position*	Telephone number	Ring time (seconds)
1			
2			
3			
4			

Profile 5

Search order	Type of telephone or Answering position*	Telephone number	Ring time (seconds)
1			
2			
3			
4			

Absence Information

Absence Information is used to inform callers why you are absent and when you will return. If you are authorized, you can also enter Absence Information for another extension from your extension. During Absence Information, your phone can still be used for outgoing calls and you will hear a special dial tone when you lift the handset.

Order

- | | |
|------------|---|
| Absence | Press (see display).
If Absence is not shown, press MORE . . . until it appears. |
| Down or Up | Press to frame Absence reason (see display). |
| Select | Press (see display). |
| Down or Up | Press to frame the required reason (see display). |
| Select | Press (see display).
When no return time or date is needed, the display shows the selected reason, and diversion information. |

When a return time or date is requested:

0915

Enter the date (MMDD) or time (HHMM) of your return.
(Example shows "Back on September 15").

Note: *The order in which the date is stated is system dependent.*

Enter

Press (see display).

The display shows the selected absence reason, the time or date of return, and diversion information.

Note: *You can also use the following procedure to order: dial * 2 3 *, enter the absence code (0-9), enter time or date of return (if requested), press # and press the Clear key. The absence code is system dependent. Contact your system administrator regarding the available absence codes.*

Cancel

NoDiversion

Press (see display).

Note: *You can also use the following procedure to cancel: dial # 2 3 # and press the Clear key.*

Order for another extension

✳ 2 3 0 ✳

Dial.

⦿⦿⦿
⦿⦿⦿ ✳
⦿⦿⦿
⦿

Dial the extension number and press.

(0 - 9)

Enter the absence code.

✳ 0 9 1 5

Press and enter the date or time of the other person's return.

 C

Press.

The display on the other person's extension shows the reason for absence and, if entered, time or date of return.

Cancel for another extension

2 3 0 ✳

Dial.

⦿⦿⦿
⦿⦿⦿ #
⦿⦿⦿
⦿

Dial the extension number and press.

Note: If the special dial tone is received, the Authorization Code for the other extension is required. Add the code and press # before pressing the Clear key.

 C

Press.

Messages

Manual Message Waiting (MMW)

If the called extension does not answer you can initiate a message waiting indication on that extension (if this feature is allowed). If there is a message waiting, the Message key lamp is on and you will hear a special dial tone after lifting the handset.

Message 

Answer

Press.

Note: *The function key is preprogrammed by your system administrator.*

A call is initiated to the extension that requested Message Waiting.

Checking the party that requested MMW

Dialog 4223 Professional:

Program

Press (see display).

If Program is not shown, press more . . . until it appears.

Select

Press (see display).

Message 

Press.

Note: *The function key is preprogrammed by your system administrator.*

The number that requested Message Waiting is shown in the display.

Exit

Press to finish the procedure (see display).



Dialog 4225 Vision:

Select Program in the top menu (see display).

Press to select Programming of keys (see display).

Press.

Note: *The function key is preprogrammed by your system administrator.*

The number that requested Message Waiting is shown in the display.

Exit

Press to finish the procedure (see display).

Cancel MMW at your own extension

3 1

Dial.



Press.

Order MMW to another extension

In idle mode:

*** 3 1 ***

Dial.

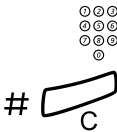

Dial the extension number.

Press.

The Message Waiting key lights up on the called extension.

Cancel MMW to another extension

3 1 *

Dial.

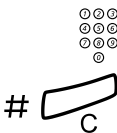

Dial the extension number.

Press.

Message Waiting

If assigned this feature and your phone is diverted to an interception computer, a function key (preprogrammed by your system administrator) will flash when there are messages stored for you in the computer. The messages will be printed out on a printer connected to the computer.

To print out messages

Message 

Press.

Note: *The function key is preprogrammed by your system administrator.*

The display shows the identity of the computer and the number of messages stored for you.

If you find that the notification of Message Waiting is intrusive or you want to shut off the notification:

9 1 # *

Dial.

Acknowledgement tone.

Voice Mail (optional)

The Voice Mail application allows you to leave a voice message to the caller when you are unable to answer calls, e.g. when out of office, in a meeting, etc. The caller can then leave a message in your mailbox. When back in your office you can enter your mailbox and listen to the messages received.

You can choose to divert all incoming calls to your mailbox, or calls when there is no answer, or calls when your phone is busy.

If you use the Personal Number feature, it is recommended to program Voice Mail as the last answering position for all search profiles.

When you enter your mailbox, you will hear recorded instructions on how to handle listening, recording, storing and deleting messages, and how to change your security code.

Note: *How to handle your mailbox, depends on the type of Voice Mail system. The following describes the, in MD110, integrated type. For other types, please refer to separate user instructions. Contact your system administrator if you do not know which type of Voice Mail system you have.*

To activate and deactivate your mailbox

For all incoming calls:

See “[Diversion](#)” on page 62 (procedure with code 21). Use the number to the Voice Mail system as the “answering position number”.

When incoming calls get no answer:

See “[Diversion](#)” on page 62 when there is no answer (procedure with code 211).

When incoming calls get a busy tone:

See “[Diversion](#)” on page 62 when caller receives a busy tone (procedure with code 212).

To access your mailbox

From your office phone:



Dial the number to the Voice Mail system.

Note: *If a function key is programmed for your mailbox and when the key lamp is on or flashing (= a new message is received), you can also press this key. On the Dialog 4225 Vision, you can also enter the top menu **Messages** and press **Select**. (see display).*

If you are asked to enter your security code:



Enter your security code.

Code at delivery = your extension number.

From another phone:



Dial the number to the Voice Mail system.

If you are asked to enter your security code (if the phone you are using has a mailbox of its own):

#

Press.



Dial your mailbox number.

(normally your office extension number)



Enter your security code (if required).

To access someone else's mailbox



Dial the number to the Voice Mail system.

If you are asked to enter your security code (if the phone you are using has a mailbox of its own):

#

Press.



Dial the mailbox number.

(normally the office extension number of the other person)



Enter the security code of the other person (if required).

To handle the mailbox

Recorded information on the line tells you the number of new and stored messages. If you have too many messages stored, you will first be asked to delete saved messages.

Recorded instructions ask you to press different digits in order to listen to callers' messages, record your own greetings, change your password or exit your mailbox, etc.

The following diagram gives an overview of the mailbox system and the digits to be used.

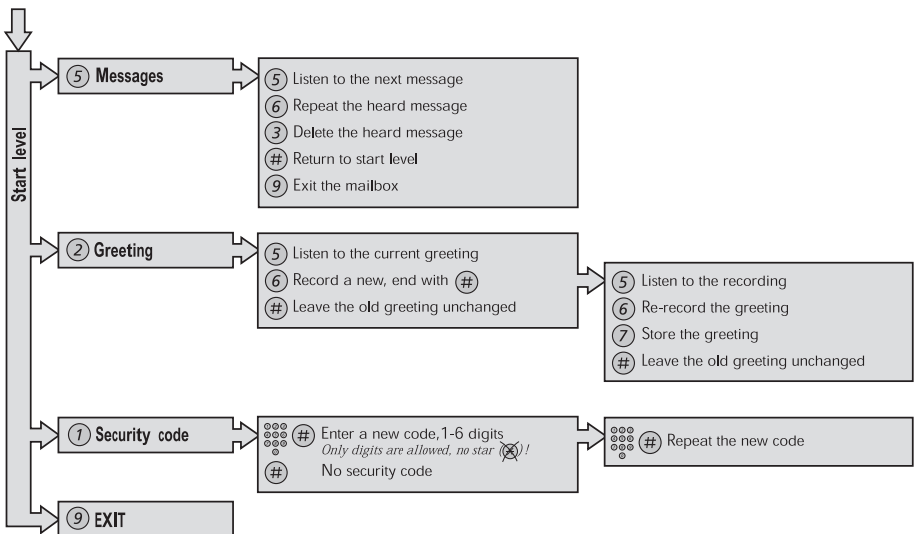

Group features

Group Call-pick-up

People working in a team can have their phones programmed by their system administrator to form Call Pick-up groups.

In a Call Pick-up group, any member can answer any individual call to group members.

GrPckUP

Press to answer (see display).

If **GrPckUP** is not shown, press **more . . .** until it appears.

Notes:

*You can also press **8**.*

One Call Pick-up group can serve as an alternative to another group. Calls to the alternative group can only be answered when there are no calls to your own group.

*Finland and Sweden, press **0***

Common Bell Group

Calls are signalled on a common bell.

GrPckUP

Press to answer (see display).

If **GrPckUP** is not shown, press **more . . .** until it appears.

Notes:

*You can also press **8**.*

*Finland and Sweden, press **0***

Group Hunting

An internal Group Hunting number is a common directory number for a group of extensions. Calls to the group will be indicated at a free extension in the group.

When you leave the group temporarily, you make your phone unavailable for incoming calls.

*** 2 1 *** 



To leave the group temporarily

Dial and enter your own extension number.

Note: U.K., dial * 2 * No.

Press.

To re-enter the group

2 1

Dial.

Note: U.K., dial # 2 #



Press.

If you are authorized you can divert all calls to your group, to another extension or group:

*** 2 4 ***

Dial.



Dial the number of the group to be diverted and press.



Dial the extension number of the new answering position.



Press.

To cancel the Diversion:

2 4 *

Dial.



Dial the number of the group that has been diverted.



Press.

Group Do Not Disturb

If your extension is defined as a master extension (preprogrammed by your system administrator), you can mark a group of extensions as Group Do Not Disturb. The group can be bypassed by you.

*** 2 5 *** 

To order:

Dial and enter the group number.

Note: *Germany and South Africa, dial * 2 8 * No.*



Press.

Special dial tone.

Press.

2 5 * 

To cancel:

Dial and enter the group number.

Note: *Germany and South Africa, dial # 2 8 * No.*



Press.

*** 6 0 *** 

To bypass:

Dial and enter the extension number.

#

Press.

The call is made to the specified extension in the group.

Other Useful features

Account Code

This feature is used to charge a call to an account number or to prevent unauthorised calls from your phone. The Account Code can have 1 to 15 digits.

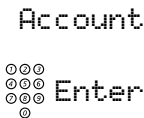

Press (see display).

If Account is not shown, press **more...** until it appears.

Dial the Account Code and press (see display).

Dial tone.

Note: You can also use the following procedure:
dial * 6 1 * (Finland and Norway, * 7 1 *), enter the
Account Code and press #.



Dial the digit or digits to get an external line and the external number.

Ongoing external call

When used to charge a call it is also possible to connect an ongoing external call to an Account Code. During the call:



Press the ongoing call Line key to put the call on hold.

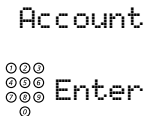

Press (see display).

If Account is not shown, press **more...** until it appears.

Dial the Account Code and press (see display).

Dial tone.

Note: You can also use the following procedure:
dial * 6 1 * (Finland and Norway, * 7 1 *), enter the
Account Code and press #.



Press the flashing Line key for the call put on hold.

Immediate Speech Connection

You automatically answer a call without lifting the handset or pressing any keys. The feature can be permanently active or activated by use of a function key (preprogrammed by your system administrator).

Permanently active

Program the ringing option with “Immediate Speech Connection with one ring signal”, option 6, on the Line key. See section “[Programming of ring signals](#)” on page 102.

Activated on a function key

Automatic answer



Press to order or cancel.

Note: *The function key is preprogrammed by your system administrator.*

The incoming call is signalled with one ring signal. When the key lamp is on you can use this feature.

General Deactivation

The following features can be simultaneously cancelled:

- Callback (all Callbacks are cancelled).
- Diversion/Internal and External Follow-me.
- Manual Message Waiting/Message Diversion.
- Do Not Disturb.

001



Order

Dial.

Press.

Night Service

When the exchange is in Night Service mode, all your incoming calls to the operator are transferred to a selected extension or group of extensions. The exchange has three different Night Service modes:

Common Night Service

All incoming calls to the operator are transferred to one specific extension. Answer the call in the normal way.

Individual Night Service

Selected external calls to the operator are transferred to one specific extension. Answer the call in the normal way.

Universal Night Service

All incoming calls to the operator are transferred to a universal signalling device, e.g. the common bell. Answer the call as described in section "[Common Bell Group](#)" on page 85.

Hot Line

This feature is programmed by your system administrator.

Delayed Hot Line

When the handset of the delayed Hot Line phone is lifted or when the Line key is pressed, a timer is started. If no digit is pressed before time out, a call is automatically generated to a specific extension or external line. If a digit is pressed before time out the phone works as an ordinary phone.

Direct Hot Line

The same feature as described above, but without a delay. Only Hot Line calls can be placed from this line. To be used e.g. as alarm phone, door phone etc.

Emergency mode

In the event of an emergency the operator can set the exchange into Emergency mode, during which only preprogrammed extensions are permitted to make calls. If your extension is not assigned with this category and you try to make a call, you will not receive a dial tone.

Additional Directory Number

You can be assigned (preprogrammed by your system administrator) one or more Additional Directory Numbers (lines) on free function keys.

To answer, make calls and use features on the additional directory lines, use the same procedure as for the Triple Access Line, unless you have other instructions. However, you have to press the additional Line key after lifting the handset.

Example:

To make a call on an additional directory line:



Lift the handset.

Press.

Note: *The function key is preprogrammed by your system administrator.*



Dial the extension number.

Multiple Represented Directory Number

Your extension number can be programmed on a dedicated key on other system telephones, i.e. your number is “represented” on these phones. Other extension numbers can of course also be “represented” on your phone.

Note: *This feature has to be programmed by your system administrator.*

Incoming calls

Incoming calls can be answered (indicated with a flashing key lamp, calling party information and/or ring signal) on all phones where the number is represented.

Outgoing calls

The dedicated key can be used to call the programmed extension. How outgoing calls are handled depends on the programming of the phone, please contact your system administrator regarding this.

Malicious Call Tracing

If you are disturbed by bothersome or malicious external incoming calls, you can request number tracing from the network provider.

You can invoke tracing during or after an ongoing conversation. The external line can be held for a limited period of time.

Order

During an ongoing conversation:

TraceMalC

Press (see display).

If TraceMalC is not shown, press more... until it appears.

Note: *You can also press Mal. Call Tracing (The function key is preprogrammed by your system administrator).*

The system acknowledges with different tones whether the tracing request was accepted or rejected.

DISA = Direct Inward System Access

If you are assigned to use this feature and you are working externally, you can call your office and get access to an external line in order to make business calls. The business call will be charged your office extension number or an account number. You will be charged just for the call to the office.

The external phone must be of push button type provided with pound key (#) and star key (*) or a mobile phone adapted for dial tone pulses (DTMF).

After a completed DISA call you must hang up before a new DISA call can be made.

There are different procedures depending on the type of Authorization Code, or when an Account Code is used.

With common Authorization Code

⊙⊙⊙
⊙⊙⊙
⊙⊙⊙
⊙

Call the DISA feature at your office.

Dial tone.

*** 7 2 ***

Dial.

⊙⊙⊙ #
⊙⊙⊙
⊙

Dial the Authorization Code and press.

Dial tone.

⊙⊙⊙
⊙⊙⊙
⊙⊙⊙
⊙

Dial the external number.

With individual Authorization Code

⊙⊙⊙
⊙⊙⊙
⊙⊙⊙
⊙

Call the DISA feature at your office.

Dial tone.

*** 7 5 ***

Dial.

⊙⊙⊙ *
⊙⊙⊙
⊙

Dial the Authorization Code and press.

⊙⊙⊙ #
⊙⊙⊙
⊙

Dial your own extension number and press.

Dial tone.

⊙⊙⊙
⊙⊙⊙
⊙⊙⊙
⊙

Dial the external number.

Call list

With this feature, calls to and from your phone will be logged. By use of the display menu keys below the display, you can browse the Call list, make calls to numbers in the list and delete numbers from the list.

You can choose to browse in the complete list of all calls, or in specific lists of unanswered, outgoing and incoming calls. When new unanswered calls have been stored in the list, *n Missed* is shown in the display (*n* = number of missed calls).

Your phone must be idle and unlocked to be able to browse the Call list.

To access the Call list

Dialog 4223 Professional:

CallList

Press (see display).

Down or Up

Press to frame the requested list (see display).

Select

Press (see display),

The desired list is displayed, see section “[Call list options](#)” on page 97.

or use the shortcut directly to the unanswered calls list,

n Missed

press (see display).

n = Number of missed calls.

Dialog 4225 Vision:



Select CallList in the top menu (see display).

Down or Up

Press to frame the requested list (see display).

Select

Press (see display),

The desired list is displayed, see section “[Call list options](#)” on page 97.

or use the shortcut directly to the unanswered calls list,

n Missed

press (see display).

n = Number of missed calls.

Call	Press to call the framed phone number (see display).
Down or Up	Press to frame a phone number in the list (see display).
more...	Press to show more options (see display).
Delete	Press to delete the framed call (see display).
Return	Press to return to the previous menu key options (see display).

Example of the complete Call list:

☛	Smith Bob	3333	12:24	23 Aug 2003
☛	Nelson Lord	5555	11:33	23 Aug 2003
Call Up Down more...				

Program	PhoneSet	CallList	PhoneBook	Messages
☛	Smith Bob	3333	12:24	23 Aug 2003
☛	Nelson Lord	5555	11:33	23 Aug 2003
☛	0012115171	15:11	22 Aug 2003	
☛	Carter Jim	4444	14:06	21 Aug 2003
Call Up Down more...				

The content of the Call list is (from left to right):

- Type of call symbol. See explanation below.
- Name of the calling/called person, e.g. "J Gilmour".
- Phone number of the calling/called person, e.g. "5467".
- Time of the call, e.g. "10:48".
- Date of the call.
- Bar indicator. Indicates the shown part of the total list, and where that part is positioned in the total list.

With the following call symbols displayed:

- ☛ **Missed call.**
Indicates a missed but checked incoming call.
- ☛+ **Incoming call.**
Indicates an answered incoming call.
- ☛➔ **Outgoing call.**
Indicates an outgoing call.

Settings

Programming of function keys

Frequently used features and phone numbers can be programmed on the function keys for easy access. When you want to use the feature, just press the key. Certain features must be preprogrammed by your system administrator. Both phone numbers and feature codes can be programmed on a function key.

Enter programming mode

Dialog 4223 Professional:

Program

Press (see display).

If **Program** is not shown, press **MORE . . .** until it appears.

Select

Press (see display).

Continue with “Program or change a feature”.

Dialog 4225 Vision:



Select

Select Program in the top menu (see display).

Press to select Programming of keys (see display).

Continue with “Program or change a feature”.

Program or change a feature



Press the key to program or change.

Notes:

*If the key is already programmed, the number or feature will be displayed. If you do not want to change the programmed feature, press **Exit** to leave the menu without saving the changes.*

*To erase a programmed feature, press the Clear key, and press **Exit** to leave the menu.*



Enter phone number or a feature code according to the list in section “Features and required data”.

Notes:

If a wrong number is entered, press the Clear key to erase it, and then enter the number again.

You can continue programming another function key (repeat from “Press the key to program or change”).



Exit

Press the function key again.

Press to finish programming (see display).

Remove the transparent cover and write the feature name or phone number beside the key.

Note: Use the DCM (Designation Card Manager) to make and print your own designation cards. DCM is included on the Enterprise Telephone Toolbox CD or it can be downloaded from:

<http://www.ericsson.com/enterprise/library/manuals.shtml>

For more information, please contact your Ericsson Enterprise certified sales partner.

Features and required data

Feature	To be entered on the function key			
Dial by a function key	Extension number or procedure			
	Feature code			
	Most common	Finland	France	Sweden
Call pick up:				
Group	8		4	6
Individual	No. + 8		No. + 4	No. + 6
Call Waiting	5	6	6	4
Conference	3			
Intrusion on busy extension	4		8	8
Last External Number Redial	xxx	xx0		xx0
Hold, common	8		4	6
Personal Number (list no.)	(1-5)			

Features that can only be programmed by your system administrator:

- Additional lines
- Dedicated intercom link
- Do Not Disturb*
- Free on 2nd
- Individual External Line
- Manual Message Waiting
- Name and Number Log
- Callback*
- Diversion*
- External line
- Immediate Speech Connection*
- Malicious Call Tracing
- Multiple representation
- Search profile lists and pre-assigning of function keys for Personal Number

**The feature can also be programmed by you.*

When the feature has been programmed *by you*, you *will not* get a toggle function. Instead you will have one key for activation and another key for deactivation. The key lamp *will not* indicate that the feature is activated.

When the feature has been programmed *by your system administrator* you *will get* a toggle function and the key lamp will indicate that the feature is activated.

Programming of ring signals

You have 6 programmable ring signals on your phone. The different signals can be programmed on lines, additional lines and multiple represented lines.

Enter programming mode

Dialog 4223 Professional:

Program

Press (see display).

If Program is not shown, press more . . . until it appears.

Select

Press (see display).

Continue with “Program or change a ring signal”.

Dialog 4225 Vision:



Select

Select Program in the top menu (see display).

Press to select Programming of keys (see display).

Continue with “Program or change a ring signal”.

Program or change a ring signal**Line 1** **Press the corresponding Line key.**

A digit (0–6) is shown in the display.

Note: *If you do not want to change the programmed ring signal, press **Exit** to leave the menu without saving the changes.*

(0 – 6)**Select the ring signal you want to use according to the list below.**

- 0 = Silent.
- 1 = Periodic ring signal.
- 2 = Delayed periodic ring signal.
- 3 = One muted ring signal.
- 4 = One muted delayed ring signal.
- 5 = Immediate Speech Connection with one ring signal controlled by function key.
- 6 = Immediate Speech Connection with one ring signal.

Note: *Options 5 and 6 are not available for multiple represented lines.*

Line 1 **Press.****Exit****Press to finish programming (see display).**

Programming of ring signal tone character

There are 10 different programmable ring signal tone characters on your phone, each corresponding to a digit between 0 and 9.

Note: *If you use melodies to signal incoming calls, this will replace the tone character. See section "Melody Ringing" on page 109.*

Dialog 4223 Professional:

Program

Press (see display).

If Program is not shown, press more... until it appears.

Select

Press (see display).

The current tone character is displayed.

(0-9)

Press the corresponding digit.

The phone rings with the chosen tone character.

Exit

Press to finish programming (see display).

Dialog 4225 Vision:



Select

Select Program in the top menu (see display).

Press to select Programming of keys (see display).

The current tone character is displayed.

(0-9)

Press the corresponding digit.

The phone rings with the chosen tone character.

Exit

Press to finish programming (see display).

Handset and loudspeaker volume

Use the Volume keys to adjust the volume of the handset or loudspeaker during a call. Adjust the handset listening volume when the handset is off hook. Adjust the loudspeaker volume when dial tone is heard via the loudspeaker, or during a handsfree call.



Press to change the volume.

The handset and loudspeaker volume level is stored.

To adjust the volume during Group Listening:



Replace the handset.



Press to change the volume.

The handset and loudspeaker volume level is stored.



Lift the handset and press.

Extra amplification of the handset/headset hearing volume level

For people with impaired hearing, the handset hearing volume level can be extra amplified. To adjust the level:

Note: A level change also effects a headset connected to the headset outlet.

Dialog 4223 Professional:

PhoneSet

Press (see display).

If PhoneSet is not shown, press more . . . until it appears.

Select

Press (see display).

Down or Up

Press to frame Set Hearing Level (see display).

Select

Press (see display).

A tone signal is heard, and the display shows the current setting. The Line 1 key lamp also indicates the current setting; key lamp off=standard level, key lamp on=increased level.

Change

Press to adjust the volume level (see display).

The display shows the new setting. The Line 1 key lamp also indicates the new setting as described above.

Exit

Press to finish setting (see display).

When extra amplification has been selected, the Line 1 key lamp turns off.

	<i>Dialog 4225 Vision:</i>
	Select PhoneSet in the top menu (see display).
Down or Up	Press to frame Set Hearing Level (see display).
Select	Press (see display). A tone signal is heard, and the display shows the current setting. The Line 1 key lamp also indicates the current setting; key lamp off=standard level, key lamp on=increased level.
Change	Press to change the volume level (see display). The display shows the new setting. The Line 1 key lamp also indicates the new setting as described above.
Exit	Press to finish setting (see display). When extra amplification has been selected, the Line 1 key lamp turns off.

Ring signal volume



Use the Volume keys to adjust the ring signal volume when the phone is in idle mode or ringing. Adjusted volume is stored.

Press to adjust the volume.

Mute ring signal



You can suppress the ring signal for an incoming call.

Press to suppress the ring signal.

The ring signal is switched off for the current call, and your phone is automatically set to Silent Ringing (see below).

Silent Ringing

If you do not want to be disturbed by the ring signal but still want to answer an incoming call, you can switch off the ring signal. Incoming calls are only indicated by a flashing line lamp and display information.



When the phone is in idle mode, or when ringing:

Press to switch off the ring signal.

The Mute key lamp and the Ringer off symbol are switched on to indicate Silent Ringing. The ring signal will automatically be switched on the next time you Lift the handset or press any key.

Melody Ringing

If you want to replace the ring signal with personal melodies when your phone rings, you can program one melody to signal an internal call, a second melody for an external call and a third melody to signal a Callback call.

Dialog 4223 Professional:

PhoneSet

Press (see display).

If PhoneSet is not shown, press more... until it appears.

Select

Press (see display).

Down or Up

Press to frame Melody Programming (see display).

Select

Press (see display).

Continue with section Melody mode.

Dialog 4225 Vision:



Select PhoneSet in the top menu (see display).

Down or Up

Press to frame Melody Programming (see display).

Select

Press (see display).

Continue with section Melody mode.

Melody mode

The display shows Melody Mode and if there is a stored and activated melody for internal calls (Line 1), external calls (Line 2) or Callback calls (Inquiry), the corresponding key lamp is switched on.

In melody mode you can:

- Program new melodies
- Edit or delete stored melodies
- Activate or deactivate stored melodies

Exit

Press if you want to exit melody mode (see display).

Note: If you do not press any key within 30 seconds, melody mode is automatically cancelled.

Program a new melody, edit or delete a current melody

Program

Press (see display).

The display shows **Program Melody**. The upper most function key lamp (for Dialog 4225 the upper most key to the left) is also switched on, indicating Program mode.

Press the key for the requested type of call:

If there is a current melody, the melody is played and the last 19 notes or signs are displayed.

Line 1 

Press for internal calls,

or

Line 2 

press for external calls,

or

Inquiry 

press for Callback calls.

To edit the current melody:

 **or** 

Press to move the cursor to the right of the position to be edited (see display).



Press to erase the note to the left of the cursor.

Keep pressed to erase all the notes.

To enter a new melody or notes, see section ["To enter notes"](#) on page 113.

To store the current melody:



Press the flashing Line key (Line 1 or Line 2 or Inquiry).

If you do not want to continue to program or delete a melody for another line:



Press to return to the previous menu (see display).

Note:

The melody is not yet activated, see section “[Activate or deactivate a stored melody](#)” on page 112.

If no key is pressed within 30 seconds, all entered notes or changes will be automatically stored, and the phone returns to idle mode.



To delete the current melody:

Press and hold until no notes are displayed.



Press the flashing Line key (Line 1 or Line 2 or Inquiry).

If you do not want to continue to program or delete a melody for another line:



Press to return to the previous menu (see display).

Note: *If no key is pressed within 30 seconds, the change will be automatically stored, and the phone returns to idle mode.*

Activate or deactivate a stored melody

A stored melody has to be activated in melody mode to be heard when you get an incoming call.

To activate (in melody mode):



Press the key for the requested type of call (Line 1 or Line 2 or Inquiry).

The corresponding key lamp is switched on:

Line 1 key = Internal calls

Line 2 key = External calls

Inquiry key = Callback calls

Note: *If you want to return to an ordinary ring signal but keep the melody stored, press again the key for the requested type of call. When the key lamp is off, the stored melody is deactivated.*

Exit

Press to exit melody mode (see display).

1c 2d 3e
 4f 5g 6a
 7b 8+c 9+d

To enter notes

In melody mode, the key pad is used to enter notes, pauses, etc. A maximum of 40 notes can be programmed for incoming calls, and 20 notes for recalls.

This is how the keys are used:

Press to insert notes (1–9).

Note: A short press gives a short note, a long press gives a long tone (displayed by a capital letter), +c and +d means the higher octave.

✳

Press to insert a short pause (p).

Hold to get a long pause (P). Repeat to get a longer pause (pp...p).

0

Press to get a higher octave for the inserted note.

A + is shown in front of the note to indicate the higher octave.

Example: 30 to get +e

#

Press to increase or decrease the pitch for the inserted note.

Press once for sharp pitch, twice for flat pitch and three times to get the normal pitch.

< or >

Press to move the cursor to the left or to the right (see display).



Press to listen to the entered notes.

Press to erase the note to the left of the cursor.

Keep pressed to erase all the notes.

Melody example:

James Bond theme programmed for internal calls:

C d d D D pp C C C C #d #d #D #D pp D D D ##A G pppp G F G

Enter the notes.

Grey digit = Long press.

1 2 2 2 ✳ ✳ 1 1 1
 1 2 # 2 # 2 # 2 #
 ✳ ✳ 2 2 2 6 # # 5
 ✳ ✳ ✳ ✳ 5 4 5

Note: The # key (to get a sharp or flat tone) is pressed after the note, but is displayed before the note.

When the first 19 positions are entered, the display shows (only last entered 19 positions can be shown):

Program Intern CddDDppCCCC#d#d#D#D< < > Back
--

Program Intern CddDDppCCCC#d#d#D#D< < > Back
--

When all the notes are entered, the display shows (only last entered 19 positions are shown):

Program Intern #D#DppDDDbAGppppGFG< < > Back
--

Program Intern #D#DppDDDbAGppppGFG< < > Back
--

Note: The flat A (##A) is shown as bA, i.e. b is used to show both the note b and the flat sign.

Display contrast

You can adjust the contrast for the display.

Dialog 4223 Professional:

PhoneSet	Press (see display). If PhoneSet is not shown, press more... until it appears.
Select	Press (see display).
Down or Up	Press to frame Display Contrast (see display).
Select	Press (see display).
- or +	Press repeatedly to adjust the contrast (see display).
Save&Exit	Press to save the setting and exit the menu (see display).

Note: To exit the menu without saving the changes, press Save&Exit before you press any of the adjustment keys.

Dialog 4225 Vision:

	Select PhoneSet in the top menu (see display).
Down or Up	Press to frame Display Contrast (see display).
Select	Press (see display).
- or +	Press repeatedly to adjust the contrast (see display).
Save&Exit	Press to save the setting and exit the menu (see display).

Note: To exit the menu without saving the changes, press Save&Exit before you press any of the adjustment keys.

Display backlight

(Dialog 4225 Vision phone only).

You can adjust the backlight for the display.



Down or Up
Select

Select PhoneSet in the top menu (see display).

Press to frame Backlight (see display).

Press (see display).

- or +

Save&Exit

Press repeatedly to adjust the backlight (see display).

Press to save the setting and exit the menu (see display).

Note: *To exit the menu without saving the changes, press Save&Exit before you press any of the adjustment keys.*

Accessories

Key panel

Your phone can be equipped with 1-4 additional key panels (type DBY 419 01). Each key panel offers 17 additional keys for storing of your most frequently used telephone numbers and features, and for supervising extensions. To install the key panel, see section “[Installation](#)” on page 124.

Use the DCM (Designation Card Manager) to make and print your own key panel designation cards. DCM is included on the Enterprise Telephone Toolbox CD or it can be downloaded from: <http://www.ericsson.com/enterprise/library/manuals.shtml>

For more information, please contact your Ericsson Enterprise certified sales partner.

Headset (optional)

To install the headset, see section “[Installation](#)” on page 124.

The following headset features are available.

Answer calls



Press to answer.

The Headset key lamp is turned on.

Note: When the phone is set for Headset Preset, you can also press the flashing Line key to answer the call. See section “[Headset Preset](#)” on page 119.



Press to terminate the headset call.

Make calls

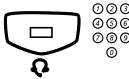

Press and dial the number.

The Headset key lamp is turned on.

Note: When the phone is set for Headset Preset, you can also dial the number directly without pressing the Headset key, or you can press a Line key instead of the Headset key. See section “[Headset Preset](#)” on page 119.



Press to terminate the call.

From headset to handset



Lift the handset.

From handset to headset

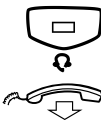

Press.

The Headset key lamp is turned on.

Replace the handset.



Headset with Group Listening (loudspeaking)

Press to toggle between headset with or without Group Listening.

When the Loudspeaker key lamp is on, the Group Listening is active.



From headset to handsfree

Press.

The Loudspeaker key lamp is turned on.



Press.

From handsfree to headset

Press.

The Headset key lamp is turned on.



Headset Preset

By default the phone is set to *Loudspeaker Preset mode*, so that calls are connected to the loudspeaker when you answer or make calls by pressing a Line key. Also when you dial the number without lifting the handset, the call is automatically connected to the loudspeaker.

When you use a headset for your telephone, you can change the setting to *Headset Preset mode* to get calls connected to the headset instead. In Headset Preset mode you can make headset calls by pressing digits directly (direct dialing). You can also answer headset calls by pressing a Line key.

Notes:

Independent the type of preset setting, when you lift the handset the call is always connected to the handset.

Also handsfree and loudspeaking work as usual, i.e. when the Loudspeaker key is pressed, the call is temporarily connected to the loudspeaker.

Activation and deactivation of Headset Preset can only be done when the telephone is in idle mode.



To activate Headset Preset:

Press and hold for at least 4 seconds.

A short acknowledgement tone signal is heard, and the Headset Preset symbol is shown in the display.

Note: *You can also activate Headset Preset, via the PhoneSet menu.*



To cancel Headset Preset:

Press and hold for at least 4 seconds.

A short acknowledgement tone signal is heard, and the Headset Preset symbol is switched off in the display.

Note: *You can also cancel Headset Preset, via the PhoneSet menu.*

Headset volume

During a call, use the Volume keys to change the volume of the headset.



Press to change the volume.

The set headset volume level is stored.

To adjust the volume for the loudspeaker of the phone during Group Listening:

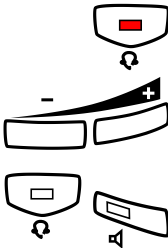

Press.

Press to change the volume.

The Loudspeaker volume level is stored.

Press.

For those with impaired hearing, the headset hearing volume level can be further amplified, use the same procedure as described in section "[Handset and loudspeaker volume](#)" on page 105.

Extra handset (optional)

The extra handset is used in parallel with the ordinary handset allowing another person to listen to an ongoing call. The extra handset is connected to the headset outlet under the phone, see section “[Installation](#)” on page 124.

It is possible to switch between the speaking party and the listening party.



Press to switch between the speaking and listening party.

Note when speaking: *For good speech quality, only one person at the time should speak.*

Pull-out leaf (optional)

The pull-out leaf is used for a personal telephone number list and is installed under the phone. To install the pull-out leaf, see section “[Installation](#)” on page 124.

Use the DCM (Designation Card Manager) to make and print your own card for the pull-out leaf. DCM is included on the Enterprise Telephone Toolbox CD or it can be downloaded from: <http://www.ericsson.com/enterprise/library/manuals.shtml>

For more information, please contact your Ericsson Enterprise certified sales partner.

Option unit (optional)

The option unit DBY 420 01/1 is an optional accessory to be installed under your telephone set. The unit is used to connect either an extra bell outside your room, or a busy signal lamp outside your door.

To check or set the option unit for extra bell or for busy signal

Dialog 4223 Professional:

PhoneSet

Press (see display).

If PhoneSet is not shown, press more... until it appears.

Select

Press (see display).

Down or Up

Press to frame Option Unit Settings (see display).

Select

Press (see display).

The Line 2 key lamp indicates the setting of the option unit: Off=Extra bell, On=Busy signal lamp. Flashing=Combined extra bell & busy lamp.

Line 2 

Press to change to busy signal,

or

Line 2 

press to change to extra bell & busy signal,

or

Line 2 

press to change to extra bell.

Exit

Press to save the setting and exit (see display).

Note: If you do not press Exit, the phone automatically returns to idle about 30 seconds after the last key press.

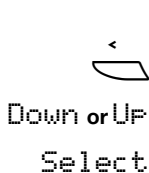

Dialog 4225 Vision:

Select PhoneSet in the top menu (see display).

Press to frame Option Unit Settings (see display).

Press (see display).

The Line 2 key lamp indicates the setting of the option unit:
Off = Extra bell, On = Busy signal lamp. Flashing=Combined extra bell & busy lamp.



Press to change to busy signal,

or



press to change to extra bell & busy signal,

or



press to change to extra bell.

Exit

Press to save the setting and exit (see display).

Note: *If you do not press Exit, the phone automatically returns to idle about 30 seconds after the last key press.*

Installation

Install cables

Handset cable to the left

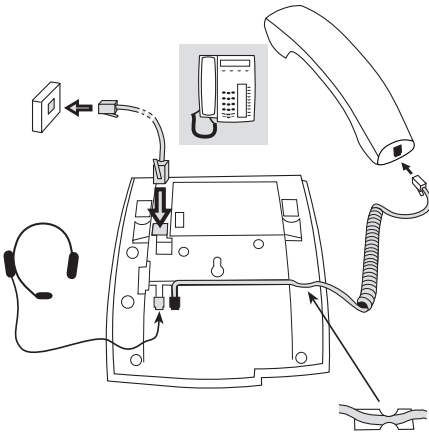

Handset cable to the right

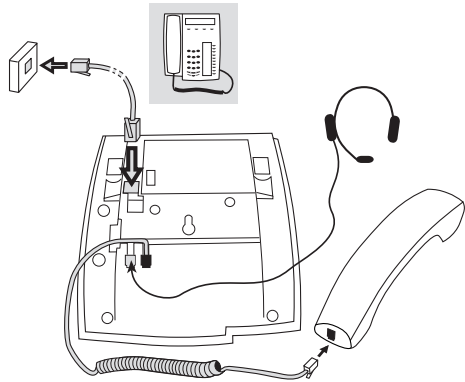

You can put the cable to the handset into the notch underneath the telephone. The cable to the exchange has to be plugged into "LINE" and the handset cable has to be plugged into "HANDSET".

Change cables

To remove a cable, use a screwdriver to unlock the stop.

Install stands and adapt telephone

Position high

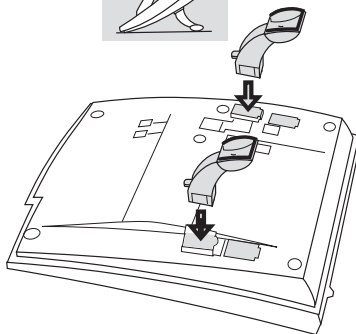

Position low

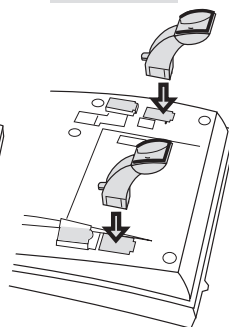

Press to fasten stand

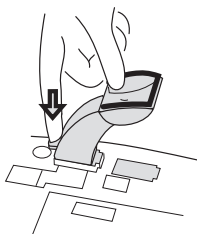

Release to remove stand

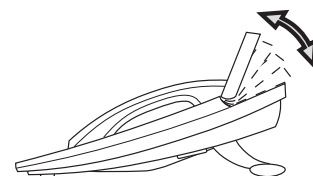
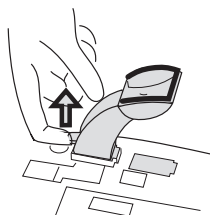

Tiltable display

Adjustable angle

Install card

Use the DCM (Designation Card Manager) to make and print your own designation cards. DCM is included on the Enterprise Telephone Toolbox CD or it can be downloaded from: <http://www.ericsson.com/enterprise/library/manuals.shtml>

For more information, please contact your Ericsson Enterprise certified sales partner.

Dialog 4223 Professional:

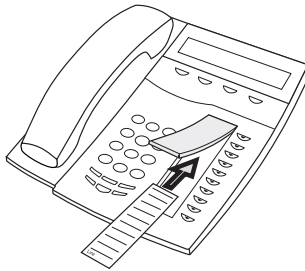

Dialog 4225 Vision:

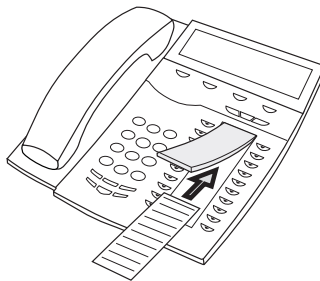

Install key panels

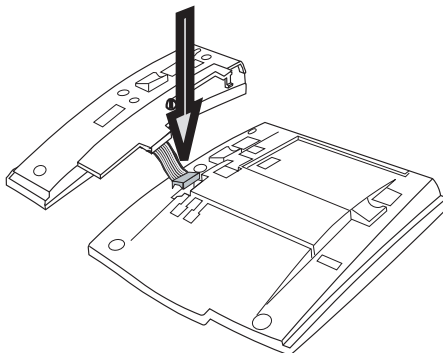

- 1 Fasten the connector in the bottom of the hole using a finger or a blunt tool. Make sure the connector fits before pressing it down.**

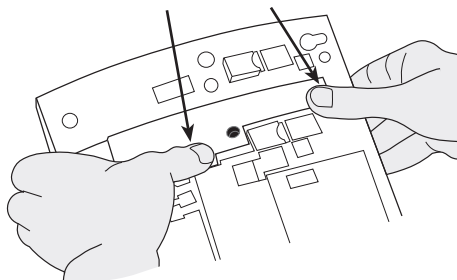
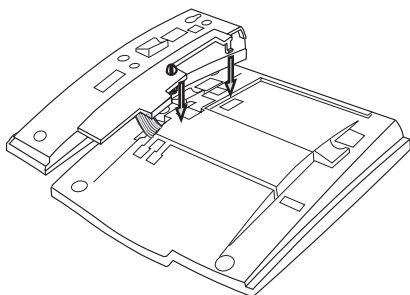

- 2 Press where the arrows are pointing, until you hear a “Click” sound.**
- 3 Install the stands as shown in the picture in section “Stand positioning”.**

Notes:

All key panels must be of type DBY 419 01.

Stand positioning (1-4 key panels)

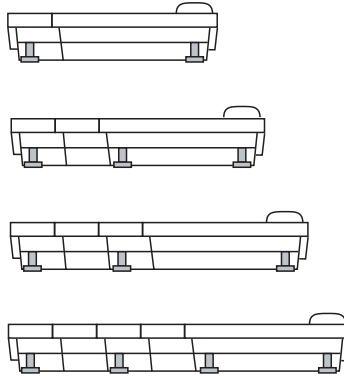

Install card

Use the DCM (Designation Card Manager) to make and print your own key panel designation cards. DCM is included on the Enterprise Telephone Toolbox CD or it can be downloaded from: <http://www.ericsson.com/enterprise/library/manuals.shtml>

For more information, please contact your Ericsson Enterprise certified sales partner.

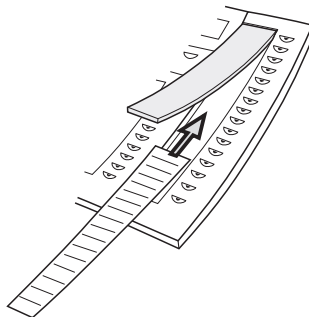

Install pull-out leaf (optional)

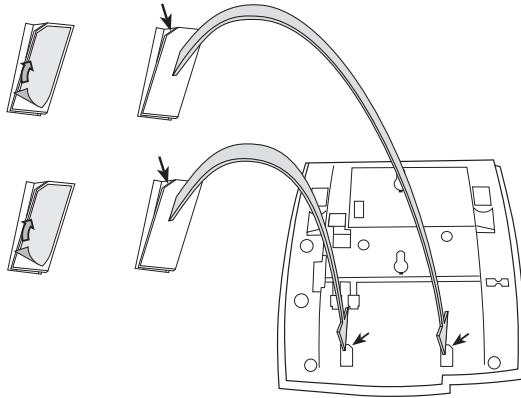

- 1 Remove the protective film from the guiding rails.**
- 2 Attach the guiding rails to the bottom of the phone, observing the direction of the “cut” corner.**

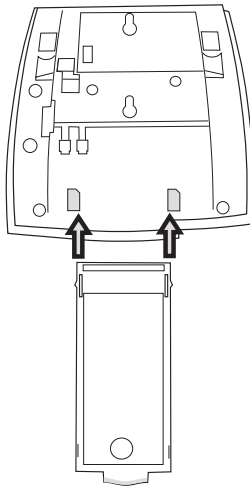

- 3 Insert the pull-out leaf.**

Wall mounting

The phone can be wall mounted without using a special console. Useful for instance in conference rooms or public areas.

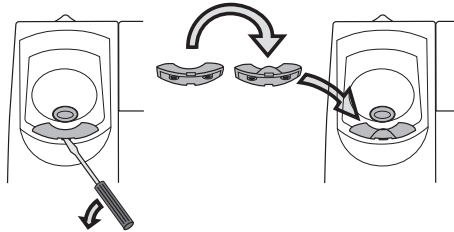

- 1 Use a screwdriver to remove the handset hook.**
- 2 Turn the hook upside down and insert.**

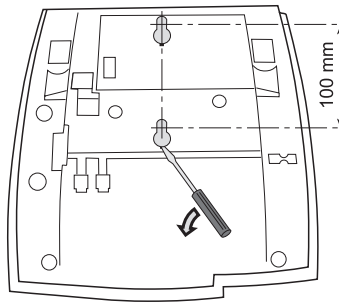

- 3 Use a screwdriver to remove the two plastic covers.**
- 4 Drill wall holes according to measurements given here.**

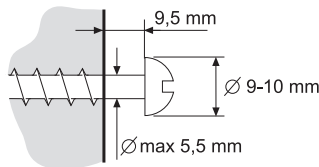

- 5 Place screws according to measurements and mount the phone.**

Placing the phone

Do not expose your phone to direct sunlight for long periods. Keep the phone away from excessive heat and moisture.

Cleaning

Clean your phone only with a soft, water dampened cloth. Using soap or any other cleaning materials may discolor or damage the phone.

Troubleshooting

If your phone is out of order, you can initiate a telephone self-test to check whether there is a fault in the phone or in the system. You can also separately check the firmware revision state of your phone.

To initiate a telephone self-test

Dialog 4223 Professional:

PhoneSet

Press (see display).

If PhoneSet is not shown, press more... until it appears.

Select

Press (see display).

Down or Up

Press to frame Local Test Mode (see display).

Select

Press (see display).

The display shows the firmware revision state and Selftest OK for a few seconds. If there is something wrong, a fault message appears. Inform your system administrator about the fault message.

All the key lamps on the phone and connected extra key panels should be switched on during the self-test to indicate that each key lamp is OK.

After a few seconds the display is checked (the display is completely dark). The display is OK when there are no light dot(s) or line(s). The light frame around the display should be there.

Exit

Press the left most display Menu key to exit (see display).

(However the text is not visible when the display has turned black, the exit feature is still on that Menu key).

Note: *If you do not press Exit, the self-test is automatically finished after about 30 seconds.*

 Down or Up
 Select

Dialog 4225 Vision:

Select PhoneSet in the top menu (see display).

Press to frame Local Test Mode (see display).

Press (see display).

The display shows the firmware revision state and `Selftest OK` for a few seconds. If there is something wrong, a fault message appears. Inform your system administrator about the fault message.

All the key lamps on the phone and connected extra key panels should be switched on during the self-test to indicate that each key lamp is OK.

After a few seconds the display is checked (the display is completely dark). The display is OK when there are no light dot(s) or line(s). The light frame around the display should be there.

Exit

Press the left most display Menu key to exit (see display).

(However the text is not visible when the display has turned black, the exit feature is still on that Menu key).

Note: *If you do not press Exit, the self-test is automatically finished after about 30 seconds.*

To check the firmware revision state

When your system administrator asks for the firmware revision state of your phone:

Dialog 4223 Professional:

PhoneSet

Press (see display).

If PhoneSet is not shown, press more... until it appears.

Select

Press (see display).

Down or Up

Press to frame Firmware Indication (see display).

Select

Press (see display).

The display shows the firmware revision state for your phone.

Exit

Press to exit (see display).

Note: If you do not press Exit, the check is automatically finished after about 30 seconds.

Dialog 4225 Vision:



Select PhoneSet in the top menu (see display).

Down or Up

Press to frame Firmware Indication (see display).

Select

Press (see display).

The display shows the firmware revision state for your phone.

Exit

Press to exit (see display).

Note: If you do not press Exit, the check is automatically finished after about 30 seconds.

Glossary

<i>Additional lines</i>	One or more additional extension numbers can be assigned to your phone, these are programmed on free function keys.
<i>Traffic state</i>	The different states your phone is in; calling, ringing, diverted, etc.
<i>Exchange</i>	Switch. Your telephone switching system.
<i>Idle mode</i>	The state your phone is in when nothing is activated; not calling, not ringing, not diverted etc.
<i>Speed Dialing number</i>	Abbreviated number or short number, used for making frequently used numbers faster to dial.
<i>Supervision</i>	Your extension number can be represented on a function key on other extensions (two or more).
<i>Triple Access Line</i>	A collective name for Line 1, Line 2 and Inquiry lines. Line 1 and Line 2 forms your extension number and are available both for incoming and outgoing calls. Inquiry can only be used for outgoing calls.

Index

A

- Accessories 117
 - Extra handset 121
 - Headset 118
 - Key panel 117
 - Option unit 122
 - Pull-out leaf 121
- Account Code 89
- Additional Directory Number 93
- Answer calls 29
- Authority 49
- Authorization Code, common 49
- Authorization Code, individual 50

B

- Bypass 43

C

- Call Duration (Timer) 60
- Call Forwarding 62
 - Diversion 62
 - External Follow-me 68
 - Internal Follow-me 66
 - Personal Number 69
- Call list 96
- Call metering 59
- Call Waiting 42
- Callback 40
- Common Bell Group 85
- Common Speed Dialing numbers 44
- Conference 55
- Copyright 5
- Cost information 59

D

- D4 mode information 9
- Data privacy 49
- Declaration of conformity 5, 9

Description 7

- D4 mode information 9
- Dialog 4223 Professional 7
- Dialog 4225 Vision 10
- Display information 16
- Display language 27
- Display menu keys 24
- Lamp indications 13
- Tones and signals 14
- Dial by a function key 45
- Dial by Phonebook 45
- Dialing during a connected call 58
- DISA = Direct Inward System Access 95
- Display backlight 116
- Display contrast 115
- Display information 16
- Display menu keys 24
- Disposal of the product 6
- Diversion 62
- Do Not Disturb, DND 32
- DTMF signals 58
- During calls 52
 - Conference 55
 - Dialing during a connected call 58
 - Group Listening (loudspeaking) 52
 - Handsfree 53
 - Handsfree to loudspeaking 52
 - Hold 56
 - Inquiry 53
 - Loudspeaking to handsfree 52
 - Microphone on or off 53
 - Send caller's Identity Code 57
 - Transfer 54

E

- Emergency mode 92
- External Follow-me 68
- Extra handset 121

F

Features and required data 100
 Free on 2nd access 31
 Free Seating 28

G

General Deactivation 91
 Glossary 135
 Group Call-pick-up 85
 Group Do Not Disturb 88
 Group features 85
 Group Hunting 86
 Group Listening (loudspeaking) 52

H

Handset and loudspeaker volume 105
 Handsfree 53
 Headset 118
 Hold 56
 Hot Line 92

I

Immediate Speech Connection 90
 Important user information 6
 Incoming calls 29

- Answer a second call 31
- Do Not Disturb, DND 32
- Handsfree 29
- On another extension 30
- On any other line key 29
- On Line 1 29
- Parallel Ringing 33

 Individual External Line 37
 Individual Speed Dialing numbers 44
 Inquiry 53
 Installation 124
 Internal Follow-me 66
 Internal messages 79
 Intrusion 42

K

Key panel 117

L

Lamp indications 13
 Language 27
 Last External Number Redial 39

M

Mailbox 84
 Make calls 35
 Malicious Call Tracing 94
 Manual Message Waiting (MMW) 79
 Melody Ringing 109
 Message Waiting 81
 Messages 79

- Manual Message Waiting (MMW) 79
- Message Waiting 81
- Voice Mail 82

 Multiple Represented Directory Number 94
 Mute 53
 Mute ring signal 108

N

Night Service 91
 Number Presentation Restriction 36

O

Option unit 122
 Other useful features 89
 Outgoing calls 35

- Authority 49
- Bypass 43
- Call Waiting 42
- Callback 40
- External calls 35
- Handsfree 36
- Individual External Line 37
- Internal calls 35
- Intrusion 42
- Last External Number Redial 39
- Number Presentation Restriction 36
- Redial calls from the Call list 37
- Save external number 39
- Speed Dialing 44
- When you receive a busy tone 40

P

Parallel Ringing 33
 Personal Number 69
 Programming of function keys 98
 Programming of ring signal tone character 104
 Programming of ring signals 102
 Pull-out leaf 121
 Put a call on hold 56

R

Redial calls from the Call list 37

Redial number 39
Refer Back 54
Ring signal volume 108
Ring signals 15

S

Safety instructions 6
Save external number 39
Send Caller Identity Code at transfer 57
Setting form for search profiles 75
Settings 98
 Display backlight 116
 Display contrast 115
 Features and required data 100
 Handset and loudspeaker volume 105
 Melody Ringing 109
 Mute ring signal 108
 Programming of function keys 98
 Programming of ring signal tone character 104
 Programming of ring signals 102

 Ring signal volume 108
 Silent Ringing 108
Short numbers 44
Silent Ringing 108
Speed Dialing 44

T

Timer 60
Tones and signals 14
Transfer 54
Troubleshooting 132

V

Voice Mail 82
Volume 105

W

Warranty 5
Welcome 4
When you receive a busy tone 40

Ericsson is shaping the future of Mobile and Broadband Internet communications through its continuous technology leadership. Providing innovative solutions in more than 140 countries, Ericsson is helping to create the most powerful communication companies in the world.

Ericsson AB
All rights reserved.
For questions regarding the product,
please contact your Ericsson Enterprise Certified Sales Partner.
Also visit us on <http://www.ericsson.com/enterprise>

© Ericsson AB 2007
EN/LZT 103 68 R5A

Printed on chlorine free paper.