



tecdesk
Fixed Wireless Phones



Tecdesk 3500 User Manual

tecdesk.com | English







CONTENTS

INTRODUCTION	4
PACKAGE CONTENTS	5
GETTING TO KNOW YOUR PHONE	6
BUTTON FUNCTIONS	11
STATUS ICONS	14
ALPHANUMERIC KEYPAD	15
CALL FUNCTIONS	16
MENU TREE	19
CONTACTS	20
MESSAGES	23
SETTINGS	26
TROUBLESHOOTING	28
LEGAL INFORMATION	30
HEALTH AND SAFETY	32
DECLARATION OF CONFORMITY	34





INTRODUCTION

Thank you for purchasing the Tecdesk 3500 3G Desk Phone. This phone is designed for use with GSM 900/1800 and UMTS 900/2100MHz networks. You will require a valid SIM card from your network operator. Please refer to your network operator for more information.

Safety Instructions

Please read the following instructions carefully before starting to use the Tecdesk 3500 3G Desk Phone.

- Always read the safety instructions carefully.
- Keep this user manual for future reference.
- Keep the phone away from humidity.
- Place the phone on a reliable flat surface before setting it up.
- If any of the following situations arise, have the unit checked by a service technician:
 - Exposure to moisture.
 - Droppage and damage.
 - Obvious signs of breakage.
- Do not place the phone in a damp room at a distance of less than 1.5m from a water source. Keep water away from the device.
- Do not use the device in environments where there are risks of explosions.
- Maintain the FWP in an environmentally friendly manner.



PACKAGE CONTENTS

Please check the box includes the following components. If there are any items missing please contact your supplier.

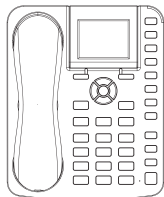

A. Tecdesk 3500

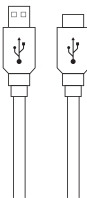

B. USB data cable

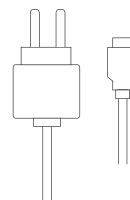

C. AC/DC power adaptor

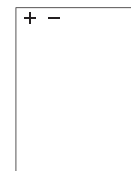

D. Lithium-polymer rechargeable battery

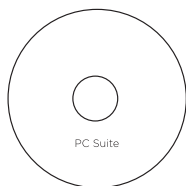

E. PC suite

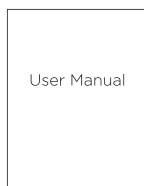

F. User manual





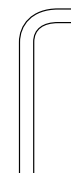







G. Quick start-up guide



H. Allen key



GETTING TO KNOW YOUR PHONE

- | | | |
|--|---|--|
| 1. Handset/ Receiver | 11. LCD screen | 21. [] Loudspeaker button |
| 2. [] OK/ Centre button | 12. Right soft button | 22. Security slot |
| 3. [] Left directional button | 13. M1 - M8 Memory buttons | 23. Wall mount |
| 4. [] Dial button | 14. [] Up directional / Volume + button | 24. Screw for battery cover |
| 5. Alphanumeric keypad | 15. [] Right directional button | 25. Battery compartment cover |
| 6. Jack for receiver cable | 16. [] Down directional/ Volume - button | 26. Power adaptor/Charging port |
| 7. [] Cancel button | 17. [] Power ON/OFF/End button | 27. 3.5mm audio socket |
| 8. [] Headset button | 18. Hold button | 28. Micro USB data cable port |
| 9. [] Mute button | 19. Transfer button | 29. Aluminium stand |
| 10. Left soft button | 20. Conference button | 30. RJ11 port |

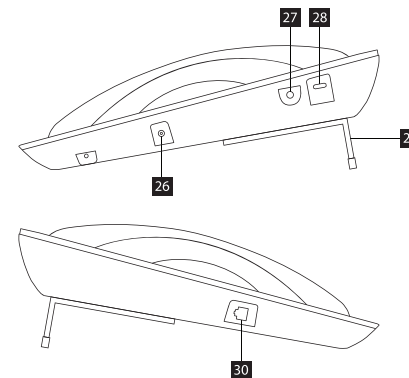
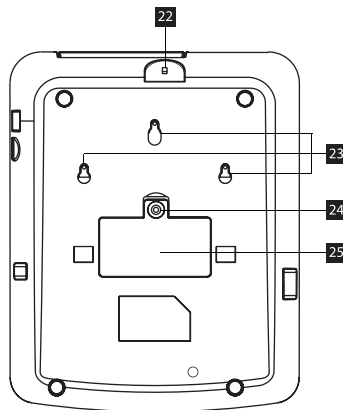
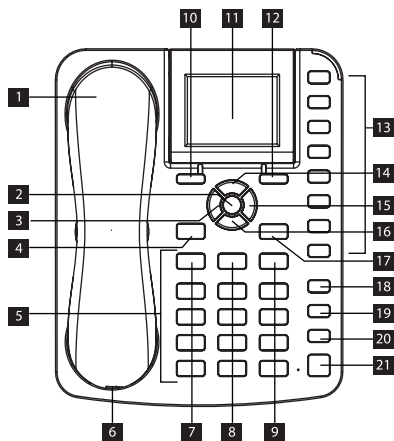



LCD Screen

1. Battery indicator
2. Time
3. Signal strength
4. Network
5. Menu shortcut
6. Contacts shortcut



Installation

Follow the steps below to install the TD3500 Desk Phone.

1. Remove the battery cover with the Allen key, then remove the battery and insert an appropriate SIM card into the device.

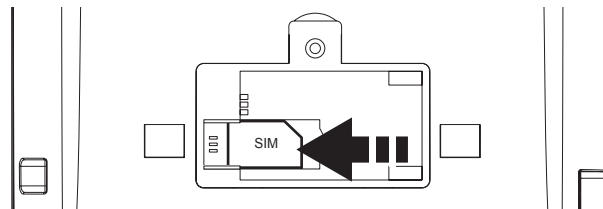
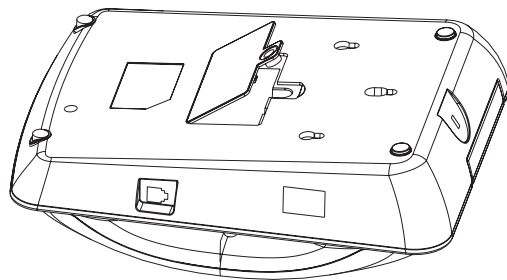



2. Insert the battery into the battery compartment, ensuring the polarity on the battery matches the polarity of the connectors and the cover is re-positioned correctly and secured into place.

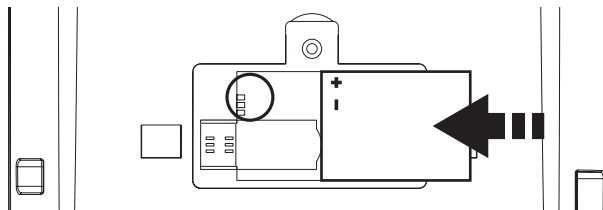

3. Insert the aluminium stand in position.

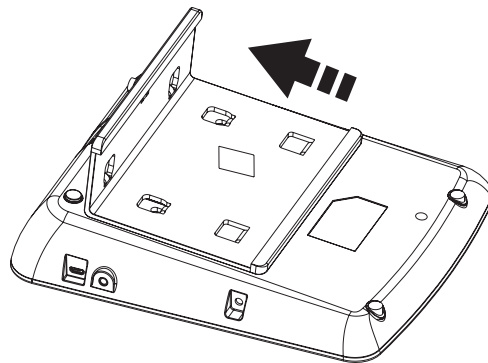



4. Connect the receiver to the device with the curly cord.
5. Connect one end of the power adaptor to the phone's power adaptor/ charging port.
6. Plug the power adaptor into an AC power outlet. The battery level indicator will stop moving once the device is fully charged.

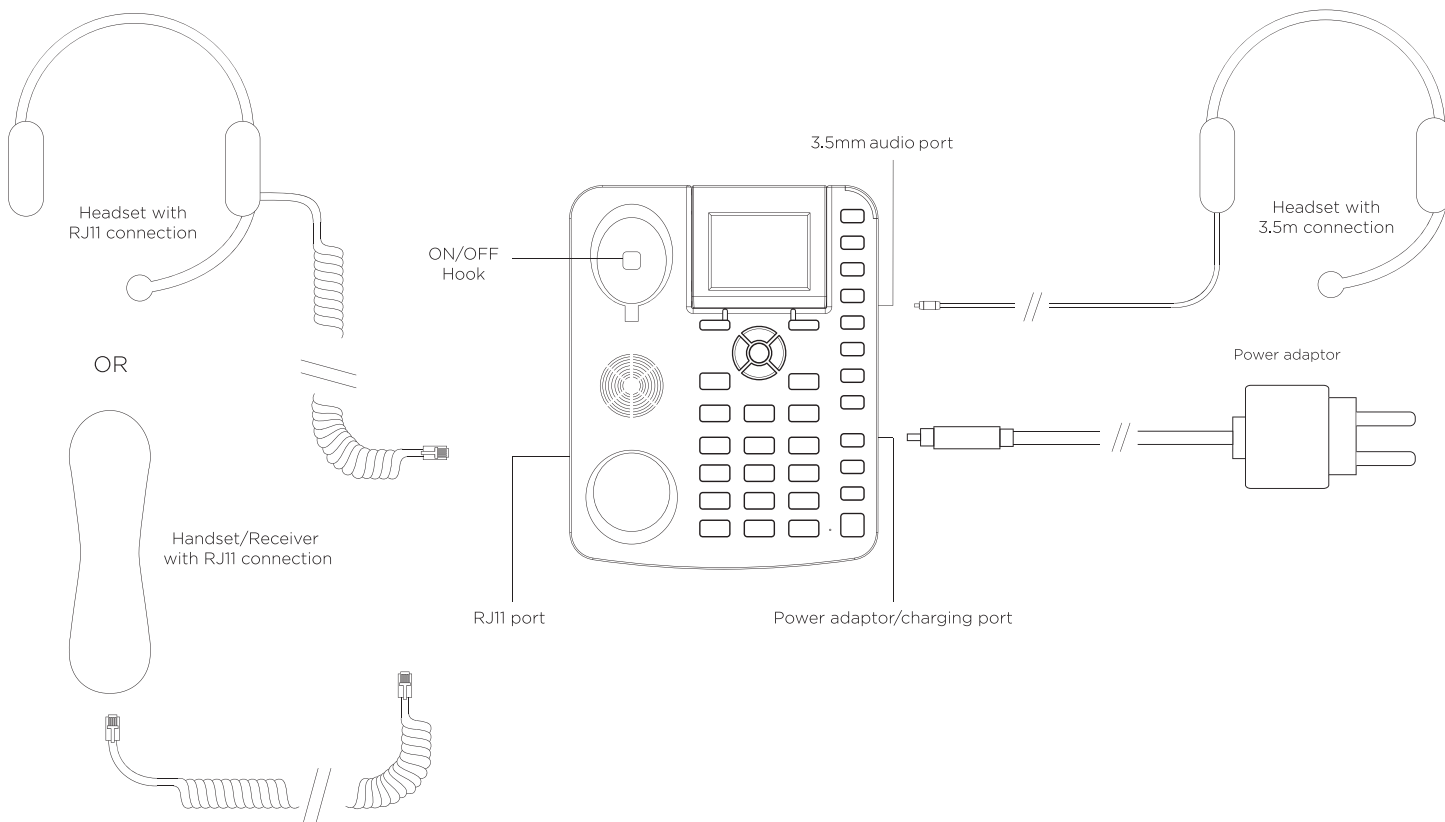





Charging the battery

When the battery level is low, there will be a warning tone; a low battery message will be displayed and the empty battery icon will flash. Plug the power adaptor into the device to begin charging. The battery level indicator will flash during charging mode and once it is fully charged, the full battery icon will appear. Charging a completely flat battery may take 2 to 3 hours.

Powering ON/OFF

Press the [] **button** for 3 seconds and the phone will turn ON. If required, insert a PIN code and press the [**OK**] **button** to confirm. The backlight will illuminate and automatically search for a network operator. When the operator name is shown on the screen, the phone is now in Standby mode and is ready to be used. To turn OFF the device, press the [] **button** for 3 seconds.



Note: If the power source and battery is connected to the device and there is no SIM card inserted in the device the LCD will display “no SIM card”.

If the SIM card is damaged or your network is not authorised to be used on the device the LCD will display “PLEASE INSERT USIM Card. For further information please contact your network operator. Always ensure the device is switched OFF before removing the SIM card. This will prevent damage to the SIM card and data loss. Do not place the SIM card near any electromagnetic surfaces or environments and avoid touching the metal connectors on the SIM card. For further information please contact your network operator.





BUTTON FUNCTIONS

Button	Functions
Left soft button	Corresponds to the function shown by an icon on the lower left hand corner of the LCD screen. In Standby mode, press to enter into the Main menu .
Right soft button	Corresponds to the function shown by an icon on the lower right hand corner of the LCD screen. In Standby mode, press to enter into the Contacts menu .
Dial button []	In Standby mode, press to bring up a list of previously dialed calls. Can be used to dial an outgoing call or answer an incoming call.
Power ON/OFF/End button []	When the phone is powered OFF, press for 3 seconds to turn ON the phone. When the phone is powered ON, press for 3 seconds to turn OFF the phone. During an active call, press to terminate a call. When navigating the menu interface, pressing will return the phone back to Standby mode.
OK/ Centre button [OK]	In Standby mode, press to enter into the main menu. Can also be used to confirm operations when accessing the menu or submenu.
Up directional button [▲]	In standby mode press to enter into the Call Log menu. During an incoming call, press to increase the ringer volume.
Down directional button [▼]	In Standby mode press to enter into the My Stuff menu. During an incoming call, press [▼] button to decrease the ringer volume.



Button	Function
Left directional button [◀]	In Standby mode press to enter into the SMS menu. During an active call press to decrease the volume on the handset or speaker.
Right directional button [▶]	In Standby mode press to enter into the Profiles menu. During an active call, press to increase the volume on the handset or speaker.
Cancel button [C]	Pressing will delete an incorrect input number entry or text, when typing into the dial pad.
Headset button [📞]	Connect the headset and press to transfer the call from receiver to headset mode.
Silence mode button [📞]	Press during an active call to mute/silent your outgoing sound.
Speed dial button [M1 - M8]	Press for the Speed dial functions. Please refer to the “Speed dialing” section of the manual for further information.
Hold button	During an active call, press to switch between caller 1 and caller 2. During an active call, you can make another call. Press to put caller 1 on hold and dial the number of caller 2.
Transfer button	During 2 active calls, one active and other on hold, press to make a transfer between both calls. Can make a “Blind Transfer”, pressing when you are making a second call.















Button	Function
Conference button	Can make Conference call from your phone. During a call with 2 or more callers.
Handsfree button []	During an active call, press to enable or disable the speakerphone.





STATUS ICONS

	Network signal
	Battery indicator
	Text message notification icon
	Call in progress
	Missed call notification
	Phone is connected to a computer via a USB cable
	Alarm enabled notification
	Phone is on silent with the exception of media and alarms function
	Profile status: General
	Profile status: Meeting
	Headset connected
	Keypad locked



ALPHANUMERIC KEYPAD

Refer to the table below when using the alphanumeric keypad. When entering usernames or passwords, you can press the button to toggle between numbers (123), lowercase (abc) characters, and uppercase (ABC) characters.

Button	Lowercase (abc)	Uppercase (ABC)
1	.,?!- _@ 1	.,?!- _@ 1
2	abc2	ABC2
3	def3	DEF3
4	ghi4	GHI4
5	jkl5	JKL5
6	mnoñ6	MNOÑ6
7	pqrs7	PQRS7
8	tuv8	TUV8
9	wxyz9	WXYZ9
0	[SPACE] 0	
#	Toggle between: Numerical/Lowercase/ Uppercase/Predictive text	
*	+ and special chacter selection	





CALL FUNCTIONS



Making a phone call using the alphanumeric keypad

1. In Standby mode, enter the phone number using the alphanumeric keypad, and press the [] **button** to make a call.
2. To end the call, press the **Right soft button** or the [] **button**.

Making a phone call using an external headset via the RJ11 port





1. Connect the headset to the unit via the RJ11 port.
2. Press the [] **button** to enable the headset function.
3. Make the call using the alphanumeric keypad, and press the [] **button**.
4. To end the call, press the [] **button**.

Making a phone call using an external headset via 3.5mm audio socket

1. Connect the headset to the unit via the 3.5mm audio socket.
2. Make the call using the alphanumeric keypad, and press the [] **button**.
3. To end the call, press the the [] **button**.

Note: If two external headsets are connected to the unit, the headset connection via the 3.5mm audio socket will have working priority over the headset connected via the RJ11 port. The ON/OFF hook and loudspeaker function on the unit will be disabled when a headset is connected.

Making a phone call using Contacts

1. In Standby mode, press the **Right soft button** to access the **Contacts** menu.
2. Press the [] [] **buttons** to select the location that the desired contact details are stored in.
3. Press [**OK**] to view the contact.
4. Press the [] **button** to make the call.
5. To end the call press the [] **button** or replace the handset.

Making a phone call using Call Log

1. In Standby mode, press the **Left soft button** to access the **Main menu > Call log**.
2. Use the [] [] **buttons** to access your missed calls, outgoing calls or incoming calls.



3. Select the contact you wish to call, and press the [] **button**.
4. To end the call press the [] **button** or replace the handset.

Making a phone call using Speed Dial

In Standby mode, lift the receiver and press the [**M1 - M8**] **buttons** for the speed dialling feature.

Please ensure the contact numbers are pre-installed into the memory for this feature to work. Please refer to the following for setting up the Speed dialling function.

To set up the Speed Dial button, follow the next steps:

1. In Standby mode, press the **Left soft button** to enter into the **Main menu**.
2. Use the [**▲**] [**▼**] **buttons** to select **Contacts** and press the [**OK**] **button** to access the submenu.
3. Select **Phone** and press the **Left soft button** to access the **Options** menu and select **Settings > Speed dial**.
4. Press the [**OK**] **button** to confirm.
5. Use the [**▲**] [**▼**] **buttons** to shift between the [**M1 - M8**] locations.
6. Press **Set** to confirm your selection and your contact number.
7. Edit the following fields to manage your Speed dialling functions.

Editing

1. Select from [**M1 - M8**] to access your desired contact number.
2. Press the [**OK**] **button**.
3. Use the [**C**] **button** to delete an incorrect entry and use the alphanumeric keypad to edit the contact number.
4. Press the [**OK**] **button** to save the entry.

Remove an entry



1. Select your desired contact number from the [**M1 - M8**] Speed Dial locations.
2. Press the **Left Soft button** to enter into the Options menu.
3. Select **Remove**.
4. Press the [**OK**] **button** to remove the entry.



Remove All

1. Select one of the [**M1 - M8**] Speed Dial buttons.
2. Press the **Left soft button** to enter into the Options menu.
3. Select **Remove ALL**.
4. Press the [**OK**] **button** to remove all the contact numbers stored in the [**M1 - M8**] Speed Dial locations.

Answer or silence an incoming call

1. During an incoming call, press the [] **button** or the **Left soft button** to answer the call.
2. Press the [] **button** to mute an incoming or outgoing call.
3. Press the [] **button** or the **Right soft button** to reject the call.

Adjusting the receiver volume

Press the [] [] **buttons** to increase or decrease the handset volume during an active call.





MENU TREE

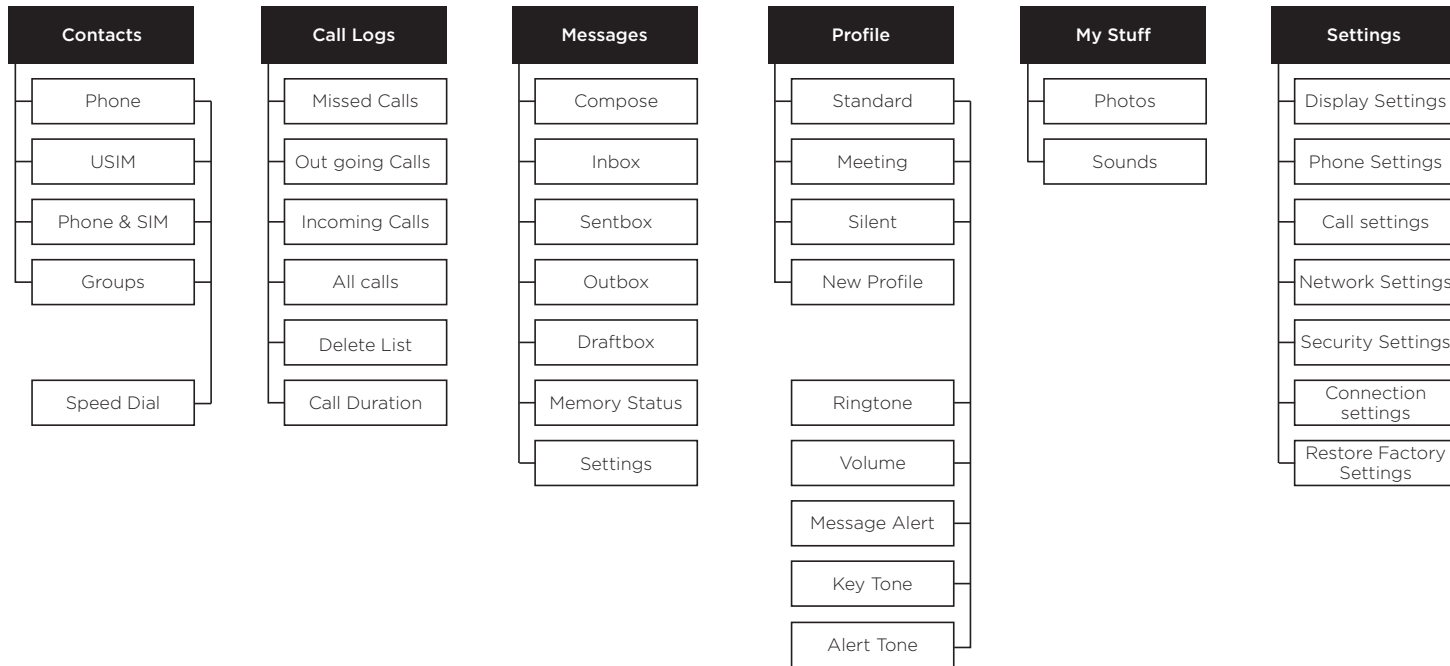



CONTACTS

This section explains how to manage your Contacts.

Creating a New Contact

1. In Standby mode, use the alphanumeric keypad and input a contact number.
2. Press the **Left soft button > Save number**.
3. Input the following categories for the contact.
 - Save:** Use the [◀] [▶] **buttons** to select save to **Phone** or **SIM**.
 - Name:** Use the alphanumeric keypad to input the name of the contact.
 - Number:** Use the alphanumeric keypad to edit the contact number.
 - Email:** Use the alphanumeric keypad to input the email address (optional).
 - Group:** Use the [◀] [▶] **buttons** to select the desired group you want to insert the contact in.
 - Ringtone:** Choose a ringtone to assign to the contact from **Profile** or **My Stuff** using the [▲] [▼] **buttons**.
 - Image:** Choose an image for the contact from **Preset Images** or **My Stuff** using the [▲] [▼] **buttons**.
4. Press **Save** to confirm the entry.

Creating a New Contact from the Call Log

1. In Standby mode, press the **Left soft button** to access the **Main menu > Call log**.
2. Press the [▲] [▼] **button** to access the **Call Log** for your missed calls, outgoing calls, and incoming calls.
3. Select the contact you wish to save to your contact list, and press **Options > Save number > New**.
4. Input the following details for the contact.
 - Save:** Use the [◀] [▶] **button** to select save to **Phone** or **SIM**.
 - Name:** Use the alphanumeric keypad to input the name of the contact.
 - Number:** Use the alphanumeric keypad edit the contact number.
 - Email:** Use the alphanumeric keypad to input the email address (optional).
5. Press **Save** to confirm the entry.

Managing your contacts

1. In Standby mode, press the **Left soft button** to access the **Main menu > Contacts**.
2. Press the [▲] [▼] **buttons** to access the submenu.
 - Phone:** Displays the contact list stored in the phone.
 - SIM:** Displays the contact list stored on the SIM card.



Phone & SIM: Displays the contact list stored in the **Phone** and **SIM**.
Groups: Displays the list of contacts by **Group**.

3. Select the desired contact from the submenu and press **Options** to edit the following to manage your contacts.
Call: Select a contact to make a call.
Send message: Compose a text message to send to the contact.
New: Add a new contact.
Edit: Edit details of the current contact.
Delete: Delete the current contact or delete a contact from the contact list.
Copy: Copy the contacts between the **SIM** and **Phone**.
Add to group: Add the contact to a **Group** (Only contacts saved into the Phone memory can be added to a group).
Send: Send the current contact information by SMS/MMS.
Memory Status: Displays the memory capacity remaining of your Phone contacts and SIM card.
Settings: Set up your contacts. See the following points "Managing your Contacts settings".

Managing your Contacts settings

To access to the Contacts setting, press the **Left soft button** to access the **Main menu > Contacts**. Then select a contact and press **Options > Settings**:

- My business card:** Presets your own contact information.
- Speed dial:** Assigns a Speed Dial number for your most frequently called contact numbers.
- Black list:** Save the contact number in the blacklist. The phone will reject the incoming call from this number.
- Fixed dial:** Activates the fixed dial and save the contact number. Can only be dialled out from the saved contacts as Fixed dial. To active this function, the PIN2 code of your SIM card will be requested. Please contact your network operator for more information.
- Own number:** Displays the number on the SIM card.
- Service dial number:** Can make calls to the main services number of your network operator.

Managing your Group settings

You can add members into Groups from the Contact List. You can also send messages, make calls or allocate an incoming call ringer for a specific Group.

1. In the Standby mode, press the **Left soft button** to access the **Main menu > Contacts**.
2. Press the [▲] [▼] **buttons** to access the Group submenu.
3. Edit the following settings to manage your Groups:
Edit: Edit details such as group name, group ring tone or group OSD.
New: Add new group.
Delete: Delete the current selected group.



Call logs

Use this menu to view the information on the calls you have made, received, or missed.

1. In Standby mode, press the **Left soft button** to access the **Main menu > Call Log**.
2. Press the [▲] [▼] **buttons** to access your missed calls, outgoing calls, and incoming calls.
 - Missed calls:** This menu displays the most recent calls you have missed.
 - Outgoing calls:** This menu displays the most recent calls you have dialed.
 - Incoming calls:** This menu displays the most recent calls you have received.
 - All calls:** This menu displays all **Call Logs** including missed calls, outgoing calls, and incoming calls.
 - Delete list:** Deletes the list of all calls.
 - Call duration:** This menu displays the duration of the last call, all dialed calls, and all answered calls.
3. Select the contact you wish to manage and press **Options** to display a list of functions to perform:
 - Voice call:** Make a voice call to the contact.
 - Edit & Then Dial:** Display the contact number and you can edit and call details.
 - Send message:** Send a text message to the contact.
 - Delete:** Delete the selected log folder or delete the list of Call Logs in batches.
 - Save number:** Adds the contact information to **Contacts**.
 - Set speed dial:** Sets the selected number as a Speed Dial number.
 - Set reject call:** Sets the select contact number to automatically reject the call.





MESSAGES

The Tecdesk 3500 supports Text messages and Voice mail. This section explains how to send and receive messages, and other features associated with messaging.

Creating and Sending Messages

1. In Standby mode, press the **Left soft button** to access the **Main menu > Messages**.
2. Press the **Left soft button** and use the [▲] [▼] **buttons** to access the submenu.
3. Select **Compose** and create your message using the keypad.
4. Select **Option > Send** and input the recipient(s) contact number(s).
5. Edit the following options for your text message:
 - Send:** Send the created message.
 - Insert:** Insert templates, contact numbers in the current message.
 - Save to draft:** Save the message in the draftbox.
 - Input mode:** Select to change the input mode.
 - Insert symbol:** Select to insert a symbol into the message.
 - Input settings:** Select to define the text input method for composing your message.
6. Press **Option > Send** to send the message.

Inbox

Reading text messages

1. In Standby mode, press the **Left soft button** to access the **Main menu > Messages**.
2. Press the **Left soft button** and use the [▲] [▼] **buttons** to access the submenu.
3. Select **Inbox** to view your list of messages.
4. In the Options menu, edit the following submenu to manage the text messages in your Inbox:
 - Reply:** Reply to a current text message.
 - Forward:** Forward the current message. The editing interface contains the original message.
 - Delete:** Delete the currently selected message.
 - Delete all:** Delete all the messages in the inbox.
 - Call:** Make a voice call or video call to the addressed number.
 - View mode:** Display the received messages list according to date or subject.
 - Details:** Display the details of the current message.



Sentbox

View all sent messages.

1. In Standby mode, press the **Left soft button** to access the **Main menu > Messages**.
2. Press the **Left soft button** and use the [▲] [▼] **buttons** to access the submenu.
3. Select **Sentbox** to view your list of message.
4. In the Options menu, edit the following submenu to manage your text messages in the Sentbox.

Forward: Forward the sent message to other contacts.

Delete: Delete the currently selected message.

Delete all: Delete all the messages in the Sentbox.

Call: Make a voice call or video call to the addressed number.

View mode: Display the received messages list according to date or subject.

Details: Display the text message details.

Outbox

Viewing all sent messages.

1. In Standby mode, press **Left soft button** to access the **Main Menu > Messages > Outbox**.
2. In the **Options** menu, edit the following submenu to manage your text messages in the Outbox.

Resend: Resends the selected message.

Delete: Delete the currently selected message.

Delete all: Deletes all the messages in the Outbox.

View mode: Displays the received message list according to date or subject.

Details: Display the text message details.

Draftbox

Viewing or editing your message in Drafts

1. In Standby mode, press the **Left soft button** to access the **Main menu > Messages**.
2. Press the **Left soft button** and use the [▲] [▼] **buttons** to access the submenu.
3. Select **Draftbox** to view your list of messages.
4. In the Options menu, edit the following submenu to manage your text messages in the Drafts.

Send: if no recipient number is listed, it will go to the interface to select or edit the recipient number. If the message content is empty, it confirms whether or not you want to send an empty message.

Delete: Deletes the currently selected message.

Delete all: Deletes all the messages in Drafts.

View mode: Displays the received messages list according to date or subject.

Details: Displays the text message details.



Memory status

Displays the memory status of message entries stored on the Phone and SIM card.

1. In Standby mode, press the **Left Soft button** to access **Main menu > Messages**.
2. Press the **Left soft button** and use the [▲] [▼] **buttons** to access the submenu.
3. Select **memory status** to view the storage capacity on your phone or SIM card.

Managing your text message and voice mail settings

1. In Standby mode, press the **Left soft button** to access the **Main Menu > Messages > Settings**.
2. Edit the following fields for your text message settings:

Settings: Sets up the service centre of messaging.

Send settings: Sets up information with regards to sending messages.

Default storage: Selects the default location to store your messages.

Optimisation: When you activate this function, it will change the input letter from USC2 to SMS 7 bit. It does not support UCS2 characters.

Voice mail number: Stores the phone number of your voice mailbox within this menu. In the voice mailbox, callers can leave messages that you can listen to. For details contact your network operator for more information.

Profile

You can set up, customise and store different user profiles on the phone.

1. In Standby mode, press the **Left soft button** to access the **Main menu > Profile**.
2. Use the [▲] [▼] **buttons** to select from the submenu: **Standard, Meeting, Silence, New profile**.
3. Press the [OK] **button** to enter into the submenus and edit the following fields to customise each profile.

Voice Call Ringtone: Select a ringtone from the pre-set list or personalise your ringtone from the **My Stuff** folder.

Volume: Adjusts the volume of the ringtone.

Message alert: Select a message notification alert from the pre-set list or personalise your ringtone from the **My Stuff** folder.

Key tone: Enables or disables the key tone.

Warning tone: Enables or disables the warning tone.

My stuff

In the **My Stuff** menu you can manage your images or audio files.

1. In Standby mode, press the **Left soft button** to access the **Main menu > My Stuff**.
2. Use the [▲] [▼] **buttons** to access the submenu; **Images** or **Sounds**.
3. Press the [OK] **button** to enter into the submenus and edit the following fields to set your preferences:

Photos: Set the default wallpaper for your LCD screen.

Audio Music: Store your music files in this location.

Ring: Store your ringtone files in this location.



SETTINGS

1. In Standby mode, press the **Left soft button** to access the **Main menu > Settings**.
2. Press the **Left soft button** and use the [▲] [▼] **buttons** to access the submenu.
3. Edit the following submenu to define your settings.

Display settings

Home Screen: Sets up standby menu for your phone. It includes wallpaper and whether to display the time and date.

Backlight time: Sets up the waiting time of screen light, including 5 seconds/10 seconds/20 seconds or Always.

Brightness: Adjusts the contrast of the display for the varying lighting conditions.

Phone settings

Language: Select a default language for your phone.

Time and date: Defines the time, date, time format, date format and summer time.

Call settings

My Phone number: Enables or disables the Caller ID function to display your phone number to the person you are calling. This must be supported by your network operator. Please contact your network operator for more information.

Call waiting: Active to be notified of a new incoming call while you have a call in progress or switch between the two calls. This must be supported by your network operator. For more details please contact your network operator.

Answer mode: Allows you to press any button to answer a call.

Auto redial: Enables or disables the auto redial function. If your call fails to connect, your phone will attempt to redial 10 times.

Minute prompt: Enables or disables a notification alert 10 seconds before the next full minute is approaching during a call.

Answer prompt: Enables or disables a notification alert when the call is put through.

Call divert: Diverts an incoming voice call/video call to another number you assigned or your voicemail/videomail.

Call barring: Sets the limits on making and answering calls. This must be supported by your network. For details contact your network operator for more information.

Network settings

Define the connection of your phone to a network.

Network Selection: Select your network connection. The phone supports Auto/GSM/WCDMA modes.

Search: Allows you to set Auto or Manual mode to search for a network connection.

Preferred network: Set up to connect to a network from the network list.



Security settings

This options allows to set up passwords to lock your phone and SIM card to avoid unauthorised use.

Phone lock: Allows to lock your phone once the backlight of the screen dims and the phone is in Standby mode. The default lock code is "0000".

PIN lock: Enables or disables the PIN code for your SIM card. This PIN code will be provided by your network operator. Please contact your network operator for more information.

Change phone lock code: Change your phone lock code.

Change PIN: Change your PIN code.

Change PIN2: Change your PIN2 code.

Connection Settings

The PC suite enables you to manage your phone through your PC. You can quickly input messages on your PC and send out via your phone. You can also backup and restore contacts, calendars and messages on your PC, and manage your phone calls.

The PC suite will provide you a step by step guide to perform the following.

- Install and uninstall the PC suite.
- Connect your phone with a computer.
- Import and export contacts, calendars or messages on your computer.
- Manage the messages on your phone.
- Edit and send Messages.
- Manage the contacts on your phone and SIM card.
- Manage the calendars on your phone and SIM card.
- Manage the multimedia files on your phone and PC.
- Auto and smart sync your phone with Outlook or Outlook Express, Lotus Notes and so on.
- Backup and restore the contacts, calendars or multimedia files on your computer.
- Dialup and connect to the internet via your mobile phone.

Restore Factory Settings

To restore the factory setting on your phone you will require the PIN code.

Restore specific: Resets specific settings only.

Reset all: Resets the phone to the original factory settings. All data will be deleted.



TROUBLESHOOTING

Please perform the simple checks in this section below before contacting a service professional.

Your phone cannot be switched ON

- Be sure that you pressed and held the [] **button** for more than 3 seconds.
- Check that the battery is properly connected to your phone. Remove the battery, reinstall the battery, and restart your phone.
- If the power is exhausted, recharge the battery.

The following messages may appear when you power ON your phone.

Enter the phone lock code: The automatic phone lock function has been enabled. You must enter the phone lock code before you can use the phone.

Enter the PIN code: The PIN lock feature is enabled. Every time the phone is switched ON, the PIN has to be entered. (If you are using your phone for the first time, you must enter the PIN code supplied with the SIM card).

Enter the PUK code: The PIN code has been entered incorrectly three times, and the SIM card is now blocked. Enter the PUK code supplied by your network operator.

USIM card error

- Clean the metal contact on the SIM card with a clean cloth. (Do not use any solvents)
- The SIM card is not properly inserted. Install the SIM card according to the user manual.
- The SIM card is damaged. Contact your network operator.

Network failure

- You may be in a weak signal area. Move to a better location for a stronger signal.

You are out of network service coverage

- The SIM card is invalid. Contact your network operator.

You have entered a number but it does not dial

- Ensure that you have pressed the dial button.
- Check the call barring settings to ensure the contact number is not disabled.
- Check the fixed dialling setting is disabled.
- Your SIM card is within network coverage.
- Your network operator may be experiencing connection problems.

The quality of your call is poor

- Check the volume.
- You are in a weak signal area, such as near a tall building or in the basement. Move to a location with a better signal strength.
- Your network operator may be experiencing connection problems.



Your correspondent cannot reach you

- Ensure that your phone is switched ON and connected to a network.
- Ensure that your SIM card is not blocked.
- Ensure that your SIM card is within network coverage.
- Check that you have not set incoming call barring.

Your correspondent cannot hear you speaking

- Increase the volume on your handset.
- Ensure that you are holding the phone close enough to the mouth piece.
- Check the handset cable is securely connected to the phone.

The standby duration is too short

- The standby duration is related to the network settings. You may be in a weak signal area. If your phone cannot receive signals, the phone will continue to send a signal to search for a network and consume power. This shortens the standby duration. Use your phone in a stronger signal area or switch it OFF temporarily.

Your battery needs to be changed

- If the battery is damaged or will not charge properly.
- Check the power cable is connected to the unit to ensure the charger reaches the battery efficiently.
- Clean the charging contacts on the phone and on the battery with a clean dry cloth.
- Replace the battery or charger if it appears to be damaged.

If the above guidelines do not help you to solve the problem, take note of the model and serial number of your phone, your warranty details, and a clear description of the problem. Then contact your local after-sales service.



LEGAL INFORMATION

Notice

The information in this manual is subject to change without notice. Whist every care has been taken in the preparation and design of the manual, statements, recommendations and information, implied or expressed, these do not constitute a warranty of any kind. No part of this manual may be reproduced, quoted or translated by any means or in any form photographically, mechanically or electronically, without the written permission of Tecmobile (International) Ltd.

Trademarks and Permissions

The Bluetooth® trademark and logos are owned by the Bluetooth SIG, Google Mail is a trademark of Google Inc.; Wi-Fi, Wi-Fi Protected Access, Wi-Fi Protected setup, and WPA are trademarks of the Wi-Fi Alliance; Microsoft, Hotmail, Outlook, Windows Live, and Windows Media are trademarks of Microsoft Corporation; GSM and Global System for Mobile Communications are trademarks of the GSM MOU Association; JavaScript is a trademark of Oracle America, Inc. All other trademarks are the property of their respective owners and any use of such trademarks by Tecmobile is under license where required.

FCC Notice

This phone complies with part 15 of the FCC Rules. Operation is subject to the following two conditions: (1) This device may not cause harmful interference, and (2) this device must accept any interference received, including interference that may cause undesired operation.

This phone has been tested and found to comply with the limits for a Class B digital device, pursuant to Part 15 of the FCC Rules. These limits are designed to provide reasonable protection against harmful interference in a residential installation. This equipment generates uses and can radiate radio frequency energy and, if not installed and used in accordance with the instructions, may cause harmful interference to radio communications. However, there is no guarantee that interference will not occur in a particular installation. If this equipment does cause harmful interference to radio or television reception, which can be determined by turning the equipment off and on, the user is encouraged to try to correct the interference by one or more of the following measures:

- Re-orientate or relocate the receiving antenna.
- Increase the separation between the equipment and receiver.
- Connect the equipment into an outlet on a circuit different from that to which the receiver is connected.
- Consult the dealer or an experienced radio/TV technician for help.

Changes or modifications not expressly approved by the party responsible for compliance could void the user's authority to operate the equipment. The antenna(s) used for this transmitter must not be co-located or operated in conjunction with any other antenna or transmitter.



Warranty Disclaimers

Although every effort is used to reduce inaccuracies and, except those required by applicable law, no warranties of any kind, either express or implied, and including but not limited to the implied warranties of fitness for a particular use or satisfactory quality, are made in relation to the contents, accuracy or reliability of this manual.

Tecmobile reserves the right to modify, change specifications or information in this manual without any consequential liability or prior notice. Under no circumstances, except as required by applicable law, will Tecmobile or any of its licensors be responsible for indirect damages or consequential loss of income or data however caused.

Disclaimer

Third party content and services may be enabled and are available through this device. Some features and accessories referred to in this manual rely on local network settings and installed software. These may or may not automatically be accepted, in total or in a limited way, by local service and network providers. As a consequence, some descriptions may not match the features or product which you can purchase/download. Third party content and services belong to, are the copyright of, are trademarked by and patented by their respective owners under intellectual property law. They should not be used without the express permission of the service provider or content owner and, unless given specific permission by them, you should not transmit, upload, publish, modify, copy or distribute in any way the services or content displayed through this device. The device may contain technology, software or commodities which are subject to regulations and export laws from the US and other countries. Diversion contrary to law is prohibited. To the fullest extent permissible by applicable law by using the applications provided with your device, you acknowledge that the application is provided “as is”. Tecmobile does not provide a warranty, make any representations, or take any responsibility for the end-user support, content or functionality of third-party applications provided with your device.



HEALTH AND SAFETY

RF/SAR information

Your phone contains a transmitter and receiver. When powered ON it receives and transmits low-level radio-frequency (RF). Country governments all over the world adopt state security guidelines developed by independent scientific organisations such as ICNIRP and IEEE. These guidelines establish permitted levels of RF energy for the general population. The guidelines include a substantial safety margin designed to ensure the safety of all persons, regardless of age and health.

Specific Absorption Rate (SAR) is the unit of measurement for absorbed radio quantity when using mobile devices. SAR tests are conducted using standard operating positions with the phone transmitting at its highest certified power level, however, the actual SAR level of the phone while operating can be well below the maximum value. In general, the closer you are to a base station, the lower the power output of the phone.

The SAR values may vary, depending on different models of phones. To ensure the safety and health of the users, the phone is designed and manufactured to meet the radio exposure guidelines.

The ICNIRP SAR limit for mobiles devices used by the general public is 2W/kg and highest SAR value for this device is tested for use at the ear is below the SAR limit recommended by ICNIRP. WCDMA Band I front side, middle 10g value: 1.22 W/Kg.

Batteries

- Never use a charger or battery that is damaged in any way. Use the battery correctly.
- Do not short-circuit the battery, which may damage it, cause heat or cause fire.
- Do not dispose of batteries in high temperature or in a fire as they may explode. Return the waste battery to the dealer or appointed recycle locations.
- Do not dispose as household waste. Battery charging time depends on the remaining battery charge, the type of battery, and the charger used. The battery can be charged and discharged hundreds of times, but it will gradually wear out.
- When the operation time is noticeably shorter than normal, it is time to replace the battery with a new one.
- Use only original or approved chargers and batteries. Unplug the charger from the electrical plug and the device when not in use.
- Do not over charge as this will damage the battery and shorten its life. Leaving the battery in extremely hot or cold places will reduce the capacity of the battery. Li-ion batteries are particularly affected by temperatures below 0°C.

Operating environment

Remember to follow any special regulations in force in the area you are in, and always switch OFF your phone whenever it is forbidden to use it, or it may cause danger. When connecting the phone or any accessory to another device, read its User's Guide for detailed safety instructions. Do not connect incompatible products. It is recommended that the equipment should only be used in the normal operating position. Do not expose the equipment to temperatures below -10° or above 50°C.



Medical devices

Ensure that you switch OFF your phone in areas near electronic medical equipment that require the phone to be switched OFF: (such as heart pacemakers, hearing aids, etc.).

Most medical devices can shield the phone's RF signal, but some cannot. If you have any doubts, or need to find out more, please consult your doctor or medical device manufacturer.

Pacemakers

Pacemaker manufacturers advise the distance between your phone and heart pacemaker should be at least 6 inches (15.3 cm), otherwise the phone could interfere with the pacemaker.

People fitted with a pacemaker should note the following:

- Always keep a distance (at least 6 inches) between the phone and the pacemaker when the phone is switched ON.
- Listen to the phone using the ear which is furthest from the pacemaker.
- Switch OFF your phone if you feel there is interference, and consult the doctor as soon as possible.

Emergency calls

This phone, like any wireless phone, operates using radio signals, which cannot guarantee connection in all conditions. Therefore, you should never rely solely on any wireless phone for essential communications like medical emergencies. To make or receive calls, the phone must be switched ON and in a service area with adequate signal strength. To make an emergency call, enter the local emergency number in standby mode and press the call button.

Care and maintenance

Your phone is a product of superior design and craftsmanship and should be treated with care. The suggestions below will allow you to enjoy this product for many years.

- Keep your phone away from small children and pets. They may accidentally damage the phone or choke on small parts.
- Keep the phone dry and avoid liquids that corrode the phone. Do not use the phone with wet hands, which may cause an electric shock.
- Do not store the phone in hot areas, which can shorten the life of electronic devices, damage batteries, or melt accessories.
- Do not store the phone in cold areas. When the phone warms up to its normal operating temperature, moisture can build up inside the phone, which may damage the phone's electronic circuit boards.
- Do not expose your phone to hot sunlight which may cause it to over-heat.
- Do not place your phone near flammable liquids, gas or explosive substances.
- Do not drop or knock the phone. Rough handling can break internal circuit boards.
- When cleaning the phone, use a damp or anti-static cloth. Do not use a dry or static cloth.
- Do not use chemicals such as cleaning solvents to clean the surface. Switch OFF the phone first before cleaning.
- Do not paint the phone. Paint can prevent proper operation.
- If the phone or battery gets wet and the label on the phone is damaged, phone repairs are no longer guaranteed by the manufacturer's warranty, even if the warranty for your phone has not expired.



DECLARATION OF CONFORMITY

Hereby, we declare under our sole responsibility that this product and in combination with the accessories are in compliance with the appropriate standards 3GPP TS 51.010-1, EN 301908-1/-2, EN 301511, EN 301489-1/-7/-24, EN 60950-1, EN 50360, following the provisions of, Radio Equipment and Telecommunication Terminal Equipment directive 99/5/EC with requirements covering EMC directive 04/108/EC, and Low Voltage directive 06/95/EC.







tecdesk
tecdesk.com

MODEL NO: TD3500

CE 0700

