

# TP-LINK®

## User Guide

**TD-W8951ND**

**150Mbps Wireless N ADSL2+ Modem Router**



## **COPYRIGHT & TRADEMARKS**

Specifications are subject to change without notice. **TP-LINK®** is a registered trademark of TP-LINK TECHNOLOGIES CO., LTD. Other brands and product names are trademarks or registered trademarks of their respective holders.

No part of the specifications may be reproduced in any form or by any means or used to make any derivative such as translation, transformation, or adaptation without permission from TP-LINK TECHNOLOGIES CO., LTD. Copyright © 2013 TP-LINK TECHNOLOGIES CO., LTD. All rights reserved.

<http://www.tp-link.com>

## **FCC STATEMENT**



This equipment has been tested and found to comply with the limits for a Class B digital device, pursuant to part 15 of the FCC Rules. These limits are designed to provide reasonable protection against harmful interference in a residential installation. This equipment generates, uses and can radiate radio frequency energy and, if not installed and used in accordance with the instructions, may cause harmful interference to radio communications. However, there is no guarantee that interference will not occur in a particular installation. If this equipment does cause harmful interference to radio or television reception, which can be determined by turning the equipment off and on, the user is encouraged to try to correct the interference by one or more of the following measures:

- Reorient or relocate the receiving antenna.
- Increase the separation between the equipment and receiver.
- Connect the equipment into an outlet on a circuit different from that to which the receiver is connected.
- Consult the dealer or an experienced radio/ TV technician for help.

This device complies with part 15 of the FCC Rules. Operation is subject to the following two conditions:

- 1) This device may not cause harmful interference.
- 2) This device must accept any interference received, including interference that may cause undesired operation.

Any changes or modifications not expressly approved by the party responsible for compliance could void the user's authority to operate the equipment.

Note: The manufacturer is not responsible for any radio or TV interference caused by unauthorized modifications to this equipment. Such modifications could void the user's authority to operate the equipment.

## **FCC RF Radiation Exposure Statement**

This equipment complies with FCC RF radiation exposure limits set forth for an uncontrolled environment. This device and its antenna must not be co-located or operating in conjunction with any other antenna or transmitter.

"To comply with FCC RF exposure compliance requirements, this grant is applicable to only Mobile Configurations. The antennas used for this transmitter must be installed to provide a separation distance of at least 20 cm from all persons and must not be co-located or operating in conjunction with any other antenna or transmitter."

## **CE Mark Warning**

# **CE 1588**

This is a class B product. In a domestic environment, this product may cause radio interference, in which case the user may be required to take adequate measures.

## **Canadian Compliance Statement**

This device complies with Industry Canada license-exempt RSS standard(s). Operation is subject to the following two conditions:

- (1) This device may not cause interference, and
- (2) This device must accept any interference, including interference that may cause undesired operation of the device.

Cet appareil est conforme aux norms CNR exemptes de licence d'Industrie Canada. Le fonctionnement est soumis aux deux conditions suivantes:

- (1) cet appareil ne doit pas provoquer d'interférences et
- (2) cet appareil doit accepter toute interférence, y compris celles susceptibles de provoquer un fonctionnement non souhaité de l'appareil.

This device has been designed to operate with the antennas listed below, and having a maximum gain of 5 dBi. Antennas not included in this list or having a gain greater than 5 dBi are strictly prohibited for use with this device. The required antenna impedance is 50 ohms.

To reduce potential radio interference to other users, the antenna type and its gain should be so chosen that the equivalent isotropically radiated power (e.i.r.p.) is not more than that permitted for successful communication.

## **Industry Canada Statement**

Complies with the Canadian ICES-003 Class B specifications.

Cet appareil numérique de la classe B est conforme à la norme NMB-003 du Canada.

This device complies with RSS 210 of Industry Canada. This Class B device meets all the requirements of the Canadian interference-causing equipment regulations.

Cet appareil numérique de la Classe B respecte toutes les exigences du Règlement sur le matériel brouilleur du Canada.

## **Korea Warning Statements**

당해 무선설비는 운용중 전파혼신 가능성이 있음.

## NCC Notice & BSMI Notice

注意！

依據 低功率電波輻射性電機管理辦法

第十二條 經型式認證合格之低功率射頻電機，非經許可，公司、商號或使用者均不得擅自變更頻率、加大功率或變更原設計之特性或功能。

第十四條 低功率射頻電機之使用不得影響飛航安全及干擾合法通行；經發現有干擾現象時，應立即停用，並改善至無干擾時方得繼續使用。前項合法通信，指依電信規定作業之無線電信。低功率射頻電機需忍受合法通信或工業、科學以及醫療用電波輻射性電機設備之干擾。

### 安全諮詢及注意事項

- 請使用原裝電源供應器或只能按照本產品注明的電源類型使用本產品。
- 清潔本產品之前請先拔掉電源線。請勿使用液體、噴霧清潔劑或濕布進行清潔。
- 注意防潮，請勿將水或其他液體潑灑到本產品上。
- 插槽與開口供通風使用，以確保本產品的操作可靠並防止過熱，請勿堵塞或覆蓋開口。
- 請勿將本產品置放於靠近熱源的地方。除非有正常的通風，否則不可放在密閉位置中。
- 請不要私自打開機殼，不要嘗試自行維修本產品，請由授權的專業人士進行此項工作。

## UkrSEPRO



Продукт сертифіковано згідно с правилами системи УкрСЕПРО на відповідність вимогам нормативних документів та вимогам, що передбачені чинними законодавчими актами України.

## Safety Information

- When product has power button, the power button is one of the way to shut off the product; when there is no power button, the only way to completely shut off power is to disconnect the product or the power adapter from the power source.
- Don't disassemble the product, or make repairs yourself. You run the risk of electric shock and voiding the limited warranty. If you need service, please contact us.
- Avoid water and wet locations.

This product can be used in the following countries:

AT	BG	BY	CA	CZ	DE	DK	EE
ES	FI	FR	GB	GR	HU	IE	IT
LT	LV	MT	NL	NO	PL	PT	RO
RU	SE	SK	TR	UA			

## DECLARATION OF CONFORMITY

For the following equipment:

Product Description: **150Mbps Wireless N ADSL2+ Modem Router**

Model No.: **TD-W8951ND**

Trademark: **TP-LINK**

We declare under our own responsibility that the above products satisfy all the technical regulations applicable to the product within the scope of Council Directives:

Directives 1999/5/EC, Directives 2004/108/EC, Directives 2006/95/EC, Directives 1999/519/EC, Directives 2011/65/EU

The above product is in conformity with the following standards or other normative documents

**ETSI EN 300 328 V1.7.1: 2006**

**ETSI EN 301 489-1 V1.9.2:2011& ETSI EN 301 489-17 V2.2.1:2012**

**EN 55022:2010**

**EN 55024:2010**

**EN 61000-3-2:2006+A1:2009+A2:2009**

**EN 61000-3-3:2008**

**EN60950-1:2006+A11; 2009+A1:2010+A12:2011**

**EN62311:2008**

*The product carries the CE Mark:*

**CE 1588**

Person responsible for marking this declaration:



**Yang Hongliang**

**Product Manager of International Business**

Date of issue: 2013

# CONTENTS

<b>Package Contents .....</b>	<b>1</b>
<b>Chapter 1. Introduction .....</b>	<b>2</b>
1.1 Product Overview .....	2
1.2 Main Features .....	2
1.3 Conventions .....	3
<b>Chapter 2. Hardware Installation .....</b>	<b>4</b>
2.1 The Front Panel.....	4
2.2 The Back Panel .....	5
2.3 Installation Environment .....	6
2.4 Connecting the Modem Router.....	7
<b>Chapter 3. Quick Installation Guide .....</b>	<b>9</b>
3.1 Configure PC.....	9
3.2 Login.....	12
<b>Chapter 4. Software Configuration.....</b>	<b>16</b>
4.1 Status .....	16
4.1.1 Device Info .....	16
4.1.2 System Log.....	17
4.1.3 Statistics .....	18
4.2 Quick Start.....	20
4.3 Interface Setup .....	21
4.3.1 Internet.....	21
4.3.2 LAN.....	26
4.3.3 Wireless .....	29
4.4 Advanced Setup .....	40
4.4.1 Firewall .....	40
4.4.2 Routing .....	41
4.4.3 NAT.....	42
4.4.4 QoS.....	46
4.4.5 VLAN .....	48
4.4.6 ADSL .....	51
4.5 Access Management.....	52
4.5.1 ACL.....	52

4.5.2	Filter .....	53
4.5.3	SNMP .....	62
4.5.4	UPnP .....	62
4.5.5	DDNS .....	63
4.5.6	CWMP .....	64
4.6	Maintenance .....	65
4.6.1	Administration .....	65
4.6.2	Time Zone .....	66
4.6.3	Firmware .....	67
4.6.4	SysRestart .....	70
4.6.5	Diagnostics .....	70
4.7	Help .....	71
<b>Appendix A: Specifications .....</b>		<b>73</b>
<b>Appendix B: Troubleshooting .....</b>		<b>74</b>
<b>Appendix C: Technical Support .....</b>		<b>83</b>



## Package Contents

The following contents should be found in your package:

- One TD-W8951ND 150Mbps Wireless N ADSL2+ Modem Router
- One Power Adapter for TD-W8951ND 150Mbps Wireless N ADSL2+ Modem Router
- Quick Installation Guide
- One RJ45 cable
- Two RJ11 cables
- One ADSL splitter
- One Resource CD, which includes this User Guide

 **Note:**

Make sure that the package contains the above items. If any of the listed items are damaged or missing, please contact your distributor.

# Chapter 1. Introduction

Thank you for choosing the **TD-W8951ND 150Mbps Wireless N ADSL2+ Modem Router**.

## 1.1 Product Overview

The device is designed to provide a simple and cost-effective ADSL Internet connection for a private Ethernet or IEEE 802.11n/ IEEE 802.11g/ IEEE 802.11b wireless network.

The TD-W8951ND connects to an Ethernet LAN or computers via standard Ethernet ports. The ADSL connection is made using ordinary telephone line with standard connectors. Multiple workstations can be networked and connected to the Internet using a single Wide Area Network (WAN) interface and single global IP address. The advanced security enhancements, **IP/MAC Filter**, **Application Filter** and **URL Filter** can help to protect your network from potentially devastating intrusions by malicious agents from the outside of your network.

**Quick Start** of the Web-based Utility is supplied and friendly help messages are provided for the configuration. Network and Router management is done through the Web-based Utility which can be accessed through local Ethernet using any web browser.

### ADSL

The TD-W8951ND supports full-rate ADSL2+ connectivity conforming to the ITU and ANSI specifications. In addition to the basic DMT physical layer functions, the ADSL2+ PHY supports dual latency ADSL2+ framing (fast and interleaved) and the I.432 ATM Physical Layer.

### Wireless

In the most attentive wireless security, the modem router provides multiple protection measures. It can be set to turn off the wireless network name (SSID) broadcast so that only stations that have the SSID can be connected. The modem router provides wireless LAN 64/128-bit WEP encryption security, WPA-PSK/WPA2-PSK authentication, as well as TKIP/AES encryption security.

## 1.2 Main Features

- Four 10/100Mbps Auto-Negotiation RJ45 LAN ports (Auto MDI/MDIX), one RJ11 port.
- Provides external splitter.
- Adopts Advanced DMT modulation and demodulation technology.
- Supports bridge mode and Router function.
- Multi-user sharing a high-speed Internet connection.

- Downstream data rates up to 24Mbps, upstream data rates up to 3.5Mbps (With Annex M enabled) .
- Supports long transfers, the max line length can reach to 6.5Km.
- Supports remote configuration and management through SNMP and CWMP.
- Supports PPPoE, it allows connecting the internet on demand and disconnecting from the Internet when idle.
- Provides reliable ESD and surge-protect function with quick response semi-conductive surge protection circuit.
- High speed and asymmetrical data transmit mode, provides safe and exclusive bandwidth.
- Supports All ADSL industrial standards.
- Compatible with all mainstream DSLAM (CO).
- Provides integrated access of internet and route function which face to SOHO user.
- Real-time Configuration and device monitoring.
- Supports Multiple PVC (Permanent Virtual Circuit).
- Built-in DHCP server.
- Built-in firewall, supporting IP/MAC filter, Application filter and URL filter.
- Supports Virtual Server, DMZ host and IP Address Mapping.
- Supports Dynamic DNS, UPnP and Static Routing.
- Supports system log and flow Statistics.
- Supports firmware upgrade and Web management.
- Provides WPA-PSK/WPA2-PSK data security, TKIP/AES encryption security.
- Provides 64/128-bit WEP encryption security and wireless LAN ACL (Access Control List).

### **1.3 Conventions**

The modem router or device mentioned in this User Guide stands for TD-W8951ND without any explanations.

Parameters provided in the pictures are just references for setting up the product, which may differ from the actual situation.

## Chapter 2. Hardware Installation

### 2.1 The Front Panel



Figure 2-1

The LEDs locate on the front panel. They indicate the device's working status. For details, please

#### LED Explanation:

Name	Status	Indication
⏻ (Power)	On	The modem router is powered on.
	Off	The modem router is off. Please ensure that the power adapter is connected correctly.
☎ (ADSL)	On	ADSL line is synchronized and ready to use.
	Flash	The ADSL negotiation is in progress.
	Off	ADSL synchronization fails. Please refer to <a href="#">Note 1</a> for troubleshooting.
🌐 (Internet)	On	The network is available with a successful Internet connection.
	Flash	There is data being transmitted or received via the Internet.
	Off	There is no successful Internet connection or the modem router is operating in Bridge mode. Please refer to <a href="#">Note 2</a> for troubleshooting.
📶 (WLAN)	On	Wireless is enabled but no data is being transmitted.
	Flash	The modem router is sending or receiving data over the wireless network.
	Off	Wireless function is disabled.
🔒 (WPS)	On	A wireless device has been successfully added to the network by WPS function.
	Flash	WPS handshaking is in process and will continue for about 2 minutes. Please press the WPS button on other wireless devices that you want to add to the network while the LED is flashing.
	Off	The WPS function is disabled or the wireless device fails to be added to the network in 2 minutes after WPS function is enabled. Please refer to <a href="#">4.3.3.1 WPS Settings</a> for more information.
🖥 (LAN 1-4)	On	There is a device connected to this LAN port.
	Flash	The modem router is sending or receiving data over this LAN port.
	Off	There is no device connected to this LAN port.

**Note:**

1. If the ADSL LED is off, please check your Internet connection first. Refer to [2.4 Connecting the Modem Router](#) for more information about how to make Internet connection correctly. If you have already made a right connection, please contact your ISP to make sure if your Internet service is available now.
2. If the Internet LED is off, please check your ADSL LED first. If your ADSL LED is also off, please refer to **Note 1**. If your ADSL LED is GREEN ON, please check your Internet configuration. You may need to check this part of information with your ISP and make sure everything have been input correctly. Refer to [4.1.1 Device Info](#) and [4.3.1 Internet](#) for more information.

## 2.2 The Back Panel

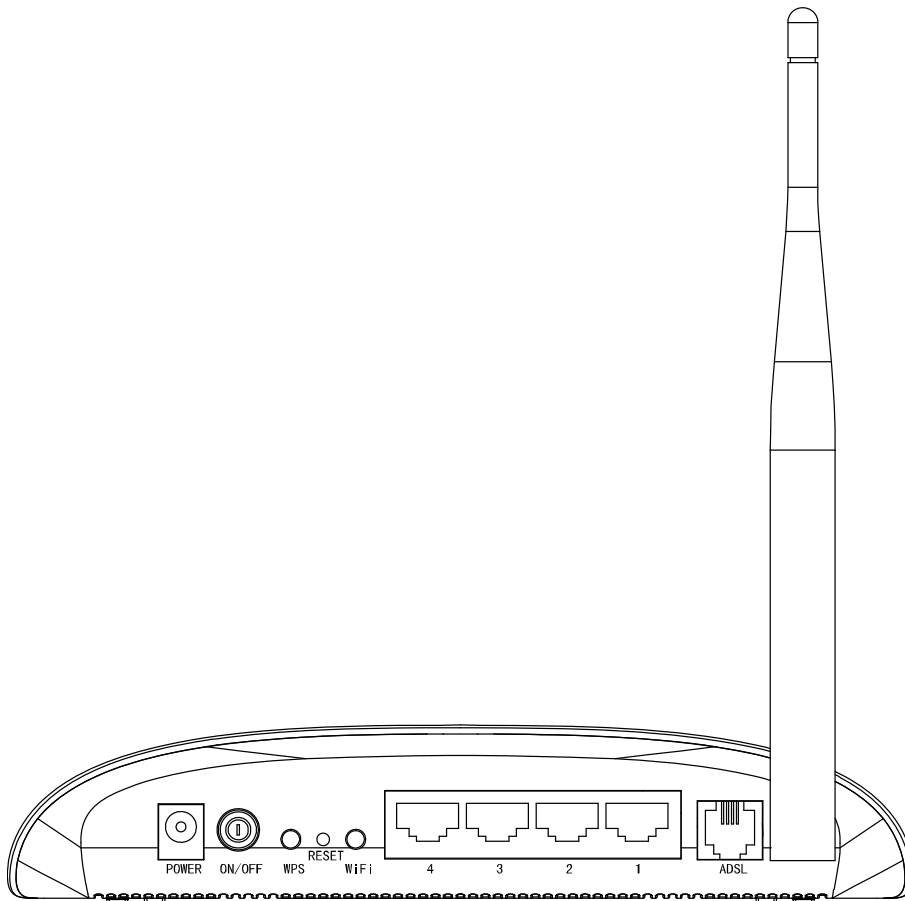

Figure 2-2

- **POWER:** The Power plug is where you will connect the power adapter.
- **ON/OFF:** The switch for the power.
- **WPS:** This button is for WPS settings. For details, please refer to [4.3.3.1 WPS Settings](#)
- **RESET:** There are two ways to reset the modem router's factory defaults.

**Method one:** With the modem router powered on, use a pin to press and hold the Reset button for at least 5 seconds. And the modem router will reboot to its factory default settings.

**Method two:** Restore the default setting from “Maintenance-SysRestart” of the modem router's Web-based Utility.

- **WiFi:** Press this button to enable or disable Wireless LAN interface.
- **1, 2, 3, 4 (LAN):** Through the port, you can connect the modem router to your PC or the other Ethernet network devices.
- **ADSL:** Through the port, you can connect the modem router with the telephone. Or you can connect them by an external separate splitter. For details, please refer to [2.4 Connecting the Modem Router](#).
- **Antenna:** Used for wireless operation and data transmit.

## 2.3 Installation Environment

- The Product should not be located where it will be exposed to moisture or excessive heat.
- Place the modem router in a location where it can be connected to the various devices as well as to a power source.
- Make sure the cables and power cord are safely placed out of the way so they do not create a tripping hazard.
- The modem router can be placed on a shelf or desktop.
- Keep away from the strong electromagnetic radiation and the device of electromagnetic sensitive.

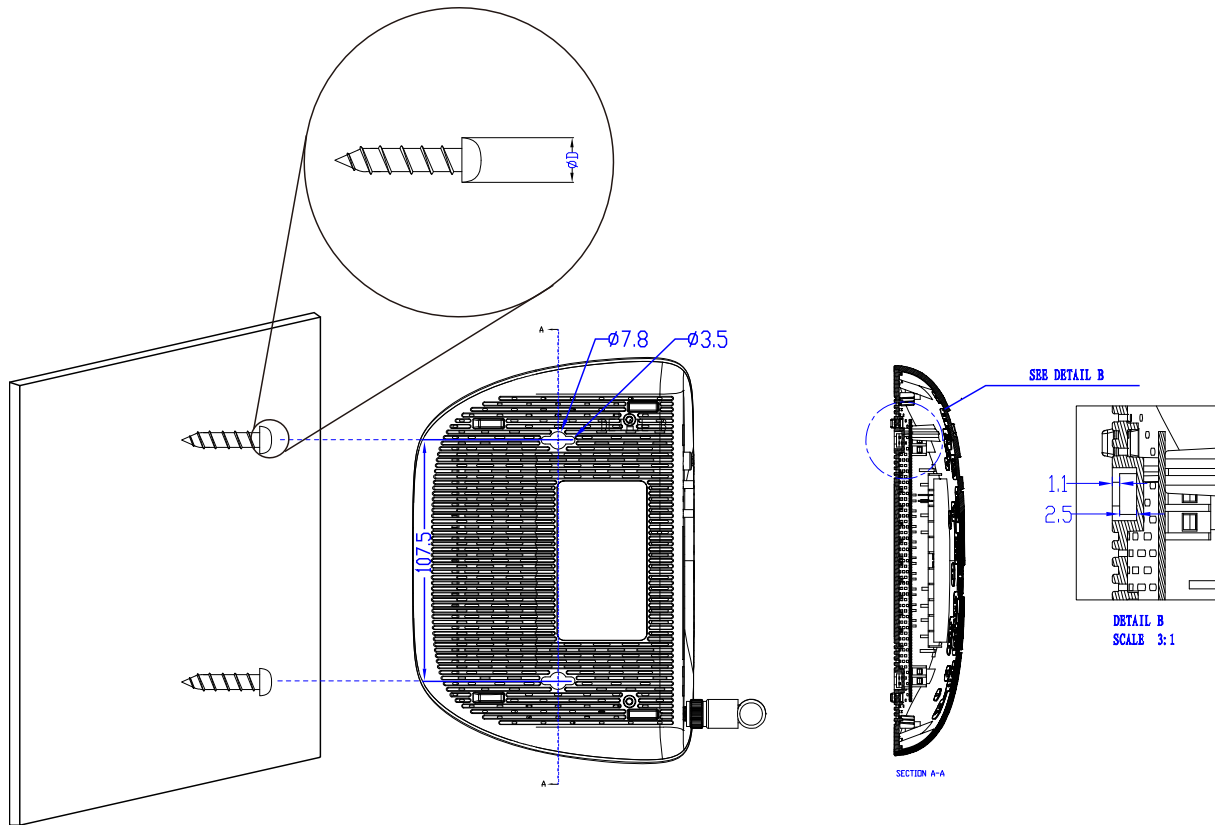

Figure 2-3 Wall-mount Install

**Note:**

The diameter of the screw,  $3.5\text{mm} < D < 7.8\text{mm}$ , and the distance of two screws is 107.5mm. The screw that project from the wall need around 4mm based, and the length of the screw need to be at least 20mm to withstand the weight of the product.

## 2.4 Connecting the Modem Router

Before installing the device, please make sure your broadband service provided by your ISP is available. If there is any problem, please contact your ISP. Before cable connection, cut off the power supply and keep your hands dry. You can follow the steps below to install it.

**Step 1:** Connect the ADSL Line.

**Method one:** Plug one end of the twisted-pair ADSL cable into the ADSL port on the rear panel of TD-W8951ND, and insert the other end into the wall socket.

**Method two:** You can use a separate splitter. External splitter can divide the data and voice, and then you can access the Internet and make calls at the same time. The external splitter has three ports:

- LINE: Connect to the wall jack

- PHONE: Connect to the phone sets
- MODEM: Connect to the ADSL port of TD-W8951ND

Plug one end of the twisted-pair ADSL cable into the ADSL port on the rear panel of TD-W8951ND. Connect the other end to the MODEM port of the external splitter.

**Step 2:** Connect the Ethernet cable. Attach one end of a network cable to your computer's Ethernet port or a regular hub/switch port, and the other end to the LAN port on the TD-W8951ND.

**Step 3:** Power on the computers and LAN devices.

**Step 4:** Attach the power adapter. Connect the power adapter to the power connector on the rear of the device and plug in the adapter to a electrical outlet or power extension. The electrical outlet shall be installed near the device and shall be easily accessible.

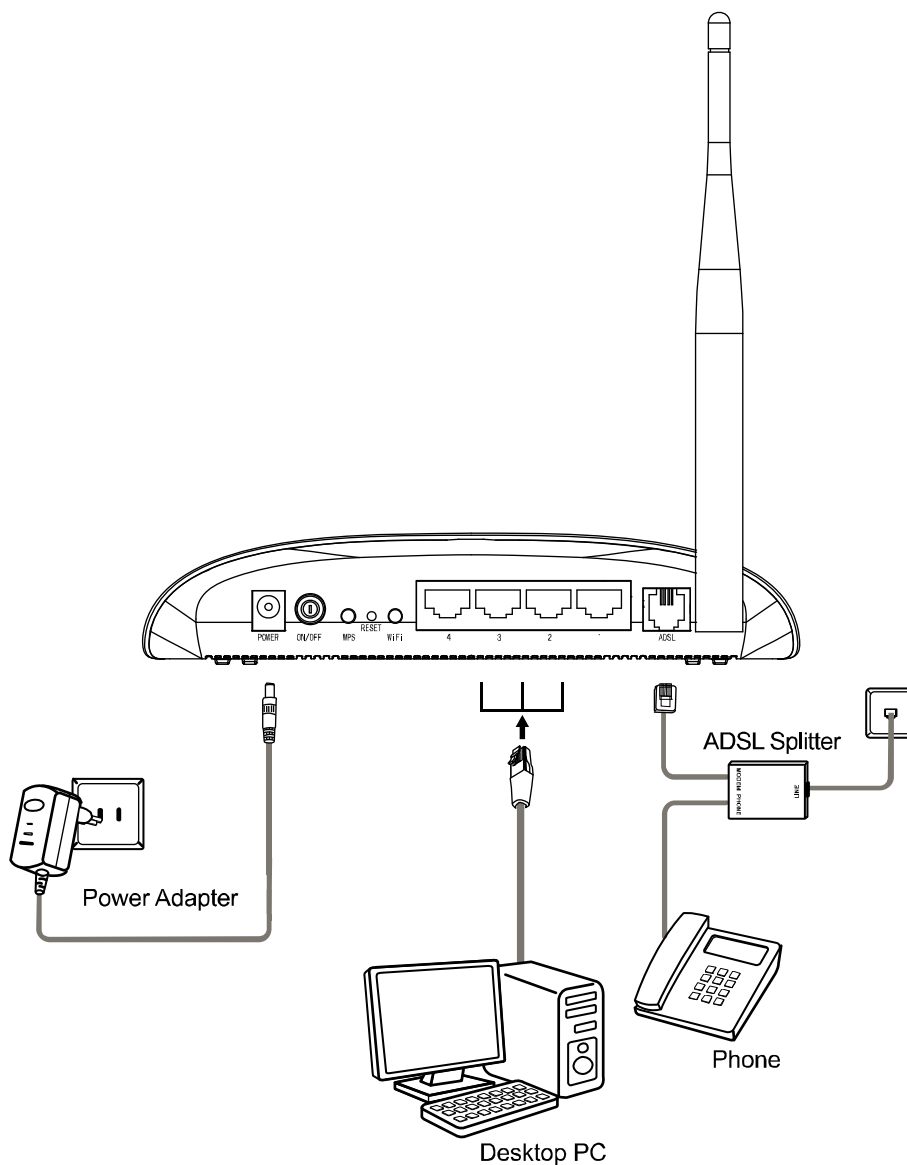

Figure 2-4



## Chapter 3. Quick Installation Guide

### 3.1 Configure PC

After you directly connect your PC to the TD-W8951ND or connect your adapter to a Hub/Switch which has connected to the modem router, you need to configure your PC's IP address. Follow the steps below to configure it.

**Step 1:** Click the **Start** menu on your desktop, right click **My Network Places**, and then select **Properties** (shown in Figure 3-1).

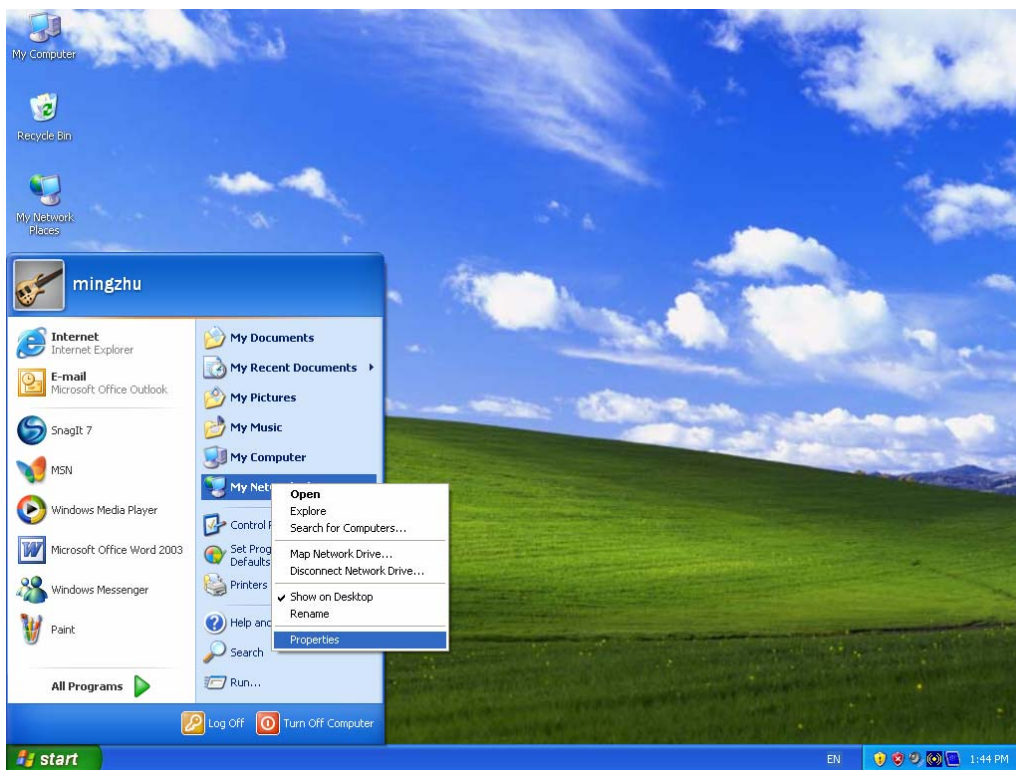

Figure 3-1

**Step 2:** Right click **Local Area Connection (LAN)**, and then select **Properties**.

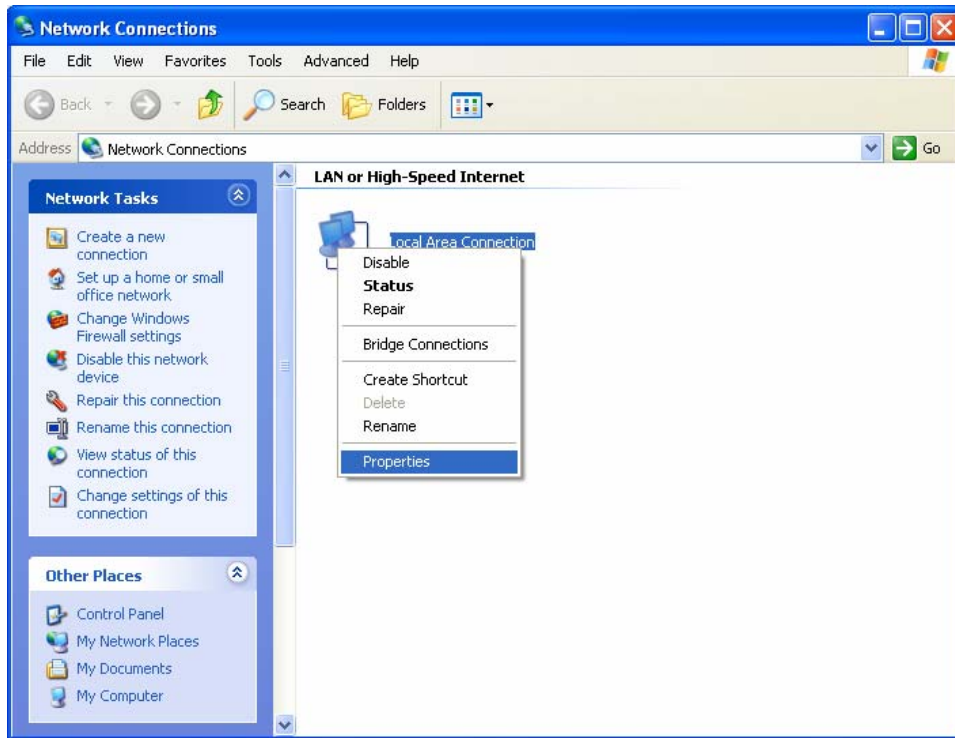

Figure 3-2

**Step 3:** Select **General** tab, highlight Internet Protocol (TCP/IP), and then click the **Properties** button.

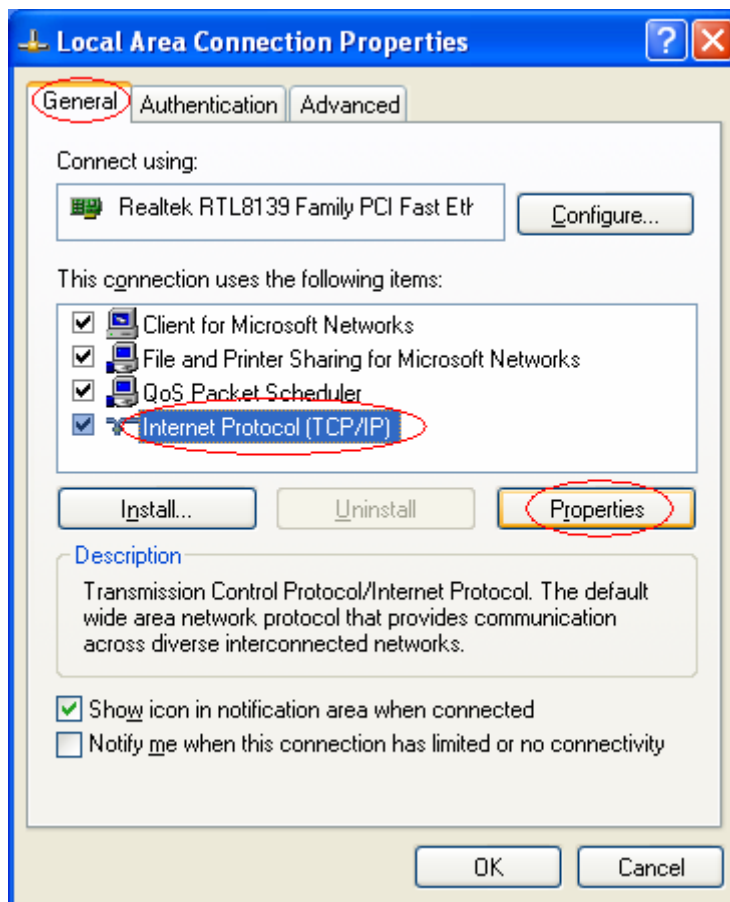

Figure 3-3

**Step 4:** Configure the IP address as Figure 3-4 shows. After that, click **OK**.

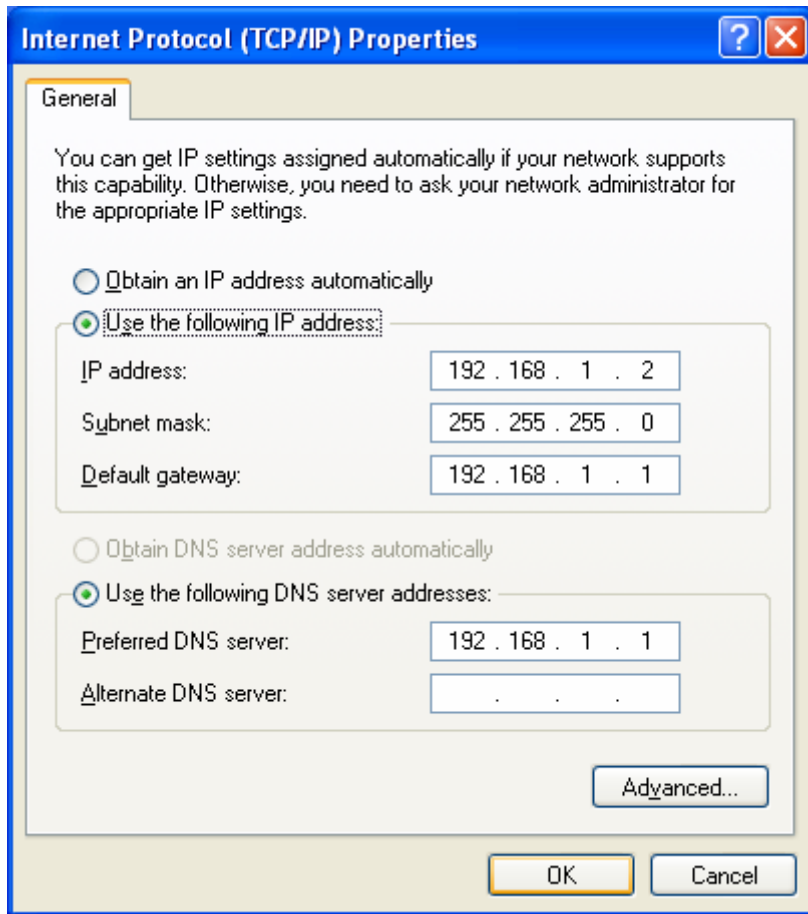

Figure 3-4

**Note:**

You can configure the PC to get an IP address automatically, select “Obtain an IP address automatically” and “Obtain DNS server address automatically” in the screen above.

Now, you can run the Ping command in the command prompt to verify the network connection. Please click the **Start** menu on your desktop, select **run** tab, type **cmd or command** in the field and press **Enter**. Type **ping 192.168.1.1** on the next screen, and then press **Enter**.

If the result displayed is similar to the screen below, the connection between your PC and the modem router has been established.

```

Pinging 192.168.1.1 with 32 bytes of data:

Reply from 192.168.1.1: bytes=32 time<1ms TTL=64
Reply from 192.168.1.1: bytes=32 time<1ms TTL=64
Reply from 192.168.1.1: bytes=32 time<1ms TTL=64
Reply from 192.168.1.1: bytes=32 time<1ms TTL=64

Ping statistics for 192.168.1.1:
    Packets: Sent = 4, Received = 4, Lost = 0 (0% loss),
    Approximate round trip times in milli-seconds:
        Minimum = 0ms, Maximum = 0ms, Average = 0ms

```

Figure 3-5

If the result displayed is similar to the screen shown below, it means that your PC has not connected to the modem router.

```

Pinging 192.168.1.1 with 32 bytes of data:

Request timed out.
Request timed out.
Request timed out.
Request timed out.

Ping statistics for 192.168.1.1:
    Packets: Sent = 4, Received = 0, Lost = 4 (100% loss),

```

Figure 3-6

You can check it follow the steps below:

**1) Is the connection between your PC and the modem router correct?**

The LEDs of LAN port which you link to the device and the LEDs on your PC's adapter should be lit.

**2) Is the TCP/IP configuration for your PC correct?**

If the modem router's IP address is 192.168.1.1, your PC's IP address must be within the range of 192.168.1.2 ~ 192.168.1.254.

## 3.2 Login

Once your host PC is properly configured, please proceed as follows to use the Web-based Utility: Start your web browser and type the private IP address of the modem router in the URL field:

**192.168.1.1.**

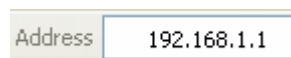

After that, you will see the screen shown below, enter the default User Name **admin** and the default Password **admin**, and then click **OK** to access to the **Quick Start** screen. You can follow the steps below to complete the Quick Start.



Figure 3-7

**Step 1:** Select the **Quick Start** tab, then click **RUN WIZARD**, and you will see the next screen. Click the **NEXT** button.

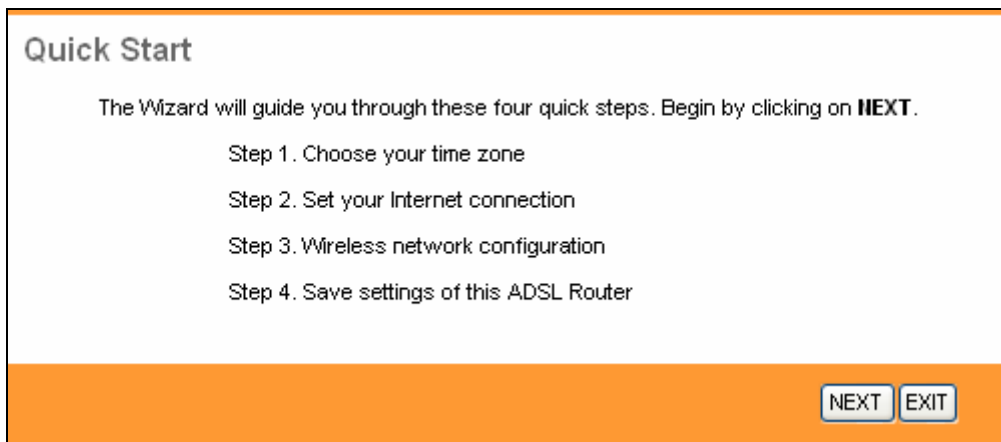

Figure 3-8

**Step 2:** Configure the time for the modem router, and then click the **NEXT** button.

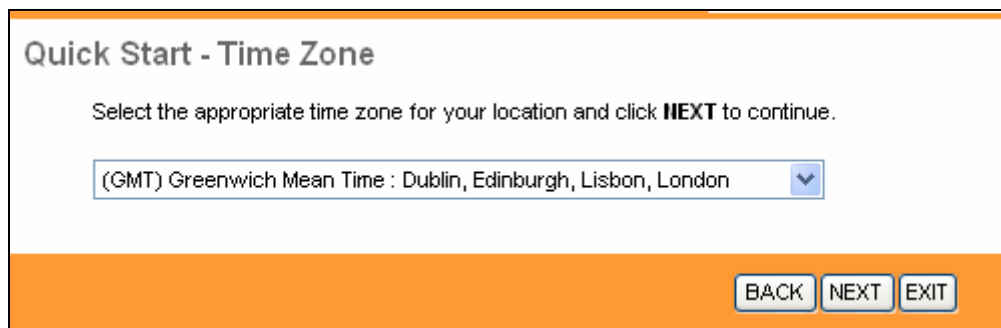

Figure 3-9

**Step 3:** Select the connection type to connect to the ISP (We select **PPPoE/PPPoA** mode for example here), and then click the **NEXT** button.

**Quick Start - ISP Connection Type**

Select the Internet connection type to connect to your ISP. Click **NEXT** to continue.

- Dynamic IP Address      Choose this option to obtain a IP address automatically from your ISP.
- Static IP Address      Choose this option to set static IP information provided to you by your ISP.
- PPPoE/PPPoA      Choose this option if your ISP uses PPPoE/PPPoA. (For most DSL users)
- Bridge Mode      Choose this option if your ISP uses Bridge Mode.

Figure 3-10

**Step 4:** Configure the following options provided by your ISP: **Username**, **Password**, **VPI**, **VCI** and **Connection Type**. Then click **NEXT**.

**Quick Start - PPPoE/PPPoA**

Enter the PPPoE/PPPoA information provided to you by your ISP. Click **NEXT** to continue.

Username:

Password:

VPI:  (0~255)

VCI:  (1~65535)

Connection Type:  ▼

Figure 3-11

**Step 5:** Configure the rules for the WLAN, and click **NEXT**.

**Quick Start - Wlan**

You may enable/disable Wlan, change the Wlan SSID and Authentication type in this page. Click **NEXT** to continue.

Access Point :  Activated  Deactivated

---

SSID :

Broadcast SSID :  Yes  No

Authentication Type :

---

Encryption :

Pre-Shared Key :  (8-63  
ASCII characters or 64 hexadecimal characters)

Figure 3-12

**Note:**

If the Access Point is activated, the wireless function will be available even without the external antenna because of an additional printed antenna. To adopt the wireless security protection measures, please refer to [4.3.3 Wireless](#).

**Step 6:** Click **NEXT** to finish the Quick Start.

**Quick Start Complete !!**

The Setup Wizard has completed. Click on **BACK** to modify changes or mistakes. Click **NEXT** to save the current settings.

Figure 3-13

## Chapter 4. Software Configuration

This User Guide recommends using the “Quick Installation Guide” for first-time installation. For advanced users, if you want to know more about this device and make use of its functions adequately, maybe you will get help from this chapter to configure the advanced settings through the Web-based Utility.

After your successful login, you can configure and manage the device. There are main menus on the top of the Web-based Utility; submenus will be available after you click one of the main menus. On the center of the Web-based Utility, there are the detailed configurations or status information. To apply any settings you have altered on the page, please click the **SAVE** button.

### 4.1 Status

Choose “**Status**”, you can see the next submenus: **Device Info**, **System Log** and **Statistics**. Click any of them, and you will be able to configure the corresponding function.



Figure 4-1

Click any of them, and you will be able to view the corresponding information.

#### 4.1.1 Device Info

Choose “**Status**→**Device Info**” menu, and you will be able to view the device information, including LAN, WAN and ADSL. The information will vary depending on the settings of the modem router configured on the Interface Setup screen.



The screenshot shows the 'Status' page of the TD-W8951ND modem router. The navigation menu at the top includes 'Quick Start', 'Interface Setup', 'Advanced Setup', 'Access Management', 'Maintenance', 'Status', and 'Help'. The 'Status' menu is active, and its sub-menu 'Device Info' is highlighted with a red circle. Below the navigation, the page is divided into several sections:

- Device Information:** Shows Firmware Version: 5.0.0 Build 120522 Rel.23978 and MAC Address: 00:aa:bb:11:22:39.
- LAN:** Shows IP Address: 192.168.1.1, Subnet Mask: 255.255.255.0, and DHCP Server: Enabled.
- Wireless:** Shows 'Current Connected Wireless Clients number is 0' with a 'Refresh' button. Below this is a table with columns 'ID' and 'MAC'.
- WAN:** Contains a table with columns: PVC, VPI/CI, IP Address, Subnet, GateWay, DNS Server, Encapsulation, and Status.
 

PVC	VPI/CI	IP Address	Subnet	GateWay	DNS Server	Encapsulation	Status
PVC0	8/35	0.0.0.0	0.0.0.0	0.0.0.0	0.0.0.0	PPPoE	Down
PVC1	8/36	N/A	N/A	N/A	N/A	Bridge	Down
PVC2	8/37	N/A	N/A	N/A	N/A	Bridge	Down
- ADSL:** Shows ADSL Firmware Version: FwVer:3.20.17.0\_TC3087 HwVer:T14.F7\_11.2, Line State: Down, Modulation: N/A, and Annex Mode: N/A. Below this is a table with columns: SNR Margin, Line Attenuation, Data Rate, Max Rate, CRC, Downstream, and Upstream.
 

	Downstream	Upstream	
SNR Margin :	N/A	N/A	db
Line Attenuation :	N/A	N/A	db
Data Rate :	N/A	N/A	kbps
Max Rate :	N/A	N/A	kbps
CRC :	N/A	N/A	

Figure 4-2

**Note:**

Click the other submenus **System Log** or **Statistics** in Figure 4-2, and you will be able to view the system log and traffic statistics about the modem router.

### 4.1.2 System Log

Choose “**Status**→**System Log**” menu, and you will be able to query the logs of the modem router.

The screenshot shows the 'System Log' page in the modem router's web interface. The navigation menu at the top includes 'Quick Start', 'Interface Setup', 'Advanced Setup', 'Access Management', 'Maintenance', 'Status', and 'Help'. Under the 'Status' menu, there are three sub-items: 'Device Info', 'System Log' (highlighted with a red circle), and 'Statistics'. The main content area displays a scrollable list of system log entries. Each entry consists of a timestamp (e.g., '9/8/2010 11:40:8>') followed by a message (e.g., 'Last errorlog repeat 10 Times'). The messages include error reports, task failure notifications, and task pause notifications. At the bottom of the page, there are two buttons: 'CLEAR LOG' and 'SAVE LOG'.

Figure 4-3

The modem router can keep logs of all traffic. You can query the logs to find what happened to the Router.

Click the **CLEAR LOG** button to clear the logs.

Click the **SAVE LOG** button to save the logs.

### 4.1.3 Statistics

Choose “**Status**→**Statistics**” menu, and you will be able to view the network traffic over Ethernet, ADSL and WLAN.

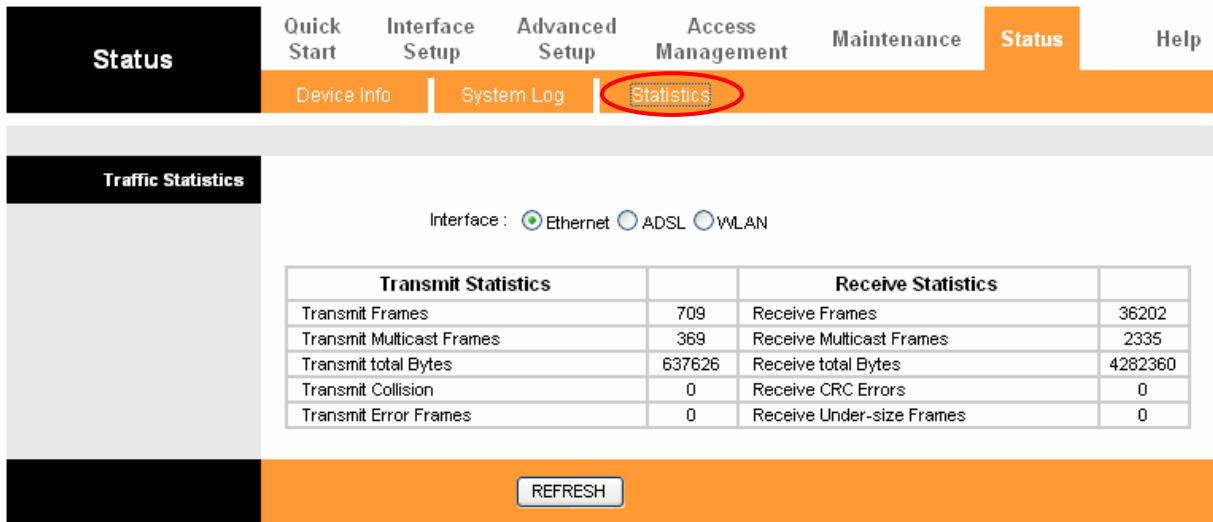

Figure 4-4

- **Interface:** You can select **Ethernet**, **ADSL** and **WLAN** to view the corresponding network traffic over different ports.
- Select **Ethernet**, and you will see the statistics table as below.

Interface : <input checked="" type="radio"/> Ethernet <input type="radio"/> ADSL <input type="radio"/> WLAN			
Transmit Statistics		Receive Statistics	
Transmit Frames	709	Receive Frames	36202
Transmit Multicast Frames	369	Receive Multicast Frames	2335
Transmit total Bytes	637626	Receive total Bytes	4282360
Transmit Collision	0	Receive CRC Errors	0
Transmit Error Frames	0	Receive Under-size Frames	0

**Statistics Table:**

<b>Transmit Statistics</b>	<b>Transmit Frames</b>	The frames transmitted over the Ethernet port.
	<b>Transmit Multicast Frames</b>	The multicast frames transmitted over the Ethernet port.
	<b>Transmit total Bytes</b>	The total bytes transmitted over the Ethernet port.
	<b>Transmit Collision</b>	The collision occurred over the Ethernet port when data is being transmitted.
	<b>Transmit Error Frames</b>	The error frames over the Ethernet port when data is being transmitted.
<b>Receive Statistics</b>	<b>Receive Frames</b>	The frames received over the Ethernet port.
	<b>Receive Multicast Frames</b>	The multicast frames received over the Ethernet port.
	<b>Receive total Bytes</b>	The total bytes received over the Ethernet port.
	<b>Receive CRC Errors</b>	The CRC errors occurred over the Ethernet port when data is being received.
	<b>Receive Under-size Frames</b>	The Under-size frames received over the Ethernet port.

- Select **ADSL**, and you will see the statistics table as below.

Interface : <input type="radio"/> Ethernet <input checked="" type="radio"/> ADSL <input type="radio"/> WLAN			
Transmit Statistics		Receive Statistics	
Transmit total PDUs	0	Receive total PDUs	0
Transmit total Error Counts	0	Receive total Error Counts	0

**Statistics Table:**

<b>Transmit Statistics</b>	<b>Transmit total PDUs</b>	The total PDUs transmitted over the ADSL port.
	<b>Transmit total Error Counts</b>	The total errors occurred over the ADSL port when data is being transmitted.
<b>Receive Statistics</b>	<b>Receive total PDUs</b>	The total PDUs transmitted over the ADSL port.
	<b>Receive total Error Counts</b>	The total errors occurred over the ADSL port when data is being received.

- Select **WLAN**, and you will see the statistics table as below.

Interface : <input type="radio"/> Ethernet <input type="radio"/> ADSL <input checked="" type="radio"/> WLAN			
Transmit Statistics		Receive Statistics	
Tx Frames Count	5170	Rx Frames Count	35426
Tx Errors Count	6	Rx Errors Count	8000
Tx Drops Count	6	Rx Drops Count	8000

**Statistics Table:**

<b>Transmit Statistics</b>	<b>Tx Frames Count</b>	The frames transmitted over the WLAN when wireless data is being transmitted.
	<b>Tx Errors Count</b>	The errors occurred over the WLAN when wireless data is being transmitted.
	<b>Tx Drops Count</b>	The drops occurred over the WLAN when wireless data is being transmitted.
<b>Receive Statistics</b>	<b>Rx Frames Count</b>	The frames received over the WLAN when wireless data is being transmitted.
	<b>Rx Errors Count</b>	The errors occurred over the WLAN when wireless data is being received.
	<b>Rx Drops Count</b>	The drops occurred over the WLAN when wireless data is being received.

Click the **REFRESH** button to refresh immediately.

## 4.2 Quick Start

Please refer to [3.2 Login](#).

## 4.3 Interface Setup

Choose “**Interface Setup**”, you can see the next submenus: **Internet**, **LAN** and **Wireless**.



Figure 4-5

Click any of them, and you will be able to configure the corresponding function.

### 4.3.1 Internet

Choose “**Interface Setup**→**Internet**” menu, you can configure the parameters for WAN ports in the next screen (shown in Figure 4-6).

Interface	Quick Start	Interface Setup	Advanced Setup	Access Management	Maintenance	Status	Help
	Internet	LAN	Wireless				
<b>ATM VC</b>							
QoS	Virtual Circuit : PVC0 <input type="button" value="PVCs Summary"/> Status : <input checked="" type="radio"/> Activated <input type="radio"/> Deactivated VPI : 8 (range: 0~255) VCI : 35 (range: 1~65535)						
	ATM QoS : UBR PCR : 0 cells/second SCR : 0 cells/second MBS : 0 cells						
<b>Encapsulation</b>							
ISP : <input type="radio"/> Dynamic IP Address <input type="radio"/> Static IP Address <input checked="" type="radio"/> PPPoA/PPPoE <input type="radio"/> Bridge Mode							
<b>PPPoE/PPPoA</b>							
Connection Setting	Servicename : <input type="text"/> Username : <input type="text"/> Password : <input type="text"/> Encapsulation : PPPoE LLC Bridge Interface : <input type="radio"/> Activated <input checked="" type="radio"/> Deactivated						
	Connection : <input checked="" type="radio"/> Always On (Recommended) <input type="radio"/> Connect On-Demand (Close if idle for <input type="text" value="0"/> minutes) <input type="radio"/> Connect Manually TCP MSS Option : TCP MSS(default: 1400) <input type="text" value="1400"/> bytes						
IP Address	Get IP Address : <input type="radio"/> Static <input checked="" type="radio"/> Dynamic Static IP Address : <input type="text" value="0.0.0.0"/> IP Subnet Mask : <input type="text" value="0.0.0.0"/> Gateway : <input type="text" value="0.0.0.0"/> NAT : Enable Default Route : <input checked="" type="radio"/> Yes <input type="radio"/> No TCP MTU Option : TCP MTU(default: 1480) <input type="text" value="1480"/> bytes Dynamic Route : RIP2-B Direction : Both Multicast : Disabled						
	<input type="button" value="SAVE"/>						

Figure 4-6

➤ **ATM VC:** ATM settings are used to connect to your ISP. Your ISP provides VPI (Virtual Path Identifier), VCI (Virtual Channel Identifier) settings to you. In this Device, you can totally setup 8 VCs on different encapsulations, if you apply 8 different virtual circuits from your ISP. You need to activate the VC to take effect. For PVCs management, you can use ATM QoS to setup each PVC traffic line's priority.

- **Virtual Circuit:** Select the VC number you want to setup, PVC0~PVC7.
- **Status:** If you want to use a designed VC, you should activate it.

- **VPI:** Identifies the virtual path between endpoints in an ATM network. The valid range is from 0 to 255. Please input the value provided by your ISP.
  - **VCI:** Identifies the virtual channel endpoints in an ATM network. The valid range is from 32 to 65535 (1 to 31 is reserved for well-known protocols). Please input the value provided by your ISP.
  - **PVCs Summary:** Click the button, and you can view the summary information about the PVCs.
  - **QoS:** Select the Quality of Service types for this Virtual Circuit, including CBR (Constant Bit Rate), UBR (Unspecified Bit Rate) and VBR (Variable Bit Rate). These QoS types are all controlled by the parameters specified below, including PCR (Peak Cell Rate), SCR (Sustained Cell Rate) and MBS (Maximum Burst Size), please configure them according to your needs.
- **Encapsulation:** There are four connection types: Dynamic IP Address, Static IP Address, PPPoA/PPPoE and Bridge Mode. Please choose the designed type that you want to use. After that, you should follow the configuration below to proceed.

### 1) Dynamic IP Address

Select this option if your ISP provides you an IP address automatically. This option is typically used for Cable services. Please enter the Dynamic IP information accordingly.

ISP :  Dynamic IP Address  
 Static IP Address  
 PPPoA/PPPoE  
 Bridge Mode

---

Encapsulation : 1483 Bridged IP LLC

Bridge Interface :  Activated  Deactivated

NAT : Enable

Default Route :  Yes  No

TCP MTU Option : TCP MTU(default:1500) 1500 bytes

Dynamic Route : RIP2-B      Direction : Both

Multicast : Disabled

Figure 4-7

- **Encapsulation:** Select the encapsulation mode for the Dynamic IP Address, you can leave it default.
- **NAT:** Select this option to Enable/Disable the NAT (Network Address Translation) function for this VC. The NAT function can be activated or deactivated per PVC basis.

- **Default Route:** If enable this function, the current PVC will be considered as the default gateway to internet from this device.
- **TCP MTU Option:** Enter the TCP MTU as your desire.
- **Dynamic Route:** Select this option to specify the RIP (Routing Information protocol) version for WAN interface, including **RIP1**, **RIP2-B** and **RIP2-M**. RIP2-B and RIP2-M are both sent in RIP2 format, the difference is that RIP2-M using Multicast, while RIP2-B using Broadcast format.
  - **Direction:** Select this option to specify the RIP direction. **None** is for disabling the RIP function. **Both** means the ADSL modem router will periodically send routing information and accept routing information, and then incorporate them into routing table. **IN only** means the ADSL modem router will only accept but will not send RIP packet. **OUT only** means the ADSL modem router will only send but will not accept RIP packet.
- **Multicast:** Select IGMP version, or disable the function. IGMP (Internet Group Multicast Protocol) is a session-layer protocol used to establish membership in a multicast group. The ADSL ATU-R supports both IGMP version 1 (**IGMP v1**) and **IGMP v2**. Select “Disabled” to disable it.

## 2) Static IP Address

Select this option if your ISP provides static IP information to you. You should set static IP address, IP subnet mask, and gateway address in the screen below (shown in Figure 4-8).

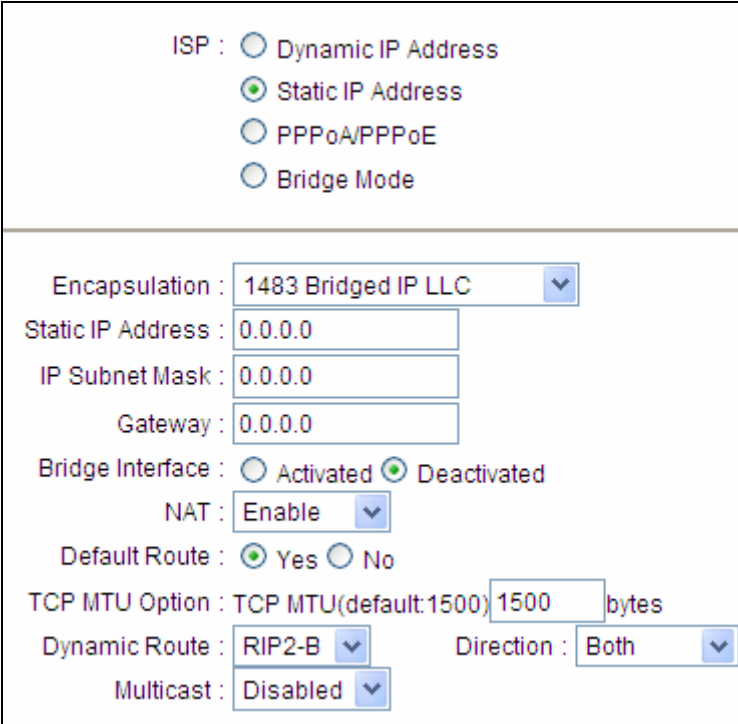

ISP :  Dynamic IP Address  
 Static IP Address  
 PPPoA/PPPoE  
 Bridge Mode

---

Encapsulation : 1483 Bridged IP LLC

Static IP Address : 0.0.0.0

IP Subnet Mask : 0.0.0.0

Gateway : 0.0.0.0

Bridge Interface :  Activated  Deactivated

NAT : Enable

Default Route :  Yes  No

TCP MTU Option : TCP MTU(default:1500) 1500 bytes

Dynamic Route : RIP2-B      Direction : Both

Multicast : Disabled

Figure 4-8



**Note:**

Each IP address entered in the fields must be in the appropriate IP form, which is four IP octets separated by a dot (x.x.x.x), such as 192.168.1.100. The modem router will not accept the IP address if it is not in this format.

**3) PPPoA/PPPoE**

Select this option if your ISP requires you to use a PPPoE connection. This option is typically used for DSL services. Select Dynamic PPPoE to obtain an IP address automatically for your PPPoE connection. Select Static PPPoE to use a static IP address for your PPPoE connection. Please enter the information accordingly.

Figure 4-9

- **Servicename:** Enter a name to mark current connection, or you can leave it blank.
- **Username:** Enter your username for your PPPoA/PPPoE connection.

- **Password:** Enter your password for your PPPoA/PPPoE connection.
- **Encapsulation:** For both PPPoA/PPPoE connection, you need to specify the type of Multiplexing, either LLC or VC Mux.
- **Bridge Interface:** Activate the option, and the modem router can also work in Bridge mode.
- **Connection:** For PPPoA/PPPoE connection, you can select **Always on** or **Connect on-Demand** or **Connect Manually**. Connect on demand is dependent on the traffic. If there is no traffic (or **Idle**) for a pre-specified period of time), the connection will tear down automatically. And once there is traffic send or receive, the connection will be automatically on.
- **Static/Dynamic IP Address:** For PPPoA/PPPoE connection, you need to specify the public IP address for this ADSL modem router. The IP address can be either dynamically (via DHCP) or given IP address provided by your ISP. For Static IP, you need to specify the IP address, Subnet Mask and Gateway IP address.
- **Default Route:** You should select **Yes** to configure the PVC as the default gateway to internet from this device.

#### 4) Bridge Mode

If you select this type of connection, the modem can be configured to act as a bridging device between your LAN and your ISP. Bridges are devices that enable two or more networks to communicate as if they are two segments of the same physical LAN.

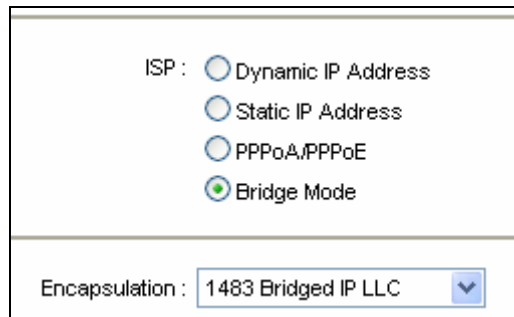

The screenshot shows a configuration window for the Internet Service Provider (ISP). Under the heading "ISP:", there are four radio button options: "Dynamic IP Address", "Static IP Address", "PPPoA/PPPoE", and "Bridge Mode". The "Bridge Mode" option is selected, indicated by a green dot. Below this section, there is a label "Encapsulation:" followed by a dropdown menu that currently displays "1483 Bridged IP LLC".

Figure 4-10

#### **Note:**

After you finish the Internet configuration, please click **SAVE** to make the settings take effect.

#### 4.3.2 LAN

Choose "**Interface Setup**→**LAN**" menu, and you will see the LAN screen (shown in Figure 4-11). Please configure the parameters for LAN ports according to the descriptions below.

The screenshot shows the 'Interface' configuration page for the LAN interface. The 'LAN' tab is highlighted. The configuration is divided into several sections: Router Local IP, DHCP, DHCP Server, DHCP Table, and DNS. The Router Local IP section includes fields for IP Address (192.168.1.1), IP Subnet Mask (255.255.255.0), Dynamic Route (RIP2-B), Direction (Both), Multicast (IGMP v2), and IGMP Snoop (Enabled). The DHCP section has a radio button for 'Enabled'. The DHCP Server section includes Starting IP Address (192.168.1.2), IP Pool Count (100), Lease Time (259200 seconds), and Physical Ports (1, 2, 3, 4) with checkboxes. The DHCP Table section contains a table with columns for Hostname, IP Address, MAC Address, Status, and Expire Time. The DNS section includes DNS Relay (Use Auto Discovered DNS Server Only), Primary DNS Server (N/A), and Secondary DNS Server (N/A). At the bottom are 'SAVE' and 'CANCEL' buttons.

Figure 4-11

- **Router Local IP:** These are the IP settings of the LAN interface for the device. These settings may be referred to as Private settings. You may change the LAN IP address if needed. The LAN IP address is private to your internal network and cannot be seen on the Internet.
  - **IP Address:** Enter the modem router's local IP Address, then you can access to the Web-based Utility via the IP Address, the default value is 192.168.1.1.
  - **IP Subnet Mask:** Enter the modem router's Subnet Mask, the default value is 255.255.255.0.
  - **Dynamic Route:** Select this option to specify the RIP (Routing Information protocol) version for LAN interface, including **RIP1**, **RIP2-B** and **RIP2-M**. RIP2-B and RIP2-M are both sent in RIP2 format, the difference is that RIP2-M using Multicast, while RIP2-B using Broadcast format.
  - **Direction:** Select this option to specify the RIP direction. **None** is for disabling the RIP function. **Both** means the ADSL modem router will periodically send routing information and accept routing information, and then incorporate them into routing table. **IN only** means the ADSL modem router will only accept but will not send RIP packet. **OUT only**

means the ADSL modem router will only send but will not accept RIP packet.

- **Multicast:** Select IGMP version, or disable the function. IGMP (Internet Group Multicast Protocol) is a session-layer protocol used to establish membership in a multicast group. The ADSL ATU-R supports both IGMP version 1 (**IGMP v1**), **IGMP v2** and **IGMP v3**. Select “Disabled” to disable it.
  - **IGMP Snoop:** Enable the IGMP Snoop function if you need.
- **DHCP Server:** Select **Enabled**, then you will see the screen below (shown in Figure 4-12). The modem router will work as a DHCP Server; it becomes the default gateway for DHCP client connected to it. DHCP stands for Dynamic Host Control Protocol. The DHCP Server gives out IP addresses when a device is booting up and request an IP address to be logged on to the network. That device must be set as a DHCP client to obtain the IP address automatically. By default, the DHCP Server is enabled. The DHCP address pool contains the range of the IP address that will automatically be assigned to the clients on the network.

DHCP:  Disabled  Enabled  Relay

Starting IP Address:

IP Pool Count:

Lease Time:  seconds (0 sets to default value of 259200)

Physical Ports:  1  2  3  4

Hostname	IP Address	MAC Address	Status	Expire Time
	<input type="text" value="192.168.1.3"/>	<input type="text" value="Manual Config"/>	<input type="text" value="Static"/>	
tp-113ea910272d	192.168.1.2	40:61:86:FC:74:93	Auto	2days, 23:59:8

DNS Relay:

Primary DNS Server:

Secondary DNS Server:

Figure 4-12

- **Starting IP Address:** Enter the starting IP address for the DHCP server's IP assignment. Because the default IP address for the modem router is 192.168.1.1, the default Start IP Address is **192.168.1.2**, and the Start IP Address must be 192.168.1.2 or greater, but smaller than 192.168.1.254.
- **IP Pool Count:** The max user pool size.
- **Lease Time:** The length of time for the IP lease. After the dynamic IP address has expired, the user will be automatically assigned a new dynamic IP address. The default is **259200** seconds.
- **Physical Ports:** If a physical port is unchecked, the client connected to that port will not

be able to obtain IP address automatically although the DHCP function is enabled. All the ports are checked by default.

- **DNS Relay:** If you want to disable this feature, you just need to set both Primary and secondary DNS IP to 0.0.0.0. If you want to use DNS relay, you can setup DNS server IP to 192.168.1.1 on their Computer. If not, the device will perform as no DNS relay.
- **Primary DNS Server:** Type in your preferred DNS server.
- **Secondary DNS Server:** Type in your preferred DNS server.
- **Current Pool Summary:** Click the button, then you can view the IP addresses that the DHCP Server gives out.

 **Note:**

If **Use Auto Discovered DNS Server Only** is selected in DNS Relay, this modem router will accept the first received DNS assignment from one of the PPPoA, PPPoE or MER/DHCP enabled PVC(s) during the connection establishment. If **Use User Discovered DNS Server Only** is selected in DNS Relay, it is necessary for you to enter the primary and optional secondary DNS server IP addresses. After type in the address, click **SAVE** button to save it and invoke it.

- **DHCP Relay:** Select **Relay**, then you will see the next screen (shown in Figure 4-13), and the modem router will work as a DHCP Relay. A DHCP relay is a computer that forwards DHCP data between computers that request IP addresses and the DHCP server that assigns the addresses. Each of the device's interfaces can be configured as a DHCP relay. If it is enabled, the DHCP requests from local PCs will forward to the DHCP server runs on WAN side. To have this function working properly, please run on router mode only, disable the DHCP server on the LAN port, and make sure the routing table has the correct routing entry.

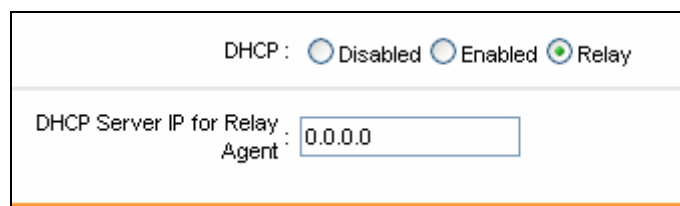

Figure 4-13

- **DHCP Server IP for Relay Agent:** Enter the DHCP server IP Address runs on WAN side.

 **Note:**

If you select **Disabled**, the DHCP function will not take effect.

### 4.3.3 Wireless

Choose “**Interface Setup**→**Wireless**” menu, and you will see the Wireless screen (shown in

Figure 4-14 ). Please configure the parameters for wireless according to the descriptions below.

Interface	Quick Start	Interface Setup	Advanced Setup	Access Management	Maintenance	Status	Help
	Internet	LAN	Wireless				
<b>Access Point Settings</b>	Access Point : <input checked="" type="radio"/> Activated <input type="radio"/> Deactivated Channel : UNITED STATES <input type="button" value="v"/> Auto <input type="button" value="v"/> Current Channel: 11 Transmit Power : High <input type="button" value="v"/> Beacon Interval(ms) : 100 (range: 20~1000) RTS/CTS Threshold : 2347 (range: 1500~2347) Fragmentation Threshold (bytes) : 2346 (range: 256~2346, even numbers only) DTIM(ms) : 1 (range: 1~255) Wireless Mode : 802.11b+g+n <input type="button" value="v"/>						
<b>11n Settings</b>	Channel Bandwidth : 20/40 MHz <input type="button" value="v"/> Extension Channel : above the control channel <input type="button" value="v"/> Guard Interval : AUTO <input type="button" value="v"/> MCS : AUTO <input type="button" value="v"/>						
<b>Multiple SSIDs Settings</b>	SSID Index : 1 <input type="button" value="v"/> Broadcast SSID : <input checked="" type="radio"/> Yes <input type="radio"/> No Use WPS : <input checked="" type="radio"/> Yes <input type="radio"/> No						
<b>WPS Settings</b>	WPS state : Unconfigured WPS mode : <input type="radio"/> PIN code <input checked="" type="radio"/> PBC <input type="button" value="Start WPS"/> WPS progress : Idle <input type="button" value="Reset to OOB"/> SSID : TP-LINK_774400 Authentication Type : Disabled <input type="button" value="v"/>						
<b>WDS Settings</b>	WDS Mode : <input type="radio"/> On <input checked="" type="radio"/> Off Mac Address #1 : 00:00:00:00:00:00 Mac Address #2 : 00:00:00:00:00:00 Mac Address #3 : 00:00:00:00:00:00 Mac Address #4 : 00:00:00:00:00:00						
<b>Wireless MAC Address Filter</b>	Active : <input type="radio"/> Activated <input checked="" type="radio"/> Deactivated Action : Allow Association <input type="button" value="v"/> the follow Wireless LAN station(s) association. Mac Address #1 : 00:00:00:00:00:00 Mac Address #2 : 00:00:00:00:00:00 Mac Address #3 : 00:00:00:00:00:00 Mac Address #4 : 00:00:00:00:00:00 Mac Address #5 : 00:00:00:00:00:00 Mac Address #6 : 00:00:00:00:00:00 Mac Address #7 : 00:00:00:00:00:00 Mac Address #8 : 00:00:00:00:00:00						
<input type="button" value="SAVE"/> <input type="button" value="CANCEL"/>							

Figure 4-14

- **Access point Settings:** These are the settings of the access point. You can configure the rules to allow wireless-equipped computers and other devices to communicate with a wireless network.
- **Access point:** Select Activated to allow wireless station to associate with the access point.
  - **Channel:** Select your region and the channel you want to use from the drop-down List of Channel. This field determines which operating frequency will be used. It is not necessary to change the default channel unless you notice interference problems with another nearby access point.
  - **Transmit Power:** Here you can specify the transmit power of modem router. You can select High, Medium or Low which you would like. High is the default setting and is recommended.
  - **Beacon Interval:** Enter a value between 20-1000 milliseconds. The Beacon Interval value indicates the frequency interval of the beacon. A beacon is a packet broadcast by the modem router to synchronize the wireless network. The default value is 100.
  - **RTS/CTS Threshold:** Should you encounter inconsistent data flow, only minor reduction of the default value 2347 is recommended. If a network packet is smaller than the preset RTS threshold size, the RTS/CTS mechanism will not be enabled. The modem router sends Request to Send (RTS) frames to a particular receiving station and negotiates the sending of a data frame. After receiving an RTS, the wireless station responds with a Clear to Send (CTS) frame to acknowledge the right to begin transmission. In most cases, keep its default value of 2347.
  - **Fragmentation Threshold:** This value specifies the maximum size for a packet before data is fragmented into multiple packets. If you experience a high packet error rate, you may slightly increase the Fragmentation Threshold. Setting the Fragmentation Threshold too low may result in poor network performance. Only minor reduction of the default value is recommended. In most cases, it should remain at its default value of 2346.
  - **DTIM:** This value, between 1 and 255, indicates the interval of the Delivery Traffic Indication Message (DTIM). A DTIM field is a countdown field informing clients of the next window for listening to broadcast and multicast messages. When the modem router has buffered broadcast or multicast messages for associated clients, it sends the next DTIM with a DTIM Interval value. Its clients hear the beacons and awaken to receive the broadcast and multicast messages. The default value is 1.
  - **Wireless Mode:** In the drop-down list you can select “802.11b”, “802.11g”, “802.11n”, “802.11b+g”, “802.11g+n” and “802.11b+g+n”. “802.11b+g+n” allows 802.11b, 802.11g and 802.11n wireless stations to connect to the modem router.

- **11n Settings:** These are the settings of the 11n parameters. If “802.11n”, “802.11g+n” or “802.11b+g+n” is selected for **Wireless mode**, these settings will be displayed.
  - **Channel Bandwidth:** Select the Bandwidth you want to use from the drop-down List. There are two options, “20 MHz” and “20/40 MHz”. If bigger bandwidth is selected, device could transmit and receive data with higher speed.
  - **Extension Channel:** If “20/40 MHz” is selected, this option will be displayed.
  - **Guard Interval:** Select the guard interval you want from the drop-down list.
  - **MCS:** Select the wireless transmission rate from the drop-down list. By default, the option is AUTO.
- **Multiple SSIDs Settings:** These are the settings of the SSID.
  - **SSID Index:** The index of the SSID, and in this model, you can only leave it as a default value of 1.
  - **Broadcast SSID:** When wireless clients survey the local area for wireless networks to associate with, they will detect the SSID broadcast by the modem router. To broadcast the modem router’s SSID, keep the default setting. If you don’t want to broadcast the modem router’s SSID, select “No”.
  - **Use WPS:** Use WPS (Wi-Fi Protected Setup) function, you can add a new wireless device to an existing network quickly. To Use WPS, keep the default setting, and configure the parameters in **WPS Settings**. If you don’t want to Use WPS, select “No”, then you will see the screen as shown below.

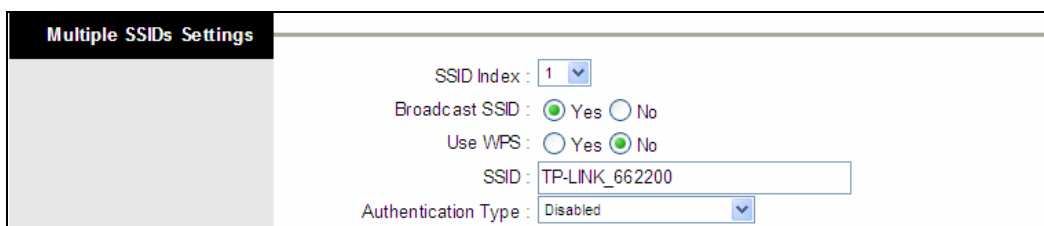

The screenshot shows the 'Multiple SSIDs Settings' configuration page. It includes the following fields and options:

- SSID Index:** A dropdown menu set to '1'.
- Broadcast SSID:** Radio buttons for 'Yes' (selected) and 'No'.
- Use WPS:** Radio buttons for 'Yes' and 'No' (selected).
- SSID:** A text input field containing 'TP-LINK\_662200'.
- Authentication Type:** A dropdown menu set to 'Disabled'.

Figure 4-15

- **SSID:** Wireless network name shared among all points in a wireless network. The SSID must be identical for all devices in the wireless network. It is case-sensitive and must not exceed 32 characters (use any of the characters on the keyboard). Make sure this setting is the same for all stations in your wireless network. Type the desired SSID in the space provided.
- **Authentication Type:** Select an authentication type from the drop-down list, which allows you to configure security features of the wireless LAN interface. Options available are: Disabled, WEP-64Bits, WEP-128Bits, WPA-PSK, WPA2-PSK, and WPA-PSK/WPA2-PSK.



### 1) WEP-64Bits

To configure WEP-64Bits settings, select the WEP-64Bits option from the drop-down list. The menu will change to offer the appropriate settings. WEP-64Bits is a data privacy mechanism based on a 64-bit shared key algorithm, as described in the IEEE 802.11g standard.

The screenshot shows the 'Multiple SSIDs Settings' and 'WEP' configuration sections. In the 'Multiple SSIDs Settings' section, the 'SSID Index' is set to 1, 'Broadcast SSID' is checked (Yes), 'Use WPS' is unchecked (No), the 'SSID' is 'TP-LINK\_662200', and 'Authentication Type' is set to 'WEP-64Bits'. In the 'WEP' section, instructions for key lengths are provided. Under 'WEP 64-bits', 'Key#1' is selected with a radio button and its value is '0x0000000000'.

Figure 4-16

### 2) WEP-128Bits

To configure WEP-128Bits settings, select the WEP-128Bits option from the drop-down list. The menu will change to offer the appropriate settings. 128-bit is stronger than 64-bit.

The screenshot shows the 'Multiple SSIDs Settings' and 'WEP' configuration sections. In the 'Multiple SSIDs Settings' section, the 'Authentication Type' is now set to 'WEP-128Bits'. In the 'WEP' section, 'Key#1' is selected with a radio button and its value is '0x00000000000000000000000000000000'.

Figure 4-17

### 3) WPA-PSK

To configure WPA-PSK settings, select the WPA-PSK option from the drop-down list. The menu will change to offer the appropriate settings. WPA-PSK requires a shared key and does not use a separate server for authentication. PSK keys can be ASCII or Hex type.

The screenshot shows the 'Multiple SSIDs Settings' page. The 'WPA-PSK' tab is selected. The 'SSID Index' is set to 1. 'Broadcast SSID' is checked (Yes). 'Use WPS' is unchecked (No). The 'SSID' field contains 'TP-LINK\_662200'. The 'Authentication Type' is set to 'WPA-PSK'. The 'Encryption' is set to 'TKIP/AES'. The 'Pre-Shared Key' field contains '123456789' and has a note '(8~63 ASCII characters or 64 hexadecimal characters)'.

Figure 4-18

- **Encryption:** Select the encryption you want to use: TKIP/AES, TKIP or AES (AES is an encryption method stronger than TKIP).
  - **TKIP (Temporal Key Integrity Protocol)** - a wireless encryption protocol that provides dynamic encryption keys for each packet transmitted.
  - **AES (Advanced Encryption Standard)** - A security method that uses symmetric 128-bit block data encryption.
- **Pre-Shared Key:** Enter the key shared by the modem router and your other network devices. It must have 8-63 ASCII characters or 64 Hexadecimal digits.

#### 4) WPA2-PSK

To configure WPA2-PSK settings, select the WPA2-PSK option from the drop-down list. The menu will change to offer the appropriate settings. WPA2-PSK requires a shared key and does not use a separate server for authentication. PSK keys can be ASCII or Hex type.

The screenshot shows the 'Multiple SSIDs Settings' page. The 'WPA2-PSK' tab is selected. The 'SSID Index' is set to 1. 'Broadcast SSID' is checked (Yes). 'Use WPS' is unchecked (No). The 'SSID' field contains 'TP-LINK\_662200'. The 'Authentication Type' is set to 'WPA2-PSK'. The 'Encryption' is set to 'TKIP/AES'. The 'Pre-Shared Key' field contains '123456789' and has a note '(8~63 ASCII characters or 64 hexadecimal characters)'.

Figure 4-19

#### 5) WPA-PSK/WPA2-PSK

To configure WPA-PSK/WPA2-PSK settings, select the WPA-PSK/WPA2-PSK option from the drop-down list. The menu will change to offer the appropriate settings. WPA-PSK/WPA2-PSK requires a shared key and does not use a separate server for authentication. PSK keys can be ASCII or Hex type. WPA-PSK/WPA2-PSK is more flexible than WPA-PSK or WPA2-PSK.

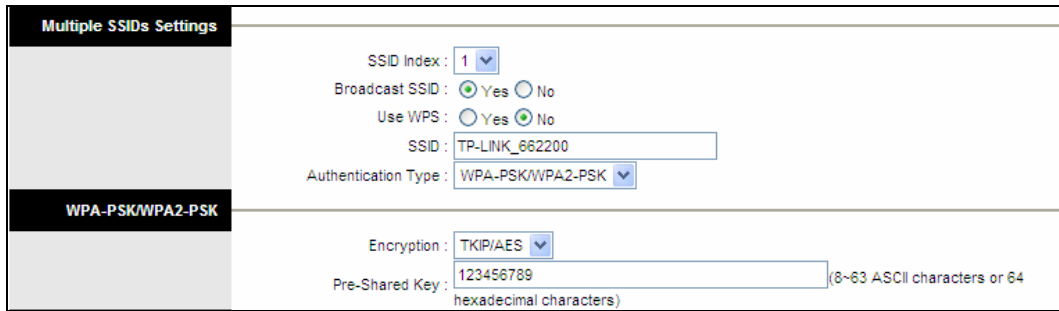

Figure 4-20

#### 4.3.3.1 WPS Settings

➤ **WPS Settings:** WPS can help you to add a new wireless device to an existing network quickly. This section will guide you how to use WPS function.

- **WPS state:** Display the current WPS state.
- **WPS mode:** If the wireless adapter supports Wi-Fi Protected Setup (WPS), you can establish a wireless connection between wireless adapter and modem router using either Push Button Configuration (PBC) method or PIN method, please select the one you want.
- **WPS progress:** Show the current WPS progress.
- **Reset to OOB:** Use this button to reset the WPS state to “unconfigured”, so that a new key will be created when using WPS function next time.

##### 1) PBC

If the wireless adapter supports Wi-Fi Protected Setup and the Push Button Configuration (PBC) method, you can add it to the network by PBC with the following two methods. Click **PBC**, you will see the screen as shown below.

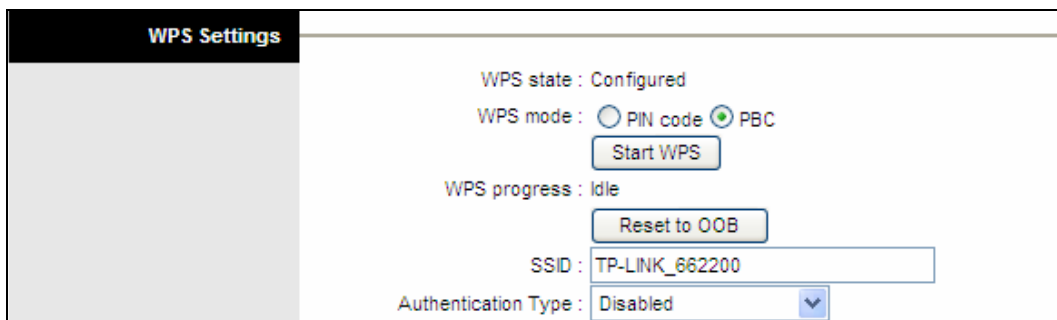
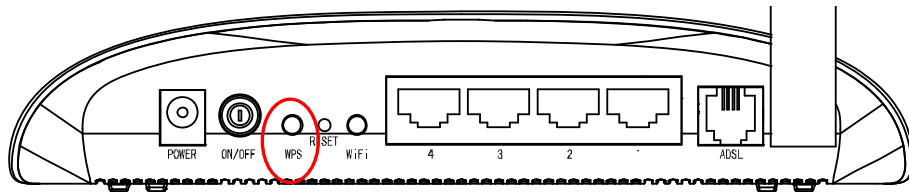

Figure 4-21

##### Method One:

**Step 1:** Press the WPS button on the back panel of the modem router or click **Start WPS** button in Figure 4-21.



**Step 2:** Press and hold the WPS button of the adapter directly for 2 or 3 seconds.



**Step 3:** Wait for a while until the next screen appears. Click **Finish** to complete the WPS configuration.

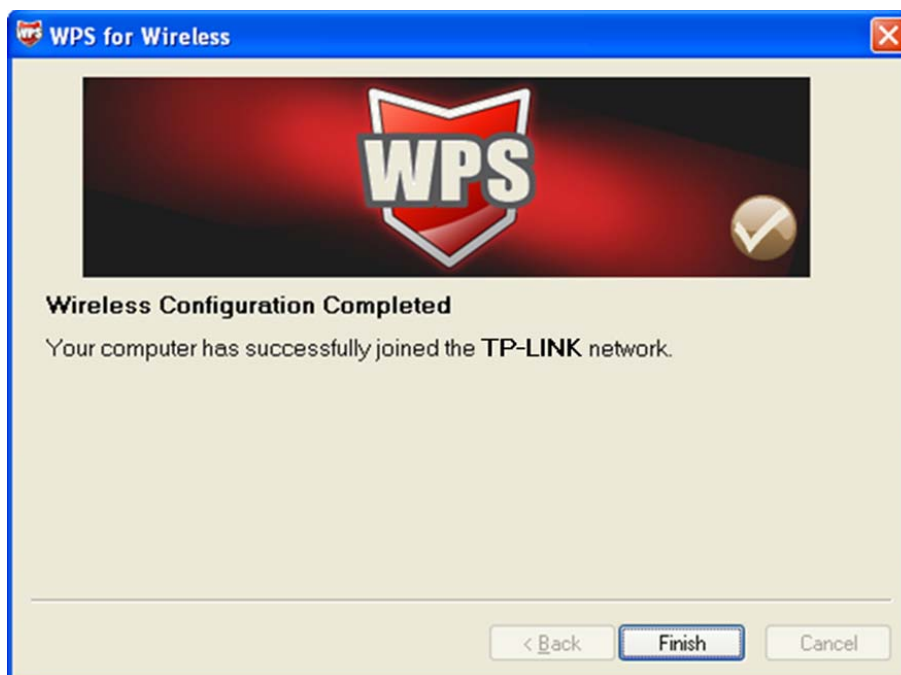

The WPS Configuration Screen of Wireless Adapter

**Method Two:**

**Step 1:** Press the WPS button on the front panel of the modem router or click **Start WPS** button in Figure 4-21.

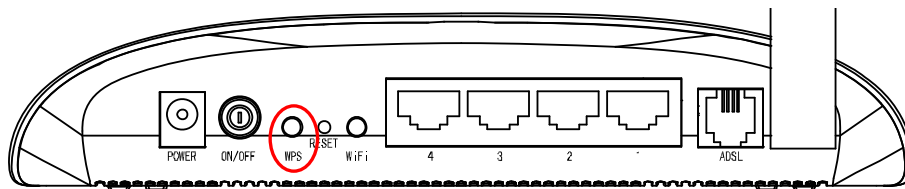

**Step 2:** For the configuration of the wireless adapter, please choose “**Push the button on my access point**” in the configuration utility of the WPS as below, and click **Next**.

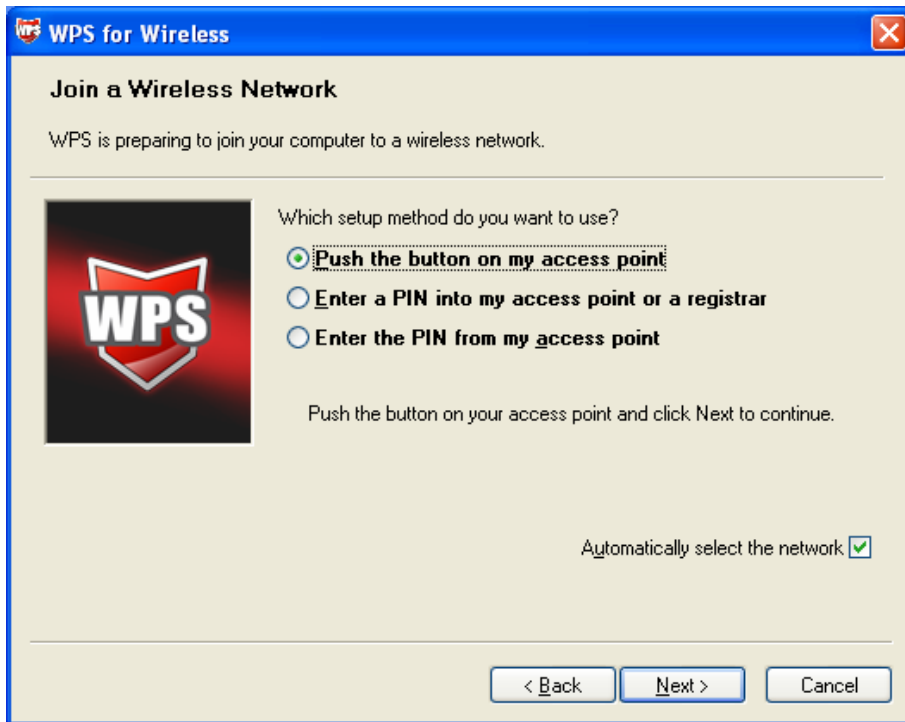

The WPS Configuration Screen of Wireless Adapter

**Step 3:** Wait for a while until the next screen appears. Click **Finish** to complete the WPS configuration.

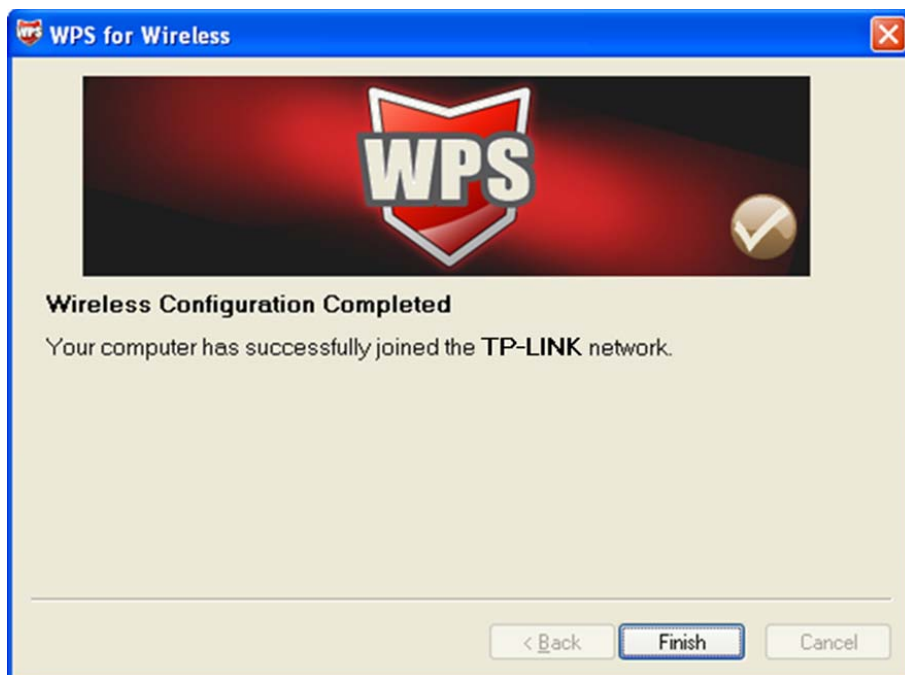

The WPS Configuration Screen of Wireless Adapter

## 2) PIN code

If the wireless adapter supports Wi-Fi Protected Setup and the PIN method, you can add it to the network by PIN with the following two methods. Click **PIN code**, you will see the screen as shown below.

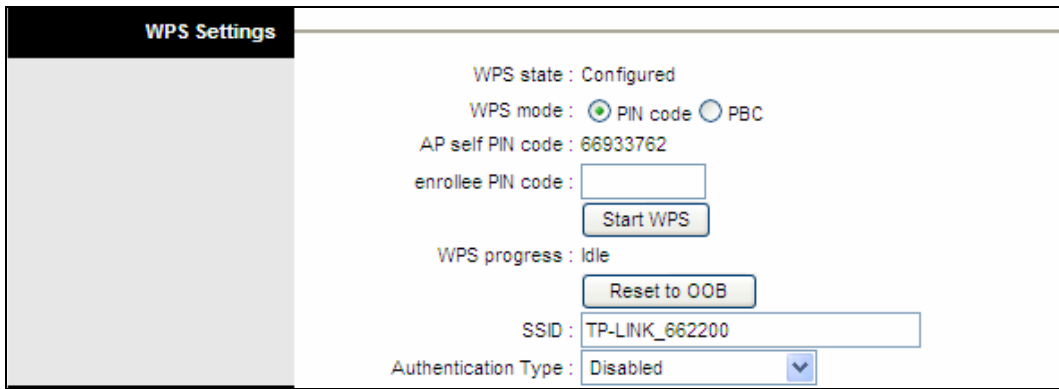

Figure 4-22

**Method One:** Enter the PIN into my modem router

Step 1: For the configuration of the wireless adapter, please choose “**Enter a PIN into my access point or a registrar**” in the configuration utility of the WPS, and get the PIN code on the screen as below, then click **Next**.



The WPS Configuration Screen of Wireless Adapter

Step 2: For the modem router, keep **PIN code** selected and enter the PIN code of the wireless adapter in the field after **enrollee PIN code** as shown below. Then click **Start WPS**.

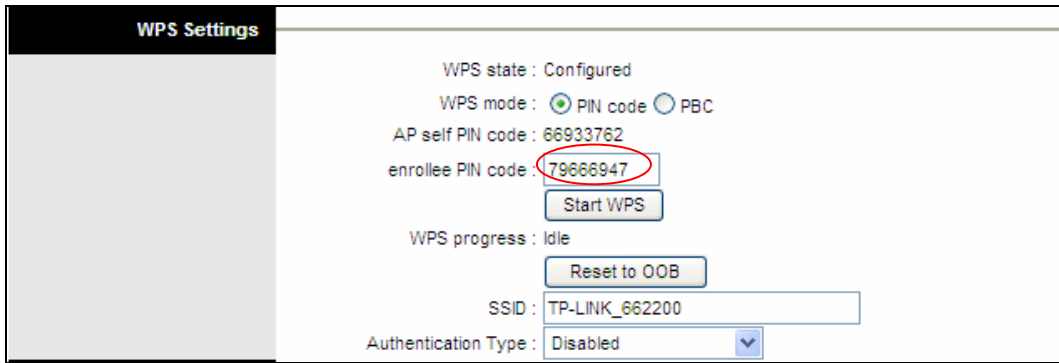
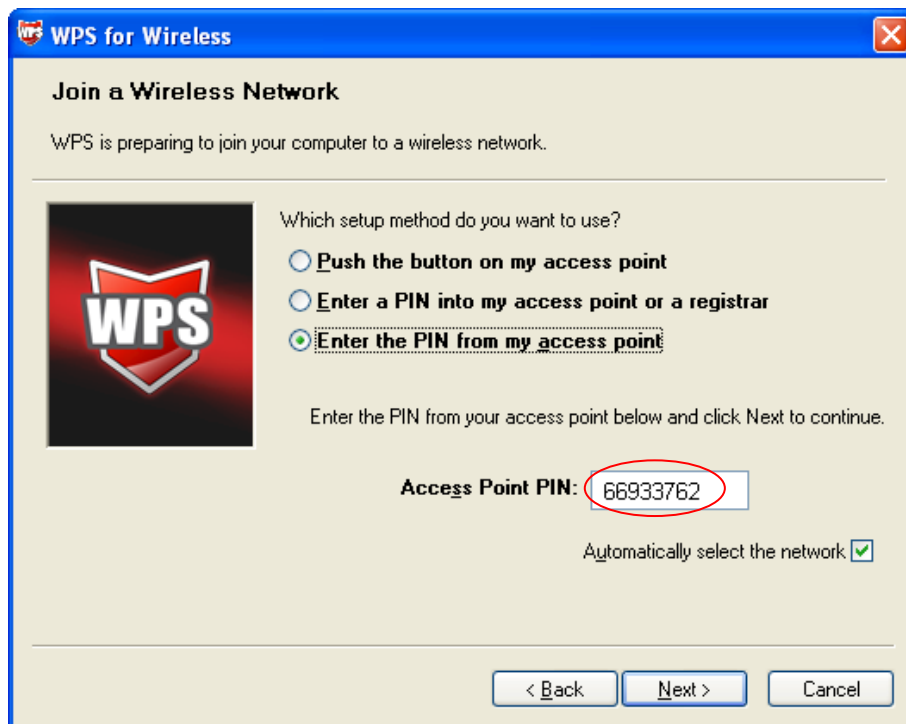

Figure 4-23

**Method Two:** Enter the PIN from my modem router

- Step 1: Get the Current PIN code of the modem router from **AP self PIN code** in Figure 4-23 (each modem router has its unique PIN code. Here takes the PIN code 66933762 of this modem router for example).
- Step 2: For the configuration of the wireless adapter, please choose “**Enter a PIN from my access point**” in the configuration utility of the WPS as below, and enter the PIN code of the modem router into the field after “**Access Point PIN**”. Then click **Next**.



The WPS Configuration Screen of Wireless Adapter

**Note:**

The default PIN code of the modem router can be found in its label or the WPS configuration screen as Figure 4-23.

- **SSID:** Wireless network name shared among all points in a wireless network. The SSID must be identical for all devices in the wireless network. It is case-sensitive and must not exceed 32 characters (use any of the characters on the keyboard). Make sure this setting

is the same for all stations in your wireless network. Type the desired SSID in the space provided.

- **Authentication Type:** Select an authentication type from the drop-down list, which allows you to configure security features of the wireless LAN interface. Options available are: Disabled, WEP-64Bits, WEP-128Bits, WPA-PSK, WPA2-PSK, and WPA-PSK/WPA2-PSK.
- **WDS Settings:** Select On/Off to enable/disable WDS. With this function enabled, the modem router can bridge two or more WLANs.
  - **MAC Address:** Enter the MAC Address you wish to bridge in the field.
- **Wireless MAC Address Filter:** Wireless access can be filtered by using the MAC addresses of the wireless devices transmitting within your network's RADIUS.
  - **Active:** If you wish to filter users by MAC Address, select "Activated", and "Deactivated" for don't.
  - **Action:** To filter wireless users by MAC Address, select "Allow Association" or "Deny Association" the follow Wireless LAN station(s) association.
  - **MAC Address:** Enter the MAC Address you wish to filter in the field.

 **Note:**

For most users, it is recommended to use the default Wireless LAN Performance settings. Any changes made to these settings may adversely affect your wireless network. Under certain circumstances, changes may benefit performance. Carefully consider and evaluate any changes to these wireless settings.

## 4.4 Advanced Setup

Choose "Advanced Setup", you can see the next submenus:



Figure 4-24

Click any of them, and you will be able to configure the corresponding function.

### 4.4.1 Firewall

Choose "Advanced Setup→Firewall" menu, and you will see the next screen (shown in Figure 4-25).



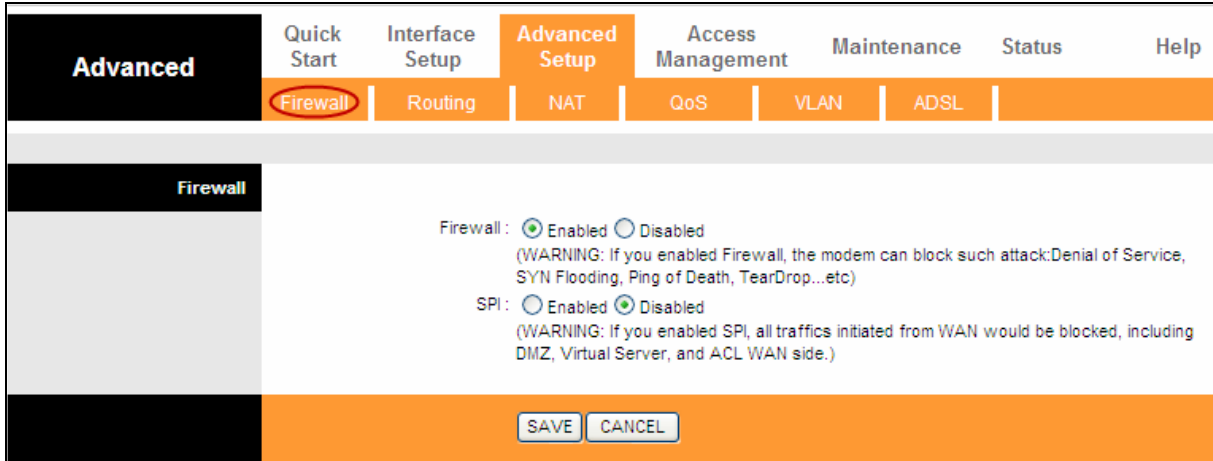

Figure 4-25

- **Firewall:** Select this option can automatically detect and block Denial of Service (DoS) attacks, such as Ping of Death, SYN Flood, Port Scan and Land Attack.
- **SPI:** If you enable SPI, all traffics initiated from WAN would be blocked, including DMZ, Virtual Server, and ACL WAN side.

#### 4.4.2 Routing

Choose “**Advanced Setup**→**Routing**” menu, and you will see the routing information in the next screen (shown in Figure 4-26).

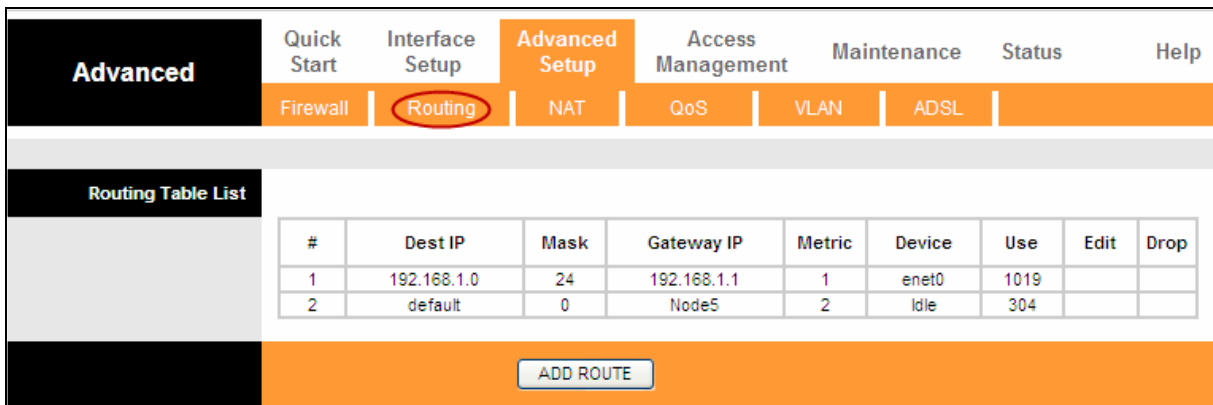

Figure 4-26

Click **ADD ROUTE** button to add a new route in the next screen (shown in Figure 4-27).

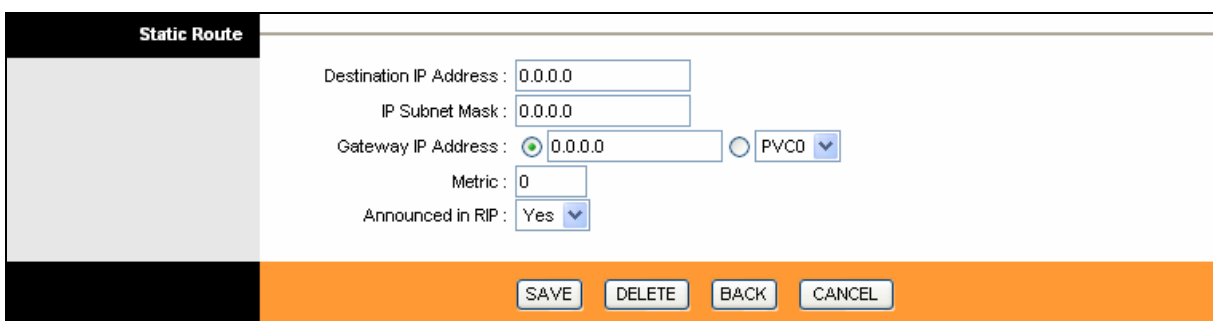

Figure 4-27

- **Destination IP Address:** This parameter specifies the IP network address of the final destination.
- **IP Subnet Mask:** Enter the subnet mask for this destination.
- **Gateway IP Address:** Enter the IP address of the gateway. The gateway is an immediate neighbor of your ADSL modem router that will forward the packet to the destination. On the LAN, the gateway must be a router on the same segment as your Router; over Internet (WAN), the gateway must be the IP address of one of the remote nodes.
- **Metric:** Metric represents the "cost" of transmission for routing purposes. IP Routing uses hop count as the measurement of cost, with a minimum of 1 for directly connected networks. Enter a number that approximates the cost for this link. The number need not to be precise, but it must between 1 and 15. In practice, 2 or 3 is usually a good number.
- **Announced in RIP:** This parameter determines if the ADSL router will include the route to this remote node in its RIP broadcasts. If set to Yes, the route to this remote node will be propagated to other hosts through RIP broadcasts. If No, this route is kept private and is not included in RIP broadcasts.

### 4.4.3 NAT

Choose “**Advanced Setup**→**NAT**” menu, you can set up the NAT (Network Address Translation) function for the modem router (shown in Figure 4-28).

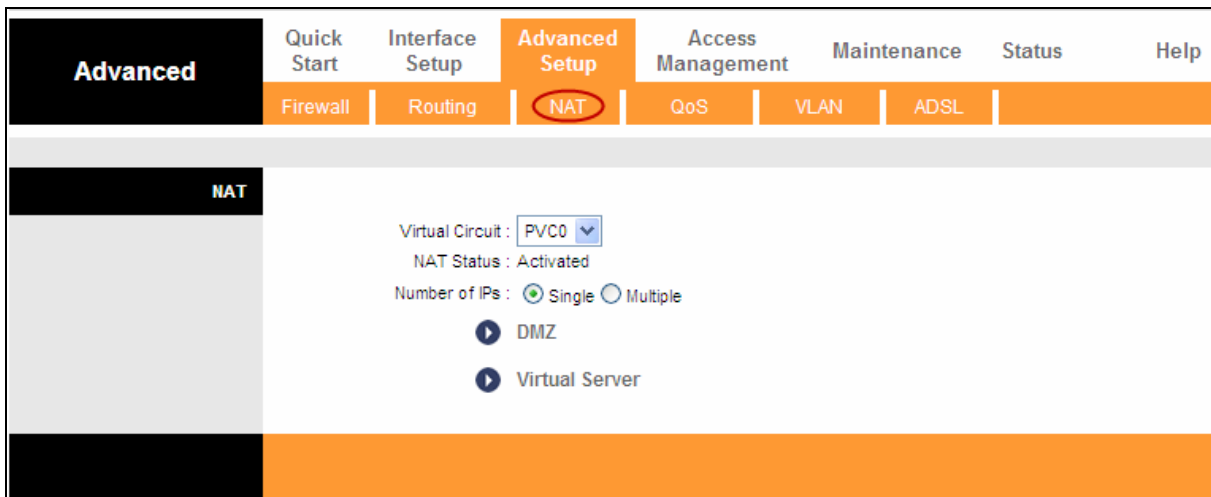

Figure 4-28

- **Virtual Circuit:** Enter Virtual Circuit Index that you plan to setup for the NAT function.
- **NAT Status:** This field shows the current status of the NAT function for the current VC. You can go to the previous screen (shown in Figure 4-6) to activate the function.
- **Number of IPs;** This field is to specify how many IPs are provided by your ISP for current VC. It can be single IP or multiple IPs. We select Multiple to explain.

 **Note:**

For VCs with single IP, they share the same DMZ and Virtual servers; for VCs with multiple IPs, each VC can set DMZ and Virtual servers. Furthermore, for VCs with multiple IPs, they can define the Address Mapping rules; for VCs with single IP, since they have only one IP, there is no need to individually define the Address Mapping rule.

#### 4.4.3.1 DMZ

Choose “**Advanced Setup**→**NAT**→**DMZ**” in Figure 4-28, you can configure the DMZ host in the next screen. A DMZ (demilitarized zone) is a host between a private local network and the outside public network. It prevents outside users from getting direct access to a server that has company data. Users of the public network outside the company can access to the DMZ host.

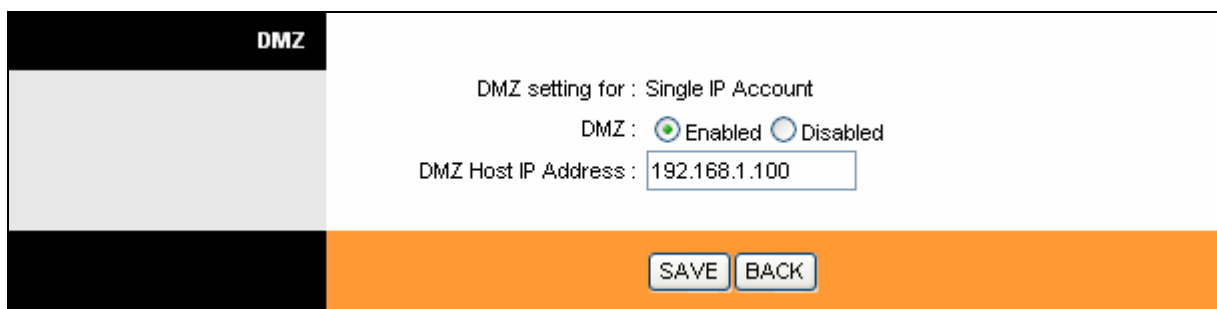

Figure 4-29

- **DMZ Host IP Address:** Enter the specified IP Address for DMZ host on the LAN side.

#### 4.4.3.2 Virtual Server

Choose “**Advanced Setup**→**NAT**→**Virtual Server**” in Figure 4-28, you can configure the Virtual Server in the next screen.

The Virtual Server is the server or server(s) behind NAT (on the LAN), for example, Web server or FTP server, that you can make visible to the outside world even though NAT makes your whole inside network appear as a single machine to the outside world.

Virtual Server					
Virtual Server for: Single IP Account					
Rule Index:	3				
Application:	FTP FTP				
Protocol:	ALL				
Start Port Number:	21				
End Port Number:	21				
Local IP Address:	192.168.1.102				
Virtual Server Listing					
Rule	Application	Protocol	Start Port	End Port	Local IP Address
1	FTP	ALL	21	21	192.168.1.100
2	HTTP_Server	ALL	80	80	192.168.1.101

Figure 4-30

- **Rule Index:** The Virtual server rule index for this VC. You can specify 10 rules in maximum. All the VCs with single IP will use the same Virtual Server rules.
- **Application:** The Virtual servers can be used for setting up public services on your LAN.
- **Protocol:** The protocol used for this application.
- **Start & End port number:** Enter the specific Start and End Port number you want to forward. If it is one port only, you can enter the End port number the same as Start port number. For example, if you want to set the FTP Virtual server, you can set the start and end port number to 21.
- **Local IP Address:** Enter the IP Address for the Virtual Server in LAN side.
- **Virtual Server Listing:** This displays the information about the Virtual Servers you establish.

#### To add a virtual server entry:

**Step 1:** Select the “Virtual Circuit” and select “Virtual Server”.

#### Note:

For VCs with single IP, select **Single**; For VCs with multiple IPs, select **Multiple** for the option.

**Step 2:** Select the Rule index for the rule as shown in Figure 4-30.

**Step 3:** Select the application you want from drop-down list, then the protocol and port number will be added to the corresponding field automatically, you only need to configure the IP address for the virtual server; If the application list does not contain the service that you want, please configure the Port number, IP Address and Protocol manually.

**Step 4:** After that, click **SAVE** to make the entry take effect.

#### Other operations for the entries as shown in Figure 4-30:

Enter the index of assigned entry, and click the **DELETE** button to delete the entry.

Click the **BACK** button to return to the previous screen.

Click the **CANCEL** button to cancel the configuration which is made just now.

#### 4.4.3.3 IP Address Mapping

Select **Multiple** for **numbers of IPs** in Figure 4-28, and choose “**Advanced Setup→NAT→IP Address Mapping(for Multiple IP Service)**”. You can configure the Address Mapping Rule in the next screen. The IP Address Mapping is for those VCs that configured with multiple IPs. The IP Address Mapping rule is per-VC based (only for Multiple IPs' VCs).

Rule	Type	Local Start IP	Local End IP	Public Start IP	Public End IP
1	M-M Ov	0.0.0.0	255.255.255.255	61.141.228.32	61.141.228.254

Figure 4-31

- **Rule Index:** Select the Virtual server rule index for this VC. You can specify 8 rules in maximum.
- **Rule Typ:** There are four types: one-to-one, Many-to-One, Many-to-Many Overload and Many-to-Many No-overload.
- **Local Start & End IP:** Enter the local IP Address you plan to map to. Local Start IP is the starting local IP address and Local End IP is the ending local IP address. If the rule is for all local IPs, then the Start IP is 0.0.0.0 and the End IP is 255.255.255.255.
- **Public Start & End IP:** Enter the public IP Address you want to do NAT. Public Start IP is the starting public IP address and Public End IP is the ending public IP address. If you have a dynamic IP, enter 0.0.0.0 as the Public Start IP.
- **Address Mapping List:** This displays the information about the Mapping addresses.

**To add a mapping rule:**

**Step 1:** Select the “Virtual Circuit” and Multiple for the “Number of IPs”. Then select the tab **IP Address Mapping** (shown in Figure 4-28).

**Note:**

**IP Address Mapping** is only available for VCs with Multiple IPs.

**Step 2:** Select the Rule index for the rule as shown in Figure 4-31.

**Step 3:** Select the rule type you want from the drop-down list.

**Step 4:** Enter the local and public IP addresses in the corresponding fields.

**Step 5:** After that, click **SAVE** to make the entry take effect.

**Other operations for the entries as shown in Figure 4-31:**

Select the index of assigned entry, and click the **DELETE** button to delete the entry.

Click the **BACK** button to return to the previous screen.

Click the **CANCEL** button to cancel the configuration which is made just now.

#### 4.4.4 QoS

Choose “**Advanced Setup**→**QoS**”, you can configure the QoS in the next screen. QoS helps to prioritize data as it enters your modem router. By attaching special identification marks or headers to incoming packets, QoS determines which queue the packets enter, based priority. This is useful when there are certain types of data you want to give higher priority, such as voice data packets give higher priority than Web data packets. This option will provide better service of selected network traffic over various technologies.

Advanced	Quick Start	Interface Setup	Advanced Setup	Access Management	Maintenance	Status	Help
	Firewall	Routing	NAT	QoS	VLAN	ADSL	
<b>Quality of Service</b>							
QoS: <input checked="" type="radio"/> Activated <input type="radio"/> Deactivated Summary: <input type="button" value="QoS Settings Summary"/>							
<b>Rule</b>	Rule Index: 1						
	Active: <input type="radio"/> Activated <input checked="" type="radio"/> Deactivated						
	Application: <input type="text"/>						
	Physical Ports: <input type="checkbox"/> WLAN <input type="checkbox"/> Enet1 <input type="checkbox"/> Enet2 <input type="checkbox"/> Enet3 <input type="checkbox"/> Enet4						
	Destination MAC: <input type="text"/>						
	IP: <input type="text"/>						
	Mask: <input type="text"/>						
	Port Range: <input type="text"/> ~ <input type="text"/>						
	Source MAC: <input type="text"/>						
	IP: <input type="text"/>						
	Mask: <input type="text"/>						
	Port Range: <input type="text"/> ~ <input type="text"/>						
	Protocol ID: <input type="text"/>						
	Vlan ID Range: <input type="text"/> ~ <input type="text"/>						
	IPP/DS Field: <input type="radio"/> IPP/TOS <input checked="" type="radio"/> DSCP						
<b>Action</b>	IP Precedence Range: <input type="text"/> ~ <input type="text"/>						
	Type of Service: <input type="text"/>						
	DSCP Range: <input type="text"/> ~ <input type="text"/> (Value Range: 0 ~ 63)						
	802.1p: <input type="text"/> ~ <input type="text"/>						
	IPP/DS Field: <input type="radio"/> IPP/TOS <input checked="" type="radio"/> DSCP						
	IP Precedence Remarking: <input type="text"/>						
	Type of Service Remarking: <input type="text"/>						
	DSCP Remarking: <input type="text"/> (Value Range: 0 ~ 63)						
	802.1p Remarking: <input type="text"/>						
	Queue #: <input type="text"/>						
<input type="button" value="ADD"/> <input type="button" value="DELETE"/> <input type="button" value="CANCEL"/>							

Figure 4-32

- **QoS:** Select this option to Activate/Deactivate the IP QoS on different types (IP ToS and DiffServ).
- **Summary:** Click the button to view the configurations of QoS.
- **Rule:** Configure the rules for QoS. If the traffic complies with the rule, then the modem router will take the corresponding action to deal with it.
  - **Rule Index:** Select the index for the rule you want to configure.
  - **Active:** Activate the rule. The rule can take effect only when it is activated.
  - **Application:** Select the application that the rule aimed at.

- **Physical Ports:** Select the port whose traffic flow are controlled by the rule.
- **Destination MAC & IP & Mask & Port Range:** Enter the IP information about the Destination host for the rule.
- **Source MAC & IP & Mask & Port Range:** Enter the IP information about the Source host for the rule.
- **Protocol ID:** Select one among TCP/UDP, TCP, UDP or ICMP protocols for the application.
- **Vlan ID Range:** Enter the Vlan range, and the rule will be effective to the selected Vlans.
- **IPP/DS Field:** Select the type of the action to assign the priority.

When you select IPP/TOS, you can assign the priority via IP information. IP QoS function is intended to deliver guaranteed as well as differentiated Internet services by giving network resource and usage control to the Network operator.

- **IP Precedence Range:** Enter the IP precedence range that the modem router takes to differentiate the traffic.
- **Type of Service:** Select the type of service that the modem router takes to deal with the traffic.
- **802.1p:** Select the priority range for the rule.

When you select DSCP, you can assign the priority via DHCP (the header of IP group). It maps the IP group into corresponding service class.

- **DSCP Range:** Enter the DSCP range to differentiate the traffic.
  - **802.1p:** Select the priority range for the rule.
- **Action:** Configure the action that the modem router takes to deal with the traffic which accord with the rule.
- **IPP/DS Field:** Select the type for the action.
  - **IP Precedence Remarking:** Select the number to remark the priority for IP precedence.
  - **Type of Service Remarking:** Select the type to remark the service.
  - **DSCP Remarking:** Enter the number to remark the DSCP priority.
  - **802.1p Remarking:** Select the type to remark the 802.1p priority.
  - **Queue:** Select the priority type for the action.

#### 4.4.5 VLAN

Choose “**Advanced Setup**→**VLAN**”, you can activate the VLAN function in the next screen.



Virtual LAN (VLAN) is a group of devices on one or more LANs that are configured so that they can communicate as if they were attached to the same LAN, when in fact they are located on a number of different LAN segments. Because VLANs are based on logical instead of physical connections, it is very flexible for user/host management, bandwidth allocation and resource optimization. There are two types of VLAN as follows:

Port-Based VLAN: Each physical switch port is configured with an access list specifying membership in a set of VLANs.

ATM VLAN: Using LAN Emulation (LANE) protocol to map Ethernet packets into ATM cells and deliver them to their destination by converting an Ethernet MAC address into an ATM address.

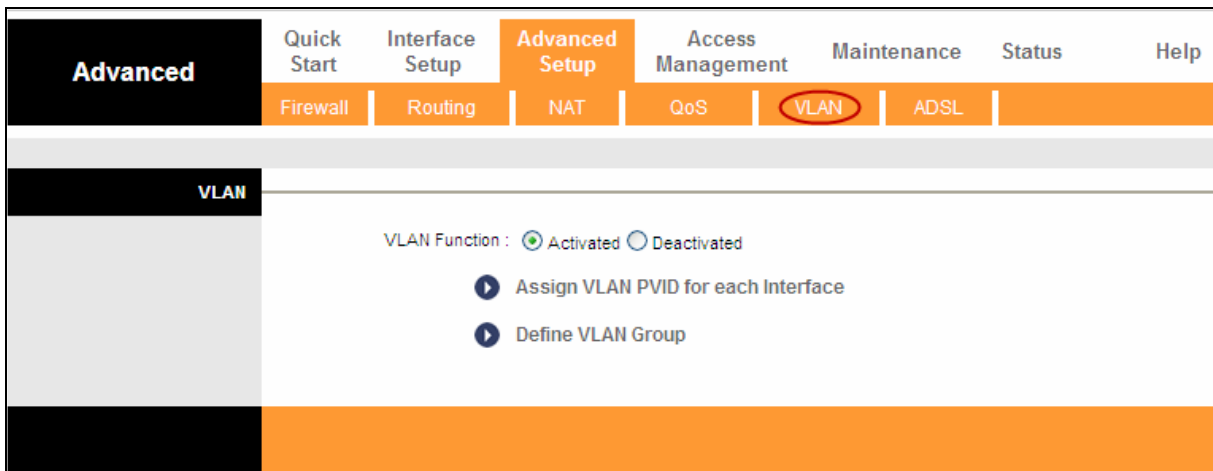

Figure 4-33

### 1) Assign VLAN PVID for each Interface

Click **Assign VLAN PVID for each Interface** in Figure 4-33, you can assign the PVID for each interface in the next screen (shown in Figure 4-34).

**PVID Assign**

ATM VC #0 : PVID

VC #1 : PVID

VC #2 : PVID

VC #3 : PVID

VC #4 : PVID

VC #5 : PVID

VC #6 : PVID

VC #7 : PVID

Ethernet Port #1 : PVID

Port #2 : PVID

Port #3 : PVID

Port #4 : PVID

Wireless LAN : PVID

Figure 4-34

- **PVID:** Each physical port has a default VID called PVID (Port VID). PVID is assigned to untagged frames or priority tagged frames (frames with null (0) VID) received on this port.

## 2) Define VLAN Group

Click **Define VLAN Group** in Figure 4-33, you can define VLAN groups in the next screen (shown in Figure 4-35).

VLAN Group Setting

VLAN Index:

Active:  Yes  No

VLAN ID:  (Decimal)

ATM VCs:

Tagged	<input type="checkbox"/>	<input type="checkbox"/>	<input type="checkbox"/>	<input type="checkbox"/>	<input type="checkbox"/>	<input type="checkbox"/>	<input type="checkbox"/>
Port #	<input checked="" type="checkbox"/>	<input checked="" type="checkbox"/>	<input checked="" type="checkbox"/>	<input checked="" type="checkbox"/>	<input checked="" type="checkbox"/>	<input checked="" type="checkbox"/>	<input checked="" type="checkbox"/>
	0	1	2	3	4	5	6

Ethernet:

Tagged	<input type="checkbox"/>	<input type="checkbox"/>	<input type="checkbox"/>	<input type="checkbox"/>
Port #	<input checked="" type="checkbox"/>	<input checked="" type="checkbox"/>	<input checked="" type="checkbox"/>	<input checked="" type="checkbox"/>
	1	2	3	4

Wireless LAN:

Tagged	<input type="checkbox"/>
Port #	<input checked="" type="checkbox"/>
	0

**VLAN Group Summary**

Group	Active	ID	VLAN Group Ports	VLAN Tagged Ports
1	Yes	1	e4,e3,e2,e1,w0,p0,p1,p2,p3,p4,p5,p6,p7	

p:pvc, e:ethernet, and w:wlan

Figure 4-35

- **VLAN Index:** Select the VLAN index for this VC. You can specify 8 groups in maximum.
- **VLAN ID:** This indicates the VLAN group.
- **ATM VCs:** Select the ATM VCs as members of VLAN, and if you leave the Tagged blank, the tag in frames will be deleted when transmitted from the VC.
- **Ethernet:** Select the Ethernet port as a member of VLAN.
- **Wireless LAN:** Select the wireless LAN port as a member of VLAN, and if you leave the Tagged blank, the tag in frames will be deleted when transmitted from the port.
- **VLAN Group Summary:** This displays the information about the VLAN Groups.

#### 4.4.6 ADSL

Choose “**Advanced Setup**→**ADSL**”, you can select the ADSL Type and ADSL Mode in the next screen. The ADSL feature can be selected when you meet the physical connection problem. Please check the proper settings with your Internet service provider.

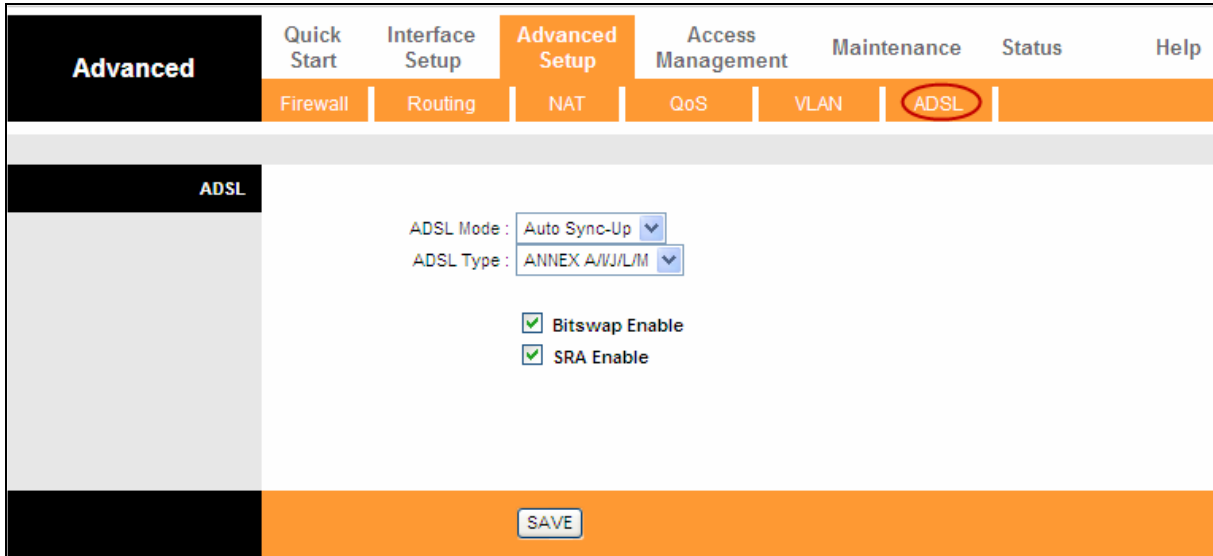

Figure 4-36

- **ADSL Mode:** Select the ADSL operation mode which your ADSL connection uses.
- **ADSL Type:** Select the ADSL operation type which your ADSL connection uses.

## 4.5 Access Management

Choose “**Access Management**”, you can see the next submenus:



Figure 4-37

Click any of them, and you will be able to configure the corresponding function.

### 4.5.1 ACL

Choose “**Access Management**→**ACL**”, you can see the next screen (shown in Figure 4-38). You can specify the client to access the ADSL modem router once setting his IP as a Secure IP Address through selected applications.

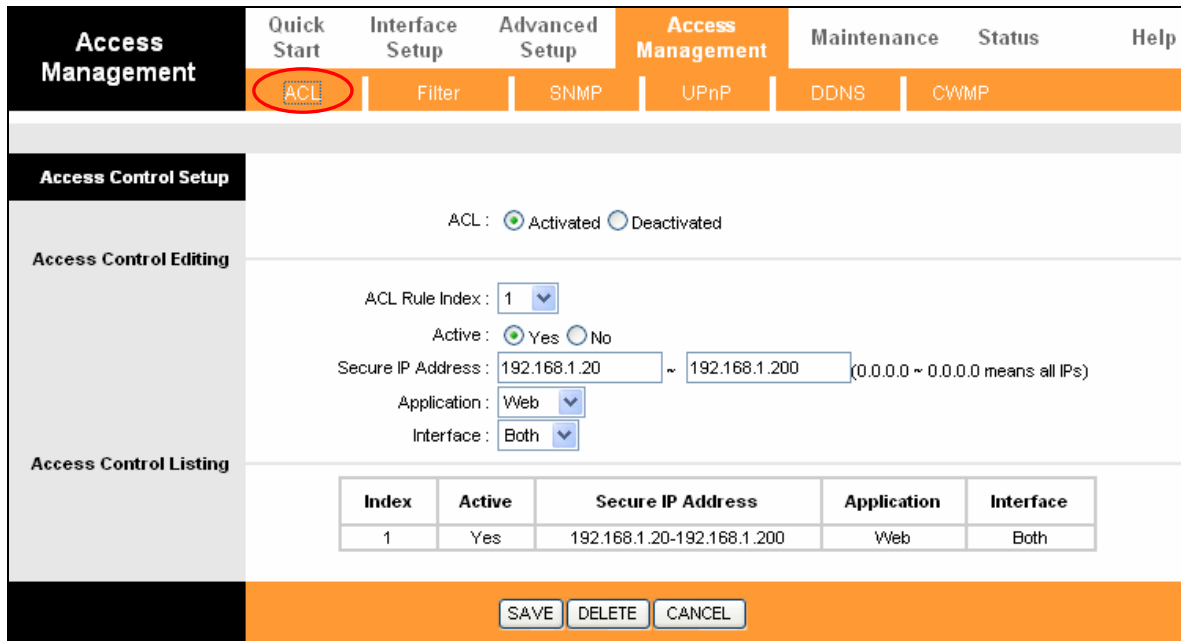

Figure 4-38

- **ACL:** If **Activated**, the IP addresses which are contained in the Access Control List can access to the modem router. If **Deactivated**, all IP addresses can access to the modem router.
- **ACL Rule Index:** Select the ACL rule index for the entry.
- **Active:** Enable the ACL rule.
- **Secure IP Address:** Select the IP addresses which are permitted to access to the modem router remotely. With the default IP 0.0.0.0, any client would be allowed to remotely access the ADSL modem router.
- **Application:** Select the application for the ACL rule, and then you can access the modem router through it.
- **Interface:** Select the interface for access: LAN, WAN or Both.
- **Access Control of Listing:** This displays the information about the ACL Rules.

## 4.5.2 Filter

Choose “**Access Management**→**Filter**”, you can see the Filter screen (the default is IP/MAC Filter screen shown in Figure 4-39 ). The filtering feature includes IP/MAC Filter, Application Filter, and URL Filter. The feature makes it possible for administrators to control user's access to the Internet, protect the networks.

### 4.5.2.1 IP Filter

Select **IP/MAC Filter** as the Filter type, and select **IP** as the Rule type (shown in Figure 4-39), then you can configure the filter rules based on IP address. The filtering includes **Outgoing** and **Incoming**, the detailed descriptions are provided below.

**Filter**

**Filter Type**

Filter Type Selection: IP / MAC Filter

**IP / MAC Filter Set Editing**

IP / MAC Filter Set Index: 1  
 Interface: PVC0  
 Direction: Both

**IP / MAC Filter Rule Editing**

IP / MAC Filter Rule Index: 3  
 Rule Type: IP  
 Active:  Yes  No

Source IP Address: 192.168.1.8 (0.0.0.0 means Don't care)  
 Subnet Mask: 255.255.255.255  
 Port Number: 0 (0 means Don't care)

Destination IP Address: 202.96.134.12 (0.0.0.0 means Don't care)  
 Subnet Mask: 255.255.255.255  
 Port Number: 0 (0 means Don't care)

Protocol: TCP  
 Rule Unmatched: Forward

**IP / MAC Filter Listing**

IP / MAC Filter Set Index	1	Interface	PVC0	Direction	Both		
#	Active	Src Address.Mask	Dest IP/Mask	Src Port	Dest Port	Protocol	Unmatched
1	Yes	192.168.1.7/ 255.255.255.255	0.0.0.0/ 0.0.0.0	0	25	TCP	Next
2	Yes	192.168.1.7/ 255.255.255.255	0.0.0.0/ 0.0.0.0	0	110	TCP	Forward
3	Yes	192.168.1.8/ 255.255.255.255	202.96.134.12/ 255.255.255.255	0	0	TCP	Forward
4	-	-	-	-	-	-	-
5	-	-	-	-	-	-	-
6	-	-	-	-	-	-	-

SAVE DELETE CANCEL

Figure 4-39

- **Filter Type Selection:** Select the filter type for the configuration below.
- **IP/MAC Filter Set Index:** Select the Set index for the IP Filter entry. This index can match with six IP / MAC Filter Rule Indexes.
- **Interface:** Select the interface for the entry.

**Note:**

If select PVC0~PVC7 as an interface, the filter will match the IP traffic of WAN port with specified IPs (Source IP Address and Destination IP Address). If select LAN as an interface, the filter will match the IP traffic of LAN port with specified IPs.

- **Direction:** Select the direction for this IP Filter rule. There are three filtering directions: Both, Incoming, Outgoing.

 **Note:**

Incoming means that IP traffic which is coming into the modem router, and the Outgoing means that IP traffic which is going out the modem router.

- **IP/MAC Filter Rule Index:** Select the Rule index for the IP Filter entry.

 **Note:**

You should set the **IP/MAC Filter Set Index** and **IP/MAC Filter Rule Index** together to appoint the address (shown in the Filter List) for the IP Filter rule. For example, (1, 2), it means the rule will be shown in the row 2 IP/MAC Filter Set Index 1.

- **Rule Type:** For IP Filter, please select IP here.
- **Active:** Select “Yes” to make the rule to take effect.
- **Source IP Address:** Enter the source IP address for the rule. You can enter 0.0.0.0; it means that all IP addresses are controlled by the rule.
- **Destination IP Address:** Enter the destination IP address for the rule. You can enter 0.0.0.0, it means that all IP addresses are controlled by the rule. The set of Subnet Mask and Port Number are same as Source IP Address.
- **Subnet Mask:** Enter the Subnet Mask for the rule.
- **Port Number:** Enter the Port Number for the rule. You can enter 0, which means that all ports are controlled by the rule.
- **Protocol:** Select the protocol: **TCP**, **UDP** or **ICMP** for the filter rule.
- **Rule Unmatched:** If the current rule can not match, and you select **Forward**, the modem router will skip the rule and transmit directly. If you select **Next**, the modem router will find the next filter rule (show in Filter list) to match.
- **IP/MAC Filter Listing:** This displays the information about the IP Filter rules.

**To add an IP Address filtering entry:**

**For example:** If you desire to block E-mail received and sent by the IP address 192.168.1.7 on your local network; And wish to make the PCs with IP address 192.168.1.8 unable to visit the website of IP address 202.96.134.12, while other PCs have no limit. You can configure the rules as follows. Presume the rules are both aimed at the interface PVC0, and their indexes are (1, 1), (1, 2) and (1, 3).

**Step 1:** Select the “IP/MAC Filter” as the Filter Type Selection (show in Figure 4-39).

Filter Type Selection : IP / MAC Filter

Select the “IP” as the Rule Type on the Filter screen, then you can configure the specific rule for the example.

Rule Type : IP

**Step 2:** Select the **IP/MAC Filter Set Index** and **IP/MAC Filter Rule Index** for the rule, then select the Interface “PVC0”, and select the Direction “Both” for the first rule.

IP / MAC Filter Set Index : 1  
 Interface : PVC0  
 Direction : Both

---

IP / MAC Filter Rule Index : 1  
 Rule Type : IP  
 Active :  Yes  No

**Note:**

If you want to make the rule take effect, please select **Yes** to activate the rule.

**Step 3:** Enter the “Source IP Address”, “Destination IP Address”, “Subnet Mask” and “Port Number” in the corresponding field.

Source IP Address : 192.168.1.7 (0.0.0.0 means Don't care)  
 Subnet Mask : 255.255.255.255  
 Port Number : 0 (0 means Don't care)

---

Destination IP Address : 0.0.0.0 (0.0.0.0 means Don't care)  
 Subnet Mask : 0.0.0.0  
 Port Number : 25 (0 means Don't care)

---

Protocol : TCP  
 Rule Unmatched : Next

**Step 4:** Select the Protocol as “TCP” and select the Unmatched rule as “Next”.

**Step 5:** Finally, click the **SAVE** to save the entry.

**Step 6:** Go to Step 2 to configure the next two rules: Block E-mail received by the IP address 192.168.1.7 on your local network; Make the PC with IP address 192.168.1.8 unable to visit the website of IP address 202.96.134.12.

**Note:**



After you complete the IP filter rules for the example, the Filter list will show as follows. You can enter the **IP / MAC Filter Set Index** to view the information about the rule.

#	Active	Src Address/Mask	Dest IP/Mask	Src Port	Dest Port	Protocol	Unmatched
1	Yes	192.168.1.7/ 255.255.255.255	0.0.0.0/ 0.0.0.0	0	25	TCP	Next
2	Yes	192.168.1.7/ 255.255.255.255	0.0.0.0/ 0.0.0.0	0	110	TCP	Forward
3	Yes	192.168.1.8/ 255.255.255.255	202.96.134.12/ 255.255.255.255	0	0	TCP	Forward

**Other operations for the entries as shown in Figure 4-39:**

Select the **IP / MAC Filter Set Index** and **IP/MAC Filter Rule Index** to view or modify the entry. Select the **IP / MAC Filter Set Index** and **IP/MAC Filter Rule Index** to locate the specific rule, and then click the **DELETE** button to delete the entry.

**4.5.2.2 MAC Filter**

Select **IP/MAC Filter** as the Filter type, and select **MAC** as the Rule type (shown in Figure 4-40), and then you can configure the filter rules based on MAC address.

The screenshot shows the configuration page for IP/MAC filters. The 'Filter' tab is active, and 'Filter Type Selection' is set to 'IP / MAC Filter'. Under 'IP / MAC Filter Set Editing', the 'IP / MAC Filter Set Index' is 1, the 'Interface' is PVC0, and the 'Direction' is Both. Under 'IP / MAC Filter Rule Editing', the 'IP / MAC Filter Rule Index' is 1, the 'Rule Type' is MAC, and the 'Active' checkbox is checked. The 'MAC Address' field is set to 00:0a:eb:00:07:be, and the 'Rule Unmatched' dropdown is set to Next. At the bottom, a table shows the current filter rules:

#	Active	Src Address/Mask	Dest IP/Mask	Src Port	Dest Port	Protocol	Unmatched
1	Yes	00:0a:eb:00:07:be	-	-	-	-	Next
2	Yes	00:0a:eb:00:07:5f	-	-	-	-	Forward
3	-	-	-	-	-	-	-
4	-	-	-	-	-	-	-
5	-	-	-	-	-	-	-
6	-	-	-	-	-	-	-

At the bottom of the page, there are buttons for 'SAVE', 'DELETE', and 'CANCEL'.

Figure 4-40

- **Rule Type:** Select MAC for the MAC Filter rule.
- **Active:** Select “Yes” to make the rule to take effect.
- **MAC Address:** Enter the MAC address for the rule.
- **Rule Unmatched:** If the current rule can not match, and you select **Forward**, the modem router will skip the rule and transmit directly. If you select **Next**, the modem router will find the next filter rule (show in Filter list) to match.
- **IP/MAC Filter Listing:** This displays the information about the MAC Filter rules.

**To add a MAC Address filtering entry:**

**For example:** If you want to block the PCs with MAC addresses 00-0A-EB-00-07-BE and 00-0A-EB-00-07-5F to access the Internet, you can configure as follows. Presume the rules are both aimed at the interface PVC0, and their indexes are (1, 1) and (1, 2).

**Step 1:** Select the “IP/MAC Filter” as the Filter Type Selection:

Filter Type Selection : IP / MAC Filter

Select the “MAC” as the Rule Type on the Filter screen (show in Figure 4-40).

Rule Type : MAC

Then you can configure the specific rule for the example.

**Step 2:** Select the **IP/MAC Filter Set Index** and **IP/MAC Filter Rule Index** for the rule, then select the Interface “PVC0”, and select the Direction “Outgoing” for the first rule.

IP / MAC Filter Set Index : 1  
 Interface : PVC0  
 Direction : Outgoing

---

IP / MAC Filter Rule Index : 1  
 Rule Type : MAC  
 Active :  Yes  No

**Note:**

If you want to make the rule take effect, please select **Yes** to active the rule.

**Step 3:** Enter the “MAC Address” and select the Unmatched rule as “Next”.

MAC Address : 00:0A:EB:00:07:BE  
 Rule Unmatched : Next

**Step 4:** Finally, click the **SAVE** to save the entry.

**Step 5:** Go to Step 2 to configure the next rule: Block the PC with MAC address 00-0A-EB-00-07-5F to access the Internet.

**Note:**

After you complete the MAC filter rules for the example, the Filter list will show as follows. You can enter the **IP / MAC Filter Set Index** to view the information about the rule.

#	Active	Src Address/Mask	Dest IP/Mask	Src Port	Dest Port	Protocol	Unmatched
1	Yes	00:0a:eb:00:07:be	-	-	-	-	Next
2	Yes	00:0a:eb:00:07:5f	-	-	-	-	Forward

**Other operations for the entries as shown in Figure 4-39:**

Select the **IP / MAC Filter Set Index** and **IP/MAC Filter Rule Index** to view or modify the entry.

Select the **IP / MAC Filter Set Index** and **IP/MAC Filter Rule Index** to locate the specific rule, and then click the **DELETE** button to delete the entry.

**4.5.2.3 Application Filter**

Select **Application Filter** as the Filter type (shown in Figure 4-41), and then you can configure the filter rules based on application.

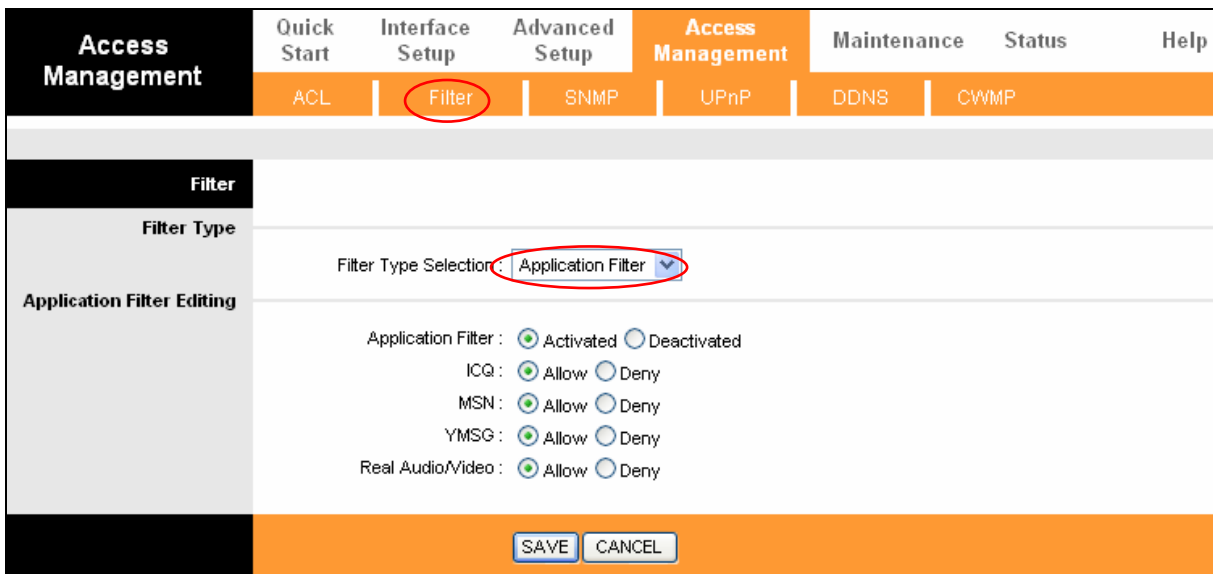

Figure 4-41

- **Filter Type Selection:** Select the Application Filter for the next configuration.
- **Application Filter:** Activate or deactivate the function.
- **ICQ & MSN & YMSG & Real Audio/Video:** Select **Allow** or **Deny** for these applications. If you select Allow, the modem router will accept the application; if you select Deny, the modem router will forbid the application.

#### 4.5.2.4 URL

Select **Application Filter** as the Filter type (shown in Figure 4-42), and then you can configure the filter rules based on URL.

**Filter**

**Filter Type**

Filter Type Selection: URL Filter

**URL Filter Editing**

Active:  Yes  No

URL Index: 3

URL: www.sina.com

**URL Filter Listing**

Index	URL
1	www.baidu.com
2	www.cnw.com.cn
3	www.sina.com
4	
5	
6	
7	
8	
9	
10	
11	
12	
13	
14	
15	
16	

SAVE DELETE CANCEL

Figure 4-42

- **Filter Type Selection:** Select the URL Filter for the next configuration.
- **Active:** Select “Yes” to make the rule to take effect.
- **URL Index:** Select the index for the URL Filter entry.
- **URL:** Enter the URL for this URL Filter.
- **URL Filter Listing:** This displays the information about the URL Filter rules.

**To add a URL filter entry:**

**For example:** If you want to forbid the user to access the website: [www.yahoo.com](http://www.yahoo.com). Presume the rule is aimed at the interface PVC0, and its index is “1”.

**Step 1:** Select the “URL Filter” as the Filter Type Selection (show in Figure 4-42).

**Step 2:** Select the Index for the rule, and then enter the website in the URL field.

**Step 3:** Finally, Select **Yes** to activate the rule, and then click the **SAVE** to save the entry.

**Other operations for the entries as shown in Figure 4-39:**

Select the **URL Index** to view or modify the entry.

Select the **URL Index** to locate the specific rule, and then click the **DELETE** button to delete the entry.

### 4.5.3 SNMP

Choose “**Access Management**→**SNMP**”, you can see the SNMP screen. The Simple Network Management Protocol (SNMP) is used for exchanging information between network devices.

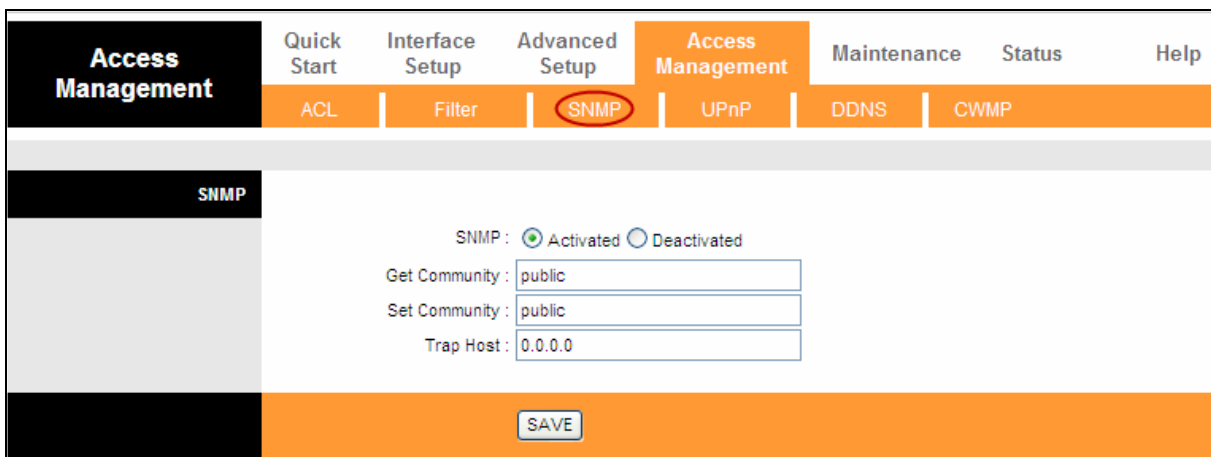

Figure 4-43

- **Get Community:** Set the password for the incoming Get and Get next requests from the management station.
- **Set Community:** Set the password for incoming Set requests from the management station.

### 4.5.4 UPnP

Choose “**Access Management**→**UPnP**”, you can configure the UPnP in the screen (shown in Figure 4-44).

UPnP (Universal Plug and Play) is a distributed, open networking standard that uses TCP/IP for simple peer-to-peer network connectivity between devices. An UPnP device can dynamically join a network, obtain an IP address, convey its capabilities and learn about other devices on the network. In turn, a device can leave a network smoothly and automatically when it is no longer in use. UPnP broadcasts are only allowed on the LAN.

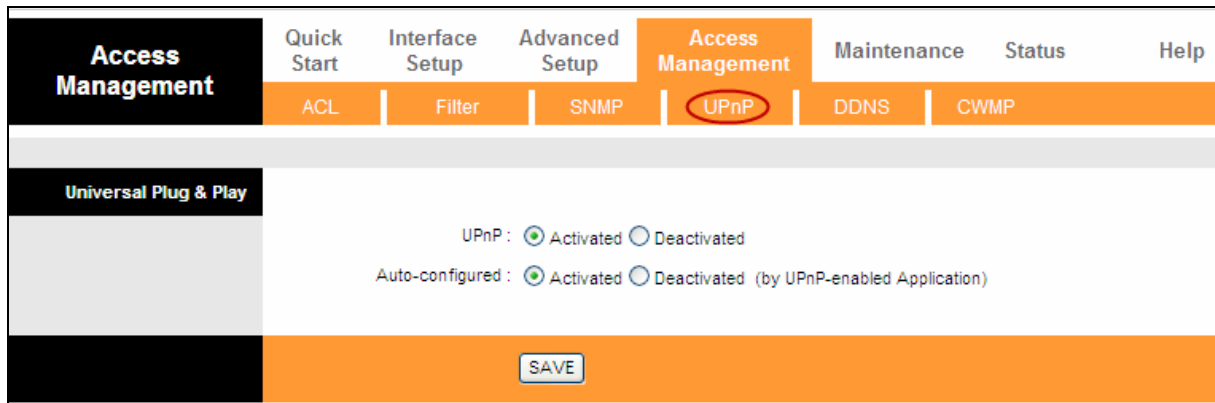

Figure 4-44

- **UPnP:** Activate or Deactivate the UPnP function. Only when the function is activated, can the UPnP take effect.
- **Auto-Configure:** If you activate the function, then the UPnP network devices can automatically configure network addressing, announce their presence in the network to other UPnP devices and enable exchange of simple product and service descriptions.

#### 4.5.5 DDNS

Choose “**Access Management**→**DDNS**”, you can configure the DDNS function in the screen (shown in Figure 4-45).

The modem router offers a Dynamic Domain Name System (**DDNS**) feature. The feature lets you use a static host name with a dynamic IP address. User should type the host name, user name and password assigned to your ADSL modem router by your Dynamic DNS provider.

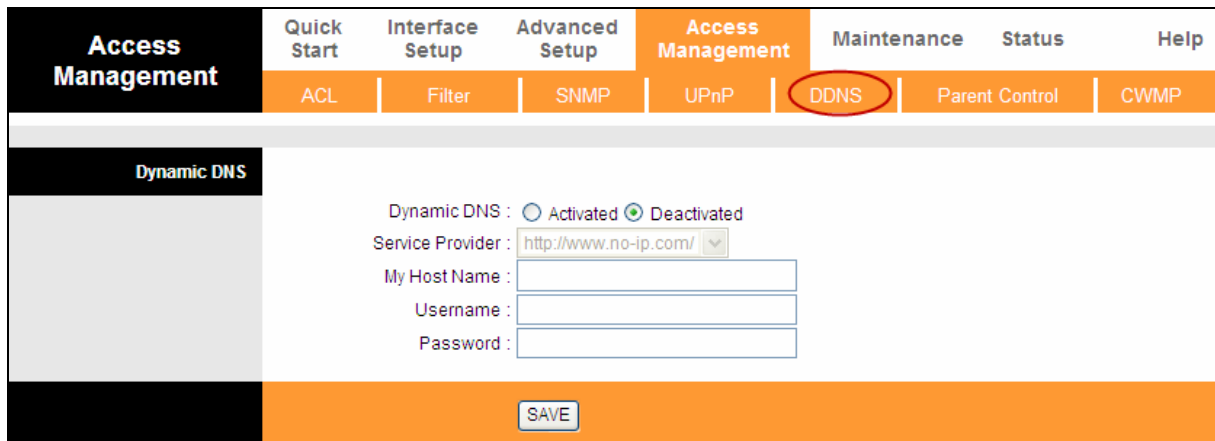

Figure 4-45

- **Dynamic DNS:** Activate the DDNS function or not.
- **Service Provider:** This field displays the service provider of DDNS.
- **My Host Name:** Enter your host name here.
- **Username & Password:** Type the “User Name” and “Password” for your DDNS account.

### 4.5.6 CWMP

Choose “**Access Management**→**CWMP**”, you can configure the CWMP function in the screen (shown in Figure 4-46).

The modem router offers CWMP feature. The function supports TR-069 protocol which collects information, diagnoses the devices and configures the devices automatically via ACS (Auto-Configuration Server).

Figure 4-46

- **CWMP:** Select activate the CWMP function.
- **URL:** Enter the website of ACS which is provided by your ISP.
- **User Name/Password:** Enter the User Name and password to login the ACS server.
- **Path:** Enter the path that connects to the ACS server.
- **Port:** Enter the port that connects to the ACS server.
- **User Name/Password:** Enter the User Name and Password that provided the ACS server to login the modem router.
- **Periodic Inform:** Activate or deactivate the function. If Activated, the information will be informed to ACS server periodically.
- **Interval:** Enter the interval time here.

## 4.6 Maintenance

Choose “**Maintenance**”, you can see the next submenus:



Figure 4-47

Click any of them, and you will be able to configure the corresponding function.

### 4.6.1 Administration

Choose “**Maintenance**→**Administration**”, you can set new password for admin in the screen (shown in Figure 4-48).

 A screenshot of the 'Administrator' configuration page. The top navigation bar is identical to Figure 4-47, with 'Administration' circled in red. Below the navigation, the page title is 'Administrator'. The form contains:
 

- Username: admin
- New Password: [text input field]
- Confirm Password: [text input field]

 At the bottom, there are 'SAVE' and 'CANCEL' buttons.

Figure 4-48

#### Note:

- 1) There is only one account that can access Web-Management interface. The default account is "admin", and the password is "admin". Admin has read/write access privilege.
- 2) When you change the password, you should enter the new password twice, and then click **SAVE** to make the new password take effect.

### 4.6.2 Time Zone

Choose “**Maintenance**→**Time Zone**”, you can configure the system time in the screen (shown in Figure 4-49).

The system time is the time used by the device for scheduling services. There are three methods to configure the time. You can manually set the time or connect to a NTP (Network Time Protocol) server. If a NTP server is set, you will only need to set the time zone. If you manually set the time, you may also set Daylight Saving dates and the system time will automatically adjust on those



dates.

**1) NTP Server automatically**

Select **NTP Server automatically** as the Synchronize time, you only need to set the time zone.

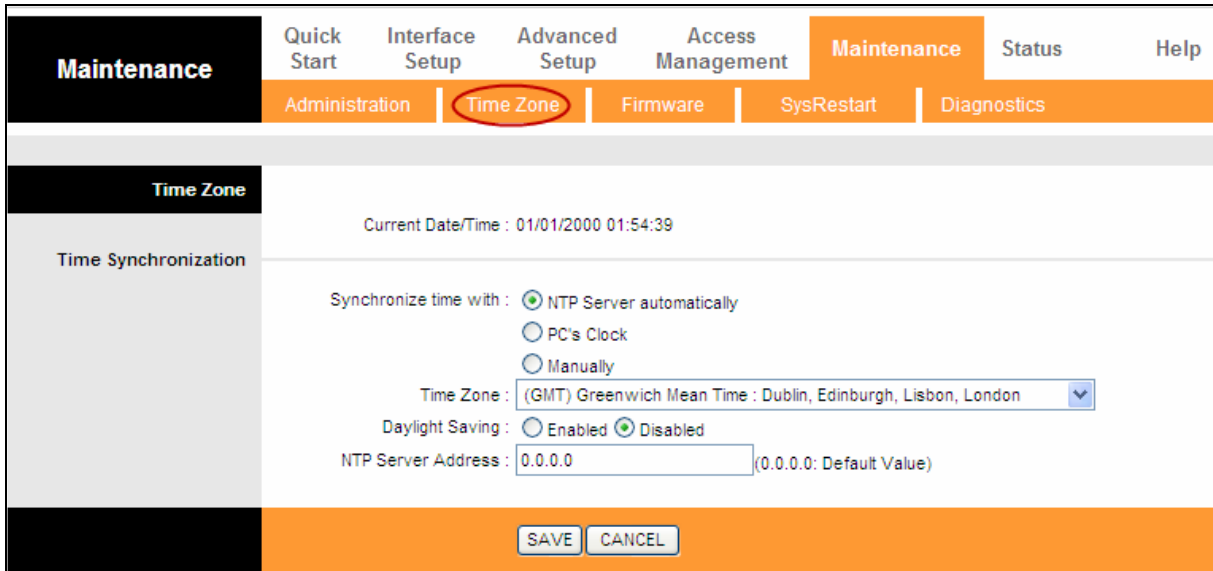

Figure 4-49

**Note:**

The ADSL modem router built-in some NTP Servers, when the modem router connects to the Internet, the modem router will get the system time automatically from the NTP Server. You can also configure the NTP Server address manually, and then the modem router will get the time from the specific Server firstly.

**2) PC's Clock**

Select **PC's Clock** as the Synchronize time, you don't need to set any items.

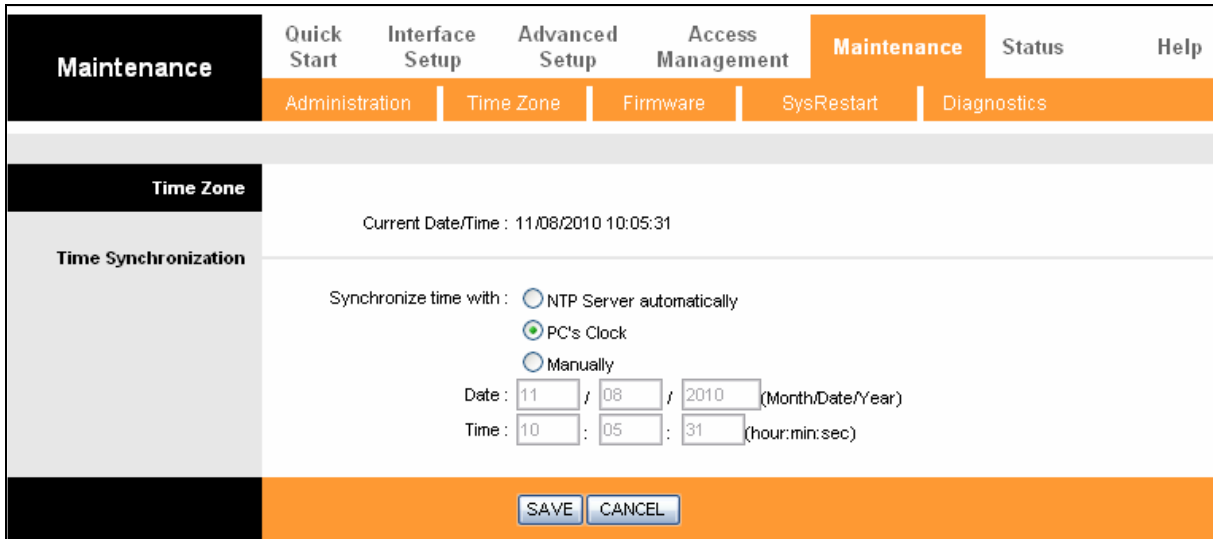

Figure 4-50

### 3) Manually

Select **Manually** as the Synchronize time, you need to set the date and time corresponding to the current time.

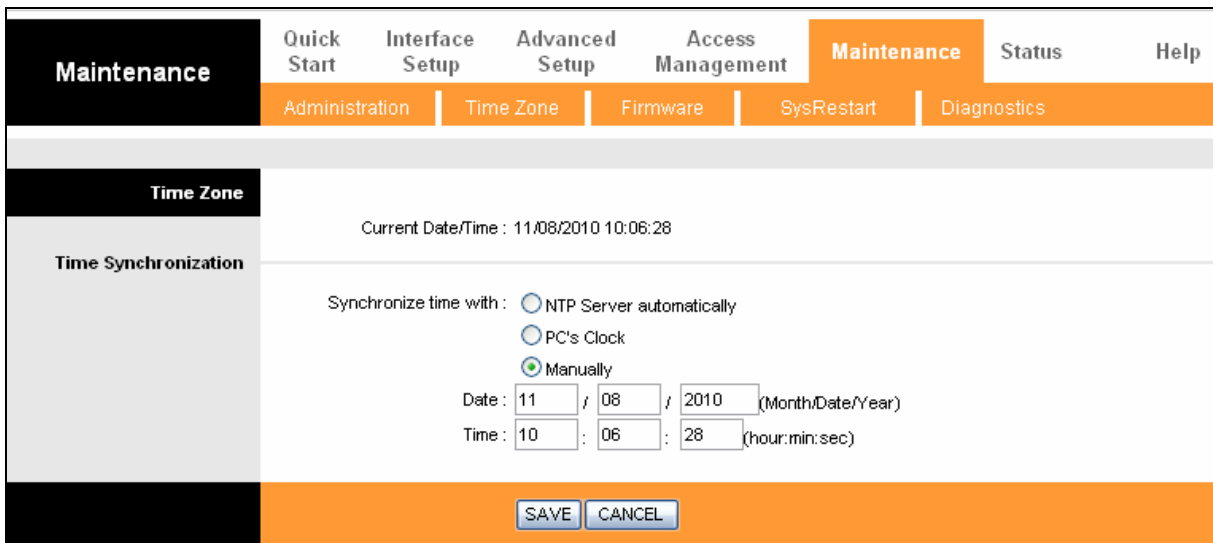

Figure 4-51

### 4.6.3 Firmware

Choose “**Maintenance**→**Firmware**”, you can upgrade the firmware of the modem router in the screen (shown in Figure 4-52). Make sure the firmware or romfile you want to use is on the local hard drive of the computer. Click **Browse** to find the local hard drive and locate the firmware or romfile to be used for upgrade.

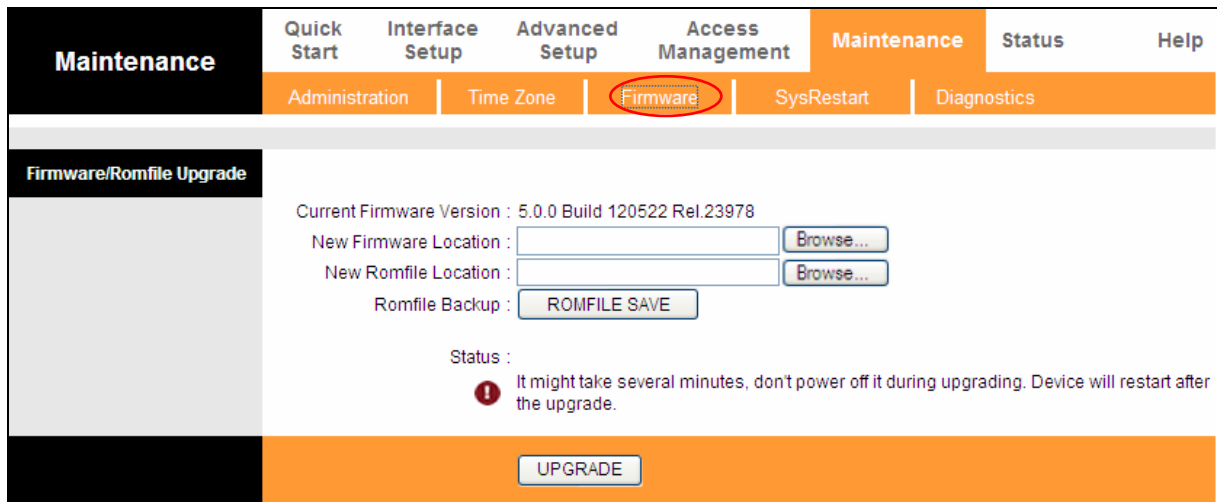

Figure 4-52

**To upgrade the modem router's firmware, follow these instructions below:**

**Step 1:** Type the path and file name of the update file into the “New Firmware Location” field. Or click the **Browse** button to locate the update file.

**Step 2:** Click the **UPGRADE** button.

**Note:**

- 1) When you upgrade the modem router's firmware, you may lose its current configurations, so please back up the modem router's current settings before you upgrade its firmware.
- 2) Do not turn off the modem router or press the Reset button while the firmware is being upgraded.
- 3) The modem router will reboot after the upgrading has been finished.

**To back up the modem router's current settings:**

**Step 1:** Click the **ROMFILE SAVE** button (shown in Figure 4-52), click **Save** button in the next screen (shown in Figure 4-53) to proceed.

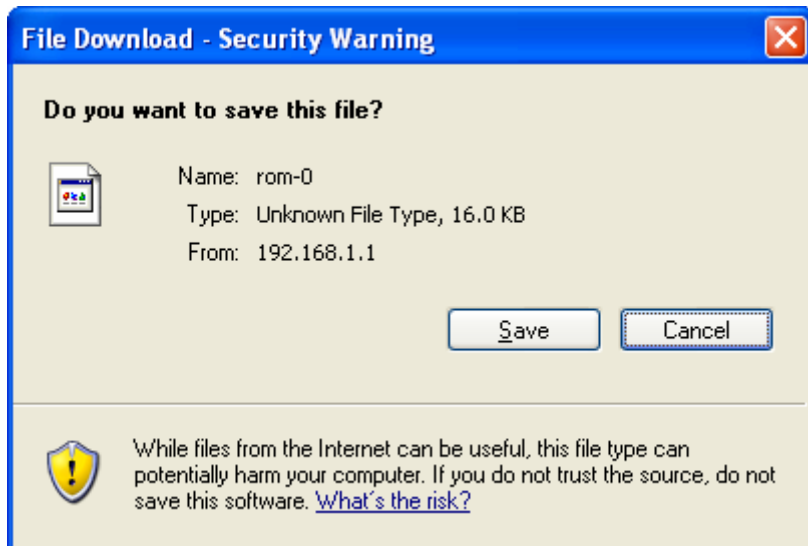

Figure 4-53

**Step 2:** Save the file as the appointed file (shown in Figure 4-54).

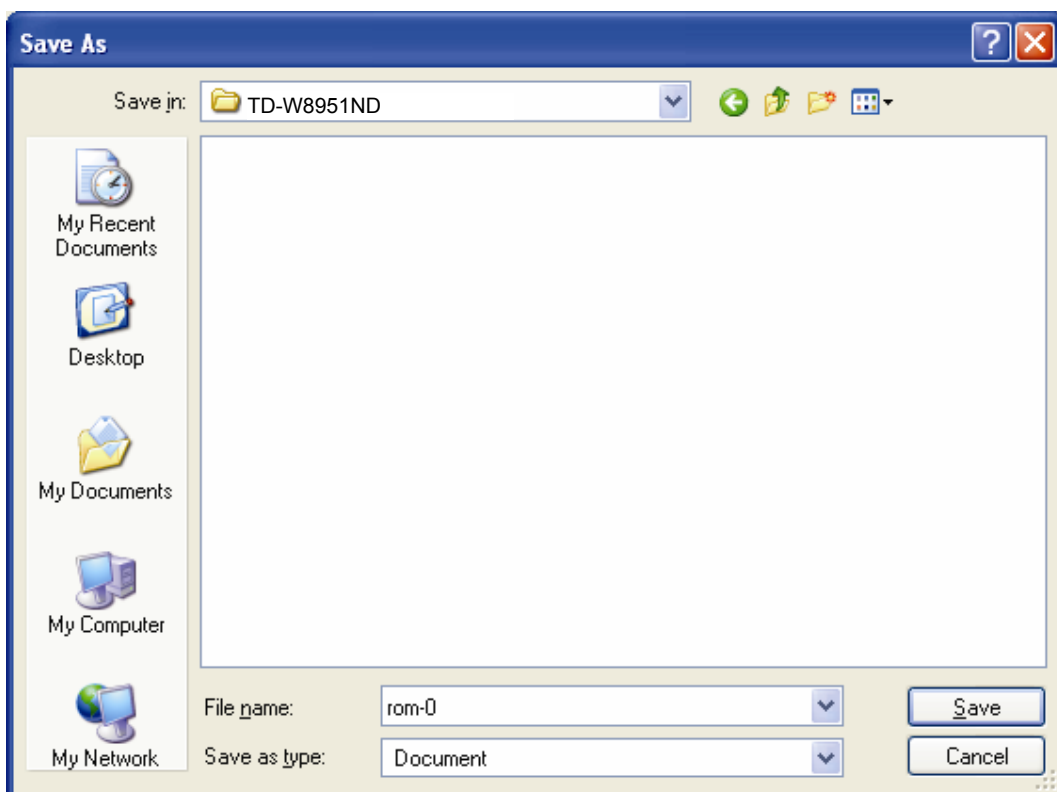

Figure 4-54

**To restore the modem router's settings:**

**Step 1:** Click the **Browse** button to locate the update file for the device, or enter the exact path in "New Romfile Location" field.

**Step 2:** Click the **UPGRADE** button to complete.

#### 4.6.4 SysRestart

Choose “**Maintenance**→**SysRestart**”, you can select to restart the device with current settings or restore to factory default settings in the screen (shown in Figure 4-55).

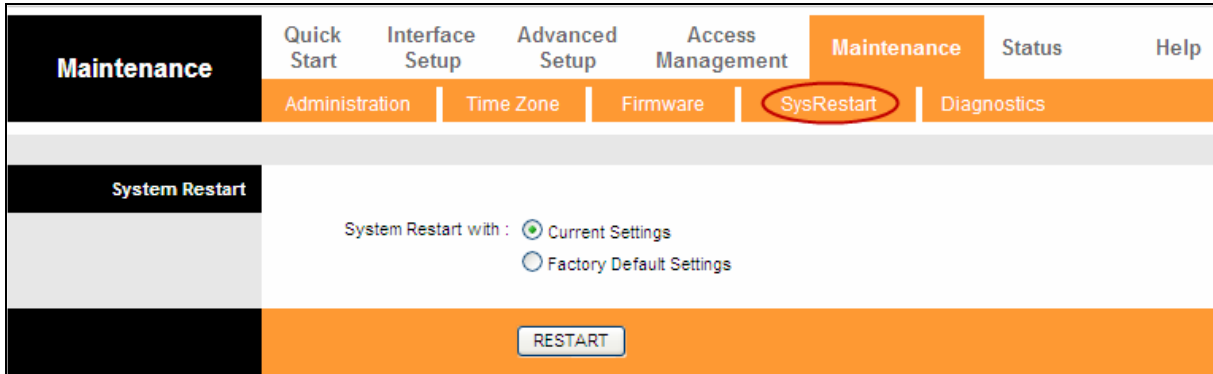

Figure 4-55

#### 4.6.5 Diagnostics

Choose “**Maintenance**→**Diagnostics**”, you can view the test results for the connectivity of the physical layer and protocol layer for both LAN and WAN sides in the screen (shown in Figure 4-56).

The screenshot displays the router's web interface. At the top, a navigation bar includes 'Quick Start', 'Interface Setup', 'Advanced Setup', 'Access Management', 'Maintenance', 'Status', and 'Help'. The 'Maintenance' section is active, with sub-menus for 'Administration', 'Time Zone', 'Firmware', 'SysRestart', and 'Diagnostics' (circled in red). The 'Diagnostic Test' section shows a 'Virtual Circuit' dropdown set to 'PVC0'. Below this, a list of diagnostic tests is shown with their results: '>> Testing Ethernet LAN connection ...' (PASS), '>> Testing ADSL Synchronization .' (FAIL), '>> Testing ATM OAM segment ping ...' (SKIPPED), '>> Testing ATM OAM end to end ping ...' (SKIPPED), '>> Testing ATM OAM F4 segment ping ...' (SKIPPED), '>> Testing ATM OAM F4 end to end ping ...' (SKIPPED), '>> Ping Primary Domain Name Server .' (SKIPPED), and '>> Ping www.yahoo.com ...' (SKIPPED). The 'Ping Tool' section below has an input field for 'IP Address/Domain Name:' and a 'Ping' button. A text area below the input field contains '- Info -'.

Figure 4-56

## 4.7 Help

Choose “**Help**”, you can view the help information for configuration of any function.







Help	Quick Start	Interface Setup	Advanced Setup	Access Management	Maintenance	Status	Help
<b>Quick Start</b>	<ul style="list-style-type: none"> <li>▶ Quick Start</li> </ul>						
<b>Interface Setup</b>	<ul style="list-style-type: none"> <li>▶ Internet Settings</li> <li>▶ LAN Settings</li> <li>▶ Wireless LAN Settings</li> </ul>						
<b>Advanced Setup</b>	<ul style="list-style-type: none"> <li>▶ Firewall</li> <li>▶ Routing</li> <li>▶ NAT</li> <li>▶ QoS</li> <li>▶ VLAN</li> <li>▶ ADSL</li> </ul>						
<b>Access Management</b>	<ul style="list-style-type: none"> <li>▶ ACL</li> <li>▶ IP Filter</li> <li>▶ SNMP</li> <li>▶ UPnP</li> <li>▶ DDNS</li> <li>▶ CWMP</li> </ul>						
<b>Maintenance</b>	<ul style="list-style-type: none"> <li>▶ Administration</li> <li>▶ Time Zone</li> <li>▶ Firmware</li> <li>▶ SysRestart</li> <li>▶ Diagnostics</li> </ul>						
<b>Status</b>	<ul style="list-style-type: none"> <li>▶ Device Info</li> <li>▶ System Log</li> <li>▶ Statistics</li> </ul>						

Figure 4-57

 **Note:**

Click the tab, and you will be able to get the corresponding information.

## Appendix A: Specifications

<b>General</b>	
Standards and Protocols	ANSI T1.413, ITU G.992.1, ITU G.992.2, ITU G.992.3, ITU G.992.5, IEEE 802.11b, IEEE 802.11g, IEEE 802.11n, IEEE 802.3, IEEE 802.3u, TCP/IP, PPPoA, PPPoE, SNTP, HTTP, DHCP, ICMP, NAT
Safety & Emission	FCC, CE
Ports	Four 10/100M Auto-Negotiation RJ45 ports (Auto MDI/MDIX) One RJ11 port
LEDs	 (Power),  (ADSL),  (Internet),  (WLAN),  (WPS),  (LAN1-4)
Network Medium	10Base-T: UTP category 3, 4, 5 cable 100Base-TX: UTP category-5 Max line length: 6.5Km
Data Rates	Downstream: Up to 24Mbps Upstream: Up to 3.5Mbps (With Annex M enabled)
System Requirement	Internet Explorer 5.0 or later, Netscape Navigator 6.0 or later Win 9x/ ME/ 2000/ XP/ Vista/ 7
<b>Physical and Environment</b>	
Working Temperature	0°C ~ 40°C
Working Humidity	10% ~ 90% RH (non-condensing)
Storage Temperature	-40°C ~ 70°C
Storage Humidity	5% ~ 90% RH (non-condensing)



## Appendix B: Troubleshooting

### T1. How do I restore my modem router's configuration to its factory default settings?

With the modem router powered on, press and hold the **RESET** button on the rear panel for 8 to 10 seconds before releasing it.

 **Note:**

Once the modem router is reset, the current configuration settings will be lost and you will need to re-configure the modem router.

### T2. What can I do if I don't know or forget my password?

- 1) Restore the modem router's configuration to its factory default settings. If you don't know how to do that, please refer to **T1**.
- 2) Use the default user name and password: **admin, admin**.
- 3) Try to configure your modem router once again by following the instructions in [3.2 Login](#).

### T3. What can I do if I cannot access the web-based configuration page?

- 1) Configure your computer's IP Address.

#### For Windows XP OS

Go to **Start > Control Panel**, you will then see the following page.

Click **Network and Internet Connections**

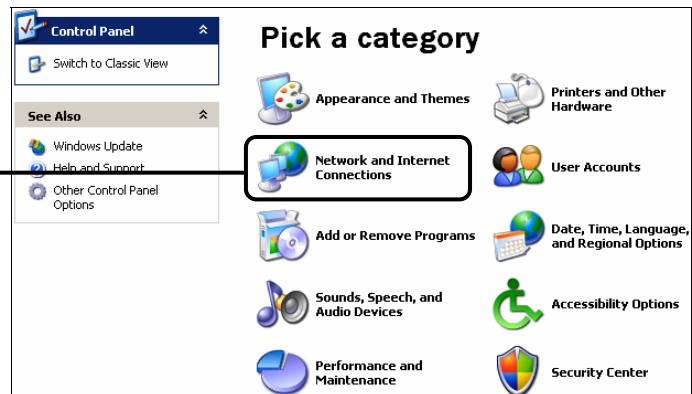

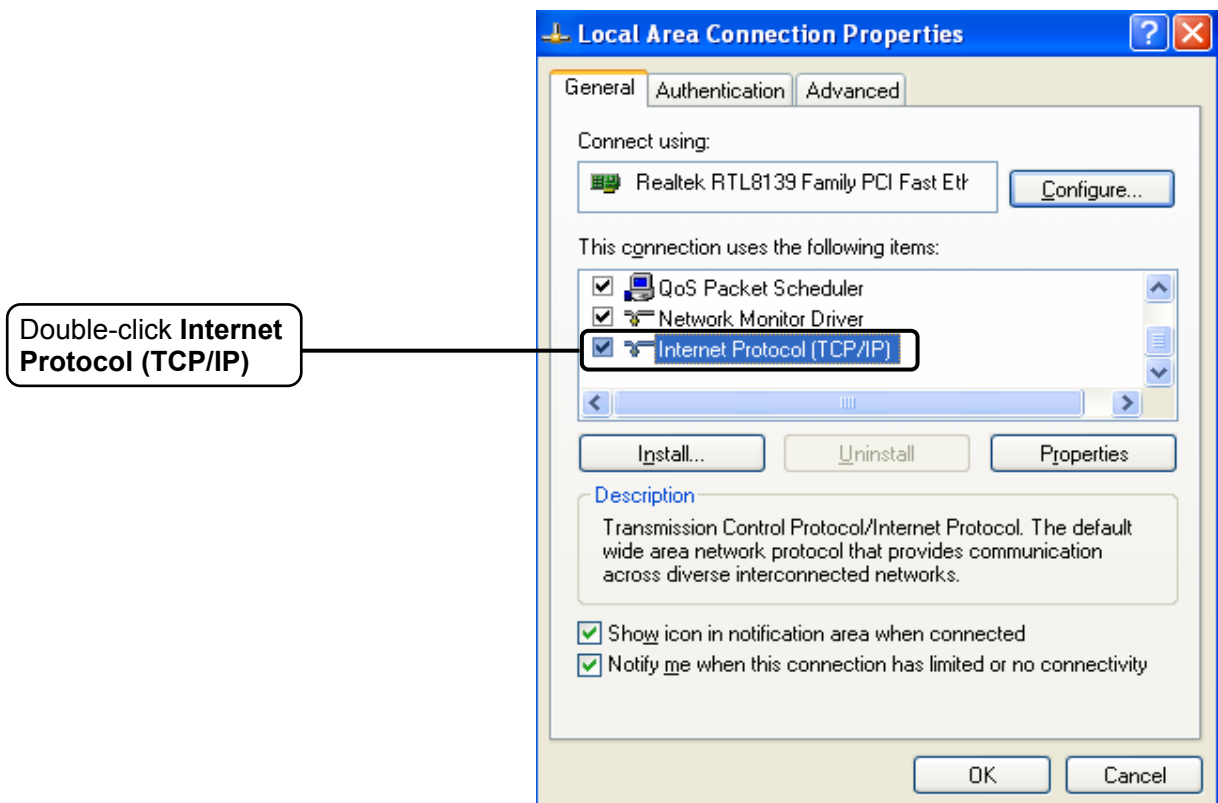
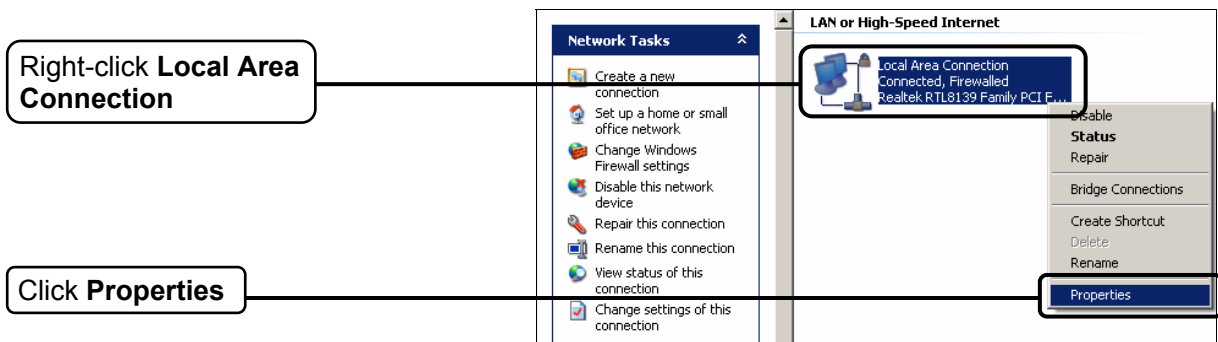
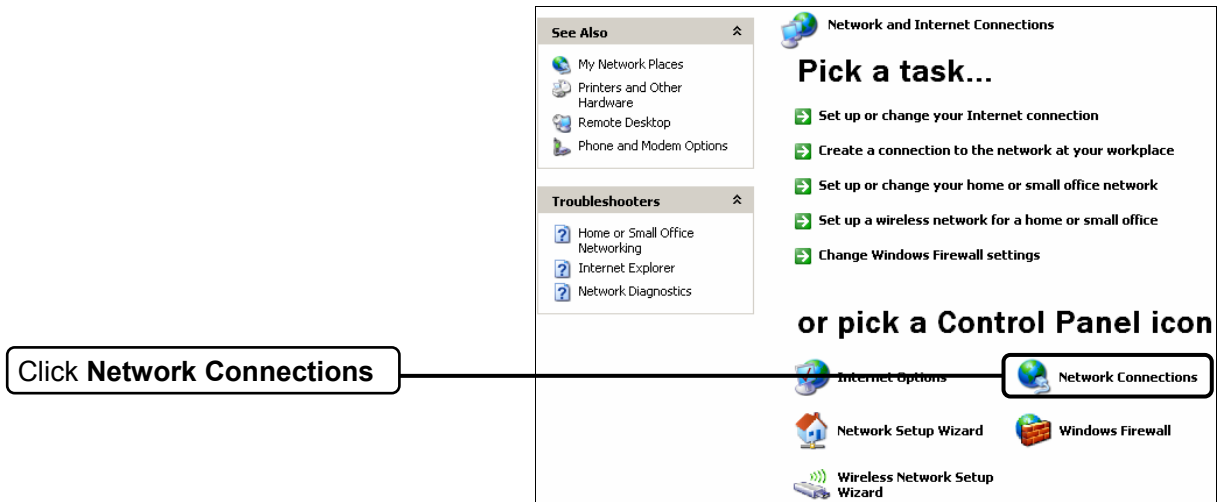

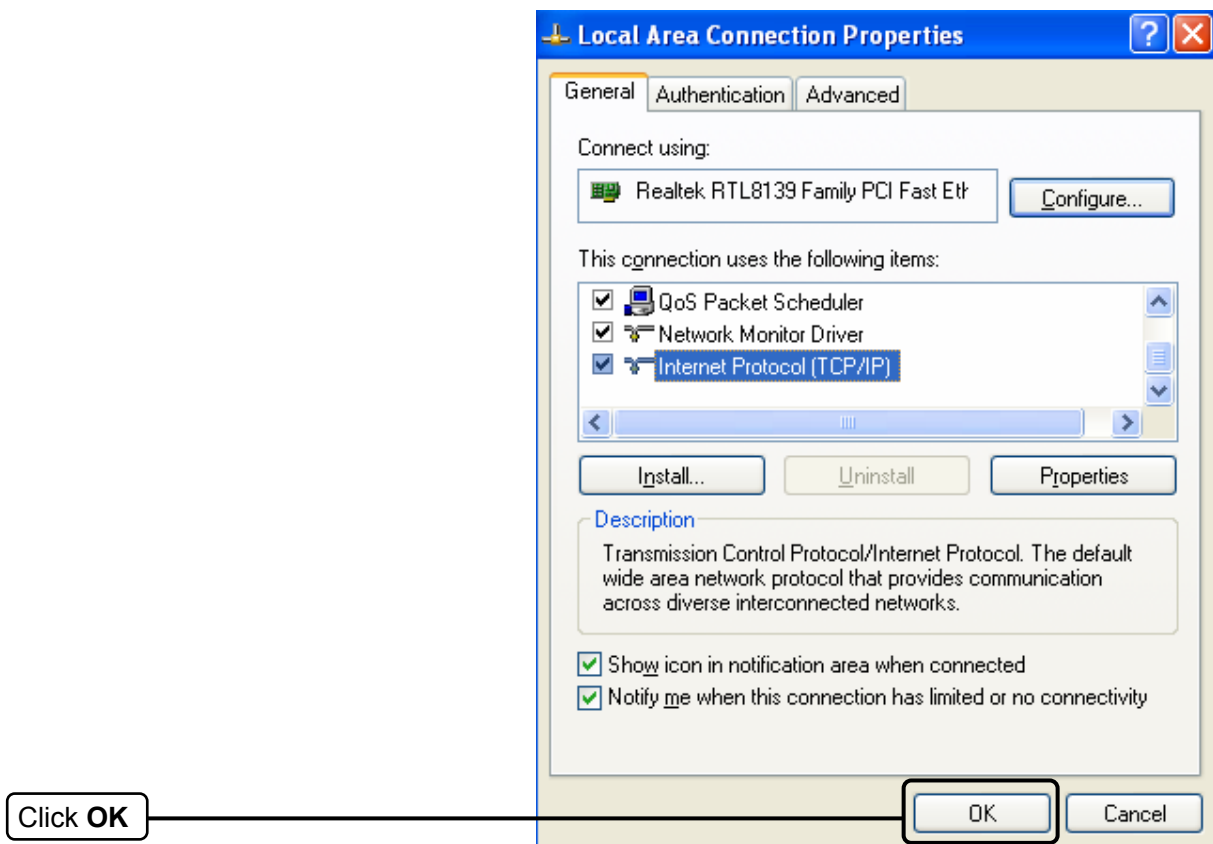
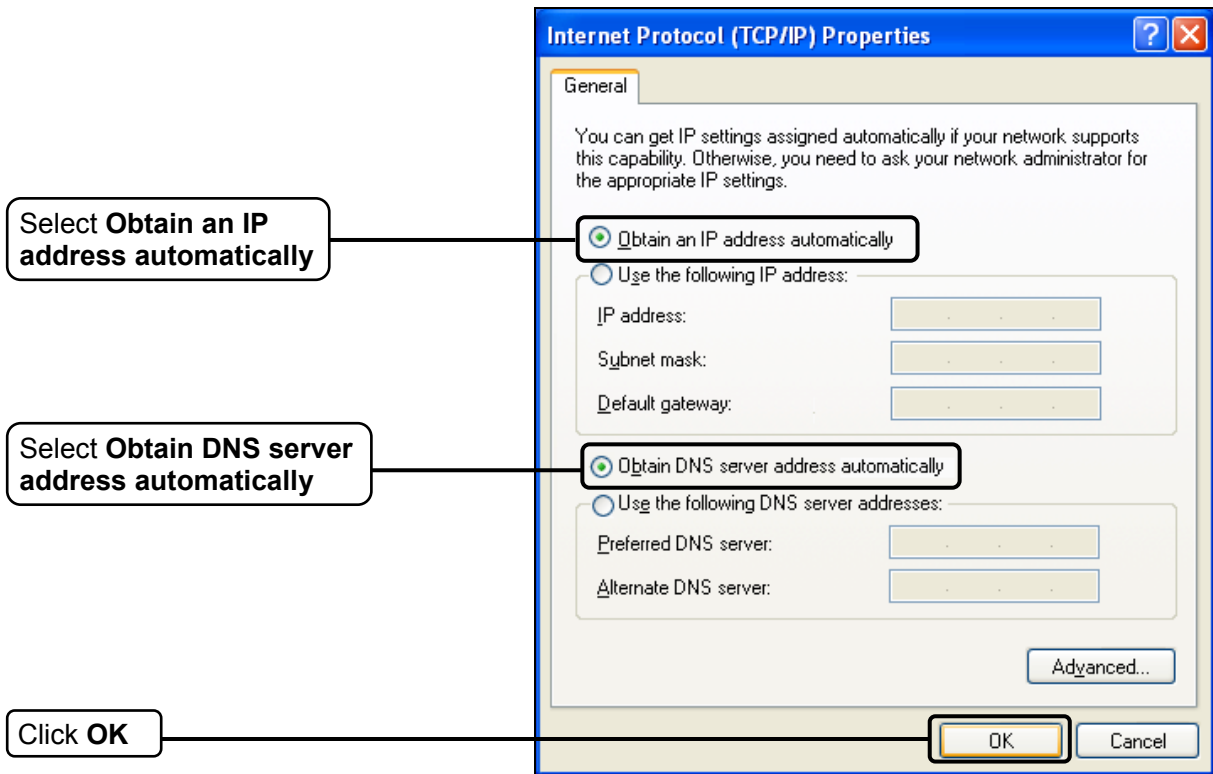

**For Windows Vista OS**

Go to **Start > Settings > Control Panel**, and then you will see the following page.

Click **View network status and tasks**

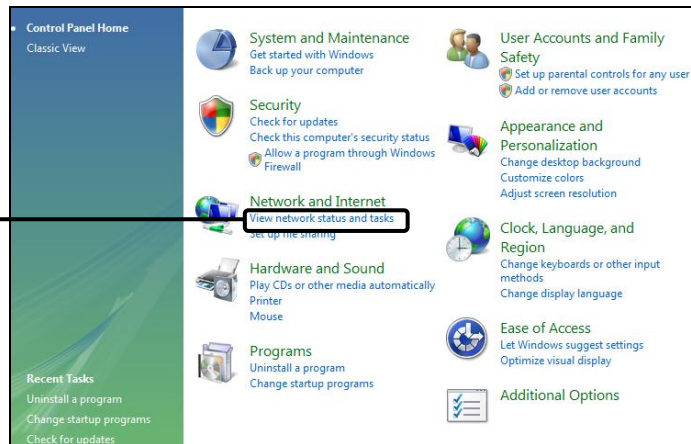

Click **View status**

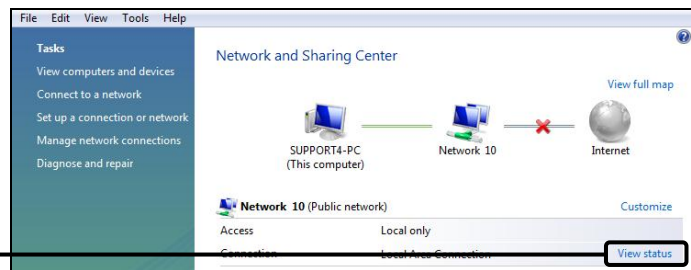

Click **Properties**

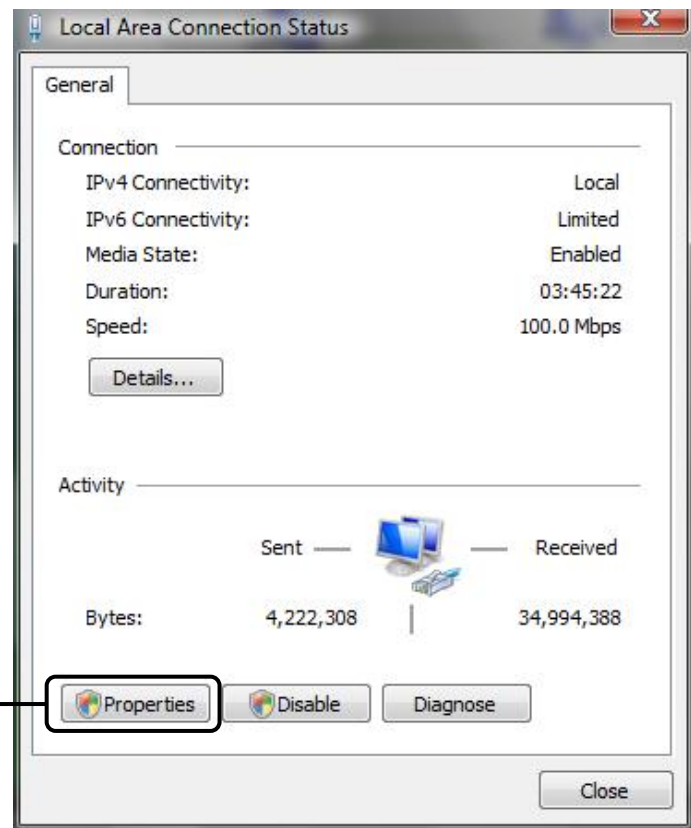

Double-click **Internet Protocol Version 4 (TCP/IPv4)**

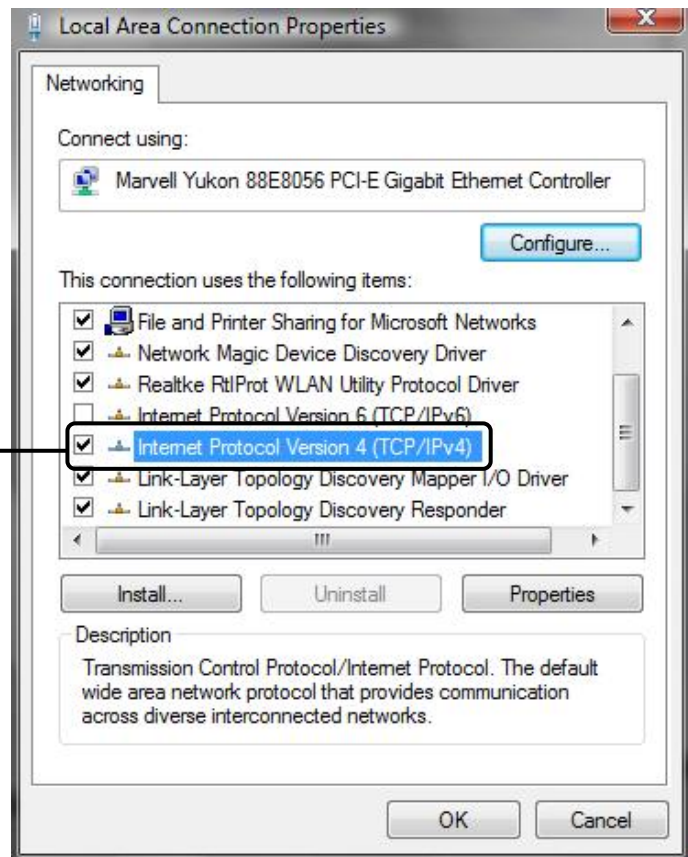

Select **Obtain an IP address automatically**

Select **Obtain DNS server address automatically**

Click **OK**

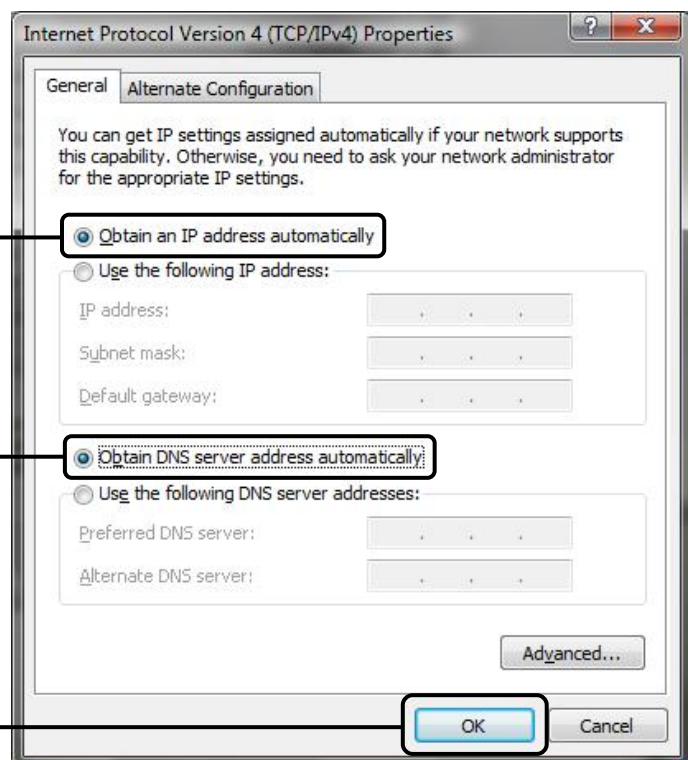

**For Windows 7 OS**

Go to **Start > Settings > Control Panel**, and then you will see the following page.

Click **View network status and tasks**

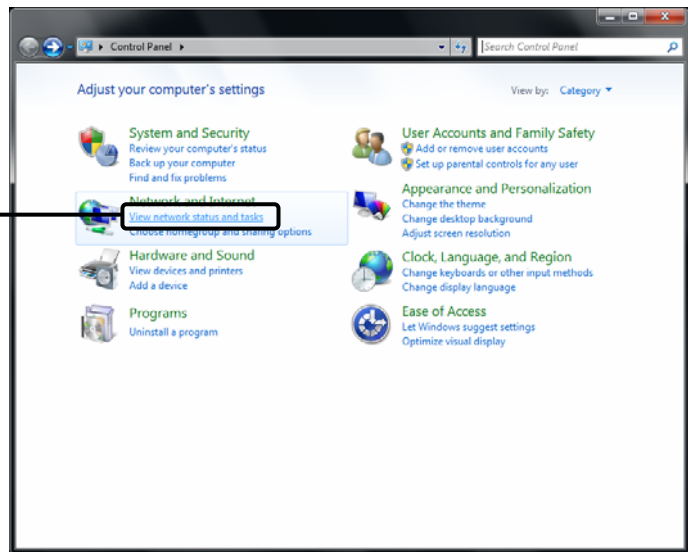

Click **Change adapter settings**

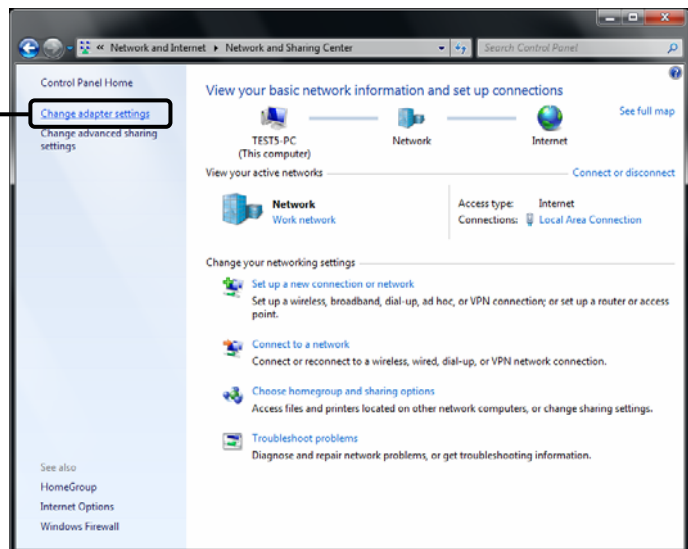

Right-click **Local Area Connection**

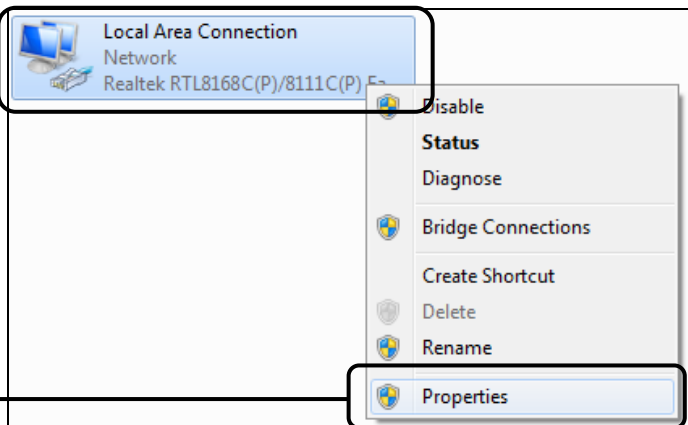

Click **Properties**

Double-click **Internet Protocol Version 4 (TCP/IPv4)**

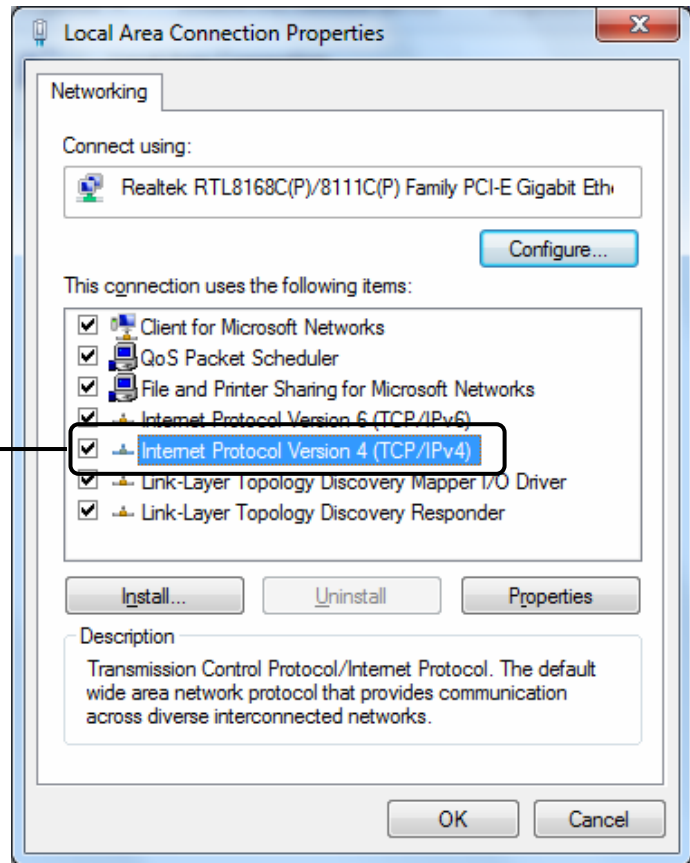

Select **Obtain an IP address automatically**

Select **Obtain DNS server address automatically**

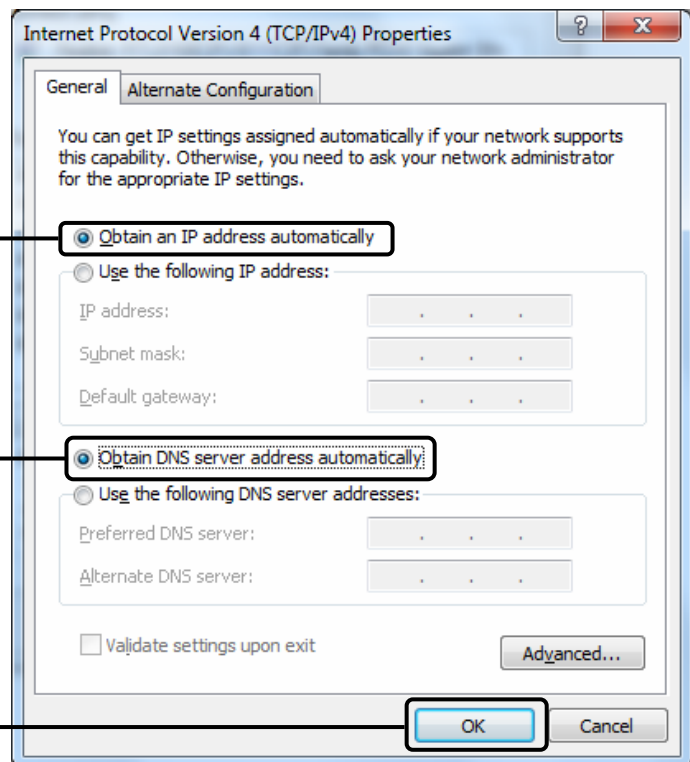

Click **OK**

2) Configure your IE browser

Open your IE browser, click **Tools** tab and you will see the following screen.

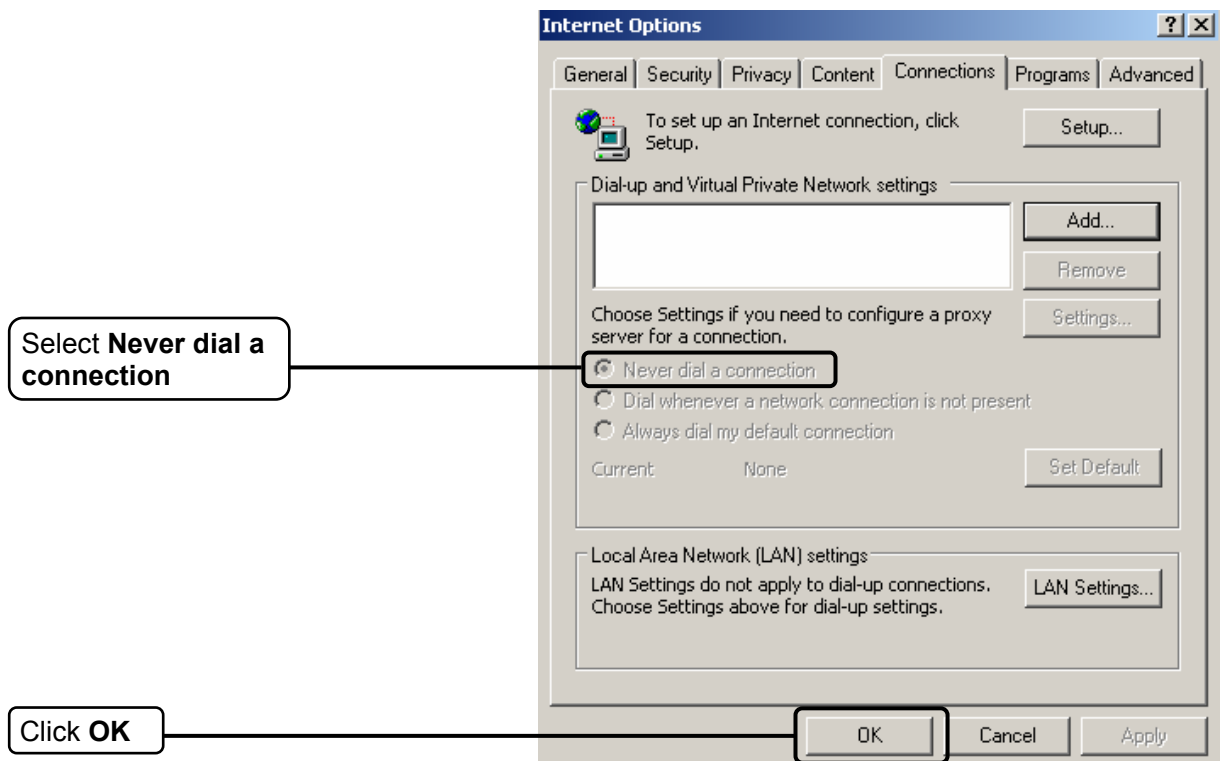
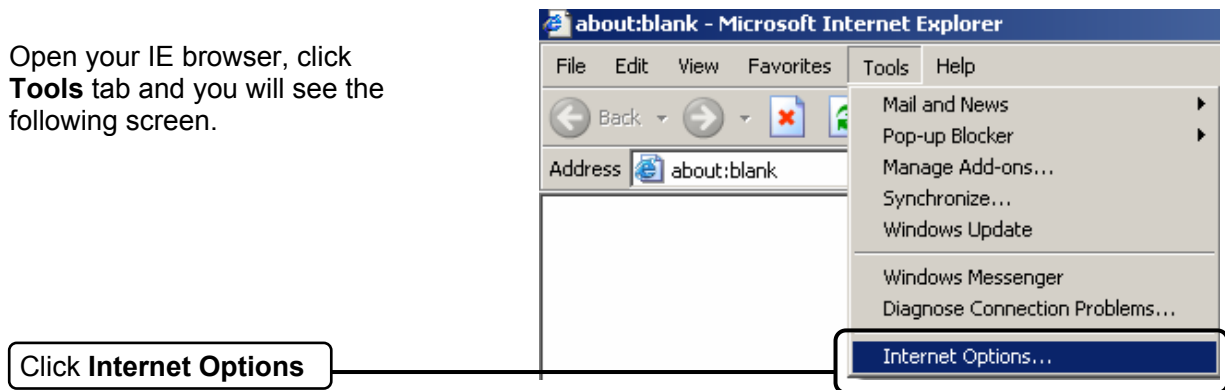

Now, try to log on to the Web-based configuration page again after the above settings have been configured. If you still cannot access the configuration page, please restore your modem router's factory default settings and reconfigure your modem router following the instructions in [3.2 Login](#). Please feel free to contact our Technical Support if the problem persists.

**T4. What can I do if I cannot access the Internet?**

- 1) Check to see if all the connectors are connected well, including the telephone line, Ethernet cables and power adapter.
- 2) Check to see if you can log on to the web management page of the Modem Router. If you can, try the following steps. If you cannot, please set your computer referring to **T3** then try to see if you can access the Internet. If the problem persists, please go to the next step.
- 3) Consult your ISP and make sure all the VPI/VCI, Connection Type, account username and



password are correct. If there are any mistakes, please correct the settings and try again.

- 4) If you still cannot access the Internet, please restore your modem router to its factory default settings and reconfigure your modem router by following the instructions of in [3.2 Login](#).
- 5) Please feel free to contact our Technical Support if the problem still exists.

 Note:

For more details about Troubleshooting and Technical Support contact information, please log on to our Technical Support Website: <http://www.tp-link.com/en/support>

## Appendix C: Technical Support

### Technical Support

- For more troubleshooting help, go to:  
<http://www.tp-link.com/en/support/faq>
- To download the latest Firmware, Driver, Utility and User Guide, go to:  
<http://www.tp-link.com/en/support/download>
- For all other technical support, please contact us by using the following details:

#### Global

Tel: +86 755 2650 4400  
 Fee: Depending on rate of different carriers, IDD.  
 E-mail: support@tp-link.com  
 Service time: 24hrs, 7 days a week

#### USA/Canada

Toll Free: +1 866 225 8139  
 E-mail: support.usa@tp-link.com(USA)  
 support.ca@tp-link.com(Canada)  
 Service time: 24hrs, 7 days a week

#### Turkey

Tel: 0850 7244 488 (Turkish Service)  
 Fee: Depending on rate of different carriers.  
 E-mail: support.tr@tp-link.com  
 Service time: 09:00 to 21:00, 7 days a week

#### Ukraine

Tel: 0800 505 508  
 Fee: Free for Landline; Mobile: Depending on rate of different carriers  
 E-mail: support.ua@tp-link.com  
 Service time: Monday to Friday, 10:00 to 22:00

#### Brazil

Toll Free: 0800 608 9799 (Portuguese Service)  
 E-mail: suporte.br@tp-link.com  
 Service time: Monday to Friday, 09:00 to 20:00;  
 Saturday, 09:00 to 15:00

#### Indonesia

Tel: (+62) 021 6386 1936  
 Fee: Depending on rate of different carriers.  
 E-mail: support.id@tp-link.com  
 Service time: Sunday to Friday, 09:00 to 12:00, 13:00 to 18:00 \*Except public holidays

#### Australia/New Zealand

Tel: NZ 0800 87 5465 (Toll Free)  
 AU 1300 87 5465 (Depending on 1300 policy.)  
 E-mail: support.au@tp-link.com (Australia)  
 support.nz@tp-link.com (New Zealand)  
 Service time: 24hrs, 7 days a week

#### Germany/Austria

Tel: +49 1805 875 465 (German Service)  
 +49 1805 TPLINK  
 +43 820 820 360  
 Fee: Landline from Germany: 0.14EUR/min.  
 Landline from Austria: 0.20EUR/min.  
 E-mail: support.de@tp-link.com  
 Service time: Monday to Friday, 09:00 to 12:30 and 13:30 to 18:00. GMT+1 or GMT+2 (DST in Germany)  
 \*Except bank holidays in Hesse

#### Singapore

Tel: +65 6284 0493  
 Fee: Depending on rate of different carriers.  
 E-mail: support.sg@tp-link.com  
 Service time: 24hrs, 7 days a week

#### UK

Tel: +44 (0) 845 147 0017  
 Fee: Landline: 1p-10.5p/min, depending on the time of day. Mobile: 15p-40p/min, depending on your mobile network.  
 E-mail: support.uk@tp-link.com  
 Service time: 24hrs, 7 days a week

#### Italy

Tel: +39 023 051 9020  
 Fee: Depending on rate of different carriers.  
 E-mail: support.it@tp-link.com  
 Service time: Monday to Friday, 09:00 to 13:00; 14:00 to 18:00

#### Malaysia

Toll Free: 1300 88 875 465  
 Email: support.my@tp-link.com  
 Service time: 24hrs, 7 days a week

#### Poland

Tel: +48 (0) 801 080 618  
 +48 223 606 363 (if calls from mobile phone)  
 Fee: Depending on rate of different carriers.  
 E-mail: support.pl@tp-link.com  
 Service time: Monday to Friday, 09:00 to 17:00. GMT+1 or GMT+2 (DST)

#### France

Tel: 0820 800 860 (French service)  
 Fee: 0.118 EUR/min from France  
 Email: support.fr@tp-link.com  
 Service time: Monday to Friday, 09:00 to 18:00 \*Except French Bank holidays

#### Switzerland

Tel: +41 (0) 848 800 998 (German Service)  
 Fee: 4-8 Rp/min, depending on rate of different time.  
 E-mail: support.ch@tp-link.com  
 Service time: Monday to Friday, 09:00 to 12:30 and 13:30 to 18:00. GMT+1 or GMT+2 (DST)

#### Russian Federation

Tel: 8 (499) 754 5560 (Moscow NO.)  
 8 (800) 250 5560 (Toll-free within RF)  
 E-mail: support.ru@tp-link.com  
 Service time: From 10:00 to 18:00 (Moscow time) \*Except weekends and holidays in RF