

MITEL

# 5320/5330/5340 IP Phones

SIP User and Administrator Guide  
Release 8.0



## NOTICE

The information contained in this document is believed to be accurate in all respects but is not warranted by Mitel Networks™ Corporation (MITEL®). The information is subject to change without notice and should not be construed in any way as a commitment by Mitel or any of its affiliates or subsidiaries. Mitel and its affiliates and subsidiaries assume no responsibility for any errors or omissions in this document. Revisions of this document or new editions of it may be issued to incorporate such changes.

No part of this document can be reproduced or transmitted in any form or by any means - electronic or mechanical - for any purpose without written permission from Mitel Networks Corporation.

## TRADEMARKS

Mitel is a trademark of Mitel Networks Corporation.

Windows and Microsoft are trademarks of Microsoft Corporation.

Other product names mentioned in this document may be trademarks of their respective companies and are hereby acknowledged.

Mitel 5320/5330/5340 IP Phones - SIP User and Administrator Guide  
Release 8.0  
October 2009

®,™ Trademark of Mitel Networks Corporation  
© Copyright 2009, Mitel Networks Corporation  
All rights reserved

---

<b>GETTING STARTED .....</b>	<b>1</b>
SIP User Accounts and Passwords .....	1
SIP Administrative Mode .....	1
About your SIP Phone .....	1
<b>TIPS FOR YOUR COMFORT AND SAFETY .....</b>	<b>5</b>
Don't cradle the handset!.....	5
Protect your hearing .....	5
Adjust the viewing angle .....	5
<b>USING YOUR DEFAULT PHONE WINDOW AND KEYS .....</b>	<b>6</b>
Call Encryption Indicator.....	7
Accessories for Your Phone .....	7
Headsets.....	7
<b>SUPPORTING DOCUMENTATION.....</b>	<b>8</b>
Accessing the Web Configuration Tool Online Help.....	8
Accessing Other Documentation .....	8
<b>CUSTOMIZING YOUR PHONE .....</b>	<b>9</b>
MENU Key Menu Interface.....	9
Web Configuration Tool.....	9
Web Configuration Tool Accounts and Passwords .....	9
Accessing the Web Configuration Tool .....	10
Selecting Menu Options.....	10
Entering Numbers and Letters.....	10
Ringer Volume Control .....	11
Handset Volume Control.....	11
Speaker Volume Control.....	11
Display Language .....	12
<b>PERSONAL KEYS.....</b>	<b>13</b>
Line Keys.....	13

Pre-assigned Personal Keys .....	14
Program a Speed Dial Key .....	14
Delete a Speed Dial Key.....	15
Editing Speed Dial Numbers and Labels .....	15
Using Your IP Phone with Mitel Unified Communicator Express.....	16
<b>MAKING AND ANSWERING CALLS.....</b>	<b>17</b>
Dial by Number .....	17
Dial by Name .....	17
Dial by SIP URL or IP Address.....	17
Dial by Phone Book Entry.....	17
Dial by Call Logs Entry .....	18
Redial.....	18
Answering Calls.....	18
Answer a Call.....	19
Auto Answer.....	19
Answer a Call Waiting.....	19
Calling and Called Party Display .....	19
<b>CALL HANDLING.....</b>	<b>20</b>
Hold .....	20
Hold a Call .....	20
Retrieve a Call from Hold.....	20
Change On-Hold Settings.....	20
Call Forward .....	20
Program Call Forward.....	20
Enable/Disable Call Forward .....	21
Call Transfer .....	21
Transfer a Call to an Unconnected Third Party .....	22
Transfer a Call to a Third Party Already on Hold.....	22
Conference Call (Three-Way).....	22
Add a Third Party to a Call in Progress .....	22
Add a Party On Hold to a Call in Progress .....	23
Leave a Conference Call .....	23
Return to a Conference Call after Accepting an Outside Caller .....	23
Messages - Advisory .....	23
Create an Advisory Message.....	23
Enable/Disable your Advisory Message .....	23
Messaging – Voice Mail.....	24

Access your Voice Mail Messages .....	24
<b>USING ADVANCED FEATURES .....</b>	<b>24</b>
Do Not Disturb .....	24
Enable/Disable Do Not Disturb Using the Phone .....	24
Using a Do Not Disturb Key for Quick Enable/Disable .....	25
Call Logs.....	25
View a Call Log Entry .....	25
Delete a Call Log Entry.....	25
Call a Call Logs Entry .....	26
Handset, Handsfree and Headset Modes.....	26
Switch between Handset and Handsfree .....	26
Switch between Handset and Headset.....	26
Switch between Headset and Handsfree .....	26
Muting a Call.....	27
Phone Book .....	27
Create a Phone Book Entry .....	27
Modify a Phone Book Entry .....	27
Delete a Phone Book Entry .....	28
Call a Phone Book Entry.....	28
RSS Feed .....	28
Enable/Disable RSS Feed .....	28
Shared Lines and Keys.....	29
Shared Lines and Keys Programming Requirements .....	29
Programming Shared Line Keys.....	35
Shared Line Key Status .....	36
Programming Busy Lamp Field Keys .....	37
Time and Date .....	43
Change the Time and Date.....	43
Call Forking.....	44
<b>ADMINISTRATOR TOOLS.....</b>	<b>44</b>
SIP Administrator Phone Passwords.....	44
Change Phone Passwords .....	44
SIP User Accounts.....	45
Configure/Modify a SIP User account.....	45
View Prime User Name .....	45
Device Parameters .....	45

Access Protocols .....	45
Enable/Disable Protocols.....	46
Network Settings.....	46
View the IP and MAC Addresses.....	46
Modifying Network Settings .....	46
Upgrade the Phone’s Firmware .....	47
View the Firmware Version.....	47
Upgrading the Firmware .....	48
Automating Firmware Upgrades.....	48
SRTP Call Encryption Indicator .....	48
Line Types .....	48
Voice Mail .....	49
Configuring Voice Mail.....	49
Adjust for Daylight Savings Time.....	49
Additional Settings.....	49
Configuration Files.....	50
Hot Line.....	50
Media Configuration.....	50
Main Program and Boot Program Configuration Options .....	50
Global RSS Feed.....	50
<b>SPECIFICATIONS .....</b>	<b>50</b>

## Getting Started

In SIP mode, the Mitel® 5320, 5330 and 5340 IP Phones manage their own call states and features. SIP uses the Internet to connect your phone to other SIP phones. You can make calls on the Public Switched Telephone Network (PSTN), or “regular”, phone network. You can also call other SIP phones by dialing SIP URL or IP address. If you are registered with a SIP Service Provider, you may also be able to dial by user ID name or extension number.

For information about programming features on your SIP-supported phone, refer to this guide and to the Web Configuration Tool online Help (see *Supporting Documentation* on page 8).

## SIP User Accounts and Passwords

Your Administrator usually configures SIP accounts for SIP phone Users and Administrators. You need a SIP User account in order to

- Register your phone with your SIP Service Provider
- Make calls by dialing a user ID name or extension number

If you do not have a SIP user account, you can still use your phone with limited access to SIP features and functionality.

## SIP Administrative Mode

Administrators need an administrator user account and password to

- Modify network configuration settings and SIP Service Provider information
- Access SIP setting menus through the phone’s MENU Key interface and Web Configuration Tool Administrator pages.

See *Administrator Tools* on page 44 for more information.

## About your SIP Phone

The Mitel 5320, 5330 and 5340 IP Phones are full-feature, dual port, dual mode enterprise-class telephones that provide voice communication over an IP network. They both feature a large graphics display (160 x 320) and self-labeling keys. The 5320 IP Phones offers 8 programmable multi-function keys, the 5330 IP Phone offers 24 programmable multi-function keys, and the 5340 IP Phone offers 48 programmable multi-function keys for one-touch feature access. These phones provide ten fixed feature keys for convenient access to features such as Conferencing, Redial, and many customizable user settings as well as navigational keys to access various screens and application layers. The 5330 and 5340 IP Phones also feature a Unified Communicator (UC) Express application, which is a PC-based desktop programming tool, that allows you to easily configure your phone from your Personal Computer (PC).

For more key and feature information, see *Elements of Your Phone* on page 3.



Figure 1. The 5320 SIP Phone



Figure 2. The 5330 SIP Phone











Figure 3. The 5340 SIP Phone

Table 1: Elements of Your Phone

Feature	Function
1) Display	Provides a large, high-resolution viewing area that assists you in selecting and using phone features.
2) Ring/Message Indicator	Flashes to signal an incoming call and to indicate a message waiting in your voice mailbox.
3) Volume, Speaker and Mute Controls	<p>Provide the following audio control capability:</p> <p> (UP) and  (DOWN) provide volume control for the ringer, handset, and handsfree speakers.</p> <p> (SPEAKER) enables and disables Handsfree mode.</p> <p> (MUTE) enables Mute, which allows you to temporarily turn your phone's handset, headset or handsfree microphone off during a call.</p>

Feature	Function
4) Fixed Function Keys	<p>Give you access to the following phone functions:</p> <p> <b>(MENU)</b> : provides access to menus for your phone's additional features.</p> <p> <b>(CANCEL)</b> : ends a call when pressed during the call, and, when you are programming the phone, eliminates any input and returns to the previous menu level.</p> <p> <b>(REDIAL)</b> : calls the last number dialed.</p> <p> <b>(HOLD)</b> : places the current call on hold.</p> <p> <b>(TRANS/CONF)</b> : initiates a call transfer or establishes a three-party conference call.</p> <p> <b>(MESSAGE)</b> : provides access to your voice mailbox and flashes to notify you of messages waiting in your voice mailbox. Note : The Ring/Message indicator also flashes when messages are waiting.</p>
5) Keypad	Use to dial.
6) Navigation Page Keys	Use to display additional pages of information. The 5320 and 5330 have two page navigation keys: Back and Next. The 5340 has three page navigation keys: Back, Next, and Home.
7) Programmable Feature Keys and Softkeys	Provides 8 (on the 5320), provides 24 (on the 5330), and 48 (on the 5340) self-labeling keys that can be programmed as Speed Dial keys, feature keys, or line appearance keys, according to your communication needs. On your home page, the two bottom right feature keys are always your Prime Line keys on a 5340 IP Phone; and the two bottom left feature keys are always your Prime Line keys on the 5330 and 5320 IP Phone. The top three keys on each side are softkeys.
8) Handsfree Speaker	Provides sound for Handsfree calls and background music.
9) Handset	Use for handset calls. If you are in headset or handsfree mode, you do not need to use the handset.

## TIPS FOR YOUR COMFORT AND SAFETY

### Don't cradle the handset!

Prolonged use of the handset can lead to neck, shoulder, or back discomfort, especially if you cradle the handset between your ear and shoulder. If you use your phone a lot, you may find it more comfortable to use a headset. See the section on headset usage elsewhere in this guide for more information.

### Protect your hearing

Your phone has a control for adjusting the volume of the handset receiver or headset. Because continuous exposure to loud sounds can contribute to hearing loss, keep the volume at a moderate level.

### Adjust the viewing angle

The stand built into your phone tilts to give you a better view of the keys.

To tilt your telephone for better viewing:

1. Turn the phone so that the front faces away from you.
2. Hold the base unit firmly and press the release tabs on the sides of the stand to detach the base unit.
3. Hinge the hooks of the base unit into the notches on the back of the phone and snap into place as follows:
  - a. For a high-angle mount, hinge the two lower hooks into the bottom set of notches and snap the two upper hooks into the middle set of notches.
  - b. For a low-angle mount, hinge the two lower hooks into the middle set of notches and snap the two upper hooks into the top set of notches.

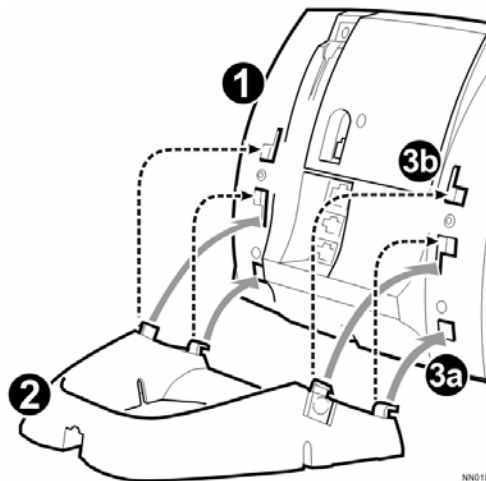

NN0183

## Using Your Default Phone Window And Keys

The 5330 and 5340 IP Phone default phone windows and keys are shown and described below. The Phone window provides access to programmable keys and the main phone interface.

The 5320 IP Phone default phone window (not shown) is very similar to the 5330, except the page navigation keys are non-functional for the 5320. Also, the 5320 has a black bezel instead of a silver one.

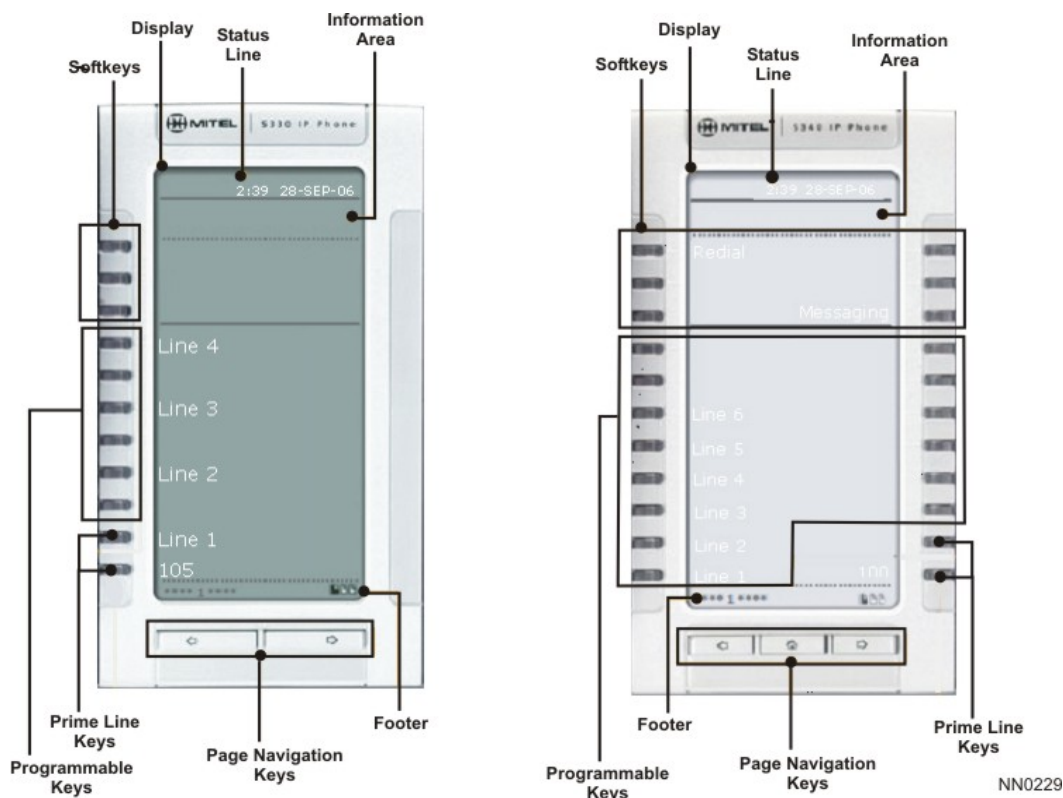

Figure 4: 5330 and 5340 IP Phone Windows

Table 2: 5320, 5330 and 5340 IP Phone Default Window and Keys

Feature	Function
Softkeys	Provide prompts in most phone applications. These are non-programmable feature keys that are specific to the application or state of the set. The 5330 provides three softkeys and the 5340 provides six softkeys.
Programmable Keys	Launch specific call control features. Use the <b>MENU</b> key or the Web Configuration Tool to program these keys. The 5340 provides 16 programmable keys per page (a maximum of 46 programmable keys plus the Prime Line keys). The 5330 provides 8 per page (a maximum of 22 programmable keys plus the Prime Line keys). The 5320 provides 6 programmable keys, plus two Prime Line keys.
Page Navigation Keys	Display additional pages of information. The 5330 has two page navigation keys: <b>Back</b> and <b>Next</b> , while the 5340 has three page navigation keys: <b>Back</b> , <b>Next</b> , and <b>Home</b> . (The 5320 does not support page navigation keys.)
Status Line	Displays time and date.

Feature	Function
Information Area	Provides information about the current state of the set. For example, if Do Not Disturb is enabled, the message *DND ON* appears here. This area also displays the RSS feed, if programmed. The second line of the information area displays the user name for the set.
Footer	Shows Page Indicator.

## Call Encryption Indicator

The 5320, 5330 and 5340 IP Phones automatically provide Secure Real-time Transport Protocol (SRTP) voice encryption when connected to a phone that also supports SRTP. A “secured call” icon (closed padlock) appears on the display for encrypted calls, and for conference calls in which all connected parties support SRTP. An “unsecured call” icon (open padlock) appears on the display when the call connection is not secured (the connected party or parties do not support SRTP encryption). For an icon to appear, SRTP must be enabled. You can enable SRTP on your phone using the Feature Configuration page of the Web Configuration Tool. (See Accessing the Web Configuration Tool Online Help on page 8.)



**Note:** The padlock icon appears only when you are speaking to a party; it does not appear if you receive a busy signal.

## Accessories for Your Phone

### Headsets

The 5320, 5330 and 5340 IP Phones support Mitel-approved headsets with a Feature Control Switch. Install the headset only in the dedicated headset jack on the back of the phone. Installation disables your handset microphone. Disconnecting the headset at the jack or at the quick-disconnect plug restores handset operation.

## Supporting Documentation

### Accessing the Web Configuration Tool Online Help

To access programming instructions in the Web Configuration Tool online Help:

1. Access the Web Configuration Tool Home Page (see Accessing the Web Configuration Tool on page 10 ).
2. Scroll to the bottom of the page.
3. In the left pane, under **Support**, click **Help**. The Help system opens, presenting links to the User Web Configuration Tool online Help and to this guide.



**Note:** If you have administrative privileges, you will have access to both the User and the Administrator Web Configuration Tool online Help systems.

### Accessing Other Documentation

To access other Mitel phone and peripheral documentation:

1. In your browser, go to **www.mitel.com**
2. Click **Resources**.
3. From the Documentation list, select **Guides** and then click User Guides.

## Customizing Your Phone

To customize and use your phone features, use either of the following two interfaces:

- MENU Key Menu Interface
- Web Configuration Tool

### MENU Key Menu Interface

The fixed-function keys provide access most features on your phone. The phone's Settings menu interface provides access to additional features.

To access the Settings menu interface, press the **MENU** key  .

### Web Configuration Tool

The Web Configuration Tool is an optional tool that you can use in addition to your phone to make calls and to personalize and modify your phone settings.

You can access the Web Configuration Tool from any personal computer (PC) connected to the Internet and running a web browser that is one of the following:

- Netscape Navigator 4.8 or later
- Internet Explorer 4 or later
- Any equivalent browser

 **Note:** If your network is protected by a firewall, you may not be able to access your phone using the Web Configuration Tool from outside the firewall.

### Web Configuration Tool Accounts and Passwords

You must have either a User or Administrator account to access the tool. Your account determines the type of web configuration pages you can access when you connect to the phone.

Your Administrator may change the default user name and password settings. If necessary, obtain your new user name and password from your Administrator.



**Table 3: Web Configuration Tool Default User Names and Passwords**

	Default User Name	Default Password (5320 and 5330 IP Phone)	Default Password (5340 IP Phone)
<b>User</b>	user	hello	hello

 **Note:** For Administrator default user name and password, see *Administrator Tools* on page 44.

## Accessing the Web Configuration Tool

To access the Web Configuration Tool:

1. On your phone, do the following to obtain your phone's IP address:
  - Press the **MENU**  key.
  - Press the **Line 1** (Prime Line) key. Your phone's IP address appears in the Information area.
  - Write down the IP address, and then press the **MENU**  key to return to the default display.
2. On your PC, launch your browser.
3. In your browser's **URL** or **Address** field, enter your phone's IP address. The Web Configuration Tool login screen appears.
4. In the appropriate fields, enter your Web Configuration Tool user name and password.
5. Click **OK**. The Web Configuration Tool *Home Page* launches.

 **Note:** If you are a SIP Administrator, see *Administrator Tools* on page 44 for administrative options.

 **Note:** If you need help programming features, access the online help system in the Web Configuration Tool (see *Accessing the Web Configuration Tool Online Help* on page 8).

## Selecting Menu Options

On the 5320, 5330 and 5340 IP Phones, press the corresponding softkeys to select menu items on the display.

## Entering Numbers and Letters

Depending on the context, the 5320/5330/5340 IP Phone's keypad allows you to enter only numbers, or numbers, letters, and some special characters. You can dial

- Extension numbers
- Phone numbers (PSTN numbers)
- IP addresses
- SIP URLs
- User ID names

Letters correspond to those on the keypad, and characters to below. A flashing cursor indicates the position of the character you are entering. The cursor automatically advances after one second, or when you press a different keypad key.

To enter letters and special characters:

- Rapidly press the appropriate number key until the desired character appears on the display.



To enter an uppercase letter:

- Press  (UP) before entering the letter. Press  (DOWN) to return to lowercase mode.

To delete the character last entered:



- Press the <— softkey.

**Table 4: Letter and Character Entry**

Dial Pad Key	Press								
	Once	Twice	3 Times	4 Times	5 Times	6 Times	7 Times	8 Times	9 Times
	1	space	?	!	~				
	2	a	b	c					
	3	d	e	f					
	4	g	h	i					
	5	j	k	l					
	6	m	n	o					
	7	p	q	r	s				
	8	t	u	v					
	9	w	x	y	z				
	0	+	&	%	\$	\	“		
	*	.	=	:	/	;	,	—	—
	#	@	(	)	[	]	<	>	



## Ringer Volume Control

To adjust the ringer volume control:

- When the phone is ringing, press  (UP) or  (DOWN)

## Handset Volume Control

To adjust handset volume:



- When the handset is in use, press  (UP) or  (DOWN)

## Speaker Volume Control

When on a handsfree call, press  (UP) or  (DOWN)

## Display Contrast Control

To adjust display contrast:

- When the phone is idle, press  (**UP**) or  (**DOWN**)

## Display Language

Your Administrator sets the display language using the Administrator Web Configuration Tool.

## Personal Keys

Personal keys provide one-touch access to the following features:

- Speed Dial (Memory Keys)
- Shared Lines
- Line Keys
- Call Logs
- Phonebook
- Forwarding
- Do Not Disturb
- Advisory Message
- PC Application
- Headset On/Off
- RSS Feed
- HTML Application

You can program any Personal key that isn't a prime line key. For example, you can program a key as a Speed Dial for one-touch dialing. You can also view, modify, or delete the information programmed on any Personal key except Line 1 and Line 2.



**Note:** You cannot change your Personal key settings while on a call.



**Note:** You can use the Web Configuration Tool to easily program, edit, and delete programmable key information. For key programming settings, instructions, and phone layouts, refer to the About the Key Programming Page topic in the Advanced Features section of the Web Configuration tool online help. Also see *Using Advanced Features* on page 24. Instructions for programming personal keys using the phone itself are supplied in the following sections.

For information about programming shared line keys, see *Shared Lines and Keys* on page 29.

## Line Keys

Line keys allow you to make and answer calls according to line or caller information. The 5320, 5330 and 5340 IP Phones have four Line keys. If one line is busy, incoming calls are received on the next available Line key. Each phone has a pre-assigned Prime Line (Line 1) key.

## Pre-assigned Personal Keys

Your SIP phone has the following pre-assigned personal keys on the Page 1 display:

Pre-assigned Value	Key Location	
	5320/5330 IP Phone <sup>1</sup>	5340 IP Phone <sup>2</sup>
Line Keys	Keys 1 - 4	Keys 1 - 4 (right)
	(Keys 1 and 2 are Prime Lines)	
Weather	Key 5	Key 5 (left)
Headset on/off	Key 6	Key 6 (left)
Advisory Message	Key 7	Key 7 (left)
Call Logs	Key 8	Key 8 (left)

1. On the 5320/5330 IP Phone, count from the bottom to top on the single row of keys.

2. On the 5340 IP Phone, count from the bottom to top on both rows of keys.

## Program a Speed Dial Key

You can use the Web Configuration Tool to easily program, edit, and delete programmable key information, but you can also use the Settings application on the phone.

To program a **Personal** key as a Speed Dial key directly on the phone:

1. Press **MENU** , and then press **>>** until PROGRAM MEMORY KEYS? appears.
2. Press **OK**. SELECT A KEY appears.
3. Press the Personal key you want to program. If the key has been previously programmed, the programmed information appears. If the key is not programmed, UNUSED KEY appears.
4. Do one of the following:
  - If the selected key is currently programmed as a Speed Dial key and you want to replace the current programming, do one of the following:
    - To replace the current name AND label, press **Delete**. ENTER NUMBER appears.
    - To replace the number and keep the label, press **Edit**. ENTER NUMBER appears.
  - If the selected key is currently programmed as a different feature, MDFY TO SPEEDIALKEY appears. If you want to reprogram the key as a Speed Dial key, press **Yes**. ENTER NUMBER appears. (To exit and select a different key, press **No**.)
  - If the selected key is not currently programmed, press **Add New**. ENTER NUMBER appears.
5. Do one of the following:
  - If you want to enter a name, press **Name**.
  - If you want to enter a SIP URL or an IP address, press **URL**. Press **<—** to delete characters.
6. Enter the destination Number, Name, or URL. The key is automatically labeled with the information you have entered.

7. Press **Save**. KEY SAVED appears.
8. Press **OK**. PROGRAM MEMORY KEYS? appears.
9. Do one of the following:
  - To program additional Speed Dials, press **OK**.
  - To return to the default display, press **MENU** .



 **Note:** If the number you are calling requires an intermediate Long Distance Carrier number to be dialed before the phone number, you can program a Speed Dial number for the Carrier. After pressing the Speed Dial number for the carrier, press the Speed Dial number for the party you are calling.

 **Note:** If the Speed Dial number you want to program requires pauses (for example, if you normally dial a main number, wait for a prompt, and then dial an extension) you can program them into a Speed Dial key by entering a comma to represent a one-second pause. For example, to dial main number 592-2122 and then enter extension 111 after a 3-second pause, program a Speed Dial number as follows: 5922122,,,111

## Delete a Speed Dial Key

The Web Configuration Tool provides full add/edit/delete functionality, but you can also use the phone itself.

To delete a Speed Dial key using the phone:

1. Press **MENU** , and then press **>>** until PROGRAM MEMORY KEYS? appears.
2. Press **OK**. SELECT A KEY appears.
3. Press the Personal key you want to delete. The associated programming appears.
4. Press **Delete**.
5. Press **Yes**. UNUSED KEY appears.
6. Do one of the following:
  - To return to the Features menu, press **Exit**.
  - To return to the default display, press **MENU** .

## Editing Speed Dial Numbers and Labels

Speed dial labels are automatically applied during initial programming. If a speed dial number is edited, however, the label will not change. To edit both the Speed Dial number and the label from the phone, delete the Speed Dial key to clear the key and label, and then enter the new Speed Dial number/URL.

You can edit feature key labels (including Prime Line key labels) at any time using the *Key Programming* page of the Web Configuration Tool.

## Using Your IP Phone with Mitel Unified Communicator Express

When used with Unified Communicator® Express or Unified Communicator Advanced 3.0 applications, the 5320, 5330 or 5340 IP Phones becomes a powerful communications tool that helps customers streamline communications between people and organizations. This leads to improved productivity, enhanced customer service, reduced costs, and ultimately improved business process integration.

## Making and Answering Calls

You can make and receive calls using the handset, headset or handsfree speaker. You can dial by extension number or phone number, user ID name, SIP URL, or IP address. You can also dial a Call Logs or Phonebook entry.

If you are registered with a SIP Service Provider and want to dial a “regular” phone number, your SIP Service Provider must provide access to the PSTN. To dial a SIP user name or extension number, you must be registered with a SIP Service Provider. For more information, contact your Administrator.

### Dial by Number

1. Lift the handset (optional).
2. If you want to use a line other than **Line 1**, press a **Line** key.
3. Do one of the following:
  - Dial the number.
  - Press a **Speed Dial** key.
  - Press **123**  (**REDIAL**). (See [Redial](#) on page 18.)

### Dial by Name

To dial by a user ID name, you must be registered with a SIP Service Provider.

1. Lift the handset.
2. Press **Name**.
3. Enter the Name of the party you want to call.



**Note:** If the name has more than 20 characters, only the last 20 characters appear on the display.

4. Press **Dial** or **#** (the pound key).

### Dial by SIP URL or IP Address

1. Lift the handset (optional).
2. Press **URL**, then enter the SIP URL or IP address of the party you want to call.





**Note:** If the SIP URL exceeds 20 characters, only the last 20 characters appear.

3. Press **Dial** or **#** (the pound key).



### Dial by Phone Book Entry

1. Press MENU , and then press >> until PHONE BOOK? appears.
2. Press OK. PHONE BOOK <number of items> appears on the display.



3. Press  (UP) and  (DOWN) to navigate to the entry you want to call.
4. Press Dial or # (the pound key).
5. Lift the handset (optional).

 **Note:** To dial from your Phone Book using the Web Configuration Tool, access the tool's Phone Book page (see Accessing the Web Configuration Tool on page 10).

### Dial by Call Logs Entry

1. Press **MENU** , and then press >> until CALL LOGS? appears.
2. Press **OK**, and then press **Next** or **Prev** to navigate to the desired log type (Missed Calls, Answered Calls, or Outgoing Calls).
3. Press **OK**. The number of calls appears.
4. Press  (UP) and  (DOWN) to navigate through the logged call entries.
5. Do one of the following:
  - Press **Dial** or # (the pound key) to call this log entry. The log is dialed and the phone returns to the default display.
  - Press **Detail** to see calling name and time details.
  - Press **Delete** to delete the current log entry.

### Redial

1. Lift the handset (optional).
2. Press  (REDIAL). The last number you dialed appears in the display.
3. Do one of the following:
  - Press **Dial** to dial this number
  - Press  (REDIAL) to scroll the list of previously-dialed numbers and then press Dial when the desired number is displayed.

 **Note:** The redial list is maintained even after the phone reboots and is updated periodically. If a power failure occurs during the update, it is possible that one or more previously-dialed numbers may be lost.

## Answering Calls

Incoming calls ring **Line 1**, if all lines are free, or the next available line. If all lines are busy and Call Forward – Busy is not enabled (see Enable/Disable Call Forward on page 21), callers hear a busy signal.

When the phone rings, the Ring/Message Indicator and the associated Line key flash, and the name of the caller appears in the information area.



## Answer a Call

To answer a call, do one of the following:

- In handset mode, lift the handset.
- In headset mode, press the **Headset** key, then press the flashing **Line** key.
- In handsfree mode, press  (**SPEAKER**), or press the flashing **Line** key.

For more information about handset, handsfree (Speaker), or headset calls, see *Handset, Handsfree and Headset Modes* on page 26.

## Auto Answer

You can use Auto Answer to automatically answer incoming calls in handsfree or headset mode.

To enable or disable Auto Answer:

- Access the Feature Configuration page of the Web Configuration tool (see *Accessing the Web Configuration Tool* on page 10).

To answer an Auto Answer call:

- Begin speaking when the call arrives.

To end an Auto Answer call, do one of the following:

- Press  (**CANCEL**).
- Wait for the caller to hang up.

## Answer a Call Waiting

The 5320, 5330 and 5340 IP Phones allow a default quantity of three calls waiting while you are on a call. New calls wait on the next free line. When a new call arrives, you hear a call waiting tone, the name of the new caller appears, and the corresponding **Line** key flashes. If all lines are busy, callers hear a busy signal. (Number of calls waiting is dependent upon the number of Line keys you have programmed.)

To answer a waiting call:

- Press the flashing Line key of the call waiting. The current call is put on hold, and you are connected to the new caller.

To return to the original call:

- Press the associated flashing **Line** key.

## Calling and Called Party Display

SIP phones display the true (programmed) identity of the called/calling party rather than the standard number/name display.

## Call Handling

### Hold

The 5320, 5330 and 5340 IP Phones support a maximum of four simultaneously held calls.

When you place a call on hold, or when another party puts you on hold, the on-hold beep reminds you that you are holding or on hold. If the handset is in its cradle, you hear the beep through the handsfree speaker. You can disable this beep if desired, using the Web Configuration Tool.



**Note:** The call hold tone takes precedence over Music On Hold.

#### Hold a Call

- Press  (**HOLD**). The associated **Line** key flashes.

#### Retrieve a Call from Hold

- Press the associated flashing **Line** key. The **Line** key changes from flashing to lit solid.

#### Change On-Hold Settings

- Access the Feature Configuration page of the Web Configuration (see Accessing the Web Configuration Tool on page 10). **Note:** You cannot change your hold settings while in a call.

### Call Forward

Call Forward redirects incoming calls to your voice mailbox (by default) or to an alternate number. Choose from the following Call Forward options:

- **Call Forward – Always** redirects all incoming calls
- **Call Forward – No Answer** redirects calls if you don't answer after the programmed number of rings (1 – 10)
- **Call Forward – Busy** redirects calls when all lines are busy.





**Notes:**

- All Call Forward options are OFF by default.
- You can turn on Call Forward No Answer and Call Forward Busy at the same time.
- You cannot change your Call Forward settings while in a call.



To program, enable, or disable Call Forward using the Web Configuration Tool, access the *Feature Configuration* page (see *Accessing the Web Configuration Tool* on page 10).

#### Program Call Forward

1. Press **MENU** , and then press >> until Features? appears.

2. Press **OK**. CALL FORWARDING? appears.
3. Press **OK**. FWD ALWAYS: <current status> appears.
4. Press **Next** or **Prev** to navigate to the desired Call Forward option.
5. Press **OK** to select the desired Call Forward option.
6. Press **Review**. The current forwarding destination appears. If no forwarding is programmed, the top line of the display is blank.
7. For the Call Forward - No Answer option only, press **Options** and enter the desired number of rings (1 – 10) before a call is forwarded.
8. Press **Save** and then press **OK** to re-enter programming mode.
9. Press **Change**, and then do one of the following:
  - To enter a URL as the destination, press **URL**, and then enter the URL.
  - To enter a name as the destination, press **Name**, and then enter the name.
10. Press **Save**. After the information is saved, the Call Forwarding option appears in the display with its new status. Note: You can disable this display using the Display Control section of the Feature Configuration page of the Web Configuration Tool.
11. Do one of the following:
  - To return to the main menu, press **Next** or **Prev** until FWD BUSY displays, and then press **Exit**.
  - To return to the default display, press **MENU** .

### Enable/Disable Call Forward

1. Press **MENU** , and then press **>>** until **Features?** appears.
2. Press **OK**. CALL FORWARDING? appears.
3. Press **OK**. FWD ALWAYS: <current status> appears.
4. Press **Next** or **Prev** to navigate to the desired Call Forward option.
5. When the desired Call Forwarding option appears, press **TurnOn** or **TurnOff** to enable or disable the Call Forwarding option. The Call Forwarding option and its new status appear on the display, if the display option is enabled on the Feature Configuration page of the Web Configuration Tool.
6. Press **OK**, and then press **MENU**  to return to the default display.





## Call Transfer

You can transfer an active call to another party (one line must be free on your phone). The 5320, 5330 and 5340 IP Phones support four lines. If all lines are busy on your phone, no calls can be transferred.





**Note:** During a conference call, any party can perform a call transfer when one line on the phone that initiated the conference call is not in use. For conference call information, see *Conference Call (Three-Way)* on page 22.

### Transfer a Call to an Unconnected Third Party

1. While on a call, press  (TRANS/CONF). The call is put on hold.
2. Press a free **Line** key.
3. Call the party to whom you want to transfer the call, and then do one of the following:
  - To talk to this party, wait until the connection is established, speak to the party, press , and then hang up.
  - To transfer the call without speaking to this party, immediately press  (TRANS/CONF), and then hang up. The held call will be transferred to the call in progress.
  - To cancel the transfer, press  (CANCEL). You are returned to the held call.

### Transfer a Call to a Third Party Already on Hold



1. While on a call, press  (TRANS/CONF). The call is put on hold.
2. Press the **Line** key of the call on hold, and then press  (TRANS/CONF).
3. Hang up.

## Conference Call (Three-Way)

When two parties are connected on a call, either of those parties can originate a three-way conference by adding a third party to the call in progress. Once three parties are connected, no more parties can be added to that call.

A party can be involved in more than one three-way conference call at a time, but the calls cannot be merged. For example, A and B are on a call. A adds C to create three-way conference call ABC. B adds D to the call with A to make conference call ABD. ABC and ABD remain separate—D is not added to conference call ABC.



### Add a Third Party to a Call in Progress

1. Press  (TRANS/CONF). The current call is put on hold.
2. Press a free **Line** key, and then do one of the following:
  - Dial the number.
  - Press a **Speed Dial** key.
  - Press  (REDIAL).
3. Press **Conf**. The call you put on hold in step 1 is now connected to the call in progress.

 **Note:** If the new party does not answer, press  (CANCEL) twice to return to the held party.

 **Note:** Each conference member (other than the conference initiator) may initiate another three-way conference.

## Add a Party On Hold to a Call in Progress

1. Press  (TRANS/CONF). The current call is put on hold.
2. Press the **Line** key of the party already on hold.
3. Press  (TRANS/CONF). The call put on hold in step 1 is connected to the call in progress.

## Leave a Conference Call

Do one of the following:

- Hang up.
- Press  (CANCEL).



**Note:** If any party in a conference call hangs up, the other parties remain connected.

## Return to a Conference Call after Accepting an Outside Caller

If the originator of a conference responds to a call from another party during a conference, the other two conference members are put on hold.

To resume the conference, the originator must:

1. Select one of the held lines and then press  (TRANS/CONF).
2. Select the remaining held line and then press the **Conf** softkey.

## Messages - Advisory



An advisory message about your whereabouts appears on your caller's display.

### Create an Advisory Message

- Access the Feature Configuration page of the Web Configuration Tool (see Accessing the Web Configuration Tool on page 10).

### Enable/Disable your Advisory Message

To enable or disable an advisory message:

1. Press **MENU** , and then press **>>** until **Features?** appears.
2. Press **OK**, and then press **Next** or **Prev** until ADVISORY MESSAGE? appears.
3. Press **OK**. The first of several advisory messages appears.
4. Press  (**UP**) or  (**DOWN**) to navigate to the desired message.
5. Press **TurnOn** or **TurnOff** to enable or disable the message. When enabled, the **Advisory Message** appears in the information area of the phone display.

6. Do one of the following:
  - To return to the Features menu, press **Exit**.
  - To return to the default display, press **MENU**  .

 **Note:** To enable/disable advisory messages using the Web Configuration Tool, access the tool's *Feature Configuration* page (see page 10).

## Messaging – Voice Mail

Your Administrator configures your voice mail information so you can receive and access voice mail messages. The Ring/Message Indicator flashes to indicate waiting messages.

 **Note:** For administrative information about voice mail, see Voice Mail on page 49.

### Access your Voice Mail Messages



1. Lift the handset (optional).
2. Press  (**MESSAGE**) and enter your voice mailbox number.
3. Follow the voice mailbox prompts.

## Using Advanced Features

### Do Not Disturb

Do Not Disturb (DND) forwards all calls directly to your voice mailbox so that a ringing phone will not disturb you. If Do Not Disturb is enabled and you do not have a voice mailbox set up, callers hear a busy signal.

### Enable/Disable Do Not Disturb Using the Phone

1. Press **MENU** , and then press >> until **Features?** appears on the display.
2. Press **OK**, and then press **Next** until DO NOT DISTURB? appears.
3. Press **OK**. DO NOT DISTURB <current status> appears.
4. Press **TurnOn** or **TurnOff** to enable or disable Do Not Disturb. After the information is saved, DO NOT DISTURB <new status> appears.
5. Do one of the following:
  - To return to the Features menu, press **Exit**.
  - To return to the default display, press **MENU**  .

 **Note:** When Do Not Disturb is enabled, **\*DND ON\*** alternates with other information in the phone's information display area. If both Call Forward and Do Not Disturb are on, **\*DND ON\*** and **\*FWD ON\*** both display. You can disable this display using the *Display Control* section of the Feature Configuration page of the Web Configuration Tool.

## Using a Do Not Disturb Key for Quick Enable/Disable

1. Access the *Key Programming* page if the Web Configuration Tool and program a DND key.
2. You can enable and disable DND by pressing the DND key. When enabled, the DND is illuminated.





## Call Logs

Call Logs keeps a record of your missed, answered and outgoing calls. The 5330 and 5340 IP Phones log the ten most recent missed, answered, and outgoing calls. The most recent call appears at the top of each log.

Call Logs record calling party name, number, SIP URL or IP address, call duration, and the time and date of each call. When you have missed incoming calls, the number of calls appears in the information display area of your phone's display (for example, \*2 CALLS\*). You can disable this display using the *Display Control* section of the Feature Configuration page of the Web Configuration Tool.

 **Note:** Call log information is saved automatically every 4 hours. If you reset your phone in that 4-hour interval, any call logs generated during that time will not be stored.

### View a Call Log Entry

1. Press **MENU** , and then press **>>** until CALL LOGS? appears.
2. Press **OK**, and then press **Next** to navigate to the desired log type (Missed Calls, Answered Calls or Outgoing Calls).
3. Press **OK**. The number of calls appears.
4. Press  (**UP**) and  (**DOWN**) to navigate through the logged call entries.
5. When the desired entry appears, press **Detail**, and then press **<<** and **>>** to scroll the entry information.
6. When you have finished, press **Done**.
7. Press **MENU**  to return to the default display.



 **Note:** To view Call Log entries using the Web Configuration Tool, access the tool's Call Logs page (see Accessing the Web Configuration Tool on page 10).

### Delete a Call Log Entry

**Note:** You can delete all entries in a Call log using the Delete All button on the Call Logs page of the Web Configuration tool.

To delete selected entries in a call log:

1. Press **MENU** , and then press **>>** until CALL LOGS? appears on the display.
2. Press **OK**, and then press **Next** to navigate to the desired log type (Missed Calls, Answered Calls or Outgoing Calls).
3. Press **OK**. The number of calls appears.

4. Press  (**UP**) and  (**DOWN**) to navigate through the logged call entries.
5. When the desired entry appears, press **Delete**. CONFIRM DELETE? appears.
6. Press **Yes**. The log is deleted.
7. Press **MENU**  to return to the default display.

### Call a Call Logs Entry

- See Dial by Call Logs Entry on page 18 to quickly dial a Call Logs entry.

## Handset, Handsfree and Headset Modes

### Switch between Handset and Handsfree

To go from handset to handsfree mode:

1. Press  (**SPEAKER**).
2. Hang up the handset. Use the handsfree speaker to communicate with your party.

To go from handsfree to handset mode:

- Lift the handset, and use it to communicate with your party.

### Switch between Handset and Headset

To go from handset to headset mode:

1. Press the **Headset** key. The **Headset** key light turns ON.
2. Hang up the handset. Use the headset to communicate with your party.

To go from headset to handset mode:

1. Lift the handset.
2. Press the **Headset** key. The **Headset** key turns OFF. Use the handset to communicate with your party.

### Switch between Headset and Handsfree

To go from headset to handsfree mode:

- Press the **Headset** key, and then press  (**SPEAKER**). The **Headset** key turns OFF. Use the handsfree speaker to communicate with your party.

To go from handsfree to headset mode:

- Press the **Headset** key. The **Headset** key turns ON. Use your headset to communicate with your party.



## Muting a Call

To mute your phone so your party cannot hear you:

- Press  (**MUTE**). The  (**MUTE**) key turns ON.

To turn Mute off and return to the conversation:

- Press  (**MUTE**) again. The  (**MUTE**) key turns OFF.





## Phone Book

The Phone Book is a scrollable list of contacts from which you can make a call. The 5320, 5330 and 5340 IP Phones each hold a maximum of 60 Phone Book contacts.



Phone Book entries contain the contact's name (maximum of 20 characters), and the contact's number, SIP URL, or IP address. To create, modify, or make calls from your Phone Book using the Web Configuration Tool, access the tool's *Phone Book* page (see *Accessing the Web Configuration Tool* on page 10).

 **Note:** You cannot change your Phone Book settings while on a call.

### Create a Phone Book Entry





1. Press **MENU** , and then press >> until PHONE BOOK? appears.
2. Press **OK**. PHONE BOOK: <number of items> appears.
3. Press  (**UP**) and  (**DOWN**) to navigate through the entries until ENTRY EMPTY! appears.
4. Press **AddNew**. PROGRAM ADDRESS? appears.
5. Press **Yes** to enter the number, IP address, or SIP URL of the contact. Press <— to delete characters.
6. Press **Submit**. After the information is saved, PROGRAM NAME? appears.
7. Press **Yes**, and then enter the name of the contact. This name appears in the Phone Book list.
8. Press **Submit**. After the information is saved, the name of the contact appears.
9. Press **MENU**  to return to the default display.

### Modify a Phone Book Entry

1. Press **MENU** , and then press >> until PHONE BOOK? appears.
2. Press **OK**. PHONE BOOK: <number of items> appears.
3. Press  (**UP**) and  (**DOWN**) to navigate to the entry you want to modify.
4. Press **Change**, and then press **Edit**. PROGRAM ADDRESS? appears.

5. Do one of the following:
  - To modify name, IP address, or SIP URL, press **Yes**, edit the information, and then press **Submit**. After the information is saved, PROGRAM NAME? appears.
  - To modify a name, press **No**. PROGRAM NAME? appears. Press **Yes**, edit the name, and then press **Submit**. After the information is saved, the modified name appears in the Phone Book listing.
6. Press **MENU**  to return to the default display.

### Delete a Phone Book Entry

1. Press **MENU** , and then press >> until PHONE BOOK? appears.
2. Press **OK**. PHONE BOOK: <number of items> appears.
3. Press  (**UP**) and  (**DOWN**) to navigate to the entry you want to delete.
4. Press **Change**, and then press **Delete**. CONFIRM DELETE? appears.
5. Press **Confirm**. The entry is deleted, and ENTRY EMPTY! appears.
6. Press **MENU**  to return to the default display.

### Call a Phone Book Entry

- See Dial by Phone Book Entry on page 17 to call a Phone Book entry

## RSS Feed

RSS feeds (or “web feeds”) are text formats used to deliver information such as news and weather reports. Your Mitel SIP Phone can act as an RSS feed reader, displaying the feed on Line 1 of the phone display when the phone is idle. You can program one or more keys on your phone to display an RSS feed or to display your own customized message (branding). Use the [Key Programming Page](#) in the Web Configuration Tool to program one or more RSS feed keys. For more information, refer to the Web Configuration Tool Online Help.

### Enable/Disable RSS Feed

Once an RSS Feed key is programmed, press the key to display the feed. The LED on the key will remain lit while the RSS feed scrolls continuously across Line 1 of your phone display. Press the key again to stop the feed.

 **Note:** If your Administrator has programmed a global RSS feed or branding message for your phone, this text will be displayed when your phone is idle. When one of your own personal RSS Feed keys is enabled, it will override any global feed set by your Administrator for your phone.

 **Tip:** To improve RSS readability, you can disable other displays (like Call Forwarding and Missed Calls). Use the Feature Configuration page of the Web Configuration Tool to set Display Controls.

## Shared Lines and Keys

There are three types of shared lines:

- **SIP:** basic shared line with limited features (supports call forking but does not have LED activity and lines are not linked. This type of shared line is available in normal SIP mode).
- **SIP\_BLA line type:** server-enhanced Sylanro Bridged Line Appearance line type
- **SIP\_SCA line type:** server-enhanced Broadworks Shared Call Appearance line type

BLA and SCA line types allow calls and lines to be shared by multiple users. A SIP server provides support for call presentation to multiple phones, call state notifications, and access control. SIP mode shared lines are shared among users but, normally, only the user who initiates activity on the line has full control over it. For example, if a shared line is in use (not on Hold), and secondary share users press their corresponding line button, the shared line will not change state. If the shared line is Ringing, or on Hold, any share user who presses the corresponding line button will change the state of that call and get connected to the calling/held party. An exception to this scenario occurs when the server is configured to allow line seizure by multiple lines. Mitel SIP phones support multi-call server programming.

Requirements for making calls and picking up held calls from shared lines are the same as for normal (non-shared) lines.

### Shared Lines and Keys Programming Requirements

Before programming the Shared Lines and Keys, the Broadsoft server must be configured with a list of shared users.

The diagram below shows an example of how Mitel Users 1 – 3 have been configured on the Broadsoft server to communicate with 3 Mitel phones. The three lines used on these phones are shared lines; if a call is directed to User 1 then all three phones are alerted. If User 3 answers the call then Line 1 on Phone 1 and Line 2 on Phone 2 indicate an active line.

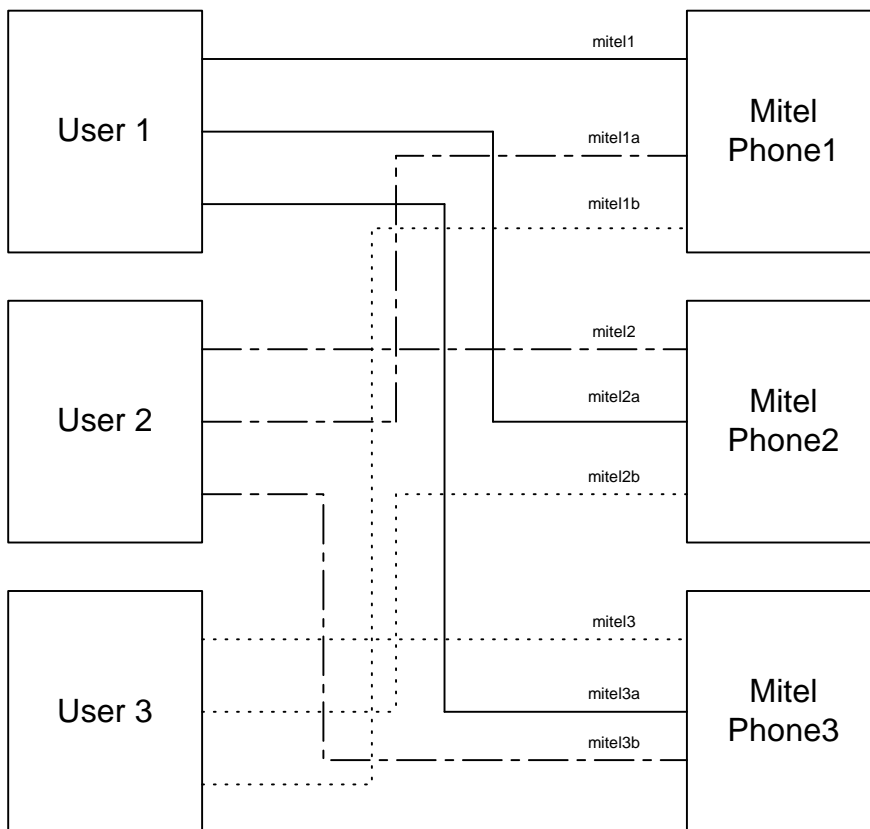

**Figure 5 : Shared Line Keys and User Configuration**

The diagram below reflects the above example, but shows how the User Configuration and Key Programming pages (in the Web Configuration tool) are completed for Shared Line Keys. This example applies to the following procedures describing how to program Shared Line Keys.

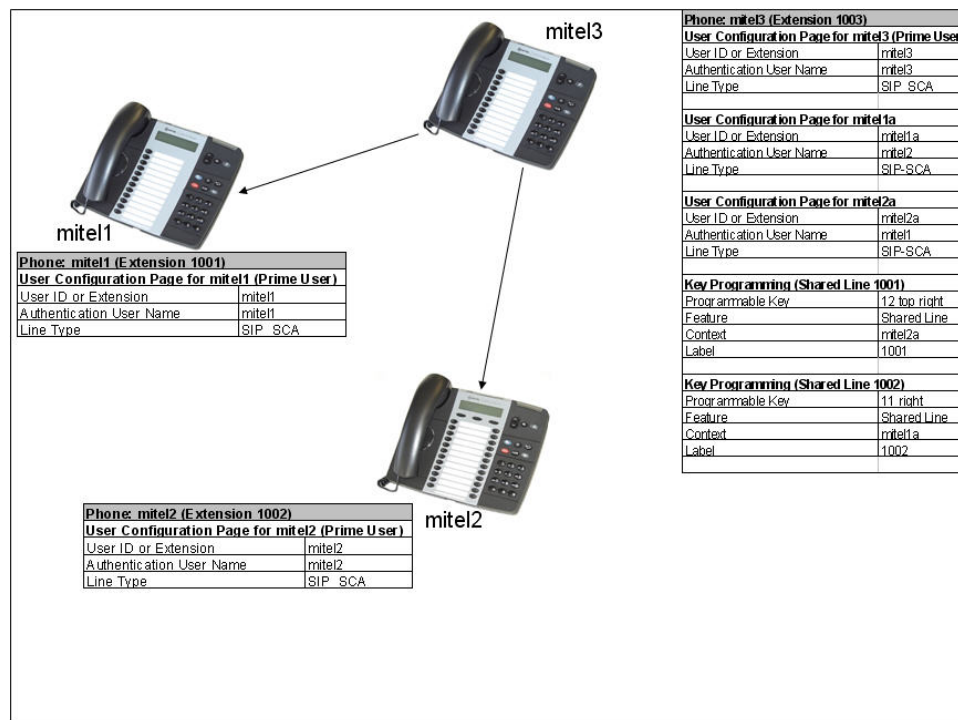
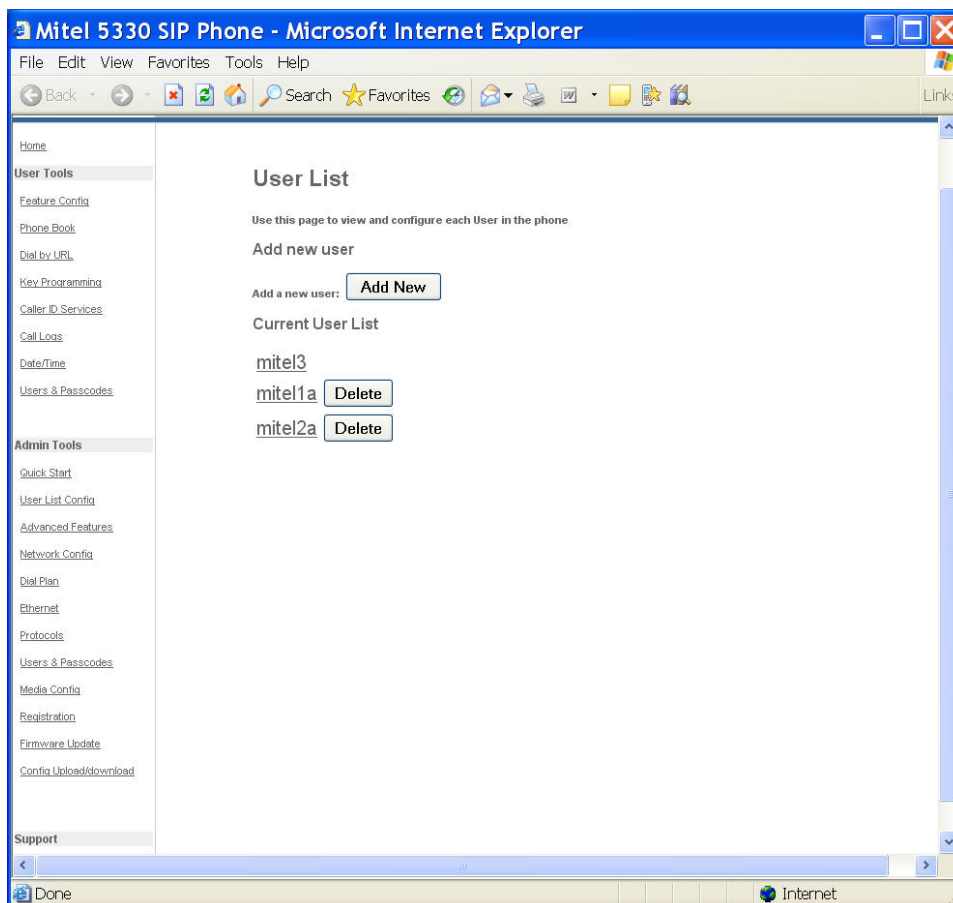

Figure 6: Programming and Configuration of Users and Shared Line Keys

Your Administrator must create a user entry (on the User List Config page of the Web Configuration tool) for the user(s) with whom you want to share a line.



Your Administrator must configure the type of shared line (SIP, BLA, or SCA) in the Line Type field on the User List Config page.

**Mitel 5330 SIP Phone - Microsoft Internet Explorer**

File Edit View Favorites Tools Help

Home

**User Tools**

- Feature Config
- Phone Book
- Dial by URL
- Key Programming
- Caller ID Services
- Call Logs
- Date/Time
- Users & Passcodes

**Admin Tools**

- Quick Start
- User List Config
- Advanced Features
- Network Config
- Dial Plan
- Ethernet
- Protocols
- Users & Passcodes
- Media Config
- Registration
- Firmware Update
- Config Upload/Download

**Support**

## User Configuration

Use this page to configure User Details.

### User Details

\* indicates required information

\*User ID or Extension:

\*User Display name:  (max. 20 characters)

\*SIP Authentication User Name:  (eg. userId@company.com)

\*SIP Authentication Password:  (max. 20 characters)

Line Type:

BLF User Group List:

### Additional Servers

\*SIP Proxy Server:

\*Port:

Scheme:

\*SIP Registry Server:

\*Port:

Scheme:

Outbound Server:

Port:

Done Internet

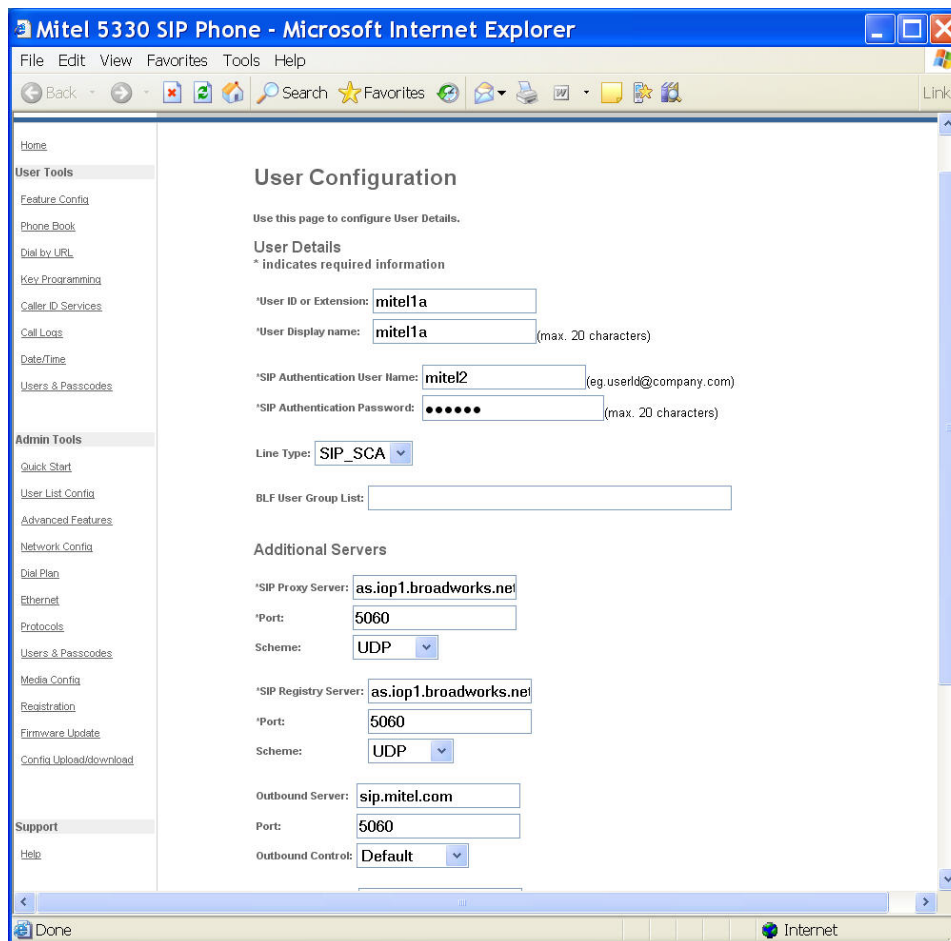



## Programming Shared Line Keys

1. Access the **Key Programming** page of the Web Configuration Tool. (Note that the 5320 IP Phone only has 8 programmable keys.)

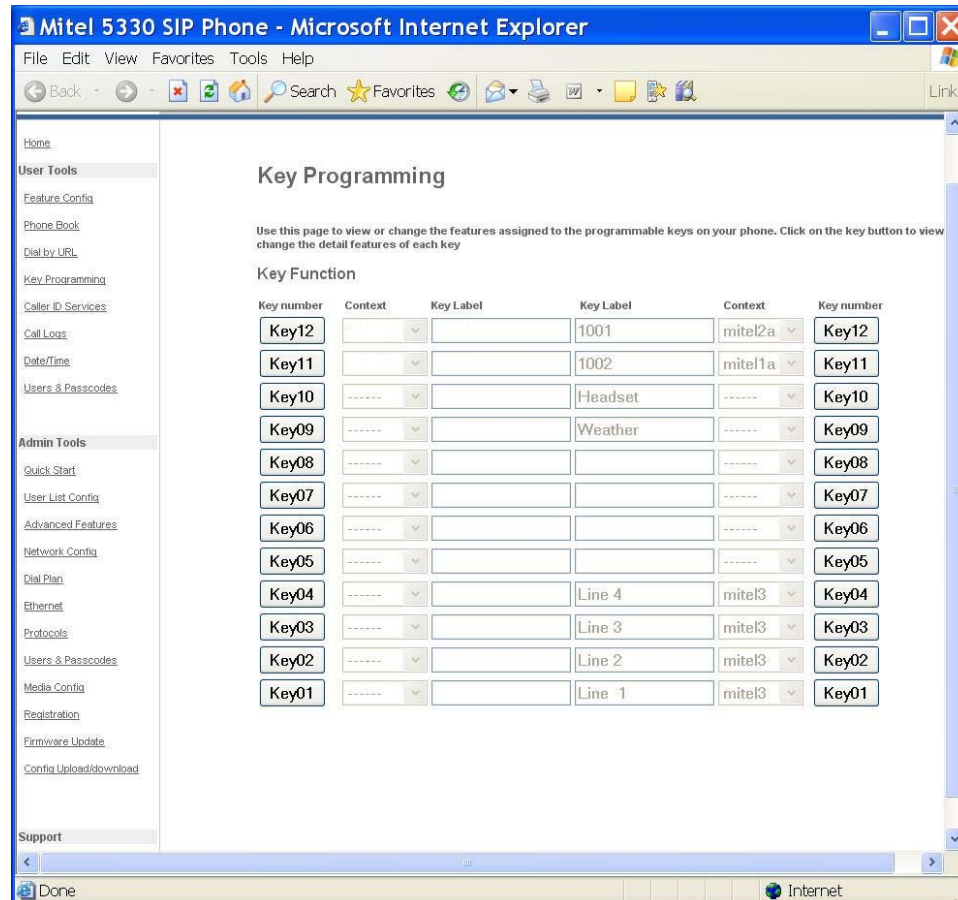

2. Click the **Key Number** of the key you want to assign as a shared line.
3. From the **Feature** list, select **Shared Line**. In the example shown below, Key 12 has been configured as a Shared Line.

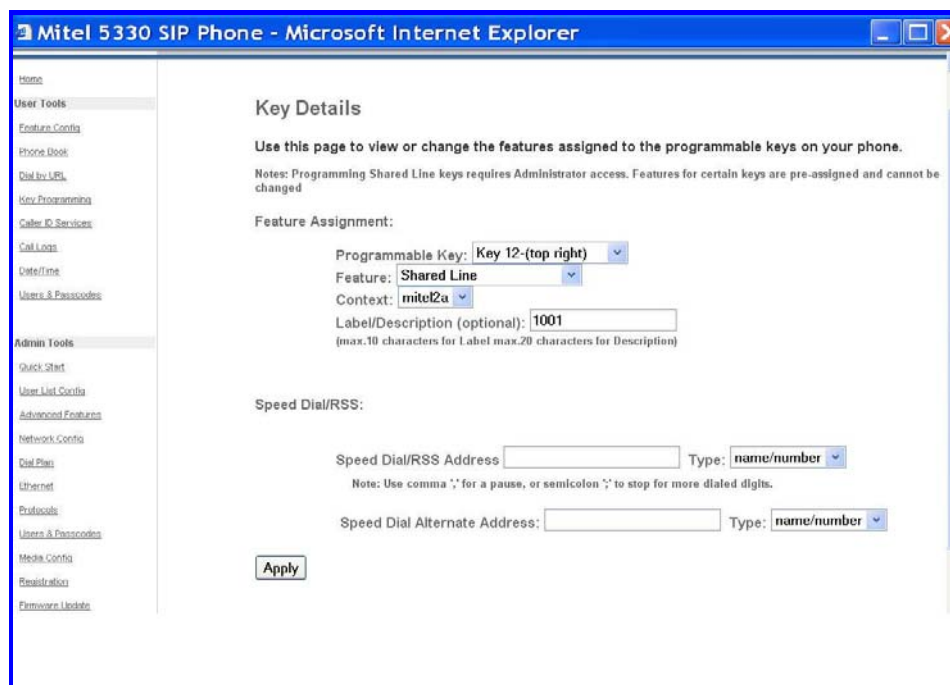

4. From the **Context** list, select the User ID with which to associate this key.
5. Enter a label/description for this key (optional).
6. Click **Apply** to apply the changes.

## Shared Line Key Status

Shared lines display the following indicator lamps:

Shared Line Status	LED Appearance	Description
Trying	Solid Red	When a user initiates a call on a shared line, the LED of that line and the LEDs of all shared lines glow red.
Active	Solid Green	When a call has been successfully connected, the LED of that line and the LEDs of all shared lines glow green.
Held	Flashing Red	When a user puts another party on hold, the LED of that line and the LEDs of all shared lines flash red.
Alerting	Flashing Green	When a call is incoming, the LED of the called line and the LEDs of all shared lines flash green.

## Programming Busy Lamp Field Keys

The Busy Lamp Field (BLF) feature allows you to program a key on your IP phone that monitors whether or not another user is on a call.

Before programming the BLF Keys, the Broadsoft server must be configured with a list of BLF users.

 **Note:** Before programming the Busy Lamp Field keys, the Broadsoft server must be configured with the blfist Group, and with the capability to provide the BLF feature to SIP phones.  
In the example that follows, the “blfist” is configured on the Broadsoft sever as a BLF list URL with two users, mitel1 and mitel2, as the monitored user IDs.

The diagram below shows an example of how Users 1 – 3 have been configured on the Broadsoft server, with User3 (on mitel3) configured to monitor User1 and User2 (from the blfist Group).

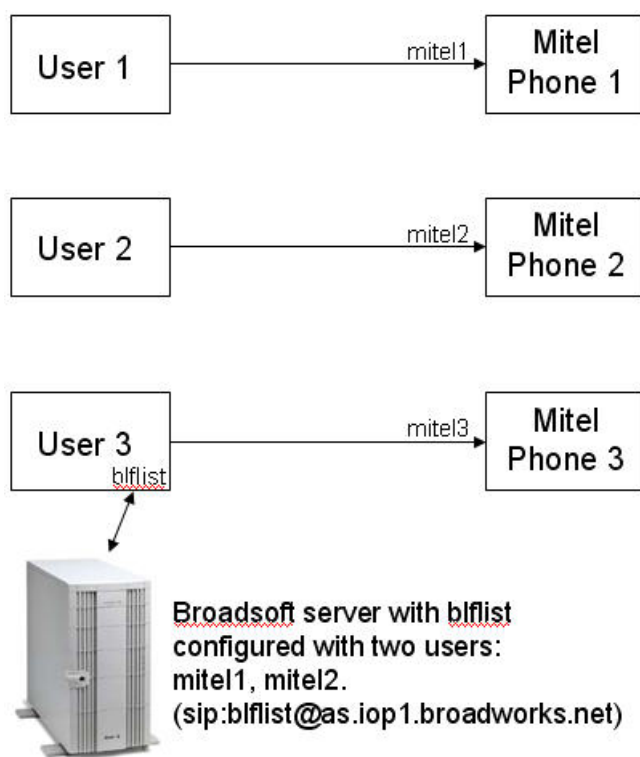

Figure 7: User Configuration for BLF

The diagram below reflects the above example, but shows how the User Configuration and Key Programming pages (in the Web Configuration tool) are completed for BLF Keys, where mitel3 has been configured to monitor mitel1 and mitel2. This example applies to the following procedures describing how to program BLF Keys.

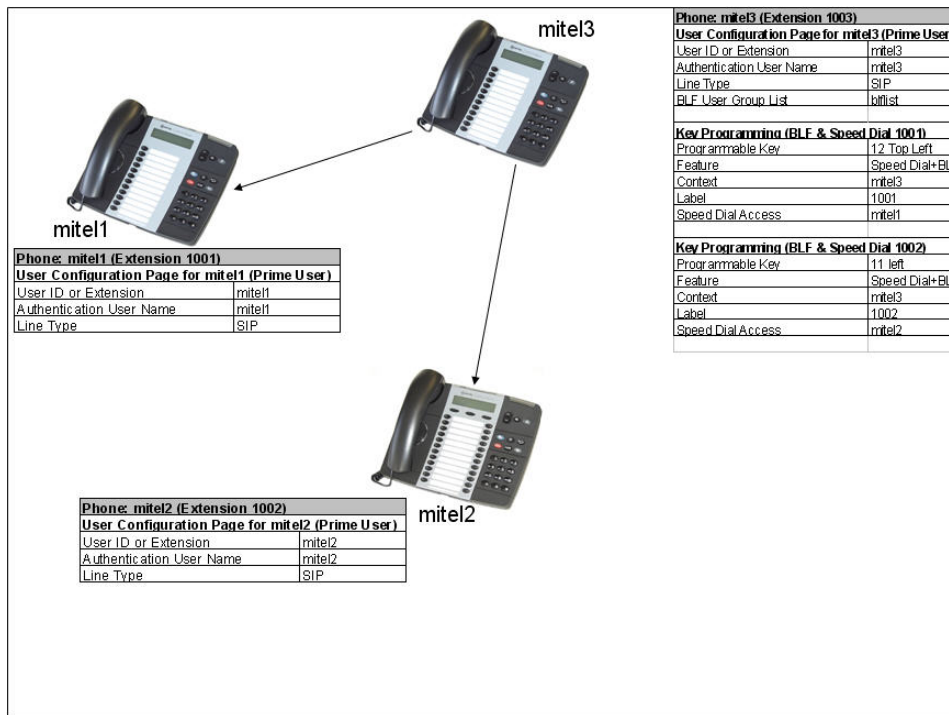
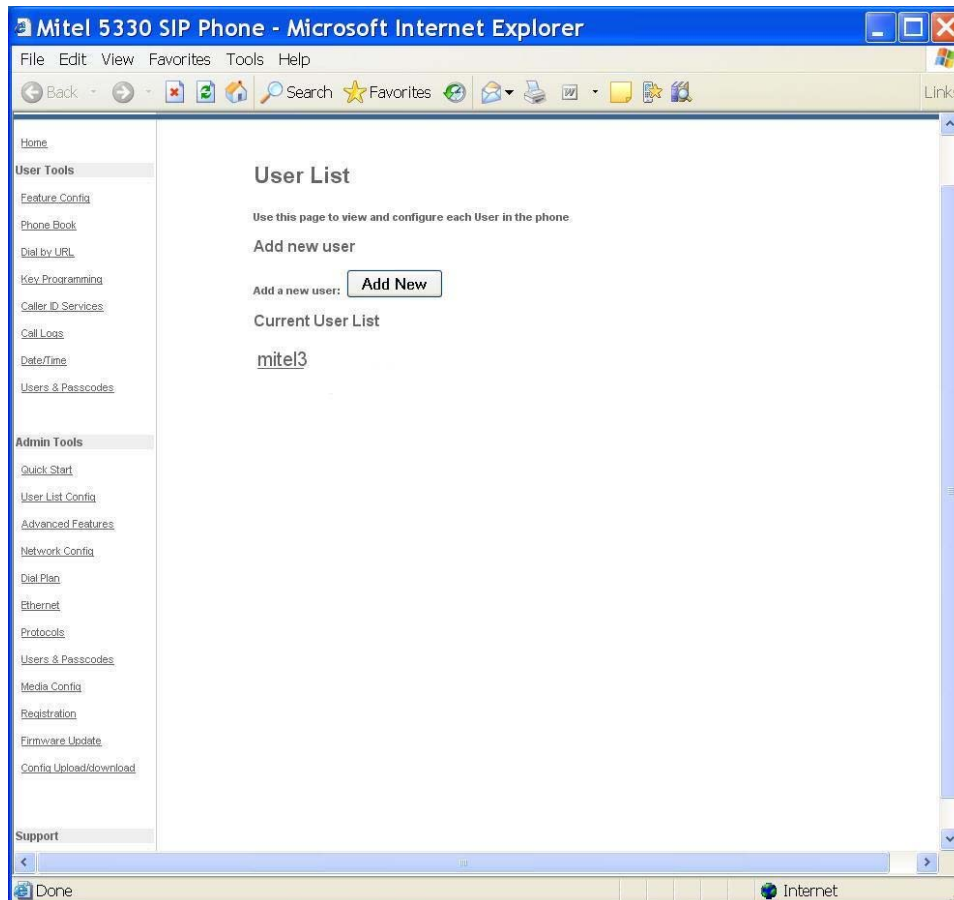
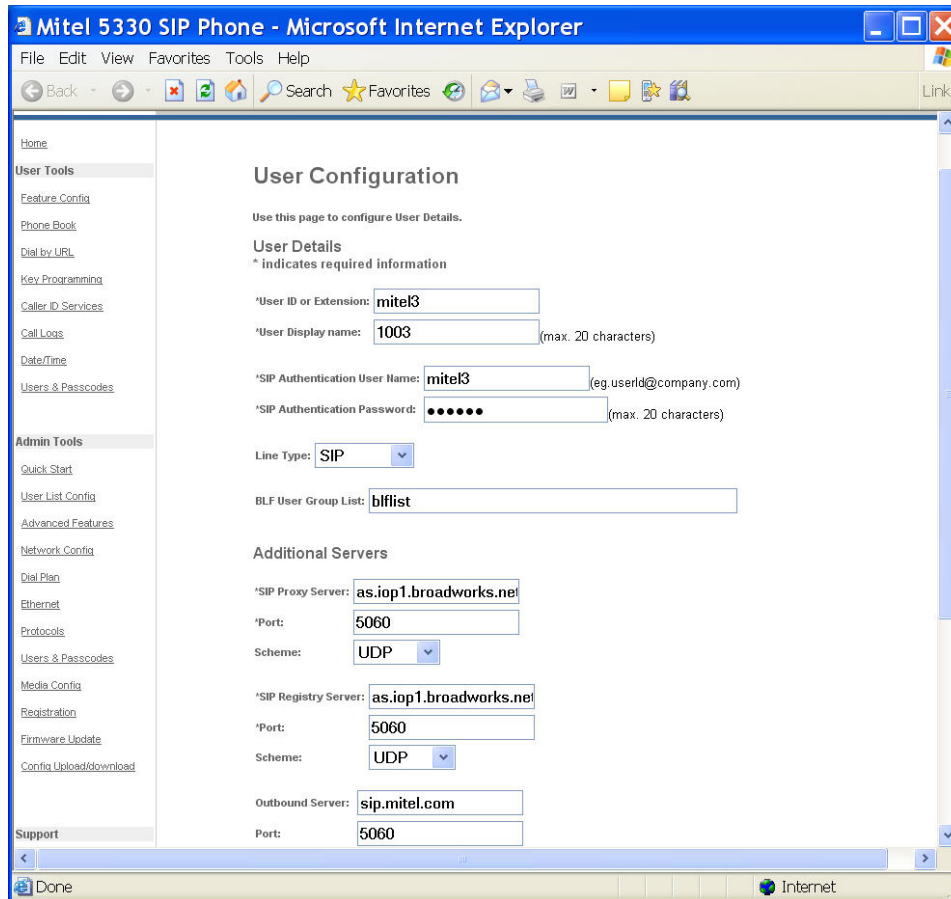

Figure 8: Programming and Configuration of Users and BLF Keys

The illustration below shows an example of the User List configuration for the single user on mitel3.



Your Administrator must configure the BLF User Group List on the User List Config page.



To program a BLF Key:

1. Access the **Key Programming** page of the Web Configuration Tool. (Note that the 5320 IP Phone only has 8 programmable keys.)

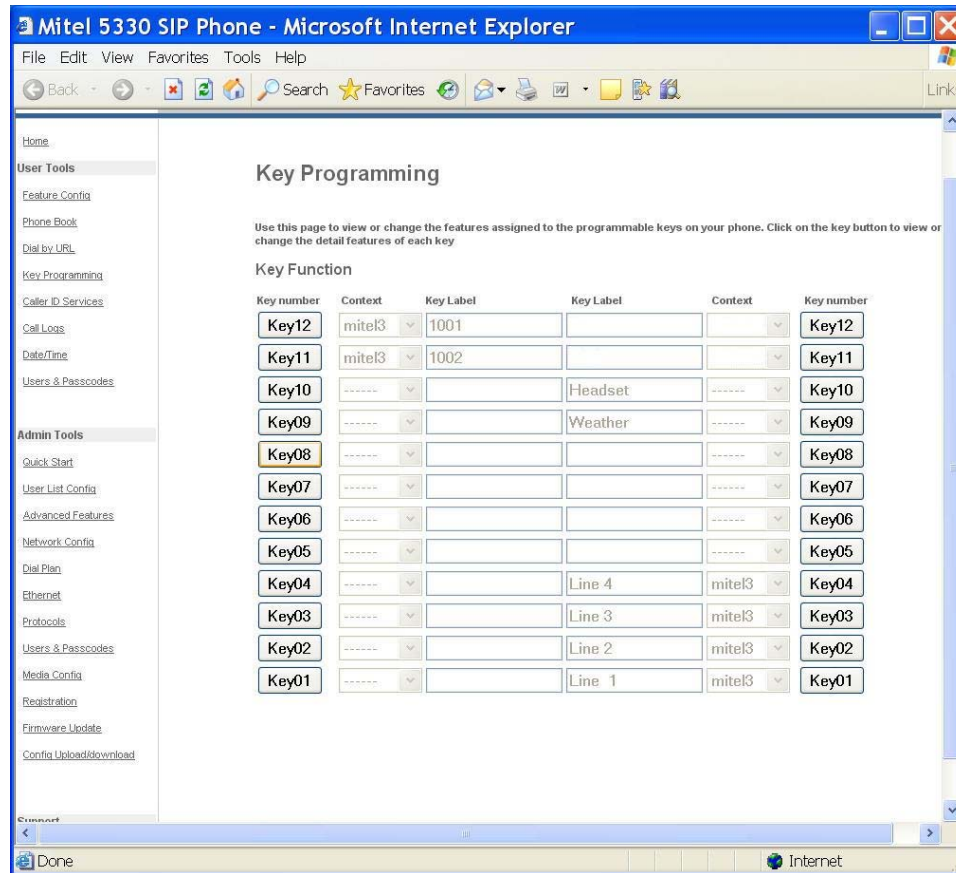

2. Click the **Key Number** of the key you want to assign as a BLF key. In this example, Key 11 - left is selected to monitor user mitel2 on extension 1002.
3. From the **Feature** list, select **Speed Dial + BLF**.

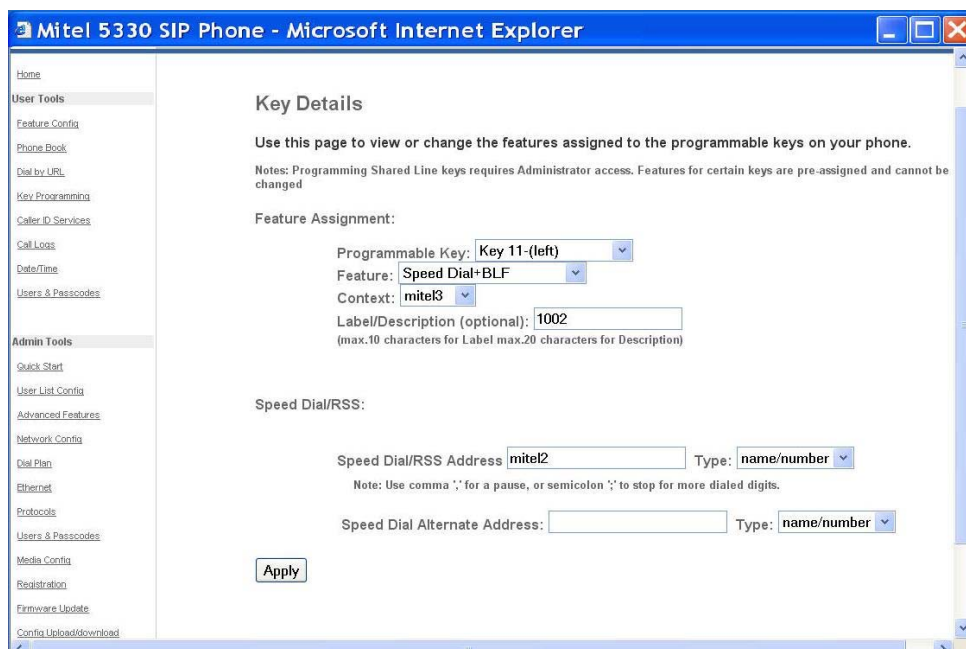

4. From the **Context** list, you can only select the PRIME USER to associate this key.
5. Enter a label/description for this key to indicate which User is being monitored (optional).
6. Enter the User ID of the monitored user in the **Speed Dial/RSS Address** field.
7. From the **Type** list, select **name/number**.
8. Click **Apply** to apply the changes.

The same procedure would be followed to configure mitel1a on Key 12-(left) as the BLF Key.

The BLF Key also acts as a Speed Dial key to the monitored user's number, and a Call Pickup key on behalf of the monitored user. The appearance of the LED indicator for the BLF key is as follows:

BLF Line Status	BLF Indicator	Description
Idle (On hook)	Off	The user being monitored is not on a call, nor dialing a call. The BLF key can be used as a speed dial key to the monitored user.
Off hook/Outgoing call	Solid Red	The monitored user is in the process of placing a call. The BLF key can be used as a speed dial key to the monitored user.
Incoming call	Flashing Green	A call is incoming for the monitored user. Press the BLF key to pick up the call on behalf of the monitored user.
Connected call	Solid Green	The incoming call has been answered by the monitored user. The BLF key can be used as a speed dial key to the monitored user.



## Time and Date

A Simple Network Time Protocol (SNTP) server (version 4 or later) provides your phone with the date and time. Your Administrator configures your time zone once using the Web Configuration Tool. If Daylight Savings Time is configured, your phone automatically adjusts to DST.

If an SNTP server is not available in your system setup, you can modify the time and date using your phone or the *Date/Time* page of the Web Configuration Tool (see Accessing the Web Configuration Tool on page 10). For more information, contact your Administrator.

### Notes:



- You cannot change your time and date settings while on a call.
- If your phone loses power, the modified time and date are not saved.

## Change the Time and Date

---

**Important: Use this procedure only if an SNTP server is not provided. If an SNTP server is not available, you must reprogram these settings every time the phone reboots.**

---

1. Press **MENU** , and then press **>>** until **Features?** appears.
2. Press **OK**, and then press **Next** until **TIME AND DATE?** appears.
3. Press **OK**. **SET TIME?** appears.
4. Do one of the following:
  - To change the time, press **YES**. **12 OR 24 HR FORMAT?** appears. Proceed to Step 5.
  - To change the date, press **NO**. **SET DATE?** appears. Proceed to step 10.
5. Do one of the following:
  - To enter the time in A.M./P.M. format, press **12**.
  - To enter the time using the 24-hour clock, press **24**.
6. **ENTER TIME** appears. Enter the time (for example, 1236 for 12:36; 0220 for 02:20), and then press **Submit**.
7. Press **AM** or **PM** (for 12-hour format only).
8. **SET TIME?** appears with the new time.
9. Press **NO**. **SET DATE?** appears.
10. Do one of the following:
  - To change the date, press **YES**, and then proceed to step 11 .
  - To exit, proceed to step 12.
11. Enter the date (for example, enter 161206 for 16 December 2006), and then press **Submit**. **SET DATE?** appears with the new date.
12. Do one of the following:
  - To return to the Features menu, press **NO**.
  - To return to the default display, press **MENU** .

## Call Forking

You can register your SIP ID with several SIP servers and have all configured aliases ring simultaneously. The indicator lamps of all configured aliases will flash until the call is answered, and then all lamps except the answering alias are extinguished. All Mitel SIP phones support call forking.

## Administrator Tools

This section is the SIP Administrator's reference to the Settings key menu interface configuration options. Where applicable, it references the appropriate page(s) of the Web Configuration Tool.

 **Note:** Some procedures can only be completed from the Web Configuration Tool.

To access the referenced pages of the Web Configuration Tool, see *Accessing the Web Configuration Tool* on page 10.

To get help with settings and programming for administrative procedures, see *Accessing the Web Configuration Tool Online Help* on page 8.

## SIP Administrator Phone Passwords

To log in for the first time as an Administrator, use the default administrator name and password. Change these passwords as soon as possible to prevent unauthorized changes to the phone.

For privacy reasons, an asterisk ( \* ) appears for each character you enter.

**Table 4: Default Administrator User Names and Passwords**

Phone	Default Administrator Name	Default Administrator Password
<b>5320 IP Phone</b>	admin	5320
<b>5330 IP Phone</b>	admin	5330
<b>5340 IP Phone</b>	admin	5340

### Change Phone Passwords

To change user or administrator passwords:

- Access the *Users & Passwords* page of the Web Configuration Tool.



## SIP User Accounts

A SIP user account includes a user name and password, and allows the user to register with the SIP Service Provider.

### Configure/Modify a SIP User account



Access the *Configuring Users and SIP Server Providers* topic in the Administrator's Web Configuration Tool online help.

### View Prime User Name

1. Press **MENU** .
2. Press the third **Personal** key (counting upwards from the bottom on the 5320/5330 IP Phone) or the **Line 3** key (counting upwards from the bottom right on the 5340 IP Phone). The user display name (top line) and user name (second line) appear in the information area.
3. Press **MENU**  to return to the default display.

## Device Parameters

To view the software version and the MAC address:

1. Press **MENU** , and then press **>>** until ADMIN TOOLS? appears on the display.
2. Press **OK**. DEVICE PARAMETERS? appears.
3. Press **OK**. SOFTWARE VERSION appears.
4. Do one of the following:
  - To view the software version, press **Review** (the current software version appears), then press **OK**. SOFTWARE VERSION reappears.
  - To view the MAC address, press **Next** (MAC ADDRESS appears), then press **Review**. The current MAC address appears. Press **OK**. MAC ADDRESS reappears.
5. Do one of the following:
  - To return to the Features menu, press **Exit**.
  - To return to the default display, press **MENU** .

 **Note:** You can also view the MAC address using the Line 1 key (see View the IP and MAC Addresses on page 46) or the Web Configuration Tool.

## Access Protocols

For information about supported communication and media protocols, access the *Configuring Protocols* topic of the Administrator's *Web Configuration Tool* (see *Accessing the Web Configuration Tool* on page 10).



## Enable/Disable Protocols

To enable/disable protocols using the Web Configuration Tool:

- Access the tool's *Protocols* page.

 **Note:** To access the Web Configuration Tool, HTTP must be enabled. If HTTP is disabled and you need to access the tool, enable HTTP through the Settings key interface as described here:



To enable/disable protocols using the **MENU** Key:

1. Press **MENU** , and then press >> until ADMIN TOOLS? appears on the display.
2. Press **OK**, and then press **Next** until ACCESS PROTOCOLS? appears on the display.
3. Press **OK**, enter your administrator password, and then press **Submit**. Protocols appear in the display one at a time, in the following order: 1. HTTP, 2.TFTP, 3.Telnet, 4.SNMP, and 5.SRTP.
4. For each protocol required, do one of the following:
  - To enable the displayed protocol, press **TurnOn**.
  - To disable the displayed protocol, press **TurnOff**.
  - Press **Next** to move to the next protocol
5. After you enable or disable a protocol, the protocol and its new status (for example, "HTTP \*ON\*") appear on the display.
6. Do one of the following:
  - To return to the Features menu, press **Exit**.
  - To return to the default display, press **MENU** .

## Network Settings

### View the IP and MAC Addresses

To view the phone's IP and MAC addresses:



1. Press **MENU** , and then press the **Line 1** key. The IP and MAC addresses appear in the information area.
2. Press **MENU**  to return to the default display.

### Modifying Network Settings

To modify network settings using the Web Configuration Tool:

- Access the *Configuring Network Settings* page of the Administrator's Web Configuration Tool.

To modify network settings using the **MENU** Key:

1. Press **MENU** , and then press **>>** until ADMIN TOOLS? appears on the display.
2. Press **OK**, and then press **Next** until NETWORK SETTINGS? appears.
3. Press **OK**, enter your administrator password, and then press **Submit**.
4. Press **Next** until the network configuration parameter you want to change appears.
5. Press **Review** to view the current settings of the selected parameter, and then do one of the following:
  - (Optional) To enable or disable the parameter, press TurnOn or TurnOff.
  - To change a value, press Change, enter the new value, and then press Submit. After the information is saved, the next setting appears.
  - To leave a value as it is, press Next to move to the next value or Exit to return to the Features menu.
6. Repeat steps 4 and 5 until all desired changes have been made.
7. Press **MENU**  to return to the default display.
8. For the settings to take effect, reboot the phone (unplug the power source from the phone, and then plug the power source back in).

## Upgrade the Phone's Firmware

To access the latest SIP firmware loads, upgrade procedures, and Release Notes:

1. In your browser, go to [www.mitel.com](http://www.mitel.com), click **Login**, and log in to Mitel OnLine.
2. Move your cursor over Products, and select SIP Desktop Devices.
3. In "Related Links" click **SIP Software Download Page** for firmware loads or **Product Documentation** to access the SIP documentation.

For detailed information about firmware upgrades:



- Access the *About Firmware Updates Page* topic in the Administrator's *Web Configuration Tool Online Help* (see page 10).

## View the Firmware Version

To view the firmware version using the Web Configuration Tool:

- Access the *Home Page* of the Web Configuration Tool.

To view the firmware version using the **MENU** Key:

1. Press **MENU**  .
2. Press the **Line 2** key. Main firmware version appears on the top line and boot firmware version appears on the second line of the information area.
3. Press **MENU**  to return to the default display.

## Upgrading the Firmware

To upgrade the firmware using the Web Configuration Tool:

- Access the *Configuring Network Settings* and *Updating Firmware* sections of the Administrator's Web Configuration Tool.

 **Note:** The phone will compare its existing firmware with the firmware on the server. If both versions are identical, the phone will not perform the upgrade procedure.

---

**CAUTION: DO NOT remove power from the phone while the phone is upgrading flash memory. This may result in severe damage to your phone.**

---

**Troubleshooting Tip:** If your phone displays "SIP MAIN NOT FOUND", it is likely that your system has experienced a power failure. The SIP Phone Boot firmware "borrows" Flash sectors from the SIP Main area during firmware installation. At the end of a normal installation, the sectors are restored without affecting SIP Main. However, if power is removed during Boot installation, then SIP Main is erased and will have to be reinstalled on the phone.

## Automating Firmware Upgrades

You can configure phones to poll the server for new versions of firmware. When the phone detects a firmware upgrade, it downloads the new version and stores it in memory. When it is next idle, the phone reboots with the new firmware.

To automate firmware upgrades, Administrators can set a Firmware Upgrade option and a polling interval on the *Firmware Update* page of the Web Configuration Tool. For programming options, refer to the online help supplied with the Web Configuration Tool.

To upgrade firmware on multiple phones, refer to the *Mass Deployment* topic in the Administrator Tools section of the Web Configuration Tool Online Help.

## SRTP Call Encryption Indicator

For information about the Call Encryption setting, see *Call Encryption Indicator* on page 7. Also refer to the *Configuring Protocols* topic in the Administrator's *Web Configuration Tool Online Help*.

## Line Types

There are three types of lines:

- **Prime lines:** a minimum of two prime lines is mandatory. (5320/5330/5340 phones support four prime lines.)
- **Non-prime lines:** optional programmed lines
- **Shared lines:** accessible by multiple telephones (See *Shared Lines and Keys* on page 29.)

## Voice Mail



Voice mail for SIP-supported phones is server-based. For more information about the voice mail system, contact your SIP Service Provider.

### Configuring Voice Mail

To configure voice mail using the Web Configuration Tool:

- Access the *Administrator Tools > Configuring SIP Features* section in the Administrator's Web Configuration Tool online help.
- Configure a **Message Waiting Indicator (MWI)** key using the Web Configuration Tool.

To configure voice mail server using the **MENU** Key:

1. Press **MENU** , and then press **>>** until ADMIN TOOLS? appears.
2. Press **OK**, and then press **Next** until NETWORK SETTINGS? appears.
3. Press **OK**, enter your administrator password, and then press **Submit**.
4. Press **Next** until VOICE MAIL SERVER appears, and then press **Review**.
5. Press **Change**, enter the IP address of the voice mail server, and then press **Submit**. After the information is saved, VOICE MAIL SERVER appears.
6. Press **Next**. VOICE MAIL PORT NUM appears.
7. Press **Review**, and then press **Change**.
8. Enter the voice mail port number, and then press **Submit**. After the information is saved, VOICE MAIL PORT NUM appears.
9. Do one of the following:
  - To return to the Features menu, press **Exit**.
  - To return to the default display, press **MENU**  .

## Adjust for Daylight Savings Time

Access the *Administrator Tools > Configuring Network Settings* topic in the Administrator's Web Configuration Tool online help.

## Additional Settings

Additional settings that you can program or modify include:

- Configuration files
- Hot Line
- Media configurations.

## Configuration Files

The 5320, 5330 and 5340 IP Phones support configuration files for automatic programming. For more information about configuration files, access the *Administrator Tools > Using the Phone Configuration File* topic in the Administrator's Web Configuration Tool online help.

## Hot Line

When a Hot Line number, SIP URL, or IP address is set up, the 5320, 5330 or 5340 IP Phone automatically dials that number or address when taken off-hook.

For Hot Line programming instructions, access the *Administrator Tools > Configuring SIP Features* section in the Administrator's Web Configuration Tool online help.

## Media Configuration

For programming instruction, access the *Administrator Tools > Configuring Media Settings* topic in the Administrator's Web Configuration Tool online help.

## Main Program and Boot Program Configuration Options

For information about additional configuration options available through the phone's main program or boot program, access the *Administrator Tools > Configuring in the Main and Boot Programs* topic in the Administrator's *Web Configuration Tool* online Help.

### Global RSS Feed

You can program a global RSS feed or branding message that will be displayed on Line 1 of Mitel SIP Phones when the phones are idle. You program the global RSS feed in the Advanced Features section of the Web Configuration Tool. For more information, refer to the Web Configuration Tool Online Help.

## Specifications

For a complete list of supported features (including Sylanro and Broadsoft features) and supported RFCs, access the *Specifications* topic in the Web Configuration Tool online help.







[www.mitel.com](http://www.mitel.com)



Global Headquarters	U.S.	EMEA	CALA	Asia Pacific
Tel: +1(613) 592-2122	Tel: +1(480) 961-9000	Tel: +44(0)1291-430000	Tel: +1(613) 592-2122	Tel: +852 2508 9780
Fax: +1(613) 592-4784	Fax: +1(480) 961-1370	Fax: +44(0)1291-430400	Fax: +1(613) 592-7825	Fax: +852 2508 9232

For more information on our worldwide office locations, visit our website at [www.mitel.com/offices](http://www.mitel.com/offices)

THIS DOCUMENT IS PROVIDED TO YOU FOR INFORMATIONAL PURPOSES ONLY. The information furnished in this document, believed by Mitel to be accurate as of the date of its publication, is subject to change without notice. Mitel assumes no responsibility for any errors or omissions in this document and shall have no obligation to you as a result of having made this document available to you or based upon the information it contains.

M MITEL (design) is a registered trademark of Mitel Networks Corporation. All other products and services are the registered trademarks of their respective holders.

© Copyright 2009 Mitel Networks Corporation. All Rights Reserved.