

**SIEMENS**





**Gigaset S685 IP / S675 IP**

**Gigaset**

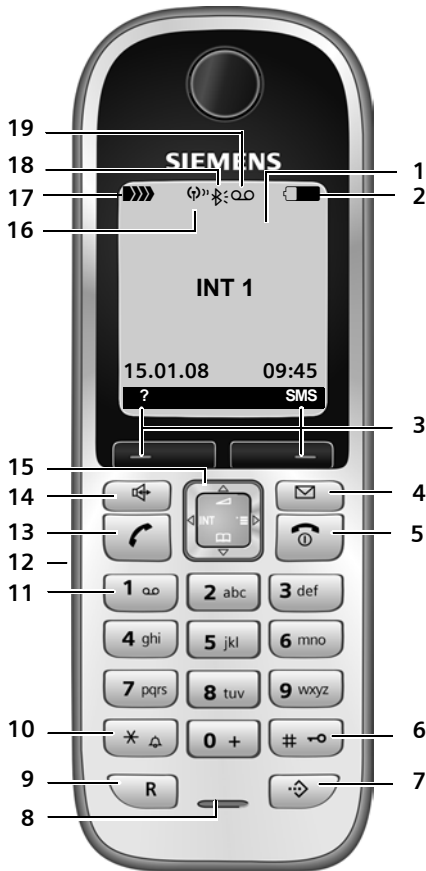

# The handset at a glance



## Handset keys

- 1 Display in idle status (example)
- 2 Charge status of the batteries  
 (1/3 charged to fully charged)  
 flashes: battery almost flat  
 flashes: battery charging
- 3 Display keys (page 32)



- 4 **Message key**  
Opens calls and message lists  
Flashes: new message or new call
- 5 **End call key, On/Off key**  
End call, cancel function, go back one menu level (press briefly), back to idle status (press and hold), activate/deactivate handset (press and hold in idle status)
- 6 **Hash key**  
Keypad lock on/off (press and hold, page 31)  
Switch between upper/lower case letters and digits for text input (page 148)
- 7 **Call-by-call list key** (not for VoIP)  
Open call-by-call list
- 8 **Microphone**
- 9 **Recall key**  
Fixed line network:  
enter flash (press briefly)  
insert a pause (press and hold)  
VoIP: enter Flash (adjustable, page 122)
- 10 **Star key**  
Idle status: ringer tones on/off (press and hold)  
Fixed line network: switch between dial pulsing/touch tone dialling  
Editor: open special characters table
- 11 **Key 1** (press and hold)  
Call the network mailbox or answer machine (Gigaset S675/S685 IP)
- 12 **Connection socket for headset** (page 19)
- 13 **Talk key**  
Accept call, open last number redial list (press briefly in idle status), select connection type and start dialling (press briefly/press and hold after entering the number, page 26)  
SMS editor: send SMS
- 14 **Handsfree key**  
Change between speaker/handsfree mode  
Lights up: handsfree talking activated  
Flashes: incoming call
- 15 **Control key** (page 32)
- 16 **Eco mode** activated (page 20)
- 17 **Signal strength**  
 (low to high)  
 flashes: no reception
- 18 **Gigaset S68H handset: Bluetooth** activated (page 94)
- 19 **Answer machine icon**  
Answer machine switched on;  
Flashes: answer machine is recording a message or is being operated by another internal party

## The base station at a glance

---

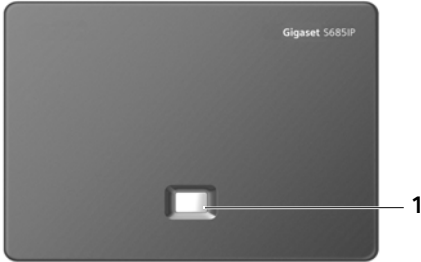

### Base station key

#### 1 Paging key

Lights up:

LAN connection active (phone is connected to router)

Flashes:

data transfer to LAN connection

Press **briefly**:

start paging (page 82), display IP address on handset

Press and **hold**:

set base station to registration mode (page 81)

### Siemens Gigaset contact numbers:

For personal advice on our range of products and for repairs or guarantee/warranty claims call:

**Service Centre UK:**   **08453 6708 12**  
(local call cost charge)

Please have your proof of purchase ready when calling.

# Contents

<b>The handset at a glance</b> . . . . .	<b>1</b>
<b>The base station at a glance</b> . . . . .	<b>2</b>
<b>Safety precautions</b> . . . . .	<b>6</b>
<b>Gigaset S685/S675 IP – more than just a telephone</b> . . . . .	<b>8</b>
<b>VoIP – making calls via the Internet</b> . . . . .	<b>9</b>
<b>Gigaset HDSP – telephony with brilliant sound quality</b> . . . . .	<b>9</b>
<b>First steps</b> . . . . .	<b>10</b>
Pack contents . . . . .	10
Setting up the handset for use . . . . .	10
Installing the base station . . . . .	12
Connecting the base station . . . . .	13
Making settings for VoIP telephony . . . . .	15
Belt clip and headset . . . . .	19
<b>ECO DECT: reducing the transmission power and power consumption</b> . . . . .	<b>20</b>
<b>Menu trees</b> . . . . .	<b>21</b>
Phone menu . . . . .	21
Web configurator menu . . . . .	25
<b>Making calls with VoIP and the fixed line network</b> . . . . .	<b>26</b>
Making an external call . . . . .	26
Ending a call . . . . .	28
Accepting a call . . . . .	28
Calling Line Identification . . . . .	29
Handsfree talking . . . . .	31
Muting the handset . . . . .	31
<b>Operating the handset</b> . . . . .	<b>31</b>
Activating/deactivating the handset . . . . .	31
Activating/deactivating the keypad lock . . . . .	31
Control key . . . . .	32
Display keys . . . . .	32
Reverting to idle status . . . . .	33
Menu guidance . . . . .	33
Correcting incorrect entries . . . . .	33
<b>VoIP telephony via Gigaset.net</b> . . . . .	<b>34</b>
Searching for subscribers in the Gigaset.net directory . . . . .	34
Entering, editing and deleting own entry . . . . .	36
Calling a Gigaset.net subscriber . . . . .	36
<b>Network services</b> . . . . .	<b>37</b>
Anonymous calling – withholding caller ID . . . . .	37
Further network services in the fixed line network . . . . .	37
Further network services for VoIP . . . . .	39
<b>Using the directory and lists</b> . . . . .	<b>41</b>
Directory/call-by-call list . . . . .	41
Using online directories . . . . .	45
Last number redial list . . . . .	48
Opening lists with the message key . . . . .	48
<b>Making cost-effective calls</b> . . . . .	<b>51</b>
<b>SMS (text messages)</b> . . . . .	<b>53</b>
Writing/sending an SMS . . . . .	54
Receiving an SMS . . . . .	55
Notification by SMS . . . . .	57
SMS mailboxes . . . . .	57
Setting SMS centres . . . . .	58
SMS on a PABX . . . . .	59
Activating/deactivating SMS function . . . . .	59
SMS troubleshooting . . . . .	60
<b>Gigaset S675/S685 IP: operating the base station answer machine</b> . . . . .	<b>61</b>
Operation via the handset . . . . .	61
Activating/deactivating call screening . . . . .	65
Setting up the answer machine . . . . .	65
Configuring the network mailbox for fast access . . . . .	66
Operating when on the move (remote operation) . . . . .	66

## Contents

### **E-mail notifications . . . . . 68**

- Opening the incoming e-mail list . . . 68
- Viewing the message header of an e-mail . . . . . 69
- Viewing an e-mail sender's address . . . . . 70

### **Messenger . . . . . 71**

- Establishing a connection, going online . . . . . 72
- Changing/checking your personal status, going offline . . . . . 73
- Opening the buddy list . . . . . 74
- Receiving messages . . . . . 75
- Writing and sending messages . . . . 76
- Calling a buddy . . . . . 77
- Self-help with errors . . . . . 77

### **Using the network mailbox . . . . 78**

- Activating/deactivating the network mailbox, entering numbers . . . . . 78
- Configuring the (network) mailbox for fast access . . . . . 79
- Listening to messages on the network mailbox . . . . . 80

### **Using several handsets . . . . . 81**

- Registering handsets . . . . . 81
- De-registering handsets . . . . . 82
- Locating a handset ("paging") . . . . 82
- Changing the base station . . . . . 82
- Changing a handset's internal number . . . . . 82
- Changing the name of a handset . . . . 83
- Making internal calls . . . . . 83
- Using a handset as a room monitor . . . . . 84

### **Handset settings . . . . . 86**

- Changing the display language . . . . 86
- Setting the display . . . . . 86
- Setting the screensaver . . . . . 86
- Setting the display backlight . . . . . 87
- Shortcuts for functions and numbers . . . . . 87
- Activating/deactivating auto answer . . . . . 88

- Changing the handsfree/earpiece volume . . . . . 88
- Changing ringer tones . . . . . 89
- Activating/deactivating advisory tones . . . . . 90
- My stuff . . . . . 90
- Setting the alarm clock . . . . . 91
- Setting an appointment (calendar) . . 92
- Displaying missed appointments and anniversaries . . . . . 93
- Gigaset S68H handset: using Bluetooth devices . . . . . 93
- Setting your own area code . . . . . 95
- Restoring the handset to the factory settings . . . . . 96

### **Base station settings . . . . . 96**

- Protecting against unauthorised access . . . . . 96
- Restoring the base station to the factory settings . . . . . 96
- Activating/deactivating music on hold . . . . . 97
- Activating/deactivating repeater mode . . . . . 98
- Set default connection . . . . . 98
- Updating the base station firmware . . 98

### **Making VoIP settings . . . . . 99**

- Using the connection assistant . . . . 99
- Changing settings without the connection assistant . . . . . 100
- Setting the phone's IP address in the LAN . . . . . 101
- Activating/deactivating display of VoIP status messages . . . . . 102
- Checking the base station MAC address . . . . . 102

### **Operating the base station on the PABX . . . . . 102**

- Changing the dialling mode . . . . . 102
- Setting recall . . . . . 102
- Setting pauses . . . . . 103
- Switching temporarily to tone dialling (DTMF) . . . . . 103

**Web configurator –configuring phone via PC . . . . . 104**

Connecting PC with Web configurator . . . . . 104

Logging in, setting the Web configurator language . . . . . 105

Logging off . . . . . 105

Structure of the Web pages . . . . . 106

Opening Web pages . . . . . 107

Setting the phone with Web configurator . . . . . 108

IP Configuration . . . . . 109

Configuring telephone connections . . . . . 110

Optimising voice quality for VoIP connections . . . . . 117

Setting the telephone default connection . . . . . 119

Assigning send and receive numbers to handsets . . . . . 120

Gigaset S675/S685 IP: assigning receive numbers to the answer machine . . . . . 121

Activating Call Forwarding for VoIP connections . . . . . 121

Setting the DTMF-reminder for VoIP . . . . . 122

Defining recall key functions for VoIP (hook flash) . . . . . 122

Defining local communication ports for VoIP . . . . . 122

Configuring call forwarding via VoIP . . . . . 123

Setting area code predialling . . . . . 123

Defining dialling plans – cost control . . . . . 124

Activating/deactivating network mailbox, entering numbers . . . . . 126

Saving messenger access data . . . . . 126

Making e-mail settings . . . . . 128

Activating/deactivating info services . . . . . 128

Selecting and registering online directories for access . . . . . 129

Changing internal handset numbers and names . . . . . 130

Loading and deleting handset directories to/from the PC . . . . . 130

Activating VoIP status message display . . . . . 132

Starting a firmware update . . . . . 132

Activating/deactivating the automatic version check . . . . . 133

Copying the date/time from time server . . . . . 134

Querying the phone status . . . . . 135

**Appendix . . . . . 136**

Care . . . . . 136

Contact with liquid . . . . . 136

Questions and answers . . . . . 136

Checking service information . . . . . 142

Service (Customer Care) . . . . . 143

Authorisation . . . . . 143

Guarantee Certificate United Kingdom . . . . . 144

Specifications . . . . . 145

Icons . . . . . 146

Example of a menu input . . . . . 146

Example of multiple line input . . . . . 147

Writing and editing text . . . . . 147

Additional functions via the PC interface . . . . . 149

Gigaset S685/S675 IP – free software . . . . . 150

**Accessories . . . . . 157**

**Glossary . . . . . 160**

**Index . . . . . 170**

**Mounting the charging cradle to the wall, connecting the charging cradle . . . . . 183**

**Mounting the base station to the wall . . . . . 184**

## Safety precautions

---

**Warning:**

Read the safety precautions and the user guide before use.  
Explain their contents and the potential hazards associated with using the telephone to your children.



Only use the mains adapter supplied, as indicated on the underside of the base station or charging cradle.



Only use the **recommended, rechargeable batteries** (page 145), i.e. never use a conventional (non-rechargeable) battery or other battery types as this could result in significant health risks and personal injury.

Batteries should not be disposed of in general household waste. Observe the local waste disposal regulations, details of which can be obtained from your local authority or the dealer you purchased the product from.



Insert rechargeable batteries with the correct polarity, and use them in accordance with this user guide (polarity symbols can be seen in or on the handset's battery compartment, page 10).



The operation of medical appliances may be affected. Be aware of the technical conditions in your particular environment, e.g. doctor's surgery.



Do not hold the rear of the handset to your ear when it is ringing or when the handsfree function is activated. Otherwise you risk serious and permanent damage to your hearing.

The handset may cause an unpleasant humming noise in hearing aids.



Do not install the base station or charging cradle in bathrooms or shower rooms. The handset, base station and charging cradle are not splashproof (page 136).



Do not use the phone in environments with a potential explosion hazard, e.g. paint shops.



If you give your Gigaset to someone else, make sure you also give them the user guide.



Please remove faulty base stations from use or have them repaired by Siemens Service, as they could interfere with other wireless services.



All electrical and electronic products should be disposed of separately from the municipal waste stream via designated collection facilities appointed by the government or the local authorities.

This crossed-out wheeled bin symbol on the product means the product is covered by the European Directive 2002/96/EC.

The correct disposal and separate collection of your old appliance will help prevent potential negative consequences for the environment and human health. It is a precondition for reuse and recycling of used electrical and electronic equipment.

For more detailed information about disposal of your old appliance, please contact your local council refuse centre or the original supplier of the product.

**Warning:**

When the keypad lock is active, you cannot call emergency numbers.

**Please note:**

Not all of the functions described in this user guide are available in all countries.



## Gigaset S685/S675 IP – more than just a telephone

---

Your phone lets you make calls both via the fixed line network and (cost effectively) via the Internet (VoIP) **without using a PC**.

Your phone can do much more besides:

- ◆ Make calls with brilliant sound quality (**High Definition Sound Performance HDSP**, page 9) – for internal calls or calls via VoIP.
- ◆ **Press a button** each time you make a call to indicate whether you want to call via the fixed line network or the Internet (page 26).
- ◆ Register up to **six** handsets on your base station. With your base station, you can simultaneously conduct two calls via VoIP and one call via the fixed line network.
- ◆ **Multiline:** Create up to six VoIP accounts with different VoIP providers. Together with your fixed line number and the Gigaset.net number, your phone can then be reached via up to **eight different phone numbers**.
- ◆ Assign each handset its own VoIP number as a send and receive number. If a member of your family is called on their VoIP number, only their handset will ring (page 120).
- ◆ You can also use the VoIP accounts with different providers for cost control purposes. When dialling, specify the VoIP connection/the VoIP account you want to use for its lower rates (page 27).
- ◆ Setting dialling plans for phone numbers or area codes enables you to automate the selection of the most cost-effective VoIP connection (page 124).
- ◆ Determine which of your phone numbers should be answered by the Gigaset S675/S685 IP answer machine (page 121).
- ◆ Use Gigaset.net for VoIP calls. Connect your phone to the mains power supply and the Internet, and enjoy free phone calls on Gigaset.net – without making any further settings (page 34).
- ◆ Configure the phone connection for VoIP without a PC. Your phone's connection assistant downloads general data about your VoIP provider from the Internet and guides you through entering your personal data (VoIP/SIP account). This makes it easy for you to start using VoIP (page 16).
- ◆ If necessary, make any further VoIP settings on a PC. The phone features a Web interface (**Web configurator**) that can be accessed via your PC's Web browser (page 104).
- ◆ Use **instant messaging** on your handset. Go online and see which of your messenger contacts (buddies) are also online. Exchange SMS messages with your buddies or simply give them a call (page 71). A free messenger account is already set up for you on the Gigaset.net Jabber server (page 127).
- ◆ Let your phone tell you, **without requiring a PC**, about new **e-mail** messages in your mailbox (page 68). Use your handset to delete old e-mail messages from your mailbox.
- ◆ Make sure your phone is always up-to-date. Keep yourself informed about **firmware updates** on the Internet and download them onto your phone (page 98).
- ◆ Reduce the transmission power of the base station and handset. Activate eco mode on your phone (page 20).
- ◆ Use your Gigaset S68H handset for wireless communication with other Bluetooth devices using Bluetooth™ (e.g. headset, PDA, page 93).

Your Gigaset S685/S675 IP has a protected operating system that offers **increased security against viruses** from the Internet.

**Enjoy using your new phone!**

## VoIP – making calls via the Internet

With VoIP (Voice over Internet Protocol), your calls are not made via a fixed connection as in the telephone network, but rather they are transmitted via the Internet in the form of data packets.

You can take advantage of all the benefits of VoIP with your phone:

- ◆ You can make cost-effective calls in high voice quality with callers on the Internet, the fixed line network or the mobile phone network.
- ◆ VoIP providers will give you personal numbers, with which you can be reached from the Internet, the fixed line network and any mobile phone network.

To be able to use VoIP, you need the following:

- ◆ A broadband Internet connection (e.g. DSL) with flat rate (recommended) or volume-based price.
- ◆ Internet access, i.e. you need a router that will connect your phone to the Internet.

You can find a list of recommended routers on the Internet at:

[www.siemens.com/gigasetcustomer-care](http://www.siemens.com/gigasetcustomer-care)

Here, go to the FAQ page and select your Gigaset IP phone. Search for "Router", for example.

- ◆ Access to the services of a VoIP provider. Open up to six accounts with **different** VoIP providers.

## Gigaset HDSP – telephony with brilliant sound quality



Your Gigaset IP phone supports the Broadband codec G.722. With your base station and the corresponding handset, you can thus make calls via VoIP with brilliant sound quality (High Definition Sound Performance).

If you register further broadband-capable handsets (e.g. Gigaset S67H, S68H or SL37H) with your base station, internal calls between these handsets will also be conducted via broadband.

Preconditions for broadband connections to your base station are:

- ◆ **For internal calls:**
  - Both handsets are broadband-capable, i.e. both support codec G.722.
- ◆ **For external calls via VoIP:**
  - You make the call from a broadband-capable handset.
  - You have selected codec G.722 for outgoing calls (page 117).
  - Your VoIP provider supports broadband connections.
  - The recipient's phone supports codec G.722 and accepts the establishment of a broadband connection.

### Please note:

The VoIP service **Gigaset.net** (page 34) supports broadband connections.

## First steps

### Pack contents

The pack contains:

- ◆ one Gigaset S685/S675 IP base station
- ◆ one Gigaset S67H/S68H handset
- ◆ one mains adapter for the base station
- ◆ one charging cradle incl. mains adapter
- ◆ one phone cable
- ◆ one Ethernet cable (LAN cable)
- ◆ two batteries
- ◆ one battery cover
- ◆ one belt clip
- ◆ one quick guide

#### Firmware updates:

Your telephone is supplied with the firmware version 097 or higher.

Whenever there are new or improved functions for your Gigaset IP phone, base station firmware updates will be made available for you to download to your telephone (page 98). If this results in operational changes to your phone, a new version of this user guide will be published on the Internet at [www.siemens.com/qigaset](http://www.siemens.com/qigaset)

### Setting up the handset for use



The display is protected by a plastic film. **Please remove the protective film!**

### Inserting the batteries

#### Warning:

Only use rechargeable batteries (page 145) recommended by Siemens Home and Office Communication Devices GmbH & Co. KG. Never use a conventional (non-rechargeable) battery or other battery types as this could result in significant health risks and personal injury. For example, the batteries could explode. The phone could also malfunction or be damaged as a result of using batteries that are not of the recommended type.

- ▶ Insert the batteries the right way round (see figure).

The polarity is indicated in/on the battery compartment.



The handset switches on automatically. You will hear a confirmation tone.

#### Closing the battery cover

- ▶ First, align the notches on the side of the battery cover with the protrusions on the inside of the housing.
- ▶ Then press the cover until it clicks into place.

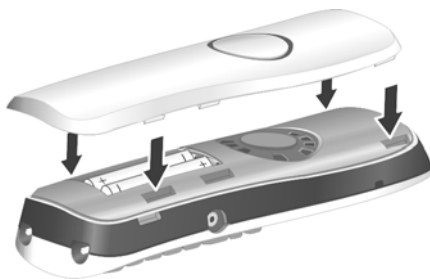

#### Opening the battery cover

- ▶ If fitted, remove the belt clip.
- ▶ Place your fingertip in the cavity on the casing and pull the battery cover upwards.

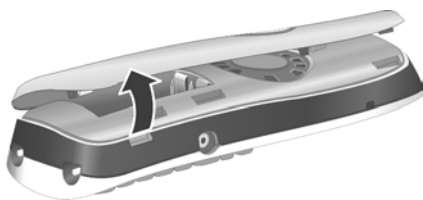

## Connecting the charging cradle

The charging cradle is designed to be operated in enclosed, dry areas at temperatures ranging from +5 °C to +45 °C.

Instructions on how to connect the charging cradle and mount it on the wall (if required) can be found on page 183.

- ▶ To charge the batteries, leave the handset in the charging cradle.

### Please note:

- Only place the handset in the charging cradle that is intended for it.
- If the handset has turned itself off because the batteries are flat and is then placed in the charging cradle, it will turn itself on automatically.

For questions and problems see page 136.

## Initial charging and discharging of batteries

If the handset is activated, the flashing battery icon  in the top right of the display indicates that the batteries are being charged.

During handset operation, the battery icon indicates the charge status of the batteries (page 1).

The correct charge status can only be displayed if the batteries are first fully charged **and** discharged through use.

- ▶ To do this, leave the handset in the charging cradle without interruption until the battery icon stops flashing in the display (around 10 hours).
- ▶ Once the batteries are fully charged, remove the handset from the charging cradle and do not put it back again until the batteries are fully discharged.

### Please note:

After the first battery charge **and** discharge, you may place your handset in the charging cradle after every call.

### Please note:

- ◆ Always repeat the charging and discharging procedure if you remove the batteries from the handset and reinsert them.
- ◆ The batteries may warm up during charging. This is not dangerous.
- ◆ After a while the charge capacity of the batteries will decrease for technical reasons.

### Please note:

You will find explanations for the symbols and typographical conventions used in this user guide in the appendix, page 146.

## Setting the date and time

The date and time must be set in order to have the correct time for incoming calls and to be able to use the alarm clock and calendar.

### Please note:



The address of a time server on the Internet is stored on your telephone. The date and time are taken from this time server provided that the base station is connected to the Internet and synchronisation with the time server is activated (page 134). Manual settings are overwritten in this case.

If the date and time on the phone have not yet been set, the **Time** display key will appear.

## First steps

### Manual setting:

You can use the menu at a later point to enter the date and time.

- ▶ Press **Time** or open the  →   
→ **Date/Time** menu.
- ▶ Change multiple line input:

#### Date:

Enter the day, month and year in 8-digit format, e.g.    

    for 07/01/2008.

#### Time:

Enter hours and minutes as 4 digits, e.g.     for 07:15 a.m.

**Save** Press the display key

The date and time are shown in the handset's idle display (page 1).

### Registering the handset to the base station

---

Your handset is registered to the base station by default.

Instructions on how to register additional handsets with the base station and make free internal calls can be found from page 81.

### Installing the base station

---

The base station is designed for use in closed, dry rooms with a temperature range of +5 °C to +45 °C.

- ▶ Place or hang the base station in a central position in your flat or house.

Instructions for mounting the base station on the wall can be found on page 184.

#### Please note:

- ◆ Never expose the telephone to heat sources, direct sunlight or other electrical appliances.
- ◆ Protect your Gigaset from moisture, dust, corrosive liquids and vapours.

## Connecting the base station

In order to be able to make calls with your phone via the fixed line network and via VoIP, you must connect the base station to the fixed line and the Internet.

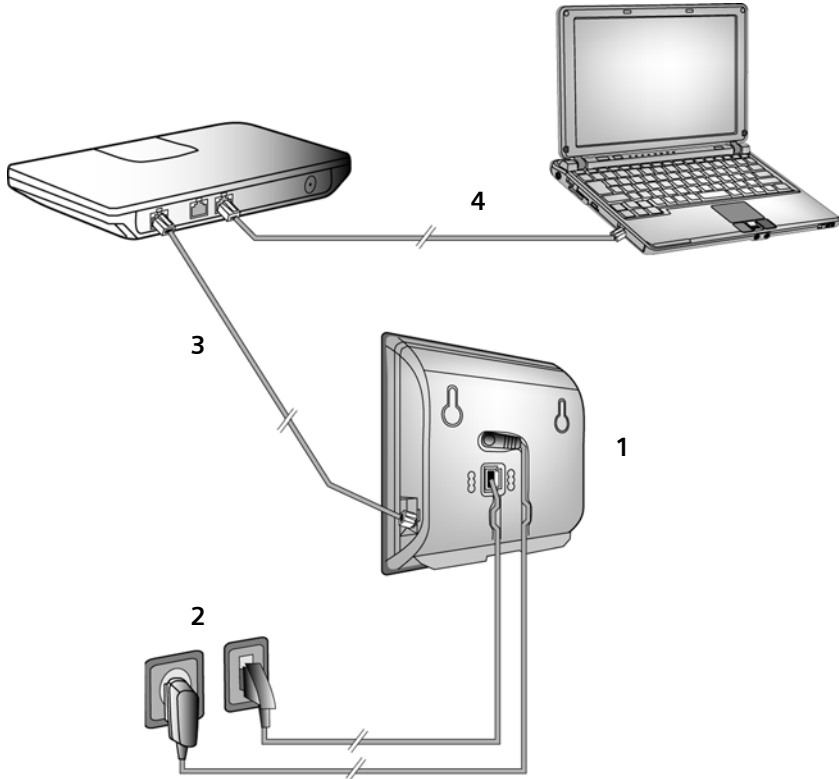

Figure 1 Connecting the phone to the fixed line and the Internet

## First steps

Follow the steps in the order given below:

1. Connect the phone cord and power lead to the base station.
2. Connect the base station to the fixed line network and the mains power supply.
3. To connect the base station to the Internet, first connect the base station to the router (connection via router and modem or via router with integrated modem).
4. Connect the PC and router (optional) - for advanced configuration of the base station (see page 104).

### 1. Connect the phone cord and power lead to the base station

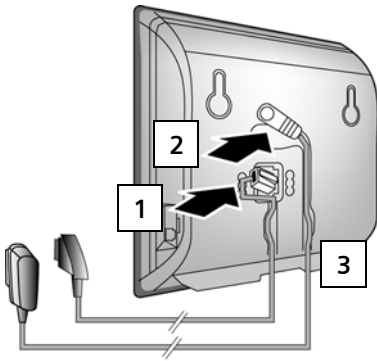

1. Insert the phone cord into the lower connection socket at the rear of the base station.
2. Insert the power lead of the mains adapter into the upper connection socket at the rear of the base station.
3. Push both cables into the appropriate cable channels.

### 2. Connect the base station to the fixed line network and the mains power supply

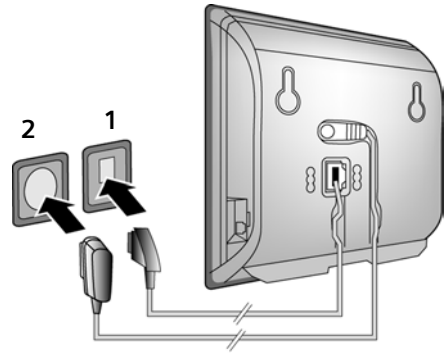

1. Insert the phone cord into the fixed line network connection socket.
2. **Then** insert the mains adapter into the mains socket.

#### Please note:

- ◆ Keep the mains adapter **plugged in at all times** for operation, as the phone does not work without mains connection.
- ◆ Only use the mains adapter and phone cord **supplied**.
- ◆ If you buy a replacement phone cord from a retailer, pay attention to the wiring of the phone jack.

#### Correct phone jack assignment

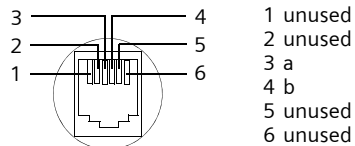

**You can now use your phone to make calls via the fixed line network and can be reached on your fixed line number.**

**Your answer machine is set with a default announcement in answer and record mode (page 61).**

### 3. Connect the base station to the router (Internet)

For Internet access you need a router connected to the Internet via a modem (this may be integrated in the router).

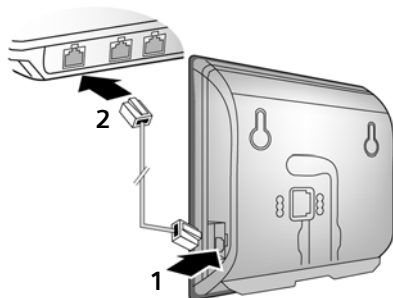

1. Connect an Ethernet cable plug into the LAN socket at the side of the base station.
2. Then insert the second Ethernet cable plug into a LAN socket on the router.

**As soon as the cable connecting the phone and router is plugged in and the router is turned on, the key lights up on the front of the base station (paging key).**

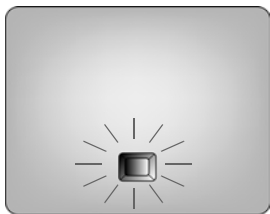

**You can now establish VoIP connections within Gigaset.net (page 34).**

## Making settings for VoIP telephony

Before you can use the Internet (VoIP) to phone any other numbers on the Internet, the fixed line network or the mobile phone network, you need the services of a VoIP provider who supports the VoIP SIP standard.

**Precondition:** You have registered with such a VoIP provider (e.g. via your PC) and set up at least one VoIP account.

The following phone settings are necessary in order for you to use VoIP. You can obtain the following information from your VoIP provider:

- ◆ Your user name with the VoIP provider, if this is required by the VoIP provider
- ◆ Your registration name
- ◆ Your password with the VoIP provider
- ◆ VoIP provider general settings

The connection assistant will help you with the settings.

#### Automatic configuration:

If your provider supports "automatic configuration", you will receive an "auto configuration code" from your provider instead of an authentication name and password.

You will need to set the VoIP configuration with the auto configuration code via the Web configurator on the base station (see page 104 "Connecting PC with Web configurator" and page 111 "Configuring the VoIP connection")





## Starting the connection assistant

**Precondition:** The base station is connected to the mains power supply and a router. Your router is connected to the Internet (page 15).

**Tip:** Leave **VoIP** activated as the default connection for your telephone (default setting, page 98). The telephone then attempts to establish a connection directly to your VoIP provider's server after the connection assistant is closed. If incorrect/incomplete information means that the connection cannot be established, messages will be displayed (page 18).

### Please note:

Your phone is preconfigured for dynamic assignment of the IP address. In order for your router to "recognise" the phone, dynamic IP address assignment must also be activated on the router, i.e. the router's DHCP server is activated. Turn to page 101 to find out how to assign your phone a static IP address if necessary.

As soon as the handset battery is sufficiently charged, the message key  on the handset will flash (approx. 20 minutes after you have put the handset in the charging cradle). Press the message key  to start the connection assistant.

You will see the following display:

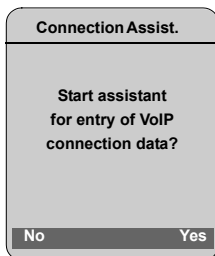

**Yes** Press the display key to start the connection assistant.

 Enter the system PIN (default is 0000) and press **OK**.

If you press **No**, the procedure that follows is described under "Entering your name in the Gigaset.net directory" on page 17.

### Please note:

The connection assistant will also start automatically if you try to establish a connection via the Internet before you have made the necessary settings.

You can also call up the connection assistant at any time via the menu (page 99).

## Downloading VoIP provider data

The phone establishes a connection with the Siemens server on the Internet. Various profiles with general access data for different VoIP providers can be downloaded here.

After a brief period you will see the following display:



Select country (press up/down on the control key) and press **OK**. VoIP providers for which VoIP profiles are available will be displayed.



Select your VoIP provider and press **OK**.

The necessary general access data for your VoIP provider will be downloaded and saved on the phone.

If the data for your VoIP provider is not available for download, press the  display key twice. You can then carry out the following steps with the connection assistant.

You must then make the required VoIP provider settings using the Web configurator (page 111). Your VoIP provider will supply you with this data.

## Entering user data for your first VoIP account

Enter the VoIP user data for the first VoIP account. Your VoIP provider will supply you with this data.

You can enter five additional VoIP accounts (VoIP phone numbers) via the Web configurator at a later stage (page 110). Your phone (together with your fixed line number) can then be reached on up to seven different phone numbers. You can assign the phone numbers to the individual handsets that are registered with the base station as send and receive numbers (page 120).

### Username:

Enter the user name and press **OK** if this is required by your provider.

### Authent. Name:

Enter the registration name and press **OK**.

### Authent. Password:

Enter password and press **OK**.

### Please note:

When making these entries, please remember the VoIP user data is case sensitive. When you enter text, the first letter is capitalised by default. If necessary, press and hold the **# →** key to switch between upper and lower case and numbers.

If you have made all the required entries, the message "**Connection data complete**" will appear on the display.

Then the Gigaset.net assistant is started.

## Entering your name in the Gigaset.net directory

With Gigaset.net you can call other Gigaset.net users directly over the Internet free of charge, without setting up an account with a VoIP provider and without making any further settings. You can find Gigaset.net subscribers by carrying out a name search in the Gigaset.net directory (page 34).

The following appears in the handset's display:

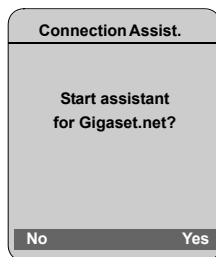

**Yes** Press the display key.

### Enter your Gigaset.net name:

Enter the name that you would like to be listed under in the Gigaset.net directory and press **OK**. The name may contain up to 25 characters.

A connection to the Gigaset.net server is established.

If there is already an entry under this name, you will receive a message to this effect and you will be asked to enter a name again.

If an entry in the Gigaset.net directory is successful, the message "**Your user name is successfully added to Gigaset.net!**" is displayed briefly.

If the attempt to create the entry fails (e.g. because the phone is not connected to the Internet), a message to this effect is displayed briefly (see page 18). You can then create the entry later via the Gigaset.net directory (see page 36).

### Completing the VoIP settings

After the entries have been completed, the handset reverts to idle status.

If all the settings are correct and if the phone can establish a connection to the VoIP server, then the internal name of the handset will be displayed (example):

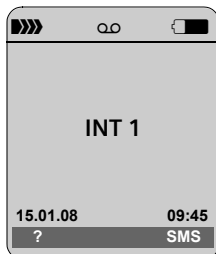

**You can now use your phone to make calls via the fixed line network and the Internet. Callers can reach you on your fixed line number and your VoIP number.**

#### Please note:

- To ensure that you can always be reached via the Internet, the router must be permanently connected to the Internet.
- If you try to make a call via a VoIP connection that is not configured correctly, the following VoIP status message will appear on the display: **IP configuration error: xxx** or **VoIP config. error: xxx** (xxx = VoIP status code). The various status codes and their respective meanings can be found in the appendix on page 140.

### No connection to the Internet/VoIP server

If one of the following messages is displayed instead of the internal name after the connection assistant is closed, errors have occurred:

- ◆ **Server not accessible!**
- ◆ **Provider registration failed!**

Below you will find possible causes and measures you can take.

#### Server not accessible!

The phone has no connection to the Internet.

- ▶ Check the cable connection between the base station and the router (the LED on the base station must light up) and the connection between the router and the Internet connection.
- ▶ Check whether the phone is connected to the LAN.
  - It may not have been possible to dynamically assign an IP address to the phone

or

- You have assigned a static IP address to the phone that has either already been assigned to another LAN subscriber or does not belong to the router's address block.
- ▶ Press the paging key on the base station. The IP address appears on the handset display.
- ▶ Press the talk key on the handset to end paging call.
- ▶ Start the Web configurator with the IP address.
- ▶ If no connection can be established, change the settings on the router (activate DHCP server) or the phone's IP address.

## Provider registration failed!

- ◆ Your personal data for registering with the VoIP provider may have been entered incompletely or incorrectly.
  - ▶ Check your entries for **Username**, **Authent. Name** and **Authent. Password**. In particular, check your use of upper and lower case. To do this, open the following menu on your handset:
    - ☐ → ☒ → **Telephony** → **VoIP** (enter system PIN) → **Provider Registr.** (see page 100)
- ◆ The server address for the VoIP server has not yet been entered, or has been entered incorrectly.
  - ▶ Start the Web configurator.
  - ▶ Open the following Web page: **Settings** → **Telephony** → **Connections**.
  - ▶ Click the **Edit** button next to the first VoIP connection.
  - ▶ Edit the server address where necessary.

### Please note:

If port forwarding is activated on your router for the ports that have been registered as the SIP port (Standard 5060) and the RTP port (Standard 5004), it is advisable to deactivate DHCP and assign the phone a static IP address (otherwise you may not be able to hear the other party during VoIP calls):

- Assign IP address via the handset menu:

☐ → ☒ → **Base** → **Local Network**

Or

- Assign IP address via the Web configurator:
  - ▶ Open the following Web page: **Settings** → **IP Configuration**.
  - ▶ Select **IP address type**.

Please note that the IP address and subnet mask depend on the router's address block.

You must also enter the standard gateway and DNS server. The IP address for the router is generally entered here.

## Belt clip and headset

By using a belt clip and headset (optional) you can easily make your handset a constant companion both inside the building and in its immediate vicinity.

### Attaching the belt clip

There are notches for attaching the belt clip on both sides of the handset at the top and at the same height as the display.

- ▶ Press the belt clip onto the back of the handset so that the protrusions on the belt clip engage with the notches.

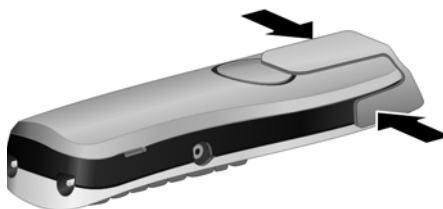

### Connection socket for headset

You can connect various headset types (with 2.5 mm jack connector), including HAMA Plantronics M40, MX100 and MX150.

A compatibility list of tested headsets is available on the Internet at:

[www.plantronics.com/productfinder](http://www.plantronics.com/productfinder)

## ECO DECT: reducing the transmission power and power consumption

---

The base station of your phone is an ECO DECT base station, this means that:

- ◆ The base station uses less power because it is equipped with a power-saving mains adaptor.
- ◆ The reduction of the handset's transmission power is dependent on the handset's proximity to the base station.
- ◆ The base station can also be switched to eco mode. Eco mode reduces the transmission power and power consumption of the base station. This can be set on your handset.

### Activating/deactivating eco mode

**Precondition:** Repeater support must be deactivated.

 →  → Base → Add. Features

**Eco Mode** Select and press **OK** ( = on).

Eco mode enables an additional reduction in the transmission power of the **Gigaset S67H/S68H** handset. If, with Eco mode activated, the transmission power of both the base station and the handset is reduced, the  icon is shown in the top line of the display.

#### **Please note:**

- Activating eco mode reduces the range of the base station.
- Eco mode and repeater support cancel each other out, i.e. both functions cannot be used at the same time.

# Menu trees

## Phone menu

Open the main menu on your phone by right-clicking the control key when the handset is in idle status: .



There are two ways to select a function:

### Using number combinations (shortcut)

- ▶ Enter the number combination that is in front of the function in the menu tree.

**Example:**     for "Set handset language".

### Scrolling through the menus

- ▶ In the main menu: navigate to the function using the control key   (press up/down or left/right) and press **OK**.
- ▶ In the submenus: scroll to the function with the control key  (press up or down) and press **OK**.

## 1 Messaging

1-1	SMS	<b>An SMS mailbox (general or private) activated without a PIN</b>			page 53	
		1-1-1	New SMS		page 54	
		1-1-2	Incoming (0)		page 55	
		1-1-3	Outgoing (0)		page 54	
		<b>An SMS mailbox activated with a PIN or 2-3 mailboxes</b>				
		1-1-1	Mailbox	1-1-1-1	New SMS	page 54
				1-1-1-2	Incoming (0)	page 55
				1-1-1-3	Outgoing (0)	page 54
		1-1-2	Mailbox 1	1-1-2-1	New SMS	page 54
		to	Mailbox 2	to		
		1-1-4	Mailbox 3	1-1-4-1		
				1-1-2-2	Incoming (0)	page 55
				to		
				1-1-4-2		
				1-1-2-3	Outgoing (0)	page 54
				to		
				1-1-4-3		

## Menu trees

		1-1-6	Settings	1-1-6-1	Service Centres	page 58
				1-1-6-2	SMS Mailboxes	page 58
				1-1-6-3	Notify Number	page 57
				1-1-6-4	Notify Type	page 57
				1-1-6-6	Subscribe to SMS	page 53
1-2	E-mail					page 68
1-3	Messenger	1-3-1	Buddies			page 74
		1-3-2	User Status	1-3-2-1	Change Status	page 73
				1-3-2-2	Info	page 73
		1-3-3	Messages			page 75

## 2 Sel. Services

2-1	VoIP	2-1-6	Call Divert			page 39
		2-1-7	Call Waiting			page 39
2-2	Fixed Line	2-2-6	Call Divert			page 37
		2-2-7	Call Waiting			page 38
2-3	Ringback Off					page 39
2-4	Always anon.					page 37
2-5	Next Call					page 37

## 3 Calls List

### 4 Add. Features

4-3	Room Monitor					page 84
4-4	Data Transfer	4-4-2	Bluetooth			page 94
		4-4-3	Directory			page 43
4-6	Missed Alarms					page 93

## 5 Alarm Clock

page 91

## 6 Calendar

page 92

7  Resource Dir.

7-1	Screensavers	page 91
7-2	Caller Pictures	page 91
7-3	Sounds	page 91
7-4	Capacity	page 91

8  Settings

8-1	Date/Time				page 11	
8-2	Audio Settings	8-2-1	Handset Volume			
		8-2-2	Ringer Settings	8-2-2-1	Ext. Calls	page 89
				8-2-2-2	Internal Calls	
				8-2-2-3	Appointments	
				8-2-2-4	All	
		8-2-3	Advisory Tones			page 90
8-3	Display	8-3-1	Screen Saver			page 86
		8-3-2	Colour Scheme			page 86
		8-3-3	Contrast			page 86
		8-3-4	Backlight			page 87
8-4	Handset	8-4-1	Language			page 86
		8-4-2	Auto Answer			page 88
		8-4-3	Register H/Set			page 81
		8-4-4	Select Base			page 82
		8-4-5	Area Codes			page 95
		8-4-6	Reset Handset			page 96
8-5	Base	8-5-1	Calls List Type	8-5-1-1	Missed Calls	page 49
				8-5-1-2	All Calls	
		8-5-2	Music on hold			page 97
		8-5-3	System PIN			page 96
		8-5-4	Base Reset			page 97
		8-5-5	Add. Features	8-5-5-1	Repeater Mode	page 98
				8-5-5-3	Eco Mode	page 20
		8-5-6	Local Network			page 101
		8-5-8	Software Update			page 98



## Menu trees

8-6	Voice Mail	8-6-1	Local AM	8-6-1-1	Ans Machine	page 61
				8-6-1-2	Call Screening	page 65
				8-6-1-3	Announcements	page 62
				8-6-1-4	Message Length	page 66
				8-6-1-5	Record Quality	page 66
				8-6-1-6	Ring Delay	page 65
		8-6-2	Network AM(s)	8-6-2-1	Net AM: Fxd. line	page 78
				8-6-2-2	Net AM: IP1	
				:	(dependent on the number of configured VoIP phone numbers and receive numbers on the handset)	
				8-6-2-7	Net AM: IP6	
		8-6-3	Set Key 1	Local AM		page 66
				Net AM: Fxd. line		page 79
				Net AM: IP1		
				:	(dependent on the number of configured VoIP phone numbers and receive numbers on the handset)	
				Net AM: IP6		
8-7	Telephony	8-7-1	Default Line	8-7-1-1	VoIP	page 98
				8-7-1-2	Fixed Line	
		8-7-2	Connection Assist.			page 99
		8-7-6	Fixed Line	8-7-6-1	Dialling Mode	page 102
				8-7-6-2	Recall	page 102
		8-7-7	VoIP	Enter system PIN.	Show Stat. on HS	page 102
					Select Provider	page 100
					Provider Registr.	page 100

## Web configurator menu

---

Home			page 104
Settings			
		IP Configuration	page 109
		Telephony	
		Connections	page 110
		Audio	page 117
		Number Assignment	page 120
		Call Forwarding	page 121
		Dialling Plans	page 124
		Network Mailbox	page 126
		Advanced Settings	page 122
		Messaging	
		Messenger	page 126
		E-Mail	page 128
		Services	page 128/page 129
		Handsets	page 130/page 130
		Miscellaneous	page 132 to page 132
Status			
		Device	page 135

## Making calls with VoIP and the fixed line network

### Making an external call

External calls are calls made via the public telephone network (fixed line network) or via the Internet (VoIP). You generally decide which connection type you want to use for a specific call when you dial the number.

#### Please note:

- You can conduct up to three separate external calls via your base station (using different handsets): two calls via VoIP and one via the fixed line network.
- You can define dialling plans for certain numbers or area codes by determining the connection and therefore the billing method to be used (cost control, see page 124) when these numbers are dialled.
- Dialling with the directory (page 41), quick dial keys (page 87) or last number redial list (page 48) saves repeated keying of phone numbers. You can modify or add to these numbers on a call-to-call basis.
- If you use VoIP to make a call to the fixed line network, you may also have to dial the area code for local calls (depending on the VoIP provider). You can avoid having to dial your own area code by entering it into the configuration (page 123). Your area code is then added automatically when you make local calls.

### Use the talk key to select the type of connection and make the call



By briefly pressing or pressing and holding the call key , you can determine the type of connection for the call you want to make (fixed line network or VoIP).

**Precondition:** You enter the number without a line suffix (page 27) and have not defined any dialling plans for this number.



Enter number (without suffix) and **briefly press/press and hold** the talk key.

A default connection is established on your phone (fixed line network or VoIP, page 98/page 119).

- ▶ **Briefly** press the talk key  if you want to make a call via this default connection.
- ▶ Press and **hold** the talk key  if you want to make the call via the other connection type.

If you have assigned a number of VoIP numbers to your phone, you can define which VoIP number (VoIP account) is used for external calls from each specific handset (handset send number, page 120).

#### Please note:

If you are using a GAP compatible handset other than the Gigaset handsets C47H, S67H, S68H, SL37H, S45 and C45, every call will be made via the standard connection, even if you press and hold the talk key. If you want to use the non-default connection to make a call, enter a star (\*) at the end of the number.

### Selecting the connection type using display keys and making a call

**Precondition:** The display keys on your handset have been assigned **FixedLine** and/or **IP** (page 87).

**FixedLine** / **IP**

Press the display key to select the connection type.



Enter the number or select from the directory.

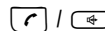

Press the talk or handsfree key.

The number will always be called via the selected connection type.

**Please note:**

If you have pressed the **IP** before dialling and ...

- ... dialled the number with suffix #1 to #6, your call will be made via the VoIP account assigned to the suffix. The number will not be dialled if the suffix is invalid (e.g. no VoIP connection assigned).
- ... dialled the number without a suffix or with the suffix #0, your call will be made via the handset's VoIP send number.

Do not enter a suffix if you have pressed the display key **FixedLine** prior to dialling. Otherwise the suffix will be dialled together with the number via the fixed line network. This may cause errors!

**Select and dial a connection via your line suffix**

You can configure up to six VoIP numbers on your phone in addition to the fixed line network number and the Gigaset.net number. A (line) suffix is assigned to each number (line) of your phone:

- ◆ the fixed line number has the suffix #0
- ◆ VoIP numbers have the suffixes #1 to #6 (page 111)
- ◆ the Gigaset.net number has the suffix #9

When dialling, you can use this line suffix to specify the connection via which you would like to call or be charged.



Enter the number of the party you wish to call.



Add the suffix for the connection (your phone number) through which you wish to make and pay for the call.



Press the talk key.

The connection is always made via the line with the assigned suffix, regardless of whether you press the call key  briefly or press and **hold**.



**Example:** If you enter the number 1234567890#1 and press the talk key , the number 1234567890 will be dialled via the first VoIP connection in the configuration.

**Please note:**

If you specify a suffix for which no VoIP connection is configured in your base station, the VoIP status code 0x33 will be displayed. The number will not be dialled.

**Entering an IP address**

You can also dial an IP address instead of a phone number using VoIP.

- ▶ Press the star key  to separate the sections of the IP address (e.g. 149\*246\*122\*28).
- ▶ If necessary press the hash  key to attach the SIP port number of the person you are calling to the IP address (e.g. 149\*246\*122\*28#5060).

You **cannot** dial IP addresses using a line suffix.

**Cancelling the dialling operation**

You can cancel the dialling operation with the end call key .

**Gigaset S68H: Continuing a call on a Bluetooth headset**

**Precondition:** Bluetooth is activated; a connection has been established between the Bluetooth headset and the handset (page 94).

Press the talk key on the Bluetooth headset; it may take up to 5 seconds to establish a connection to the handset.

For further details about your headset, see the user guide issued with it.

### Dialling emergency numbers – defining dialling plans

You can use the Web configurator to block certain numbers or to define which of your numbers (fixed line network, VoIP) should be used to call specific numbers (Dialling Plans, see page 124).

If you enter a number that has a defined dialling plan, the call will be made via the line defined in the dialling plan – regardless of whether the talk key is pressed briefly or pressed and held. Any automatic area code will **not** be prefixed to the number.

### Emergency numbers

Dialling plans for emergency numbers (e.g. the **local** emergency service number) are factory-set for certain countries. Emergency calls are then always made via the fixed line network.

You cannot delete or deactivate these dialling plans. However, you can change the connection through which each emergency number should be called (e.g. if the phone is not connected to the fixed line network). You must make sure that the VoIP provider for the selected connection supports emergency calls.

If your phone does not have default dialling plans for emergency calls, you should define the rules yourself (page 124). Assign them to a connection that you know supports emergency calls. Emergency calls are always supported by fixed line networks.

**Please note:** If no rules are defined for emergency numbers and you have programmed an automatic local area code (page 123), the code will be prefixed to emergency numbers as soon as they are dialled via a VoIP connection.

#### Please note:

Emergency numbers cannot be dialled if the keypad lock is activated. Before dialling, press **and hold** the hash key , to release the keypad lock.

### Ending a call



Press the end call key.

### Accepting a call



The handset indicates an incoming call in three ways: by ringing, by a display on the screen and by the flashing handsfree key .

#### Please note:

Only calls to receive numbers assigned to your handset will be signalled (page 120).

Calls made to a number that is not assigned to a handset as a receive number will not be signalled on any handset.

You can accept the call by:

- ▶ Pressing the talk key .
- ▶ Pressing the handsfree key .
- ▶ Pressing the display key  to forward the call to the answer machine (page 65).

If the handset is in the charging cradle and the **Auto Answer** function is activated (page 88), the handset will take a call automatically when you lift it out of the cradle.

If the ringer tone is intrusive, press the **Silence** display key. You can accept the call so long as it is displayed on the screen.

#### Please note:

You can reject VoIP calls by pressing the end call key . The caller receives an appropriate message.

Pressing the end call key on an incoming call from the fixed line network will cancel the ringer tone (same as **Silence**).

## Gigaset S68H:

### Accepting a call on a Bluetooth headset

**Precondition:** Bluetooth is activated; a connection has been established between the Bluetooth headset and the handset (see page 94).

**Only when the headset rings:** Press the talk key on the headset. It may take up to 5 seconds to establish a connection to the handset.

For further details about your headset, see the user guide issued with it.

## Calling Line Identification

When you receive a call from the Internet, the caller's number and/or the name they have specified is displayed on the screen.

When you receive a call from the fixed line network, the caller's number is displayed on the screen if the following conditions are met:

- ◆ Your fixed line network provider supports CLIP, CLI:
  - CLI (Calling Line Identification): number of the caller is transmitted
  - CLIP (Calling Line Identification Presentation): the caller's number is displayed
- ◆ You have arranged CLIP with your network provider.
- ◆ The caller has arranged CLI with the network provider.

If the phone number is identified and the caller's number is saved in your handset's local directory, the name will be displayed from the directory. A CLIP image allocated to the name will also appear in the display.

If the caller's phone number is not saved in the local directory the caller's surname and first name will be displayed from the currently active online directory.

**Precondition:** You have activated this option (see Web configurator page 129).

## Call display

You can use the display to determine whether the call is for your fixed line network number or one of your VoIP numbers.

### Calls to your fixed line number

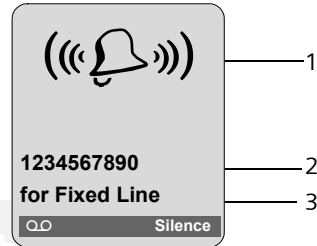

- 1 Ringer icon or the CLIP picture assigned to the caller (page 42)
- 2 Number or name of caller
- 3 Display of the receive number: The name is displayed that you have assigned to your fixed line network number (page 116).

### Calls to your VoIP number

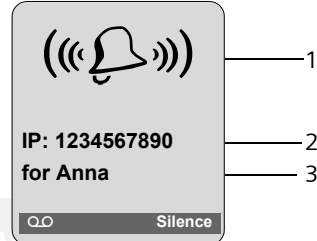

- 1 Ringer icon or the CLIP picture assigned to the caller (page 42)
- 2 Number or name of caller
- 3 Receive number: Indicates which of your VoIP phone numbers the caller has dialled. You assign the names when you enter the VoIP phone numbers into the phone (page 112). For calls from Gigaset.net, for Gigaset.net is displayed.

### Adopting the name from the online directory

You can display the name under which the caller is saved in the online directory.

#### Preconditions:

- ◆ The provider of the online directory you have set for your telephone (page 129) supports this function.
- ◆ You have activated the "display caller name" function via the Web configurator (page 129).
- ◆ The caller has authorised Calling Line Identification and has not suppressed the function.
- ◆ Your telephone is connected to the Internet.
- ◆ The caller's number is not saved in the handset's local directory.

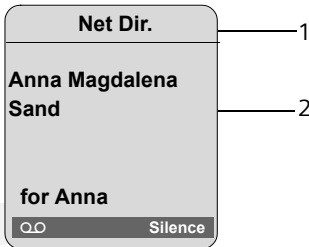

- 1 Name of the currently active online directory from which the name was obtained
- 2 Name of the caller, possibly over a number of lines  
The number is displayed if the caller's name is in neither the local directory nor the online directory.

### Display when Calling Line Identification is withheld

The caller's name and/or number will not be displayed if the caller has suppressed Calling Line Identification:

- ◆ VoIP: The caller has activated the "anonymous calling" function.
- ◆ Fixed line network: The caller has activated the "anonymous calling" function or has suppressed Calling Line Identification from the fixed line network provider.

The following is displayed in place of the number:

- ◆ For calls to one of your VoIP numbers (example):

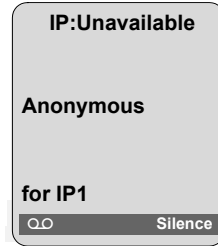

- ◆ For calls to your fixed line network numbers:
  - External, if no number is transmitted.
  - Withheld, if the caller has withheld Calling Line Identification.
  - Unavailable, if the caller has not arranged Calling Line Identification.

### VoIP: Displaying the called party's phone number (COLP)

#### Preconditions:

- ◆ Your VoIP provider supports COLP (Connected Line Identification Presentation). You may have to ask your provider to activate COLP (contact your VoIP provider for more information).
- ◆ The called party has not activated COLR (Connected Line Identification Restriction).

For outgoing VoIP calls, the phone number of the connection on which the call is received is displayed on the handset.

The displayed number may differ from the number you have dialled. Examples:

- ◆ The called party has activated call forwarding.
- ◆ The call is answered by another connection within a PABX system.

If there is an entry in the directory for this phone number, the corresponding name will be displayed.

**Please note:**

- The number of the connection you have reached (or the assigned name) will also be displayed instead of the called number during toggling, conference calls and consultation calls.
- When the phone number is copied to the directory (**Options** → **Copy to Directory**) and the last number redial list, the dialled number (not the displayed number) is copied.

## Handsfree talking

In handsfree mode, instead of holding the handset to your ear you can put it down, for example on the table in front of you. This allows others to participate in the call.

## Activating/deactivating handsfree mode

### Activating while dialling





Enter number and press **briefly**/press and **hold** the handsfree key to select the connection type (page 26).

- ▶ You should inform your caller before you use the handsfree function so that they know someone else is listening.

## Switching between earpiece and handsfree mode

- ▶ Press the handsfree key  to activate/deactivate handsfree talking during a call and when listening to the answer machine of a Gigaset S675/S685 IP.

If you wish to place the handset in the charging cradle during a call:

- ▶ Press and hold the handsfree key  while placing the handset in the charging cradle.
- ▶ If the handsfree key  does not light up, press the key again.

For how to adjust the loudspeaker volume, see page 88.

## Muting the handset

You can deactivate the microphone in your handset during an external call. Your caller will hear hold music, if activated (page 97).

### Muting the handset



Press the control key on the left to mute the handset.

### Cancelling muting



Press the display key or the end call key to cancel the muting.

## Operating the handset

## Activating/deactivating the handset



In idle status, press and **hold** the end call key.

You will hear the confirmation tone.

## Activating/deactivating the keypad lock



Press and **hold** the hash key.

You will hear the confirmation tone. The  icon appears in the display when the keypad lock is activated.

The keypad lock deactivates automatically when you receive a call and activates again after the call.

**Please note:**

The handset displays an advisory message if you press a key by accident while the keypad lock is on. To deactivate the keypad lock, press and **hold** the hash key .







## Control key







In this user guide, the side/position of the control key that you must press in the given operating situation is shown in black (top, bottom, right, left). Example:  for "press up on the control key".

The control key has a number of different functions:





### When the handset is in idle status

-  Press briefly to open the handset directory.  
Press and hold to open the list of available online directories.
-  Open the main menu.
-  Open the list of handsets.
-  Call up the menu for setting the handset's call volume (page 88), ringer tones (page 89) and advisory tones (page 90).



### In the main menu and in input fields

You can use the control key to move the cursor **up** , **down** , **right**  or **left** .

### In lists and submenus

-  /  Scroll up/down line by line.
-  Open the submenu.
-  Go back one menu level or cancel.

### During an external call

-  Briefly press to open the handset directory.  
Press and hold to open the Gigaset.net directory.
-  Initiate an internal consultation call.
-  Adjust the loudspeaker volume for earpiece and hands-free mode.

## Display keys







The current display functions are shown in the bottom display line and are reversed-highlighted. The function of the display keys changes depending on the particular operating situation.

Example:



- 1 Current display key functions are shown in the bottom display line.
- 2 Display keys

The most important display icons are:

-  Left display key, as long as it has not been assigned a function (page 87).
-  Open a situation-dependent menu (context menu).
-  Delete key: deletes one character at a time from right to left.
-  Go back one menu level or cancel operation.
-  Fetch e-mail address from the directory.
-  Copy number into directory.
-  Forward external call to answer machine.

## Reverting to idle status

---

You can revert to idle status from anywhere in the menu as follows:

- ▶ Press and **hold** the end call key .

Or:

- ▶ Do not press any key: after 2 minutes the display will **automatically** revert to idle status.

Changes that you have not confirmed or saved by pressing **OK**, **Yes**, **Save**, **Send** or **Save Entry** **OK** will be lost.

You can find an example of the display in idle status on page 1.

## Menu guidance

---

Your telephone's functions are accessed using a menu that has a number of levels.



### Main menu (first menu level)

---

- ▶ To open the main menu, press  with the handset in idle status.

The main menu functions are shown in the display as a list with colour icons.

### Accessing a function

- ▶ Navigate to the function using the control key /. The name of the function is displayed in the display header. Press the display key **OK**.

Or:

- ▶ Enter the number that is in front of the function in the menu tree (page 21) (shortcut).

The corresponding submenu (the next menu level) is opened.

## Submenus

---

The functions in the submenus are displayed as lists.

To access a function:

- ▶ Scroll to the function with the control key  and press **OK**.

Or:

- ▶ Enter the number combination that is in front of the function in the menu tree (page 21) (shortcut).

**Briefly** press the end call key  once to return to the previous menu level/cancel the operation.

## Correcting incorrect entries

---

You can correct incorrect characters in the text by navigating to the incorrect entry using the control key. You can then:

- ◆ Press **⏪** to delete the character to the left of the cursor.
- ◆ Insert a new character to the left of the cursor.
- ◆ Overwrite the flashing character when entering time and date, IP addresses etc.

**You will find examples of icons used, menu entries and multiple line input in the appendix to this user guide, page 146.**

## VoIP telephony via Gigaset.net

---

You can use **Gigaset.net** to make free phone calls via the Internet **directly** to other Gigaset.net users, without having to set up an account with a VoIP provider or make any further settings. You simply have to connect your phone to the power supply and the Internet connection and, if necessary, enter yourself in the Gigaset.net online directory under a name of your choice (page 17/page 36).

**Gigaset net** is a VoIP service provided by Siemens Home and Office Communication Devices GmbH und Co KG, which is available to all users with a Gigaset VoIP device.

You can call other subscribers to Gigaset.net **free of charge**, i.e. there are no telephone charges other than the costs for your Internet connection. Connections to/from other networks are not possible.

### Please note:

Gigaset.net supports broadband telephony: Gigaset.net calls that you make from your Gigaset S685/S675 IP (base station and handset) with a different broadband-capable terminal have excellent sound quality.

Every Gigaset VoIP device is assigned a Gigaset.net phone number by default (page 142).

All registered subscribers are included in the Gigaset.net directory, which you are able to access.

You can use an echo service provided by the telephone number **12341#9** on the Gigaset.net Web page to test your VoIP connection

After an announcement, the echo service sends back the voice data you have sent immediately in the form of an echo.

### Exclusion of liability

Gigaset.net is a voluntary service provided by Siemens Home and Office Communication GmbH & Co KG with no liability or guarantee for the availability of the network. This service can be terminated at any time with a notice period of three months.

### Please note:

If you do not use your Gigaset.net connection for six weeks, it is automatically deactivated. You cannot be reached for calls from the Gigaset.net.

The connection is re-activated:

- as soon as you start a search in the Gigaset.net directory or
- make a call via Gigaset.net (dial a number with #9 at the end) or
- activate the connection via the Web configurator (page 116).

## Searching for subscribers in the Gigaset.net directory

---

Your handset is in idle status.



Press and **hold**.



If necessary, select **Gigaset.net** from the list of available online directories and press **OK**.

Or:

- ▶ Open the directory with the button.
- ▶ Select the directory entry **Gigaset.net** and press the talk key . A connection to the Gigaset.net directory is established.

### Please note:

- The **Gigaset.net** directory entry is transferred to a handset when it is registered with the base station. Provided the handset can send and receive directory entries.
- Calls to the Gigaset.net directory are always **free of charge**.
- You can also open the Gigaset.net directory by dialling **1188#9** (phone number of the Gigaset.net directory) and pressing the talk key .

If no connection can be made to the Gigaset.net directory, an error message will be sent and the handset will go into idle status.

Once the connection has been established, you will be asked to enter a name that you want to search for.

#### Nickname search:

Enter the name or part of a name (max. 25 characters).

**Options** Press the display key.

**Start search** Select and press **OK**.

If the search has been successful, a hit list will be displayed of all the names that begin with the specified character string.

Example:

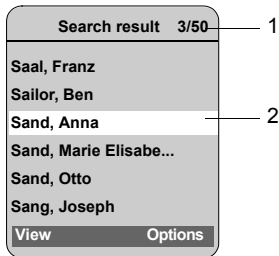

1. 3/50: Entry number/number of hits
2. Name of an entry, possibly abbreviated

You can scroll through the hit list with .

If it has **not** been possible to find a **matching** entry, a corresponding message is displayed. You have the following options:

- ▶ Press the display key **New** to start a new search.

Or

- ▶ Press the display key **Change** to change the search criteria. The previously entered name is copied and can be edited.

If there are **too many matching** entries in the Gigaset.net directory, the message **Too many entries found!** is displayed instead of a hit list.

- ▶ Press the display key **Refine** to start a refined search. The previously entered name is copied and can be edited/expanded.

### Calling subscribers

- Select the subscriber from the hit list and press the talk key.

### Viewing the subscriber's number

- Select the subscriber from the hit list.

**View** Press the display key.

The display shows the Gigaset.net number and the subscriber's name, whereby the name may appear over a number of lines.

#### Please note:

- Connections to Gigaset.net are always established via the Internet irrespective of which default connection is set on your phone. Pressing and holding or pressing it briefly and a "\*" at the end of the number have no effect.
- You can open the Gigaset.net directory and establish connections, even if you have not entered yourself in the Gigaset.net directory.

### Using other functions

**Precondition:** The hit list is displayed.

(select entry) → **Options**

The following functions can be selected with :

#### Add to directory

Copy the number to the handset directory. The number and name (where appropriate abbreviated, max. 16 characters) are copied to the directory.

- ▶ Edit and save entry where appropriate (page 41).

The hit list is displayed again.

### New search

Start a search with a new name (page 35).

### Own details

See "Entering, editing and deleting own entry" on page 36.

#### **Please note:**

If you select a Gigaset.net number from the local directory, the connection is automatically established via the Gigaset.net (Internet).

## Entering, editing and deleting own entry

You have the following options:

- ◆ Edit the name of your entry in the Gigaset.net directory
- ◆ Delete your entry from the Gigaset.net directory
- ◆ If you did not enter a name when using the phone for the first time (page 17), specify a name and enter yourself in the directory.

### Viewing own entry

You are connected to the Gigaset.net directory:

- ▶ Select **Options** → **Own details** and press **OK**.

Your Gigaset.net number and, where applicable, your currently entered name are displayed.

### Entering/editing a name

**Edit**

Press the display key.



Edit name or enter new name (max. 25 characters) and press

**OK**.

You can delete the name with

**<C**.

If there is no existing entry with this name in the Gigaset.net directory, the name is saved. A message to this effect is displayed. The handset switches to idle status.

If there is an existing entry with this name, or the entered name contains impermissible characters, you will be requested to enter a different name.

#### **Please note:**

If you delete the name, your entry will be deleted from the directory. You are no longer "visible" to other Gigaset.net subscribers. However, you can still be reached via your Gigaset.net number. For information on how to display the number, see page 142.

## Calling a Gigaset.net subscriber

You can call a Gigaset.net subscriber directly via the Gigaset.net directory (see above) or via their Gigaset.net number:



Enter the Gigaset.net number (including the #9) or select from the handset directory.



Press the talk key.

Every number ending with #9 is dialled via Gigaset.net.

## Network services

---

Network services are functions made available by your fixed line network or VoIP provider.

### Anonymous calling – withholding caller ID

---

Phone number identification can be withheld (CLIR = Calling Line Identification Restriction). Your number will not be displayed when making outgoing calls. You are calling anonymously.

#### Preconditions:

- ◆ For anonymous calls via your fixed line network connection you need to have requested the relevant service (feature) from your fixed line network provider.
- ◆ Anonymous calls are only possible via VoIP connections through providers that support the "anonymous calling" function. You may have to ask your VoIP provider to activate this function.

### Activating/deactivating anonymous calling for all calls

---

Withholding caller ID can be activated/deactivated permanently for all your phone's connections (fixed line network and VoIP).

When this function is activated, the phone number will be withheld both for fixed line network calls and for calls via a VoIP connection. Withholding caller ID is activated for all registered handsets.

 →  Sel. Services

Always anon.

Select and press **OK** ( = on).

If the **Always anon.** function is activated, **Withhold number active** is shown in the handset's idle display.

### Activating/deactivating "anonymous calling" for the next call

---

You can change the setting for withholding caller ID for the next call.

 →  Sel. Services → Next Call

Anonymous:

Select **Yes / No** to activate/deactivate withholding caller ID and press **Dial**.



If necessary, enter the phone number with line suffix.

**Send**

Press the display key. The phone number is dialled. If you have not specified a line suffix, the number will be dialled via the default connection.

### Further network services in the fixed line network

---

The following network services can only be used for making calls via the fixed line network. You will need to request them from your fixed line network provider.

- ▶ **If you require assistance, please contact your network provider.**

### Settings for all calls

---

If you have completed one of the following procedures, a code is sent.

- ▶ After confirmation from the telephone network, press the end call key .

You can set the following features:

#### General call forwarding

 →  → Fixed Line → Call Divert

- ▶ Change multiple line input:

When:

Select **All Calls / No Answer / When Busy**.

**All Calls:** Calls are forwarded immediately, i.e. no more calls to your fixed line number are signalled on your phone.

## Network services

**No Answer:** Calls are forwarded if no-one replies within several rings.

**When Busy:** Calls are forwarded if your line is busy.

### Call No.:

Press the display key **Edit**. Enter number to which call is to be forwarded and press **Save**. You can enter a fixed line, VoIP or mobile number.

### Status:

Activate/deactivate call forwarding.

- ▶ Press the display key **Send**.
- ▶ Press the end call key  after the announcement from the telephone network.

## Activating/deactivating call waiting

If call waiting is activated, a caller on the fixed line network will hear the ringing tone if you are already conducting a phone conversation using your fixed line connection. This call is announced acoustically and visually on your handset screen.

Calls on the VoIP connection are not shown as call waiting. They are signalled on other registered handsets. If no other handset is available, the caller will hear the busy tone.

Accepting/rejecting a waiting call, see page 38.

 →  → **Fixed Line** → **Call Waiting**

**Status:** Activate/deactivate.

- ▶ Press the display key **Send**.
- ▶ Press the end call key  after the announcement from the telephone network.

### Please note:

The setting does not affect the procedure for call waiting on the VoIP connection. For how to activate/deactivate call waiting for the VoIP connection, see page 39.

## Functions during a call

### Initiating ringback

You hear the busy tone.

**Options** → **Ringback**



Press the end call key.

### Consultation call

During a call:

**Ext.Call** Press the display key.



Enter a number or copy it from the directory and press **OK**.



The number will be dialled via the fixed line connection.

### Please note:

After a few seconds, the number selected for a consultation call is saved in the last number redial list.

You have the following options:

#### ◆ Toggling:

- ▶ Use  to toggle between the participants.
- End call with active participant: **Options** **End Active Call**.
- End call with both participants: press the end call key .

## Accepting a waiting call

**Precondition:** Call waiting is activated (page 38).

**Accept** Press the display key.

Or: if the caller's number is not transferred:

**Options** → **Accept waiting call**

You have the option of toggling or holding a conference call.



### Please note:

- Without CLIP, a waiting call is only announced with a signal tone.
- If the first call was an internal call, the internal connection is ended.
- An internal call waiting is shown on the display. You can neither accept the internal call nor reject it.

## Functions after a call

---

### Cancelling ringback

 →  → Ringback Off

If you have cancelled the ringback, a code is sent.

- ▶ After confirmation from the telephone network, press the end call key .

## Further network services for VoIP

---

You can use the following network services to make calls via the VoIP connection.

### Settings for all calls

---

#### General call forwarding

**Precondition:** The VoIP provider supports call forwarding.

 →  → VoIP → Call Divert

The display shows a list of configured and activated VoIP phone numbers and the Gigaset.net number of your telephone. Numbers for which call forwarding is activated are marked with .

- ▶ Select the phone number for which you want to activate or deactivate call forwarding, and press **OK**.
- ▶ Change multiple line input:

#### When:

Select **All Calls / No Answer / When Busy**.

**All Calls:** Calls are forwarded immediately, i.e. no more calls are signalled on your phone for this VoIP phone number.

**No Answer:** Calls are forwarded if no one replies within several rings.

**When Busy:** Calls are forwarded if your line is busy.

#### Call No.:

Press the display key **Edit**. Enter number to which call is to be forwarded and press **Save**.

You can state a fixed line network, VoIP or mobile number for forwarding calls from a VoIP number.

You must state another Gigaset.net number for call forwarding from your Gigaset.net number.

#### Status:

Activate/deactivate call forwarding.

- ▶ Press the display key **Save**.

**Please note** that call forwarding from your VoIP number may incur additional costs. Please consult your VoIP provider.

### Activating/deactivating call waiting

**Precondition:** Your phone will permit two parallel VoIP connections (s. **Allow 1 VoIP call only** on page 117).

If call waiting is activated, a caller on one of your VoIP connections will hear the ringing tone if you are already on a call using this VoIP connection. This call is announced acoustically and visually on your handset screen.

Calls on the fixed line connection are not signalled as call waiting. They are signalled on other registered handsets to which the fixed line number has been allocated as a receive number. If no other handset is available, the caller will hear the busy tone.

Accepting/rejecting a waiting call, see page 40.

 →  → VoIP → Call Waiting

**Status:** Activate/deactivate.

- ▶ Press the display key **Save**.

#### **Please note:**

The setting applies to all VoIP phone numbers. It does not affect the procedure for call waiting on the fixed line connection. For how to activate/deactivate call waiting for the fixed line connection, see page 38.



## Functions during a call

**Precondition:** Your phone will permit two parallel VoIP connections (see **Allow 1 VoIP call only** on page 117).

### Consultation call

During a call:

**Ext.Call** Press the display key.





Enter the number or copy from the directory and **briefly press/press and hold** the talk key .

The number must be dialed via VoIP.

#### **Please note:**

After a few seconds, the number selected for a consultation call is saved in the last number redial list.

If the participant answers, you have the following options:

- ◆ **Toggleing:**
  - ▶ Use  to toggle between the participants.
  - ▶ End call with active participant:  
**Options** **End Active Call**.
- ◆ **Conference call:**
  - ▶ Call both participants: press the display key **Conf.**
  - ▶ End the conference call (toggleing): press display key **EndConf**.
  - ▶ End call with both participants: press the end call key .
- ◆ **Forwarding (provider dependent):**

**Precondition:** You are toggleing calls and you phoned the currently active participant yourself.

  - ▶ To connect the two external participants:  
**Options** **Call Transfer**

If call forwarding was successful, a message will appear to this effect. The handset will then switch to idle.

## Accepting a waiting call

**Precondition:** Call waiting is activated (page 39).

**Accept** Press the display key.

You have the option of toggling or holding a conference call.

#### **Please note:**

- If the first call was an internal call, the internal connection is ended.
- An internal call waiting is shown on the display. You can neither accept the internal call nor reject it.

## Using the directory and lists

The options are:

- ◆ Directory
- ◆ Call-by-call list
- ◆ If applicable, online directories
- ◆ Last number redial list
- ◆ E-mail, SMS and messenger list
- ◆ Calls list
- ◆ Answer machine list

You can store a maximum of 250 entries in the directory and call-by-call list (the actual number depends on the size of the individual entries).

You create the directory and call-by-call list for your own individual handset. However, you can send the lists or individual entries to other handsets (page 43).

### Directory/call-by-call list

#### Please note:

For quick access to a number from the directory or the call-by-call list (quick dial), you can assign the number to a key (page 43).

### Directory

In the **directory**, you can save

- ◆ Up to three numbers and associated first names and surnames
  - ◆ VIP designation and VIP ringer tone (optional)
  - ◆ E-mail address (optional)
  - ◆ CLIP pictures (optional)
  - ◆ Anniversaries with reminder
- ▶ With the handset in idle status, open the directory by pressing the  key.

### Length of the entries (directory)

3 numbers:

each max. 32 digits

First name and surname:

each max. 16 characters

E-mail address

max. 60 characters

#### Please note:

Some VoIP providers do not support local calls for calls to the fixed line network. In this case, always enter the fixed line number with the area code in your directory. Alternatively, you can also use the Web configurator to define an area code, which is automatically prefixed to all numbers that are dialled via VoIP without an area code (page 123).

### Call-by-call list

The **call-by-call list** is used to store access codes for network providers (called "call-by-call numbers"), that can be put ahead of the numbers when dialling via the fixed line network.

- ▶ Open the call-by-call list in idle status by pressing the  key.

### Length of entries

Number: max. 32 digits

Name: max. 16 characters

### Storing a number in the directory

 → New Entry

- ▶ Change multiple line input:

#### First Name / Surname:

Enter a name in at least one of the fields.

#### Phone (Home) / Phone (Office) / Phone (Mobile)

Enter a number in at least one of the fields.

#### E-mail

Enter e-mail address.

## Using the directory and lists

### Annivers.:

Select **On** or **Off**.

With setting **On**:

Enter **Anniversary (Date)** and **Annivers. (Time)** (page 45) and select reminder type: **Annivers. (Signal)**.

### Caller Picture

Precondition: Calling Line Identification (CLIP).

If required, select a picture to be displayed when the caller calls.

The options are:

- CLIP pictures that are supplied with the handset.
- Additionally for the Gigaset S68H, your own pictures that have been loaded onto the handset from your PC (page 149).

The pictures are saved in the My Stuff section of the handset (page 90).

- ▶ Save changes (page 147).

### Please note:

- To find out how to enter IP addresses, turn to page 27.
- If you want to dial a certain number using the same line connection each time, you can add the relevant line suffix to the number in question (page 27).
- If you add a star (\*) at the end of the number, the number will be dialled via the non-standard connection (page 98), even if you briefly press the talk key . On condition that no dialling plan has been defined for the number (page 124).
- You can use the Web configurator to save the directory to a file on your PC, where it can be edited and then sent back to the handset (page 130). Or you can transfer Outlook contacts from the PC to the handset's directory.

## Storing a number in the call-by-call list

 → **New Entry**

- ▶ Change multiple line input:



**Number:**

Enter the number.



**Name:**

Enter name.

## Selecting entries in the directory and call-by-call list

 /  Open the directory or call-by-call list.

You have the following options:

- ◆ Use  to scroll to the entry until the required name is selected.
- ◆ Enter the first character of the name (in the directory: first character of the surname or of the first name if **only** the first name has been entered), or scroll to the entry using .

## Dialling with the directory/call-by-call list

 /  →  (Select entry; page 42)

 Briefly press/press and hold the talk key. The number is dialled using the selected connection type (page 26).

### Please note:

You can only dial IP addresses via VoIP.

## Managing directory/call-by-call list entries

 /  →  (Select entry; page 42)

### Viewing entries

**View**

Press the display key. The entry is displayed.  
Back with **OK**.

### Editing entries

**View**

**Edit** Press the display keys one after the other.

- ▶ Carry out changes and save.

## Using other functions

 /  →  (Select entry; page 42)

**Options** Open menu.

The following functions can be selected with :

### Display Number

Change or add to a saved number and then dial it (press talk key ).

### Edit Entry

Edit selected entry.

### Delete Entry

Delete selected entry.

### VIP Entry (directory only)

Mark a directory entry as **VIP** (Very Important Person) and assign it a particular ringer tone. You can then identify VIP calls by their ringer tone melody.

**Precondition:** Calling Line Identification (page 29).

### Copy Entry

Send a single entry to a handset (page 43).

### Delete List

Delete **all** entries in the directory or in the call-by-call list.

### Copy List

Send complete list to a handset (page 43).

### Available Memory

Display the available entries in the directory and call-by-call list.

## Using quick dial keys

How to assign numbers to the digit keys on your handset is described on page 87.

- ▶ Press and **hold** the required quick dial key.

If there is a valid line suffix at the end of the number in the directory (e.g.: #1), the number will be dialled via the line belonging to the suffix (page 111).

A number with a hash key (#) only at the end will be dialled via the default connection.

A number with a star (\*) at the end will be dialled via the non-default connection.

If no suffix is entered, the number will be dialled via the default connection. Exception: A dialling plan has been defined for the number (page 124).

## Sending the directory/call-by-call list to another handset

### Preconditions:

- ◆ The sending and receiving handsets must both be registered to the same base station.
- ◆ The other handset can send and receive directory entries.

 /  →  (Select entry; page 42)

→ **Options** → **Copy Entry / Copy List**  
→ **to Internal**

 Select the internal number of the receiving handset and press **OK**.

A successful transfer is confirmed by a message and confirmation tone on the receiving handset.

You can transfer several individual entries one after the other by responding **Yes** to the **Copy next entry?** prompt.

### Please note:

You can also send the complete **directory** via data transfer, without opening the directory:

 →  → **Data Transfer** → **Directory**

### Please note:

- ◆ Entries with identical numbers are not overwritten in the receiver handset.
- ◆ The transfer is cancelled if the phone rings or if the memory of the receiving handset is full.

### Gigaset S68H: transferring the directory entries as a vCard with Bluetooth

---

In Bluetooth mode (see page 94), you can transfer directory entries in vCard format, e.g. to exchange entries with your mobile.

Preconditions:

- ◆ Your own area code is stored in the phone (page 95)
- ◆ Bluetooth is activated (page 94)
- ◆ The device that you want to send the entries to (e.g. mobile), is registered with the handset as a Bluetooth device (page 94)

 →  (Select entry) → **Options**  
→ Copy Entry / Copy List

vCard via Bluetooth

Select and press **OK**.

The **Known Devices** list is displayed (page 94).

 Select device and press **OK**.

### Receiving a vCard with Bluetooth

---

If a device from the **Known Devices** (page 94) list sends a vCard to your handset, this occurs automatically and you are informed about it via the display.

If the sending device does not appear in the list, you will be asked on the display to enter the device PIN for the sending device:

 If necessary, enter the PIN for the **sending** Bluetooth device and press **OK**.

The transferred vCard is available as a directory entry.

### Copying a displayed number to the directory

---

You can copy numbers to the directory that are displayed in a list, e.g. the calls list or the last number redial list, in an SMS or during a call.

A number is displayed:



**Options** → Copy to Directory

Or:

 Press the display key.

The directory is opened.

**New Entry / Directory entry**  
Select and press **OK**.

 /  /   
Select and press **OK**.

The number is copied to the relevant number field (**Phone (Home) / Phone (Office) / Phone (Mobile)**).



- ▶ Complete the entry if necessary, see page 41.

During the number transfer from the answer machine list, the message playback is interrupted.

### Copying a number or e-mail address from the directory

---

In many operating situations, you can open the directory to copy a number or e-mail address, for example. Your handset need not be in idle status.



- ▶ Depending on the operating situation, open the directory with  or .

 Select an entry (page 42).

## Saving an anniversary in the directory

You can save an anniversary for every number in the directory and specify a time when you will receive a reminder call on the anniversary.

Anniversaries are automatically recorded in the calendar (page 92).

 →  (Select entry; page 42)

**View** **Edit** Press the display keys one after the other.

 Scroll to the **Annivers.:** line.

 Select **On**.

▶ Change multiple line input:

### Anniversary (Date)

Enter day/month/year in 8-digit format.

### Annivers. (Time)

Enter the hour/minute for the reminder call in 4-digit format.

### Annivers. (Signal)

Select the type of signal for the reminder.

▶ Save changes (page 147).

### Please note:

A time must be specified for reminder calls. If you select a visual signal, a time is not required and is automatically set to 00.00.

## Deactivating anniversaries

 →  (Select entry; page 42)

**View** **Edit** Press the display keys one after the other.

 Scroll to the **Annivers.:** line.

 Select **Off**.

**Save** Press the display key.

## Reminder call on an anniversary

A reminder call is signalled on the handset using the selected ringer tone.

You have the following options:

**SMS** Write an SMS.

**Off** Press the display key to acknowledge and end the reminder call.

## Viewing missed anniversaries

In idle status, you are reminded of an elapsed and unacknowledged anniversary by the **one-off** display of **Appoint.**

▶ View appointment:

**Appoint.** Press the display key.

You now have the following options:

**SMS** Write an SMS.

**Delete** Delete reminder.

After deleting, press the display key  or **Go Back**:

Back in idle status, **Appoint.** is no longer displayed.

You can also view missed anniversaries afterwards (see page 93).

## Using online directories

You can use online directories (= online directories and classified directories, e.g. "Yellow Pages") depending on your provider.

You can define which online directories you wish to use via the Web configurator (page 129).

### Exclusion of liability

Siemens Home and Office Communication GmbH & Co KG assumes no guarantee or liability for the availability of this service. The service may be discontinued at any time.

## Opening an online/classified directory

**Precondition:** The handset is idle and a VoIP connection is available.



 Press and **hold**. This opens the list of online directories. Provider-specific names appear in the display.

 Select directory (online directory or classified directory) from the list and press **OK**.

## Using the directory and lists

Or:

You can find the **Net Directory**, **Yellow Pages** entries for online directories in the local directories of the registered handsets. You can use these entries to access the online directories assigned to your handset (page 129).

- ▶ Open the directory with the  button.
- ▶ Select the **Net Directory** entry for the online directory or the **Yellow Pages** entry for the classified directory and press the talk key .

This establishes a connection to the online directory or the classified directory.

### Please note:

- The directory entries **Net Directory / Yellow Pages** are transferred to the handset when it is registered with the base station (page 81). Precondition: The handset can receive directory entries.
- You can also establish a connection to the online directory as follows:
  - ▶ When the handset is idle, dial **1#91** and then press the talk key .
  - ▶ To establish a connection to the classified directory, dial **2#91**.
  - ▶ To establish a connection to the Gigaset.net directory, dial **1188#9**.

Calls to the online directory are always free of charge.

## Searching for an entry

**Precondition:** You have opened the online telephone/classified directory.

- ▶ Making a multi-line entry:

**Surname:** (Online directory) /

**Category/Name:** (Classified directory)

Enter the name, part of a name or the trade sector (max. 30 characters).

**City:** Enter the name of the town in which the subscriber you are searching for lives.

**Number:** Enter the number (max. 30 characters).

- ▶ Press the display key **Search** to start the search.

You must make an entry in either **Surname:** or **Category/Name:** and in **City:** or in **Number.** Searching by number is only possible if supported by the online directory you have selected. Entering text see page 147.

A list of found towns will be displayed if the search returns more than one result:



Select the town.

Use **View** to display detailed information on the selected town.

If no matching town is found: Press **Edit** if you want to change the search criteria.

The entries for **Category/Name** and **City** are adopted and can be changed.



Press the display key to continue the search.

A corresponding message will appear on the display if no subscriber is found to match the search criteria. You have the following options:

- ▶ Press the display key **New** to start a new search.

Or

- ▶ Press the display key **Edit** to change the search criteria. The stated name and town are adopted and can be changed.

No hits will be displayed if the list of hits is too large. A message to this effect is displayed.

- ▶ Press the display key **Refine** to start a refined search (page 47).

Or

- ▶ Provider-dependent: You can view the list if the number of hits is shown on the display. Press the display key **View**.

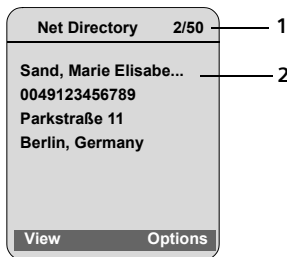

## Search result (hit list)

The search result is shown as a list on the display. Example:



1. 2/50: Consecutive number/total number of hits (only the consecutive number is displayed if the total number of hits >99)
2. Four lines with subscriber's name, trade sector, telephone number and address (possibly abridged)

You have the following options:

- ▶ You can scroll through the hit list with .
- ▶ Press the display key **View**. Displays the unabridged details of the entry (name, trade sector where applicable, address, telephone numbers). You can scroll through the entry with .

You have the following additional options via **Options**:

### Refine search

Refine search criteria and restrict list (page 47).

**New search** Start a new search.

### Copy to Directory

Transfer the entry number to the handset's directory (page 44). The surname is transferred to the name field of the directory.



## Calling subscribers

**Precondition:** A hit list is displayed.

- ▶ Select the entry and press the talk key .

This dials the number in the display if there is only one number.

A list of numbers appears if there is more than one number.

- ▶ Select the number with  and press the talk key  once again.

## Start detailed search

You can use the search options available in the detailed search (first name and/or street) to limit the number of hits returned by a previous search.

**Precondition:** A search result is displayed (hit list with multiple entries or a message indicating too many hits).

**Refine** Press the display key.

Or

**Options** → **Refine search**  
Select and press **OK**.

The search criteria from the previous search are adopted and entered in the corresponding fields.

**Surname:** (Online directory) /

**Category/Name:** (Classified directory)

If necessary, change name/ trade sector or extend partial name.



## Using the directory and lists

**City:** If necessary, change the name of the town.

**Street:** If necessary, change the name of the street (max. 30 chars.).

**First name:** (only in the online directory)  
If necessary, enter the first name (max. 30 characters).

**Search** Start detailed search.



## Last number redial list

---

The last number redial list contains the 20 numbers last dialled with the handset (max. 32 digits). If one of the numbers is in the directory, the corresponding name will be displayed.

## Dialling from the last number redial list



---

-  Press the key **briefly**.
-  Select an entry.
-  Briefly press/press and hold the talk key. The number is dialled using the selected connection type (page 26).

When a name is displayed, you can display the corresponding phone number by pressing the **View** display key.

## Managing entries in the last number redial list

---

-  Press the key **briefly**.
-  Select an entry.
- Options** Open menu.

The following functions can be selected with :

### Copy to Directory

Copying a displayed number to the directory (page 44).

### Automatic Redial

The selected number is automatically dialled at fixed intervals (at least every 20 seconds). The handsfree key flashes and "open listening" is activated.

- Party answers: press the talk key . The function is ended.
- Party does not answer: the call is terminated after approx. 30 seconds. The function is ended after pressing any key or after ten unsuccessful attempts.

### Display Number

(As in the directory, page 43)

### Delete Entry

Delete selected entry.

### Delete List

Delete complete list.



## Opening lists with the message key

---

You can use the message key  to open the following lists:

- ◆ Answer machine list
- ◆ Network mailbox, see page 78  
A separate list is displayed for each network mailbox.  
**Precondition:** Its number is saved in the base station, it is switched on (page 78, page 126) and the corresponding VoIP/fixed line network number is assigned to the handset as a receive number.
- ◆ SMS list, see page 55  
If **several** mailboxes are set up (page 57), several lists will be displayed, if required.
- ◆ Incoming e-mail list, see page 68  
The list is only shown if new messages have arrived in the mailbox from the incoming e-mail server.
- ◆ Calls list
- ◆ Messenger message list, see page 75  
The list is only shown on the handset that is online.

An advisory tone sounds as soon as a **new message** arrives in a list. The  key flashes (it stops when the key is pressed). In idle status, the display shows an icon for the new message:

Icon	New message...
	... in one of your network mailboxes or ... in the answer machine list
	... in calls list
	... in the SMS, messenger or e-mail list

The number of new entries is shown beneath the corresponding icon.

### List selection

Pressing the  button will only display lists that contain messages and also the network mailbox lists **Net AM: ...**

Lists with new messages are shown first and identified in bold. The number of messages received are shown in brackets.

If a list contains no new messages, the number of old messages will be shown. Exception: (0) is displayed for **Net AM: ...** network mailboxes.

Example:

Messages & Calls	
<b>Net AM: IP1</b>	<b>(1)</b>
<b>Ans M.:</b>	<b>(2)</b>
<b>Calls List:</b>	<b>(4)</b>
Net AM: Fxd. line	(0)
Net AM: IP2	(0)
	OK

▶ Select a list with  and press **OK**.

### Calls list

**Precondition:** Calling Line Identification (CLIP, page 29).

Depending on the type of list set, the calls list contains



- ◆ Received calls (marked with )
- ◆ Missed calls

The numbers of the last 30 calls are saved. Multiple calls from the same number will be stored once in the list of missed calls (the latest call). The number of calls from this number is shown in brackets after the entry.

Multiple calls from the same number are stored several times in the list of answered calls.

The list of missed calls does not contain calls that were answered and calls that were recorded by the answer machine.

#### Please note:

- Only calls to the receive numbers assigned to your handset are stored in the calls list (page 120).  
If no receive numbers are assigned, all calls will be stored in the calls list for all handsets.
- You can also call up the call history via the menu:  →  

### Setting the calls list type

 →   → Base → Calls List Type

**Missed Calls / All Calls**

Select and press **OK** ( = on).



Press and **hold** (idle status).

The calls list entries are retained when you change the list type.

### List entry in calls list

---

New messages are displayed at the top.

Example of list entries:



- ◆ List type in header: **Missed Calls**, **All Calls**
- ◆ Status of entry  
**Bold:** New entry
- ◆ Number or name of caller  
You can add the caller's number to the directory (page 44).
- ◆ Date and time of call (if set, page 11)

### Managing entries in the calls list

Pressing the display key **Delete** deletes the marked entry.

After pressing the display key **Options** you can select more functions with 

#### Copy to Directory

Copying a displayed number to the directory.

#### Information

If a URI was received and stored for a VoIP call, this will be shown. The URI is dialled if you press the talk key . The URI is not entered on the last number redial list.

#### Delete List

Delete complete list.

After exiting the calls list, all entries are set to "old" status and are no longer shown in bold.

### Selecting from the calls list

---

 → **Calls List: (2)**

 Select entry.

 Briefly press/press and hold the talk key. The number is dialled using the selected connection type (page 26).

### Answer machine list (Gigaset S675/S685 IP)

---

The answer machine list **Ans M.:** is only displayed on handsets that have at least one receive number in common with the answer machine.

You can use the answer machine list to listen to the messages stored on the base station answer machine.

The first new message received is displayed at the top of the answer machine list. Playback starts when the list is opened.

New messages are placed after old messages when they have been played back.

All messages are played back irrespective of the associated receive number.

Old messages are played back if the list does not contain any new messages.

## List entry in the answer machine list

Example of list entries:

Message Playback	
Susí Sorglos	
15.01.08	12:20
Louise Miller	
14.01.08	11:15
Delete	Options

- ◆ Status of entry  
**Bold:** New entry
- ◆ Number or name of caller  
You can add the caller's number to the directory (page 44).
- ◆ Call date and time (if set, page 11).

How to manage messages in the answer machine list is described on page 63.

## Dialling numbers from the answer machine list

 → Ans M.: (2)



Select entry.



Briefly press/press and hold the talk key. The number is dialled using the selected connection type (page 26).

## Making cost-effective calls

Using the Internet (VoIP) is the preferred cost-effective way of making calls.

You can also use your phone's cost control function for calls to fixed line or mobile phone networks. Open accounts with various VoIP providers who offer favourable rates for calls to other networks. In the phone configuration, define the best VoIP connections (account), e.g. for specific regional, national and mobile network prefixes, to be used when calls are made (**Dialling Plans**, page 124). Or define the VoIP connection to be used when dialling the number (dialling with line suffix, page 27).

If you are using your fixed line network phone, choose a network provider who offers particularly favourable rates (call-by-call). You can manage call-by-call numbers in the call-by-call list.

### Linking call-by-call numbers with one number

You can prefix a network provider's number ("chaining") to numbers dialled via a fixed line network.



Open call-by-call list.



Select entry (call-by-call number).

**Options**

Press the display key.

### Display Number

Select and press **OK**.



Enter number or dial number from the directory (page 44).



Briefly press/press and hold the talk key so that the number is dialled via the fixed line network. Both numbers are dialled.

## Making cost-effective calls

### **Please note:**

You can also dial "chained" numbers via a fixed line network by adding the line suffix #0 (for the fixed line network) to the end of the number. Alternatively, you can define appropriate rules for call-by-call numbers (page 124).

## Displaying the call duration

The duration of each call appears in the display for calls made via a fixed line network and VoIP

- ◆ during the conversation,
- ◆ until about three seconds after the call has ended if you do not replace the handset in the charging cradle.

### **Please note:**

The actual duration of the call can vary from that shown by a few seconds.

## SMS (text messages)

You can only send and receive SMS messages via the fixed line network.

When an SMS is sent, the base station automatically establishes a connection via the fixed line network.

Your phone is supplied ready for sending SMS messages immediately.

### Preconditions:

- ◆ Calling Line Identification is enabled for your fixed line network connection.
- ◆ Your network provider supports SMS in the fixed line network (information on this can be obtained from your network provider).
- ◆ You are registered with your service provider to send and receive SMS.

SMS messages are exchanged between SMS centres operated by service providers. You must enter the SMS centre through which you wish to send and receive SMS messages into your phone. You can receive SMS messages from **every** SMS centre that is entered, provided you have registered with your service provider.

Your SMS messages are sent via the **Service Centr.** that is entered as the **active send service centre**. However, you can activate any other SMS centre as the active send service centre to send a current message (page 58).

If no SMS service centre is entered, the SMS menu only contains the entry **Settings**. Enter an SMS service centre (page 58).

Information on writing an SMS can be found in the appendix:

- ◆ For how to enter text, see page 147.
- ◆ Writing using the predictive text tool EATONI, see page 148.

### Rules

- ◆ For more than 160 characters, the SMS will be sent as a **linked** SMS (up to four SMS messages each containing 152 or 153 characters, depending on the length of the linking information). The following will be shown on the top right in the header when an SMS is being written (example):





- 1 Maximum number of characters you can still write or attach.
- 2 Number of SMS messages that need to be linked for the text written so far.

**Please note** that linking SMS messages usually incurs higher charges.

### Please note:

- ◆ If your phone is connected to a PABX, see page 59.
- ◆ To receive SMS messages you must be registered with your service provider.

## Registering with the registration assistant

The first time you open the  →  → **SMS** menu, you will be asked whether you wish to be registered automatically with all entered SMS centres (see page 58). Confirm with **Yes**. You can now receive SMS messages from all SMS centres whose numbers you have entered.

If you answer with **No**, automatic registration will be cancelled. You can start automatic registration at a later time via the menu:

**Precondition:** SMS centres have been entered.

 →  → **SMS** → **Settings**  
→ **Subscribe to SMS**

The registration assistant does not support setting up personal mailboxes (page 57).

## Writing/sending an SMS

### Writing an SMS

 →  → SMS

**Mailbox 2** Select mailbox if necessary and press **OK** (page 57).

 Enter mailbox PIN if necessary and press **OK**.

**New SMS** Select and press **OK**.

 Write an SMS.

#### Please note:

- Entering text with and without EATONI predictive text is described from page 148.
- EATONI is activated as a default setting. How to activate/deactivate EATONI, see page 149.

### Sending an SMS

 Press the talk key



or:

**Options** Press the display key.

**Send** Select and press **OK**.

Then:

**SMS** Select and press **OK**.

 /  /   
Select number with area code (even if you are in that area) from the directory or call-by-call list, or enter number directly. For sending SMS to an SMS mailbox: add the mailbox ID to the **end** of the number.

**Send** Press the display key.

The SMS will be sent as soon as your phone's fixed line network connection is free.

#### Please note:

- If you are interrupted by an external call while writing an SMS, the text is automatically saved in the draft message list.
- If the memory is full, or if the SMS function on the base station is being used by another handset, the operation is cancelled. An appropriate message appears in the display. Delete SMS messages you no longer require or send the SMS later.

## Using other functions

**Precondition:** You are writing an SMS.

**Options** Open menu.

The following functions can be selected with :

#### Send

Send an SMS.

#### Save

Save an SMS in the draft message list (page 54).

#### Insert E-mail Adr.

Add an e-mail address to the message text.

#### Predictive Text

Activate/deactivate predictive text EATONI, page 148.

#### Select Language

For EATONI: select the language in which you wish to write the text and press **OK**.

## Draft message list

You can save an SMS in the draft message list and edit and send it later.

### Saving an SMS in the draft message list

► Write an SMS (page 54).

**Options** Press the display key.

**Save** Select and press **OK**.

#### Please note:

After saving, the SMS editor will be displayed again with your SMS. You can continue writing the text and save it again. The SMS that was saved previously will be overwritten.

## Opening the draft message list

 →  → SMS → (Mailbox, mailbox PIN)

### Outgoing (3)

Select and press **OK**. The number of SMS messages in the list will be shown in brackets (e.g. (3)).

The first list entry is displayed, e.g.

1234567890
15.01.08 09:45

## Reading or deleting SMS messages

► Open the draft message list and then:



Select SMS.

**Read**

Press the display key. The entry will be displayed. Scroll line by line using .

Or:

**Options**

Open menu.

**Delete Entry** Press **OK**. The selected SMS message is deleted.

You can use **Options** → **Delete all** to delete every SMS in the draft message list.

## Writing/changing an SMS

► You are reading an SMS in the draft message list.

**Options**

Open menu.

You have the following options:

### New SMS

Write a new SMS and then send (page 54) or save it.

### Edit

Edit the text of the saved SMS and then send it (page 54).

### Character Set

Text is shown in the selected character set.

## Receiving an SMS

All received SMS messages are saved in the incoming message list. Linked SMS messages are displayed as **one** message. If this is too long (it consists of too many linked individual SMS messages) or if it was not fully transmitted, it will be split into several individual SMS messages.

Since an SMS remains in the list even after it has been read, you should **regularly delete SMS messages from the list**.



The display tells you if the SMS memory is full.

► Delete SMS messages you no longer require (page 56).

## Incoming message list

The incoming message list contains:

- ◆ All received SMS messages, starting with the most recent.
- ◆ SMS messages that could not be sent due to an error.

New SMS messages are signalled on all Gigaset S67H/S68H handsets by the  icon in the display, the flashing message key  and an advisory tone.

### Opening the incoming message list with the key

 Press.

Select a mailbox if necessary and enter the mailbox PIN.

The incoming message list is displayed as follows (example):

SMS:	(2)	1
		2

- 1 **Bold:** number of new entries
  - Regular:** number of read entries
  - 2 Name of mailbox, here: general mailbox
- Open list with **OK**.





## SMS (text messages)

An entry in the list is displayed as in the following example:

1234567890	1
15.01.08 09:45	2

- 1 Number of the sender or name of the directory entry
- 2 **SMS status:**  
**Bold:** new unread SMS messages  
**Regular:** old read SMS messages

### Opening the incoming message list via the SMS menu

 →  → **SMS** → (Mailbox, mailbox PIN) → **Incoming (2)**

### Reading or deleting individual SMS messages

- ▶ Open the incoming message list.
- ▶ Continue as described in "Reading or deleting SMS messages", page 55.

After you have read a new SMS, it is given the status "Old" (it is no longer shown in bold).

### Changing the character set

- ▶ Read the SMS (page 56):

If you cannot see any text or symbols, the SMS may have been written with a different character set.

**Options** Press the display key.

#### Character Set

Select and press **OK**.

 Select character set and press **OK**.

Text is shown in the selected character set.

### Deleting the incoming message list

All **new and old** SMS messages in the list are deleted.

- ▶ Open the incoming message list.

**Options** Open menu.

**Delete all** Select, press **OK** and confirm with **Yes**. The list is cleared.

## Replying to or forwarding SMS messages

- ▶ Read the SMS (page 56):

**Options** Press the display key.

You have the following options:

#### Reply

Write and send a reply SMS directly (page 54).

#### Edit

Edit the text in the SMS and then send it (page 54).

### Forwarding an SMS

- ▶ You are reading an SMS (page 56):

**Options** Press the display key.

**Forward** Select and press **OK**. For further information, see page 54.

## Adding a number to the directory

### Copying the sender's number

- ▶ Open the incoming message list and select SMS (page 55).

**Options** Press the display key. For further information, see page 44.

#### Please note:

- You can create a special directory for SMS messages within your main directory by putting a star (\*) before the names.
- An attached mailbox identifier is added to the directory. It must be deleted for 'normal calls'.

### Dialling numbers from SMS texts/ transferring to the directory

- ▶ Read the SMS (page 56) and scroll to the telephone number.

The digits are reverse-highlighted.

 **Briefly press/press and hold** the talk key to dial the number.

Or:

 Press the display key to transfer the number to the directory. For further information, see page 44.

**Please note:**

- The + symbol is not transferred for international area codes.
  - ▶ You should then enter '00' at the start of the number.
- If an SMS contains several numbers, the next number will be highlighted if you scroll down until the first number disappears from the display.

If you wish to use the number to send an SMS:

- ▶ Save the number with the local area code (dialling code) in the directory.

## Notification by SMS

---

You can be notified via SMS about missed calls and also about new answer machine messages.

**Precondition:** For missed calls, the caller's number (CLI) must have been transmitted.

Notification is sent to your mobile phone or another phone with SMS functionality. You only need to save the phone number to which notification should be sent (notification number) and set the notification type.

**Please note** that your network provider will usually charge for SMS notifications.

### Saving the notification number

 →  → SMS → Settings  
→ Notify Number



Enter the number (including area code) to which the SMS is to be sent.

**Save**

Press the display key.



Press and **hold** (idle status).

### Warning:

Do **not** enter your own fixed line number for the notification of missed calls. This can lead to chargeable endless looping.

### Setting the notification type

 →  → SMS → Settings  
→ Notify Type

- ▶ Change multiple line input if necessary:

#### Missed Calls:

Select **On** if you require SMS notification.

#### Ans Machine:

Select **On** if you require SMS notification.

- ▶ Save changes (page 147).

## SMS mailboxes

---

The **general mailbox** is the default setting. Anyone can access this mailbox and it cannot be protected by a PIN. You can additionally set up three **personal mailboxes** and protect these with a **PIN**. Each mailbox is identified by a name and a "mailbox ID" (a kind of extension number).

### Please note:

- ◆ If you operate a number of devices (base stations) with SMS functionality on a single phone line, then each SMS mailbox ID may only occur once. In this case you must also change the preset ID of the general mailbox ("0").
- ◆ You can only use personal mailboxes if your service provider supports this function. You can tell whether this is the case by the addition of a star (\*) to the number of a (preset) SMS centre.
- ◆ If you have forgotten your mailbox PIN, you can reset it by restoring the base station's default settings. This will **delete all SMS messages from all mailboxes**.

## Setting up and changing a personal mailbox

---

### Setting up a personal mailbox

 →  → SMS → Settings  
→ SMS Mailboxes

 Select mailbox, e.g. Mailbox 2, and press **OK**.

▶ Change multiple line input:

#### On/Off:

Activate or deactivate mailbox.

#### ID:

Select mailbox ID (0–9). You can only select the available numbers.

#### Protection:

Activate/deactivate PIN protection.

#### PIN

If necessary, enter 4-digit PIN.

▶ Save changes (page 147).

Active mailboxes are marked with  in the mailbox list. They are shown in the SMS list and can, if necessary, be displayed by pressing the message key .

### Deactivating a mailbox

▶ Set **On/Off:** to **Off**. Confirm message with **Yes** if necessary.

All SMS messages saved in this mailbox will be deleted.

### Deactivating PIN protection

▶ Set **Protection:** to **Off**.

The mailbox PIN is reset to "0000".

### Changing the name of a mailbox

 →  → SMS → Settings → SMS Mailboxes →  (Select mailbox)

**Edit** Press the display key.

 Enter new name.

**Save** Press the display key.

 Press and **hold** (idle status).

### Changing a mailbox's PIN and ID

 →  → SMS → Settings → SMS Mailboxes →  (Select mailbox)

 Enter mailbox PIN if required and press **OK**.

▶ Set **ID:**, **Protection:** and **PIN** (page 58).

## Sending an SMS to a personal mailbox

---

To send an SMS to a personal mailbox, the sender must know your ID and enter it after your number.

▶ You can send your SMS contact an SMS via your personal mailbox.

Your SMS contact will then receive your SMS number with current ID and can save it in their directory. If the ID is invalid, the SMS will not be delivered.

## Setting SMS centres

---

### Entering/changing SMS centres

---

▶ You should find out about the services and special functions offered by your service provider **before you make a new application** and/or before you delete pre-configured call numbers.

 →  → SMS → Settings → Service Centres

 Select SMS centre (e.g. Service Centr. 1) and press **OK**.

▶ Change multiple line input:

#### Active Send:

Select **Yes** if SMS messages are to be sent via the SMS centre. For the SMS centres 2 to 4, the setting only applies to the next SMS.

#### SMS:

Press the display key **Edit**. Enter the number of the SMS service and insert a star if your service provider supports personal mailboxes.

▶ Save changes (page 147).

**Please note:**

Ask your service provider for details on how to enter service numbers if you wish to use personal mailboxes (precondition: your service provider supports this function).

## Sending an SMS through another SMS centre

- ▶ Activate the SMS centre (2 to 4) as the **active send service centre**.
- ▶ Send the SMS.

This setting only applies to the next SMS to be sent. Thereafter, the setting returns to **Service Centr. 1**.

## SMS on a PABX

- ◆ You can only receive an SMS when the **Calling Line Identification is forwarded** to the extension of the PABX (**CLIP**). The CLIP evaluation of the phone number for the SMS centre takes place in your **Gigaset**.
- ◆ If required, you must prefix the number for the SMS centre with the access code (depending on your PABX).  
If in doubt, test your PABX, e.g. by sending an SMS to your own number: once with and once without the access code.
- ◆ When you send SMS messages, your sender number may be sent without your extension number. In this case the recipient cannot reply to you directly.

Sending and receiving SMS messages **on ISDN PABXs** is only possible via the MSN number assigned to your base station.

## Activating/deactivating SMS function

If you deactivate the SMS function, you cannot send or receive any SMS messages with your phone.

The settings you have made for sending and receiving SMS messages (e.g. the call numbers of the SMS centres) and the entries in the incoming and draft message lists are saved even after you turn off your phone.



Open menu.



Enter the digits.



Deactivate SMS function.

Or:



Activate SMS function (default setting).

## SMS troubleshooting

### Error codes when sending

EO	Calling Line Identification permanently withheld (CLIR) or Calling Line Identification not activated.
FE	Error occurred during SMS transfer.
FD	Connection to SMS centre failed; see self-help.

### Self-help with errors

The following table lists error situations and possible causes and provides notes on troubleshooting.

<p>You cannot send messages.</p> <ol style="list-style-type: none"><li>1. You have not requested the CLIP service (Calling Line Identification Presentation).<ul style="list-style-type: none"><li>▶ Ask your service provider to enable this service.</li></ul></li><li>2. SMS transmission has been interrupted (e.g. by a call).<ul style="list-style-type: none"><li>▶ Re-send the SMS.</li></ul></li><li>3. Network provider does not support this feature.</li><li>4. No number or an invalid number is entered for the SMS centre set as the active send service centre.<ul style="list-style-type: none"><li>▶ Enter the number (page 58).</li></ul></li></ol>
<p>You receive an incomplete SMS.</p> <ol style="list-style-type: none"><li>1. Your phone's memory is full.<ul style="list-style-type: none"><li>▶ Delete old SMS messages (page 56).</li></ul></li><li>2. The service provider has not yet sent the rest of the SMS.</li></ol>
<p>You have stopped receiving SMS messages.</p> <ol style="list-style-type: none"><li>1. You have changed the ID of your mailbox.<ul style="list-style-type: none"><li>▶ Give your SMS contacts your new ID or undo the change (page 58).</li></ul></li><li>2. You have not activated your mailbox.<ul style="list-style-type: none"><li>▶ Activate your mailbox (page 58).</li></ul></li><li>3. Call forwarding is activated with <b>When: All Calls</b> for a fixed line connection, and with <b>All Calls</b> for the network mailbox.<ul style="list-style-type: none"><li>▶ Change the call forwarding.</li></ul></li></ol>

The message is played back.

1. The "display call number" service is not activated.
  - ▶ Ask your service provider to activate this function (chargeable).
2. Your mobile phone operator and your fixed line network SMS service provider have not agreed on a co-operation.
  - ▶ Obtain information from your fixed line network SMS service provider.
3. Your end device has been recorded by your SMS provider as having no fixed line network SMS functionality, i.e. you are no longer registered with the provider.
  - ▶ Start the registration assistant for automatic registration (see page 53).
  - ▶ Have the device (re-)registered to receive SMS messages.

Messages are only received during the day.

1. The terminal is recorded in your SMS provider's database as having no fixed line network SMS functionality, i.e. you are no longer registered with the provider.
  - ▶ Start the registration assistant for automatic registration (see page 53).
  - ▶ Register the terminal (again) for SMS reception (see above).

## Gigaset S675/S685 IP: operating the base station answer machine

You can operate the answer machine that is integrated in the base station via the handset or via remote operation (other phone/mobile phone). You can record your own announcement message or advisory message via the handset.

### Please note:

Connections to the answer machine (internal and external) are not established using broadband.

### Receive numbers

You can use your phone's Web configurator to set which of your phone numbers your answer machine is to accept as soon as it is switched on (page 121). You can assign your phone any amount of phone numbers as receive numbers (VoIP, fixed line network, Gigaset.net).

All calls accepted by the answer machine are stored in sequence in the answer machine independently of the receive number and displayed in the same answer machine list.

Any registered handset to which at least one receive number from the answer machine has been assigned as a send or receive number can access the answer machine list (page 120).

After a new phone number is configured (a new VoIP account), it is first assigned to the answer machine as a receive number.

### Parallel calls

If a caller is connected to the answer machine and a second call for the answer machine comes in on a different line (fixed line network or VoIP), the second caller hears the ringing tone. The answer machine will answer the second call if:

- ◆ the connection with the first caller has ended and
- ◆ the set time period for the answer machine to answer a call (page 65) has expired.

### Announce only/answer and record mode



You can use the answer machine in two different modes.

- ◆ In **Ans. & Record** mode, the caller hears the announcement and can then leave a message.
- ◆ In **Announce Only** mode, the caller hears your announcement but cannot leave a message.

## Operation via the handset

The handset loudspeaker activates **automatically** if you receive an acoustic prompt or message while operating. You can switch it off with the handsfree key .

### Activating/deactivating the answer machine

 →  → Voice Mail → Local AM  
→ Ans Machine (☑ = on)

When the answer machine is activated, the remaining memory time is announced. If the time has not yet been set (page 11), an appropriate announcement is made. The ∞ icon appears in the display.

The answer machine accepts calls for all the receive numbers assigned to it (page 121).

### In answer and record mode

If the memory is full the answer machine automatically switches to announce only mode.

- ▶ Delete old messages.

The answer machine reverts automatically to answer and record mode.

## Selecting announcement mode

You can choose between **Ans. & Record** and **Announce Only**.

 →  → **Voice Mail** → **Local AM**  
→ **Announcements** → **Set Ans. Mode**  
→ **Ans. & Record / Announce Only** ( = on)

 Press and **hold** (idle status).

The selected mode is saved even after the answer machine is deactivated.

The selection process will be cancelled if the message memory is already full when you change to **Ans. & Record** mode. You will be requested to delete old messages. The answer machine stays in announce only mode **Announce Only**.



- ▶ Delete old messages.

Only after messages have been deleted can you switch the answer machine to answer and record mode.

## Setting "Answer & Record" or "Announce Only" by toggling

You can use the **Ans Mode Time** setting to change over the announcement mode for a specific period.

**Example:** **Ans. & Record** mode is set. If you activate **Ans Mode Time** and set the time period **From:** 18:00, **Until:** 08:00 the answer machine will switch to **Announce Only** mode every day at 18:00 (if it is switched on). It will switch back to **Ans. & Record** mode at 08:00 the next day.

 →  → **Voice Mail** → **Local AM**  
→ **Announcements** → **Set Ans. Mode**  
→ **Ans Mode Time** ( = on)

- ▶ Change multiple line input:

**From:**

Enter hours/minutes for the start of the period in 4-digit format.

**Until:**

Enter hours/minutes for the end of the period in 4-digit format.

**Activation:**

Select **On** or **Off**.

- ▶ Save changes with **Save**.

If the messages memory is full and **Activation: On** has been selected, saving is interrupted and you will receive an instruction to delete old messages.

- ▶ Delete old messages and repeat the setting.

As soon as you change the announcement mode (page 62), the **Ans Mode Time** function is automatically deactivated. You may have to re-activate it if required.

If you do not enter a time for **From: / Until;** **Ans Mode Time** will still be activated but the machine will not switch to announcement mode.



## Recording a personal announcement/notification

Pre-recorded announcements are stored in your telephone for both announcement modes. The pre-recorded announcements are used if there is no personal announcement for the mode concerned.

 →  → **Voice Mail** → **Local AM**  
→ **Announcements** → **Record Announcement / Record Anc Only**

**OK** Press the display key to start the recording.

When the recording starts, the handset changes to handsfree mode. You hear the ready tone (short tone).

- ▶ Now speak your announcement (at least 3 secs.).  
Use  or  to cancel recording and **OK** to restart the recording process.

The recording is cancelled if the answer machine memory is full.



- ▶ Delete old messages and repeat recording if required.

## Stop recording:

**End** Press the display key.

After recording, the announcement is played back for you to check.



You can re-record the announcement with **New**.

You can cancel playback by pressing  or .

### Please note:

- ◆ Recording ends automatically if the maximum recording time of 170 seconds is exceeded or there is a break in speech for more than 2 seconds.
- ◆ If you cancel the recording, the previously recorded announcement will be deleted. The pre-recorded announcement will be used again.
- ◆ The recording is cancelled if the answer machine memory is full.
  - ▶ Delete old messages and repeat recording if required.
- ◆ If an external call is received during a recording for one of the handset's receive numbers, the recording is interrupted and the call is signalled on the handset.

## Playing back announcements



 →  → Voice Mail → Local AM  
→ Announcements → Play Announcement /  
Play Anc Only

If you have not recorded a personal announcement, the relevant pre-recorded announcement is played.

Record a new announcement while playing back the announcement:

**New** Press the display key. For further information, page 62.

## Deleting announcements/announcement only



 →  → Voice Mail → Local AM  
→ Announcements → Del Announcement /  
Del Anc Only

**Yes** Press the display key to confirm the prompt.

 Press and **hold** (idle status).

Once you have deleted your announcement, the relevant pre-recorded announcement will be used again. You cannot delete the pre-recorded announcements.

## Playing back messages

New messages that have not yet been heard are indicated by the  icon in the display and by the  key flashing on the handset.

You can start to play back the messages in two ways:

- ◆ Open the answer machine list with the message key.
- ◆ If the answer machine is set for fast access (page 66): press and **hold** key .

### Please note:

All messages are played back irrespective of their receive number.

## Listening to messages via the answer machine list

**Precondition:** At least one of your handset's send/receive numbers matches the receive number of a stored message.

The date and time of each message is logged in the answer machine list (provided it has been set, page 11) and displayed during the playback. If Calling Line Identification is activated, the caller's number is displayed. If the caller's number is saved in the directory, their name is displayed.

 Press the message key.

**Ans M.:** Select and press **OK**.

An announcement informs you if there are new or old messages.

If there are new messages, playback begins with the first new message. If the message has been saved with the date and time, you will hear an appropriate announcement before playback begins. All messages are played back irrespective of the receive number.



After the last new message you will hear the end tone and an announcement about how much recording time remains.

You can listen to old messages if there are no more new messages. Begin playback as described above.

### Listening to messages via key



**Preconditions:** The answer machine has been set to fast access (page 66). At least one of your handset's send/receive numbers matches the receive number of a stored message (page 121).



▶ Press and hold key .



The stored messages are now played back.

### Pausing and controlling playback

During message playback:

 Pause playback. Press  again to resume.

 or  Skip to the previous message.

 or  Skip to the next message.

2 x  Skip to next-but-one message.

If playback is interrupted for over a minute, the answer machine returns to idle status.

### Marking a message as "new"

A previously played back "old" message is displayed as a "new" message again.

#### During message playback or pause:

 Press the star key.

**Or:**

**Options** Open menu.

#### Mark as New

Select and press **OK**.

Playback of the current message is cancelled. Playback of next message starts, if applicable.

The  key on the handset flashes.

### Copying the phone number of a message to the directory

See "Copying a displayed number to the directory", page 44.

### Deleting messages

---

You can either delete all old messages together or individually.

#### Deleting all old messages

During playback or pause:

**Options** Press the display key.

#### Del All Old Msgs

Select and press **OK**.

**Yes** Press the display key to confirm the prompt.

All old messages are deleted irrespective of the receive number.

#### Deleting individual old messages

During playback or pause:

**Delete** / 

Press the display key or  key.

#### Please note:

You can delete a new message as soon as playback has started.

### Picking up a call from the answer machine

---

You can pick up a call while the answer machine is recording or is being operated via remote operation:

 / **Accept**

Press the talk or display key.

Recording stops and you can speak to the caller.

If 3 seconds of the call have already been recorded when you pick it up, the call will be displayed as a new message. The  key on the handset flashes.

## Forwarding an external call to the answer machine

You can forward an incoming external call to the answer machine.

**Preconditions:** There is sufficient free memory space. One of your handset's send/receive numbers matches a receive number of the answer machine.

An external call is signalled on the handset:



Press the display key.

The answer machine starts immediately in recording mode and records the call. The set time for the call acceptance (page 65) is ignored.

The display key  will not be displayed if the memory is full.

## Activating/deactivating two-way recording

You can record an **external** call with the answer machine.

**Precondition:** You are conducting an external call. At least one of the handset's send/receive numbers is assigned to the answer machine as a receive number (page 121).

- Inform the caller that the call is being recorded.

### Options

Press the display key.

### Two Way Record

Select and press **OK**.

The two-way recording is indicated on the display by an advisory text and is added to the answer machine list as a new message.

### End

Press the display key to stop the two-way recording.

The maximum recording time depends on the memory available on the answer machine. If the memory is full, you will hear an end tone and the recording is aborted. The conversation recorded up to

the end tone is then allocated to the answer machine list as a new message.

### Please note:

You can activate two-way recording for conference calls and toggling when making calls via a fixed line network.

## Activating/deactivating call screening

During recording of a message you can screen a call via the handset loudspeaker.

**Precondition:** The number called is assigned to the handset as a receive number (page 120).

## Permanently activating/deactivating call screening

 →  → Voice Mail → Local AM

### Call Screening

Select and press **OK** ( = on)



Press and **hold** (idle status).

## Deactivating call screening for the current recording

You can deactivate the **Call Screening** function for the current call during recording via the handset.



Briefly press the end call key.

## Setting up the answer machine

The answer machine has already been preset at the factory. Make individual settings using the handset.

## Call acceptance/charge saving function for remote operation

You can set when you want the answer machine to accept a call.

The options are: **0 sec.**, after **10 sec.**, **18 sec.** or **30 sec.** and the cost-saving setting **Automatic**.

In **Automatic** mode, the following applies for call acceptance:

- ◆ If there are no new messages, the answer machine accepts a call after **18 seconds**.
- ◆ If new messages are present, the answer machine accepts a call after **10 seconds**.

When operating remotely you can tell after approx. 15 seconds that there are no new messages (otherwise the answer machine would already have accepted your call). There will be no call charges if you hang up now.

 →  → **Voice Mail** → **Local AM**  
→ **Ring Delay**

 Select **0 sec. / 10 sec. / 18 sec. / 30 sec. / Automatic**.

**Save** Press the display key.

 Press and **hold** (idle status).

## Setting the recording time

You can set the maximum recording time of a message. You can choose between: **60 Sec, 120 Sec, 180 Sec** or **Maximum**.

 →  → **Voice Mail** → **Local AM**  
→ **Message Length**

 Select the recording time.

**Save** Press the display key.

## Setting the recording quality

Set the quality you require for your recordings. The options are: **Standard, High, Excellent**. If the quality is higher, the maximum recording time is reduced.

 →  → **Voice Mail** → **Local AM**  
→ **Record Quality**

 Select the recording quality.

**Save** Press the display key.

### Please note:

Your announcements are always recorded in best quality.

## Configuring the network mailbox for fast access

You can assign the local answer machine or one of your network mailboxes to key  for fast access (page 79). This setting is handset-specific.

### Configuring the local answer machine for fast access

**Precondition:** At least one of your handset's send/receive numbers matches a receive number of the answer machine.

 →  → **Voice Mail** → **Set Key 1**

**Local AM** Select and press **OK**.

 Press and **hold** (idle status).

### Listening to messages on the answer machine

**Precondition:** The answer machine is set for fast access on the handset.

 Press and **hold**.

The messages are now played back. Hands-free operation is activated. You will hear the answer machine announcement.

 If necessary, press the hands-free button to switch it off.

## Operating when on the move (remote operation)

You can check and activate your answer machine from any other telephone (hotel, pay phone etc.), or initiate ringback from the answer machine with an SMS.

### Preconditions:

- ◆ You have set a system PIN other than 0000 (page 96).
- ◆ The phone you are using for remote operation has touch tone dialling (DTMF), i.e. you hear different tones when you press the keys. Alternatively, you can use a code transmitter (available from your mobile phone retailer).

**Please note:**

Remote operation via VoIP connections is possible as long as DTMF signals are transmitted (depending on the provider) as SIP info messages, audible signals in the voice channel (inband or audio) or as special RTP data packets (pursuant to RFC2833).

## Calling the answer machine and playing back messages

**Precondition:** Your answer machine is activated.



Dial your own number that is assigned to the answer machine as a receive number.



When you hear your announcement, press and enter the system PIN.

You will be informed whether any new messages have been recorded. The messages are now played back. All messages are played back irrespective of their receive number. After the new messages, the old messages are played back. Finally, the remaining memory time is given.

You can control message playback by means of the keypad.

**Please note:**

The answer machine will terminate the connection under the following circumstances:

- An incorrect system PIN has been entered.
- There are no messages in the answer machine
- After the remaining memory announcement

## Operating the answer machine via the keypad

The following keys are used for operation:

- 1** Previous:  
Go to the start of the current message. Press repeatedly to go to the previous messages.
- 2** Stop/resume:  
Stop playback. Press again to resume.  
If there is a pause lasting longer than one minute, the connection to the answer machine is terminated.
- 3** Next:  
Skip to next message. Press several times to go to the following messages.
- \*** New:  
Mark current message as "new". Start playback of the following message.
- 0** Delete:  
Delete current message.

## Cancelling remote operation

- ▶ Press the end call key or replace the receiver.

## Activating the answer machine

- ▶ Phone home and allow the phone to ring for around a minute. Use a phone number that has been assigned to the answer machine as a receive number.

You hear: "Please enter PIN".



Enter system PIN.

Your answer machine will be activated in the set mode (page 62). It tells you how much memory time is left.



The messages are now played back.

The answer machine cannot be deactivated remotely.

## E-mail notifications

Your phone will notify you when new e-mail messages have been received on your incoming e-mail server.

You can set your phone to periodically connect to your incoming e-mail server and check whether you have new e-mail.

Any new messages that have been received are displayed on all Gigaset S67H/S68H handsets that have been registered: you will hear an advisory tone, the message key  will flash and the  icon will be displayed in the idle display.

### Please note:

The  icon is also displayed if new SMS messages or messenger messages have been received.

If new e-mail messages have been received, pressing the message key  will display them in the E-mail: list.

You can use your phone to connect to the incoming e-mail server and display the sender, date and time of receipt and subject for every e-mail message in the list of incoming mail (page 68).

### Preconditions:

- ◆ You have set up an e-mail account with an Internet provider.
- ◆ The incoming e-mail server uses the POP3 protocol.
- ◆ You have stored the name of the incoming e-mail server and your personal access data (account name, password) in the phone (page 128).

## Opening the incoming e-mail list

 →  → E-mail

Or if new e-mail messages have been received (the message key  is flashing):

 → E-mail:

The telephone establishes a connection to the incoming e-mail server. A list of e-mail messages that are stored there will be displayed.

New unread messages appear above old read messages. The most recent entry is at the head of the list.

The following details are displayed for each e-mail: name or e-mail address of the sender (one line, abbreviated if necessary) and date and time (date and time will only display correct values if sender and recipient are located in the same time zone).

Example display:

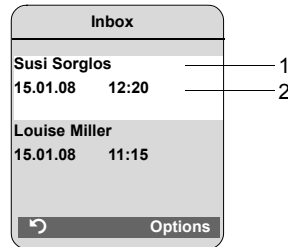

1 E-mail address or name transmitted by the sender  
**Bold:** New message.

2 Date and time of receipt of e-mail message

If the incoming message list on the incoming e-mail server is empty, **No entries** will appear in the display.

**Please note:**

Many e-mail providers operate standard spam protection measures. E-mail messages classified as spam are stored in a separate folder and are therefore not shown on the list of incoming mail.

Some e-mail providers allow you to deactivate spam protection or show spam e-mails on the list of incoming mail.

Other e-mail providers may send a message to the Inbox when a new spam e-mail is received. This is to inform you that a suspected spam e-mail has been received.

Date and sender of this mail are repeatedly updated, so that it is always displayed as a new message.

**Messages when establishing a connection**

The following problems may occur when connecting to the incoming e-mail server. The messages are displayed in the handset's display for a few seconds.

**Server not accessible!**

The connection to the incoming e-mail server could not be established. This may have the following causes:

- Incorrect entry for name of incoming e-mail server.
- Temporary problems with the incoming e-mail server (server is down or is not connected to the Internet).
- ▶ Check settings (page 128).
- ▶ Try again later.

**Currently not possible!**

The resources your phone requires to make the connection are busy, e.g.:

- Two VoIP connections have already been made.
- Another handset is currently connected to the incoming e-mail server.
- ▶ Try again later.

**Log-in failed!**

Error when logging in to the incoming e-mail server. This may have the following cause:

- Incorrect entries for name of incoming e-mail server, user name and/or password.
- ▶ Check settings (page 128).

**Mailbox settings incomplete!**

Incomplete entries for name of incoming e-mail server, user name and/or password.

- ▶ Check settings and complete if necessary (page 128).

**Viewing the message header of an e-mail**

**Precondition:** You have opened the incoming mail list (page 68).



Select e-mail entry.



Press the display key.

The subject of the e-mail message will be displayed (max. 120 characters).



Press the display key to return to the incoming message list.

**Please note:**

If the header is formatted in HTML it may be displayed differently to headers on the PC e-mail client.

## Viewing an e-mail sender's address

---

**Precondition:** You have opened the incoming mail list (page 68).



Select e-mail entry.

**From**

Press the display key.

The sender's e-mail address is shown in full.



Press the display key to return to the incoming message list.

Example:



## Deleting an e-mail

---

**Precondition:** You have viewed the message header or the sender's address of an e-mail (page 69).

- ▶ Select **Options** → **Delete E-mail** and press **OK**.

The e-mail is deleted from the incoming e-mail server.

## Messenger

The messenger on your phone makes **instant messaging** possible (immediate message transfer, chatting). The phone supports the XMPP messenger (Jabber).

Instant messaging refers to communication between "friends" on the Internet. Subscribers exchange short messages, which are forwarded immediately. This gives rise to a flowing "conversation" similar to chatting.

The precondition for this form of communication is that both subscribers have a connection to the **messenger server** of the same instant messaging provider. Therefore, both subscribers must be "**online**". The messenger server forwards the messages to the recipient.

The subscribers to instant messaging are called **buddies**.

Most messenger servers allow you to create what are known as **buddy lists**. You can store the buddies you want to chat to in the buddy list.

The messenger server informs you as soon as one of your buddies comes online or goes offline. **Offline** means that the buddy has disconnected from the messenger server.

In addition to this, each buddy can determine their own (communication) **status** (**state of presence**, see page 73), from which buddies can tell whether they are in the mood to chat or wish to remain undisturbed.

The Web configurator on your phone gives you the following options:

- ◆ Go **online** (page 72).
- ◆ Display the list of your contacts (**buddies**) on the handset that you previously created on the PC. This will indicate for each buddy whether they are available (**online**) and ready to chat (**state of presence**, see page 73).

- ◆ Exchange messages with your buddies. Your handset notifies you about new messages with a flashing message key  and a beep.
- ◆ Call your buddies directly from your buddy list (page 77).

### Preconditions for instant messaging:

- ◆ You have registered with an instant messaging provider via the Web browser on your PC and (optionally) agreed a Web name (nickname).
- ◆ You have created a buddy list via the messenger client on the PC.
- ◆ You have saved the messenger server address and your access data for the messenger server (user ID, password) in the phone using the Web configurator (page 126). The phone needs the data to establish a connection with the messenger server.

### Please note:

If your instant messaging provider doesn't support the phone's messenger client, then you can open an account with an open Jabber server and use the Web configurator to enter its address in your phone. Many of these Jabber servers offer gateways to other messenger servers (e.g. AOL, ICQ, MSN, Yahoo!).

You can find a list of Jabber servers and an overview of the gateways to other messenger servers on the Internet at

<http://www.jabber.org>.

You can find information on setting up a Jabber account with connections from ICQ, MSN or Yahoo on the Internet, e.g. at:

<http://web.swissjabber.ch>



## Establishing a connection, going online

When you go online, your buddy list will be displayed on the handset and you will receive messages from your buddies.

Only one of the handsets connected to the base station can connect to the messenger server. You can then only "chat" on this handset.

An external call will interrupt the "chat", but you will still be online. You can continue your chat after you end or reject the call.

**Precondition:** You have saved the messenger server address and your access data for the messenger server (user ID and password) in the phone using the Web configurator (page 126).

 →  → Messenger

**Yes** Press the display key to confirm the prompt.

The phone attempts to establish a connection. You are informed about the status of the connection by messages on the display.

If the connection can be established, you are **Online**. The display will show the sub-menu for your messenger. You can open your buddy list, send and receive messages and call your buddies.

The following is displayed when the handset is in idle status.



You remain online until you set your status to **Offline** (page 73) or the connection to the messenger server is terminated (page 77).

You also remain online if you press the end call key .

If the connection cannot be established, you will receive an appropriate message. Please try again later (page 77).

### Please note:

You can also assign the messenger to one of the display keys on your handset (page 87). The connection is established when you press the display key.

## Lost connection

If your phone loses its connection to the messenger server, the display key  will flash on the handset that had been connected to the messenger. In idle status it will display "**Messenger connection failed!**". All messages that you had previously received, as well as any message you were currently writing, will be saved.

Reconnecting:

 Press the message key.

**Yes** Press the display key to confirm the prompt.

The phone will attempt to reconnect. You are informed about the status of the connection by messages on the display.

If you reply to the request with **No** the phone will behave as during regular disconnection. All messenger messages will be deleted. The phone is offline.

## Changing/checking your personal status, going offline

You want to log off (go offline) or let your buddies know whether you wish to chat or would prefer to remain undisturbed.

You have the following options:

### Offline

You log off from the messenger server. The messenger server informs your buddies that you are no longer available.

The handset switches to idle status. You can neither send nor receive messages.

### Online

(Setting after successful connection)  
You are logged on to the messenger server and can send and receive messages.

### Ready for chat

You are **Online** and can send and receive messages.

You invite your buddies to "chat" with you.

### Away / Extended Away / Do not disturb

You are **Online** and can send and receive messages. You inform your buddies that you currently cannot/do not wish to "chat", i.e. will not reply to their messages immediately.

### Invisible



You are **Online** and can send and receive messages.



However, the messenger server indicates to your buddies that you are **Offline**.

#### Please note:

All status settings apart from **Offline** only inform other buddies about your communication status. Whether this information is passed on to your buddies depends on the provider.

## Changing status

 →  → Messenger → User Status  
→ Change Status

 Select status and press **OK**  
( = on).

 Press **and hold** if necessary (idle status).

## Disconnecting, going offline

▶ Select **Offline** status, and respond **Yes** to the security prompt.

The connection to the messenger server will be terminated. The handset returns to idle status. New messenger messages are no longer sent to you. The messenger message list is deleted. The buddy list is no longer available.

#### Please note:

Whether messages directed to you are deleted or stored in the messenger server depends on the provider. Stored messages are sent to you when you go online again.

## Checking your status and user ID

 →  → Messenger → User Status  
→ Info

If you are online, the following information may be displayed (depending on your provider):

- ◆ Your Web name (nickname, abbreviated if necessary)
- ◆ Your current status
- ◆ Your user ID (format: userid@provider-domain; abbreviated if necessary)

Only **Offline** will be displayed if you are offline.

## Opening the buddy list

**Precondition:** You are **Online** and have already created a buddy list (using the PC) on your provider's messenger server.

→ → **Messenger** → **Buddies**

Only the first 20 (maximum) buddies on the buddy list will be read by the messenger server and displayed on the handset. The number depends on the available memory space.

The buddies that are displayed depend on which buddies were transferred from the messenger server first.

**Please note:**

You can also receive and respond to messages from buddies who are not on the list displayed on the handset.

Example:

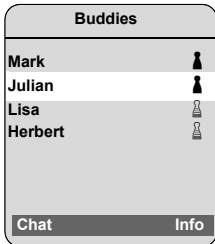

The Web names (nicknames) of your buddies are displayed on the list. If they do not have a Web name, the user ID is displayed.

If the name of a buddy is longer than one line, it will be abbreviated. You can navigate in the list with the control key .

The buddies appear on the list in the following order. Their status (page 73) is identifiable by the colour of the icon next to the buddies:

1. Buddies with **Online** status or **Ready for chat** in alphabetical order. The icon is **green**.
2. Buddies with **Away**, **Extended Away** or **Do not disturb** status in alphabetical order. The icon is **orange**.

3. Buddies with **Offline** or **Invisible** status in alphabetical order. The icon is **red**.

**Please note:**

The buddy list will remain open until you exit it (briefly press or press and hold ). The handset will not automatically return to idle status.

### Changes in the status of buddies

You have opened the buddy list and one of the buddies changes their status. The following distinctions are made:

- ◆ A buddy changes to status **Online** / **Ready for chat** :  
You are informed via a message on the display. The buddy list is updated.
- ◆ In the event of another status change, the buddy list is updated. No message is displayed.

**Please note:**

If the buddy changes to **Offline** status, your messages are no longer sent to them. Whether the messenger server stores the messages until the buddy is **Online** again or deletes them depends on the provider.

## Requesting information about buddies

You have opened the buddy list (page 74).

Select buddy.

**Info** Press the display key.

The display depends on the provider.

Example:

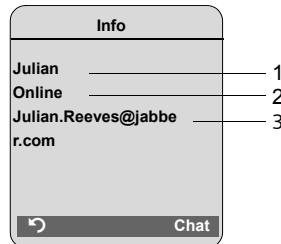

- 1 Web name (nickname, abbreviated if necessary)
- 2 Status
- 3 User ID (format: userid@provider-domain; abbreviated if necessary). (Resource names are not displayed)

If the buddy changes their status the entry is updated.

Press  to return to your buddy list. Press **Chat** if you want to "chat" with the buddy.

## Chatting to buddies

You want to "chat" to a buddy, i.e. send a message.

**Precondition:** You have opened the buddy list (page 74) and selected a buddy with .

- ▶ Press the display key **Chat**. The text editor is opened.
- ▶ Write and send your message (page 76).

The buddy list is shown again.

## Receiving messages

**Precondition:** You are online.

Newly arrived buddy or info messages (page 75) are indicated by a flashing message key  and a beep, even if you are in a messenger menu or text editor.

The messages are stored in the **Messenger:** message list.

### Please note:

The **Messenger** list is only displayed if you are online.

### Opening the message list using the key

The message key flashes.



- ▶ Press the message key .
- ▶ Select **Messenger: (2)** list if required and press **OK**. The number in brackets indicates the number of new messages.

### Please note:

If you are in the messenger menu or one of its submenus/text editors and you press the flashing message key , this will open the **Messenger** list directly.

### To open the message list from the menu:

In the handset idle status:

 →  → **Messenger** → **Messages**  
Select and press **OK**.

## Message list

The messages on the list are sorted chronologically, with the oldest message at the head of the list.

Example of a list display:

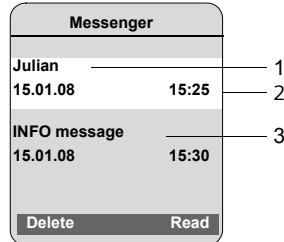

- 1 Sender's Web name/user ID  
**Bold:** new/unread message
- 2 Date and time of message
- 3 Message from the messenger server (page 75)

If the memory is full and new messages arrive, the oldest message(s) will be overwritten. If there are no old (read) messages, the oldest new (unread) messages will be overwritten.

## Message types

In instant messaging, a distinction is made between the following types of message:

- ◆ **Buddy messages** are the "instant messages" you receive from other buddies. You can answer the messages.
- ◆ **Info messages** are special information from the provider. They are forwarded to you, but you cannot reply to them.

**Example:** With some messaging providers you receive an info message when another subscriber tries to add you to their buddy list. You are prompted to check the messages on the messenger client on your PC.

## Messenger

Via the messenger client on your PC you can agree to the action or refuse permission. Without your agreement, the other subscriber cannot add you to their buddy list.

### Reading messages

**Precondition:** You have opened the message list and selected a message with .

- ▶ Press the display key **Read**.

The message is opened for you to read.

You have the following options:

**Delete** Delete a message from the list. You will return to the message list.

Or:

**Answer** (for buddy messages only)  
Reply to message. The text editor is opened. You can write a reply (see "Writing and sending messages" on page 76).

Or:

 Back to the message list.

### Delete message

**Precondition:** You have opened the message list and selected a message with .

- ▶ Press the display key **Delete**.

## Writing and sending messages

**Precondition:**

- ◆ You are reading a buddy's message and press the display key **Answer** or
- ◆ You have pressed the display key **Chat** in the buddy list or the buddy profiles.

A text editor is opened.

- ▶ Use the handset keys to enter a message (max. 612 characters).
- ▶ Select  → **Send** and press **OK**.

The message is sent to the buddy.

### Please note:

- Entering text with and without EATONI predictive text is described from page 148.
- EATONI is activated as a default setting. How to activate/deactivate EATONI, see page 149.

If the messenger server is unable to send the message to the buddy, a message will be displayed.

- ▶ Confirm the message by clicking **OK**.

The text-editor will re-open with your message. You can then retry sending the message.

### Interruption while writing

If you receive a call/SMS while you are writing a message or the connection to the messenger server is interrupted, the text editor is terminated and the text written so far is lost.

### Menu options for the text editor

By pressing  within the text editor you have the following options:

**Send**

Send message to buddy.

**Delete Text**

Delete the whole text.

**Predictive Text**

Activate/deactivate predictive text see page 148.

**Select Language**

For predictive text: select the language in which you wish to write the text and press **OK**.

## Calling a buddy



---

You can call a buddy directly.

**Precondition:** The messenger server supports calls using vCard and your buddy's vCard contains a phone number.

### Preconditions:

- ◆ You have opened the buddy list and selected a buddy  
or
- ◆ You have opened the buddy's profile  
or
- ◆ You have opened the **Messenger:** list and selected a buddy  
or
- ◆ You are reading a message from a buddy

 /  **Briefly press** or **press and hold** the talk or handsfree key.

The phone will try to establish a VoIP/fixed line connection.

The first number that is found on the vCard will be dialled.

### Ending a call

 Press the end call key.

## Self-help with errors

---

While establishing a connection to the messenger server, during connection and when sending messages the following errors may occur.

### Behaviour when the connection is lost

If the connection to the messenger server is interrupted, an appropriate message is shown in the display. You are **Offline** .

If you are in a submenu of the messenger, the handset switches to the messenger menu.

- ▶ Try to re-establish the connection (page 72).

## Errors when sending

---

If it is not possible to send a message, a distinction is made between the following situations:

- ◆ The connection to the messenger server is interrupted:  
A message is shown in the display to indicate that the connection to the messenger server has been interrupted.  
The message is stored temporarily (page 76).
  - ▶ Try to re-establish the connection (page 72) and send the message again.
- ◆ The server is unable to send the message:  
A message is shown in the display to indicate that the message could not be sent. If, for example, the buddy is not available, the message you have sent will also be displayed.  
The message is stored temporarily (page 76).
  - ▶ If necessary, check the buddy's user ID and send the message again later.

## Using the network mailbox

---

Some fixed line network providers and VoIP providers offer answer machines on the network – these are known as network mailboxes.

Each network mailbox accepts incoming calls made via the corresponding line (fixed line network or corresponding VoIP phone number). To record all calls, you should therefore set up network mailboxes for both the fixed line network and for each of your VoIP connections.

You need to have **requested** the network mailbox for your fixed line network connection from your fixed line network provider. You can store the phone number for the fixed line network mailbox in the base station.

You can activate/deactivate the network mailboxes for your VoIP connections using your handset or the Web configurator. To do this, you only require the network mailbox phone number.

### Activating/deactivating the network mailbox, entering numbers

---

You can manage the network mailboxes on your handset that are assigned to a receive number on the handset.

 →  **Settings** → **Voice Mail**  
→ **Network AM(s)**

The list of connections (VoIP and fixed line network) that are assigned to the handset as receive numbers is displayed. The display shows **Net AM: xxx**, where xxx is replaced by the relevant default name for the connection (**IP1 to IP6, Fxd. line**).

 Select connection and press **OK**.

### You have selected a VoIP connection:

▶ Change multiple line input:

#### Status

Select **On** to activate the network mailbox. Select **Off** to deactivate.

#### Number

The number that is currently stored for the network mailbox is displayed.

Enter or change the phone number for the network mailbox if necessary.

With some VoIP providers your network mailbox phone number will be downloaded together with the general VoIP provider data (page 112), saved to your base station and displayed under

**Number**.

### You have selected the fixed line network connection:

#### Number

Enter or change the phone number for the network mailbox.

You cannot activate/deactivate the network mailbox for the fixed line network connection via the handset. For how to activate/deactivate the network mailbox for the fixed line network connection please refer to the fixed line network provider's information.

#### Please note:

For information on how to activate and deactivate network mailboxes via the Web configurator and to change their assigned numbers, see, see page 126.



## Configuring the (network) mailbox for fast access

You can use fast access to make direct calls to a network mailbox or, for the Gigaset S675/S685 IP, also the integrated answer machine on the base station.

### Assigning key 1 of the handset, changing assignments

The setting for fast access is handset-specific. You can assign a different answer machine to key  on each registered handset.

No answer machine is preconfigured for fast access in the default settings.



 Fast access is not yet set on the handset: Press and hold key .

Or:

 →  **Settings** → **Voice Mail**  
→ **Set Key 1**

The list of connections (VoIP and fixed line network) that are assigned to the handset as receive numbers is displayed. The display shows **Net AM: xxx**, where xxx is replaced by the relevant default name for the connection (IP1 to IP6, Fxd. line ).

Gigaset S675/S685 IP: For the integrated answer machine of the base station, the entry **Local AM** is offered in the list (see page 66).

 Select entry and press **OK**  
( = on).

When selecting a network mailbox:

If a number is already saved to the base station for the network mailbox, fast access is activated.

 Press and **hold** (idle status).

If no number has been saved for the network mailbox, a message is displayed to this effect.

You will be prompted to enter the number for the network mailbox.



Jump to the **Number** line.



Enter the number for the network mailbox.



Press the display key.



Press and **hold** (idle status).

Fast access is automatically activated.

#### Please note:

You can only assign fast access to **one** answer machine.

However, you can also call the network mailbox assigned to a handset's receive numbers directly via the message key (page 80).

## Calling the network mailbox

 Press and **hold**.

If you have set a network mailbox for fast access you will be connected straight to this network mailbox.



If necessary, press the hands-free key.

You hear the network mailbox announcement.

Gigaset S675/S685 IP: If you have set the integrated answer machine on the base station for fast access, message playback begins (see page 66).



## Listening to messages on the network mailbox

Under the message key  you will find a list for each network mailbox that fulfils the following requirements:

- ◆ The corresponding connections are allocated to the handset as receive numbers.
- ◆ The network mailbox phone number is saved on the base station.

You can call and check the network mailbox directly from the list.

When you press the message key , the following is displayed (example):

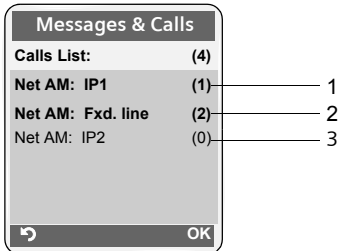

- 1 "Fxd. line ", "IP1" etc. are the default names for the associated connections. The default names are always shown irrespective of which connection name you have specified when configuring via the Web configurator.
- 2 If there are new messages in the network mailbox, the list entry is shown in bold. The number of new messages is shown in brackets following the list entry.
- 3 If there are no new messages (0) is shown after the list entry for the network mailbox. The number of messages stored in the network mailbox is not displayed.

## Displaying new messages in the handset's idle status

If a new message is present on one of the network mailboxes to which the handset is allocated via its receive number, or there is a new message on the integrated answer machine, the ∞ icon and the number of new messages are shown on the handset's idle display. The  message key flashes.

## Calling the network mailbox and checking messages

 Press the message key.

**Net AM:** Fxd. line / **Net AM:** IP1 / etc.

Select the network mailbox and press **OK**.

You are connected directly to the network mailbox and hear its announcement. Messages can generally be played back using your handset keypad (digit codes). Listen to the announcement.

### Please note:

- The network mailbox is automatically called via the corresponding connection. An area code predefined for your phone is **not** prefixed.
- Network mailbox messages can generally be played back using your handset keypad (digit codes). You need to define how the digit codes for VoIP should be converted to DTMF signals and transmitted (page 122). Ask your VoIP provider which type of DTMF transmission it supports.

## Using several handsets

### Registering handsets

You can register up to six handsets to your base station.

You can register your Gigaset S67H/S68H handset on up to four base stations.

When you register a new Gigaset handset, the base station transfers the following entries to its local directory to enable you to use online directories on your new handset:

- ◆ **Net Directory** for the currently active online directory (page 129)
- ◆ **Yellow Pages** for the currently active classified directory (page 129)
- ◆ **Gigaset.net** for the Gigaset.net directory

**Precondition:** The handset can send and receive directory entries (see handset operating instructions).

Successful registration is acknowledged with a **Data Transfer x entries received** for this reason.

#### Please note:



- If a number of handsets are registered on your base station, you can simultaneously make two calls via the Internet and one via the fixed line network. Up to two additional internal connections are also possible.
- Selecting the connection via the talk key (page 26) is not supported on GAP handsets. Therefore, if you enter a number without a line suffix and without defining a dialling plan for the phone number, it will be dialled via **Default Line** (page 98). If you enter a "\*" (star) at the end of the phone number, it will be dialled via the non-default connection.
- After registration, all the phone numbers for the phone will be assigned to the handset as receive numbers. It will use the fixed line network number and the first VoIP number as send numbers. For how to change the assignments, see page 120.

### Registering another Gigaset S67H/S68H handset on the Gigaset S685/S675 IP

Before you can use your handset, you must register it to a base station.

You must initiate handset registration on the handset and on the base station.

If the handset has been registered successfully, the handset returns to idle status. The handset's internal number is shown in the display e.g. **Int 1**. If not, repeat the procedure. Registration can take up to one minute.

- ▶ **Select**  →  → **Handset**  
→ **Register H/Set** on the handset.
- ▶ Enter the system PIN of the base station (the default is 0000) and press **OK**. The display shows e.g. **Base 1** and flashes.
- ▶ Within the next 60 seconds, press and **hold** (for approx. 3 seconds) the registration/paging key (page 2) **on the base station**.

The handset is given the lowest available internal number (1–6). If a number of handsets are registered on the base station, the internal number appears in the display after registration, e.g. **INT 2**. This means that the internal number 2 was assigned to the handset.

#### Please note:

- If six handsets are already registered to the base station, there are two options:
- The handset with the internal number 6 is in idle status: the handset you wish to register is assigned the number 6. The handset that was previously number 6 is de-registered.
  - The handset with the internal number 6 is being used: the handset you wish to register cannot be registered.

## Registering other handsets on the Gigaset S685/S675 IP

---

You can register other Gigaset handsets and handsets for other devices with GAP functionality as follows.

- ▶ Begin the registration procedure **on the handset** in accordance with the handset's operating instructions.
- ▶ Press and hold (for approx. 3 seconds) the registration/paging key (page 2) **on the base station**.



### Please note:

You can also make changes on your base station with a Gigaset S45 and C47H handset.

## De-registering handsets

---

You can de-register any registered handset from any registered Gigaset S67H/S68H handset.

-  Open list of internal parties. The handset you are currently using is highlighted with <.
-  Select the handset to be de-registered.

**Options** Press the display key.

**De-reg. H/Set No.**  
Select and press **OK**.

 Enter the base station system PIN (default setting: 0000).

**Yes** Press the display key to confirm the prompt.

 Press and **hold** (idle status).

The handset is de-registered immediately, even if it is not in idle status.

## Locating a handset ("paging")

---

You can locate your handset using the base station.

- ▶ **Briefly** press the registration/paging key on the base station (page 2).
- ▶ All handsets will ring at the same time ("paging"), even if ringer tones are switched off.

The current (local) IP address for the base station appears in the handset displays.

### Ending paging

- ▶ **Briefly** press the registration/paging key on the base station (page 2).

Or

- ▶ Press the talk key  or the end call key  on a handset.

## Changing the base station

---

If your handset is registered to more than one base station, you can set it to a particular base station or to the base station that has the best reception (**Best Base**).

 →  → **Handset** → **Select Base**

 Select one of the registered base stations or **Best Base** and press **OK**.

## Changing a handset's internal number

---

A handset is **automatically** assigned the lowest free number on registration. In the list of internal parties, the handsets are sorted according to their internal number.

You can change the internal number of all registered handsets (1-6). Numbers 1-6 can only be assigned once each.

 Open list of handsets. Your own handset is indicated by <.

**Options** Press the display key.

**Edit H/Set No.**

Select and press **OK**. The list of handsets and their internal numbers will be displayed. The internal number for the first handset flashes.



Select handset.



Enter the new internal number (1-6). The handset's old number is overwritten.



If necessary, select further handsets and change numbers.

After all the changes are completed:

**Save** Press the display key to save the input.



Press and **hold** (idle status).

You will hear the error tone if an internal number has been allocated twice.

- ▶ Repeat the procedure with a free number.

**Changing the name of a handset**

The names "INT 1", "INT 2" etc. are assigned automatically at registration. You can change these names. The changed name is displayed in every handset's list.



Open list of handsets. Your own handset is indicated by <.



Select handset.

**Edit**

Press the display key.

**<C**

Delete previous name if necessary.



Enter the new name (max. 10 characters).

**Save**

Press the display key.



Press and **hold** (idle status).

**Please note:**

If you delete the current handset name and then press **Save** without entering a new name, the handset will automatically be allocated the standard name "INT x" (x= internal number).

**Making internal calls**

Internal calls to other handsets registered on the same base station are free.

They will always be made via broadband if both handsets are broadband-capable.

**Calling a specific handset**

Initiate internal call.



Enter the number of the handset.

Or:



Initiate internal call.



Select handset.



Press the talk key.

**Calling all handsets ("group call")**

Initiate internal call.



Press the star key. All handsets are called.

**Ending a call**

Press the end call key.

**Please note:**

You can reject an internal call by pressing the end call key .

Other handsets will continue to signal an internal "group call".

**Transferring a call to another handset**

You can forward (connect) an external call, made via fixed line network or VoIP, to another handset.



Open the list of handsets. The external participant hears hold music if activated (page 97).



Select handset or **Call All** and press **OK**.

When the internal participant answers:

- ▶ If necessary announce the external call.



Press the end call key.

The external call is transferred to the other handset.

## Using several handsets

If the internal participant does **not** answer or the line is busy, press the display key **End** to return to the external call.

When transferring a call you can also press the end call key  before the internal participant answers.

Then, if the internal participant does not answer or the line is busy, the call will automatically return to you (the display will show Recall).

## Initiating internal consultation call, conference call

---

You are talking to an **external** participant (via fixed line network or VoIP) and can call an **internal** participant at the same time to hold a consultation call.

 Open the list of handsets. The external participant hears hold music if activated (page 97).

 Select handset and press **OK**.

When an internal participant answers you can speak to them.

You have the following options:

### Ending a consultation call



**End** Press the display key.

You are reconnected with the external participant.

### Initiating a conference call

**Conf.** Press the display key.

You are in a three-way conference call with the external participant and the internal participant.

If the internal participant who has been called ends the call (press end call key ) , you will be connected with the external participant. If you press end call key , the external call will be transferred to the internal participant.

## Accepting/rejecting call waiting during an internal call

---

If you receive an **external** call during an **internal** call, you will hear the call waiting tone (short tone). With Calling Line Identification, the caller's number will appear in the display.

### Ending an internal call, accepting an external call

**Accept** Press the display key.

The internal call is **ended**. You are connected to the external caller.

### Rejecting the external call

**Reject** Press the display key.

The call waiting tone is turned off. You remain connected with the internal participant. The ringer tone can still be heard on other registered handsets.

## Using a handset as a room monitor

---

If the room monitor is activated, a previously stored destination number is called as soon as a set noise level is reached in the room.

You can save an internal or external number in your handset as the destination number.

The room monitor call to an external number stops after around 90 seconds. The room monitor call to an internal number (handset) stops after approx. 3 minutes (depending on the base station). During use as a room monitor, all keys are barred except for the end call key . The speaker of the handset is muted.

When the room monitor is activated, incoming calls to the handset are indicated **without a ringer tone** and are only shown on the screen. The display and keypad are not illuminated and advisory tones are also turned off.

If you accept an incoming call, the room monitor is suspended for the duration of the call, but the function **remains** activated.

If you deactivate then re-activate the handset, the room monitor remains activated.

### Warning!

- You should always check the operation of the room monitor before use. For example, test its sensitivity. Check the connection if you are diverting the room monitor to an outside number.
- When the function is switched on, the handset's operating time is considerably reduced. If necessary, place the handset in the charging cradle. This ensures that the batteries do not run down.
- Ideally the handset should be positioned 1 to 2 metres away from the baby. The microphone must be directed towards the baby.
- The connection to which the room monitor is forwarded must not be blocked by an activated answer machine.

## Activating the room monitor and entering the number to be called

 →  → Room Monitor

- ▶ Change multiple line input:

Room M.:

Select **On** to activate.

Call to:

**External number:**

- ▶ Select the number from the directory (press display key ) or enter it directly. Only **the last 4 characters** are displayed.

**Internal number:**

- ▶ Press the display key **Options**. Select **INT** and press **OK**.
- ▶ Use  to select the handset or **Call All** (if all registered handsets are to be called) and press **OK**.

Level:

Set noise level sensitivity (**Low** or **High**).

- ▶ Save changes (page 147).

The function is now activated.

You can use the **Options** display key to switch directly to the baby alarm settings.

### Please note:

If you do not specify a line suffix (page 27) and you do not define any dialling plans for the number (page 124), an external number will be dialled via the set standard connection (VoIP or fixed line network).

## Changing the set destination number

 →  → Room Monitor

 Scroll to the **Call to:** line.

 or **Delete**

Delete existing number.

- ▶ Enter number as described in "Activating the room monitor and entering the number to be called" (page 85).

## Deactivating the room monitor remotely

**Precondition:** The room monitor call is sent to an external destination number. The telephone called supports touch tone dialling.

- ▶ Accept the call from the room monitor and press keys  .

Your base station sends a confirmation tone and ends the connection.

### Please note:

External deactivating via VoIP connections is possible as long as the DTMF signals are transmitted (depending on the provider) either as SIP info messages, audible signals in the voice channel (inband or audio) or as special RTP data packets (pursuant to RFC2833).

The room monitor function is deactivated on the handset. There will be no further room monitor calls. The other room monitor settings (e.g. no ringer tone) on the handset will remain activated until you press the display key **OFF** on the handset.

To re-activate the room function with the same phone number:

- ▶ Turn on the activation again and save with **Save** (page 85).

## Handset settings

---

Your handset is preconfigured, but you can change the settings to suit your individual requirements.

### Changing the display language

---

You can view the display texts in different languages.





 →  → **Handset** → **Language**

The current language is indicated by .

 Select a language and press **OK**.

 Press and **hold** (idle status).

If you accidentally choose a language you do not understand:



     
Press keys in sequence.

 Select the correct language and press **OK**.

### Setting the display



---

You have a choice of four colour schemes and several different contrasts.

 →  → **Display**

**Colour Scheme**

Select and press **OK**.

 Select a colour scheme and press **OK** ( = current colour).

 Press **briefly**.

 Scroll to the **Contrast** line.

**Contrast** Select and press **OK**.

 Select contrast.

**Save** Press the display key.

 Press and **hold** (idle status).

### Setting the screensaver

---

You can set a picture from the Resource Dir. (page 90) to be displayed as a screensaver when the handset is in idle status. This will replace the idle status display. It may conceal the date, time and name.

The screensaver is not displayed in certain situations, e.g. during a call or if the handset is de-registered.

If a screensaver is activated, the **Screen Saver** menu option is marked with .

 →  → **Display** → **Screen Saver**

The current setting is displayed.

▶ Change multiple line input:

**Activation:**

Select **On** (screensaver is displayed) or **Off** (no screensaver).

**Selection:**

If required, change the screensaver (see below).

▶ Save changes: (page 147).

If the screensaver conceals the display, **briefly** press  to show the idle display with time and date.

### Changing the screensaver

---

 →  → **Display** → **Screen Saver**

 Scroll to the **Selection** line.

**View** Press the display key. The active screensaver is displayed.

 Select screensaver and press **Change**.

▶ Save changes: (page 147).

## Setting the display backlight

Depending on whether or not the handset is in the charging cradle you can set different levels of display illumination. If it is activated, the display is permanently dimmed.

 →  → **Display** → **Backlight**

The current setting is displayed.

▶ Change multiple line input:

### In Charger

Select **On** or **Off**.

### Without Charger

Select **On** or **Off**.



**Save** Press the display key.

 Press and **hold** (idle status).

### Please note:

The handset's standby time can be significantly reduced if the display backlight (On) is activated.

## Shortcuts for functions and numbers

You can assign the left display key and each of the digit keys  and  to  a number or a function. The right display key has a function pre-selected by default. You can change the function assigned.

The number is then dialled or the function started by simply pressing a key.

### Assigning a digit key/left display key

**Precondition:** The digit key or the left display key has not yet been assigned a number or a function.

▶ Press the  display key or press and **hold** the digit key.

The list of possible key assignments is opened (see below).

▶ Select the function with the control key  and press **OK**. The handset returns to idle status.

The following features are available:

### Quick Dial / Call-by-Call

Assign key to a number from the directory or call-by-call list.

The directory or call-by-call list is opened.

▶ Select an entry and press **OK**.

If you delete or edit an entry in the directory or call-by-call list, this has no effect on the assignment to the digit/ display key.

### Please note:

A number from the directory with a hash (#) at the end will be dialled via the standard connection, otherwise it is always dialled via the non-standard connection (page 98).

### ◆ INT (INT)

Opens the list of internal participants.

### ◆ SMS (SMS)

Opens the SMS submenu for writing, sending and reading SMS messages (page 54):

 → **SMS**

### ◆ Room Monitor (Room M.)

Assign menu for setting and activating the room monitor to a key (page 85).

### ◆ Alarm Clock (Alarm)

Assign menu for setting and activating the alarm clock to a key (page 91).

### ◆ Calendar (Calendar)

Opens the calendar to enter new or view saved appointments: 

### ◆ Withhold No. (Withhold)

If you press the display key **Withhold**, your phone number will not be transmitted for the next call and will therefore not appear in the recipient's display.

If you press the display key **Withhold**, a number editor will be opened.

Enter the phone number and press the display key **Send**.



## Handset settings

The number is always dialled via the fixed line network. This function does not support dialling with a line suffix.

### ◆ Bluetooth (Bluetooth)

Assign the Bluetooth menu to a key:

 →  → Data Transfer → Bluetooth

### ◆ E-mail (EMail)

Opens the e-mail submenu for receiving and reading e-mail notifications (page 68):

 → E-mail

### ◆ Messenger (Messgr.)

Opens the Messenger submenu for chatting with friends on the Internet (page 71):

 → Messenger

### ◆ Fixed Line Call (FixedLine)

Opens the pre-dialling option for making a call via the fixed line network.

### ◆ IP Call (IP)

Opens the pre-dialling option for making a call via VoIP.

If the display keys have been assigned a shortcut, the selected function or name of the phone number in the directory or call-by-call list is displayed (abbreviated if necessary) in the bottom display line via the relevant display key.

## Starting the function, dialling the number

If the handset is in idle status, press and **hold** the digit key or press the display key **briefly**.

Depending on the key assignment:

- ◆ Numbers are dialled directly.
- ◆ The function menu is opened.

## Changing key assignments

### Display key

- ▶ Press and **hold** the left or right display key.

The list of possible key assignments is opened.

- ▶ Proceed as is described when first assigning the key with a shortcut (page 87).

### Digit key



- ▶ Press the digit key **briefly**.

**Change** Press the display key. The list of possible key assignments is displayed.

- ▶ Proceed as is described when first assigning the key with a shortcut (page 87).

## Activating/deactivating auto answer

If you activate this function, when you receive a call you can simply lift the handset out of the charging cradle without having to press the talk key .

 →  → Handset

### Auto Answer

Select and press **OK** ( = on).



Press and **hold** (idle status).

## Changing the handsfree/earpiece volume

You can set the loudspeaker volume for handsfree talking to five different levels and the earpiece volume to three different levels.

In the handset idle status:



Press the control key at the top.

### Handset Volume

Select and press **OK**.



Set the earpiece volume.



Scroll to the **Handsfree Volume** line.



Set the handsfree volume.

**Save** Press display key if necessary to save the setting permanently.

Setting the volume during a call:

 Press the control key.

 Select volume.

**Save** Press display key if necessary to save the setting permanently.

The setting is automatically saved after approx. 3 seconds.

If  is assigned with another function, e.g. toggling (page 38):

**Options** Open menu.

**Volume** Select and press **OK**.

Configure setting (see above).

#### Please note:

You can also adjust the call volume via the menu  → **Audio Settings** → **Handset Volume**.

## Changing ringer tones

### ◆ Volume:

You can choose between five volumes (1–5; e.g. volume 2 = ) and the "crescendo" ring (6; volume increases with each ring =

.

### ◆ Ringer tones:

You can select various ringer tones, melodies or any sound from My stuff (page 90).

You can set different ringer tones for the following functions:

- ◆ **Ext. Calls:** for external calls
- ◆ **Internal Calls:** for internal calls
- ◆ **Appointments:** for set appointments (page 92)
- ◆ **All:** the same ringer tone for all functions

## Settings for individual functions

Set the volume and melody depending on the type of signalling required.

In the handset idle status:

 Press the control key at the top.

### Ringer Settings

Select and press **OK**.

### Ext. Calls / Internal Calls / Appointments

Select and press **OK**.

► Change multiple line input:

 Set volume (1–6).

 Scroll to the next line.

 Select melody.

**Save** Press the display key to save the setting.

## Same ringer tone for all functions

In the handset idle status:

 → **Ringer Settings** → **All**

► Set volume and ringer tone (see "Settings for individual functions").

**Save** Press the display key to confirm the prompt.

 Press and **hold** (idle status).

#### Please note:

You can also adjust the ringer tones via the menu  → **Audio Settings** → **Ringer Settings**.

## Activating/deactivating the ringer tone

You can deactivate the ringer tone on your handset before you answer a call or when the handset is in idle status; the ringer tone can be deactivated permanently or just for the current call. The ringer tone cannot be re-activated while an external call is in progress.

### Deactivating the ringer tone permanently

 Press and **hold** the star key.

The  icon appears in the display.

## Handset settings

### Re-activating the ringer tone



Press and **hold** the star key.

### Deactivating the ringer tone for the current call



Press the display key.

### Activating/deactivating the alert tone

In place of the ringer tone you can activate an alert tone. When you receive a call, you will hear a **short tone** ("Beep") instead of the ringer tone.



Press and **hold** the star key and **within 3 seconds**:



Press the display key. A call will now be signalled by **one** short alert tone. appears in the display.

## Activating/deactivating advisory tones

Your handset uses "advisory tones" to tell you about different activities and statuses. The following advisory tones can be activated/deactivated independently of each other:

- ◆ **Key click**: every key press is confirmed.
- ◆ **Advisory Tones**:
  - **Confirmation tone** (ascending tone sequence): at the end of an entry/setting and when an SMS or a new entry arrives in the calls list or in the answer machine list
  - **Error tone** (descending tone sequence): when you make an incorrect entry
  - **Menu end tone**: when scrolling at the end of a menu
- ◆ **Battery tone**: the batteries need to be charged.

In the handset idle status:



Press the control key at the top.

### Advisory Tones

Select and press **OK**.

- ▶ Change multiple line input:

### Key Tones:

Select **On** or **Off**.

### Confirm.:

Select **On** or **Off**.

### Battery:

Select **On**, **Off** or **In Call**. The battery warning tone is only activated/deactivated and only sounds during a call.

- ▶ Save changes (page 147).

You cannot deactivate the confirmation tone for placing the handset in the charging cradle.

### Please note:

You can also adjust the ringer tones via the menu → **Audio Settings** → **Advisory Tones**.

## My stuff

My stuff on the handset manages sounds, which you can use as ringer tones, and pictures (CLIP pictures and screensavers), which you can use as caller pictures or as screensavers. Precondition: Calling Line Identification (CLIP).

My stuff can manage the following media types:

Icon	Sound	Format
	Ringer tones	Standard
	Monophonic	Standard
	Polyphonic	.mid
	Picture: CLIP picture	BMP 128 x 100 px Or
	Screensaver	128 x 160 px (px = Pixel)

The icon is displayed in front of the name in My stuff. Various mono- and polyphonic sounds and pictures are preconfigured on your handset.

You can listen to the available sounds and view the pictures. You can download your own pictures from a PC to the Gigaset S68H handset using Bluetooth connections and save them in My stuff (page 149).

The pre-configured pictures are labelled with . You cannot rename or delete them.

## Playing back sounds/viewing CLIP pictures

 →  → Screensavers / Caller Pictures / Sounds (select entry)

**Play / View** Press the display key. Sounds are played back or pictures are displayed. Press the  key to switch between entries.

**End /**  Press the display key. Playback of the sound or display of the picture ends.

While you are playing back sounds, you can also interrupt playback with the  key.

 Press and **hold** (idle status).

If you have saved a picture in an invalid data format, you will see an error message after selecting the entry. Cancel the operation with . Delete the picture with **Delete**.

## Sounds: Setting the volume

During playback:

**Volume** Press the display key.

 Set volume.

**Save** Press the display key.

## Renaming/deleting a picture

You have selected an entry.

**Options** Open menu.

If a picture cannot be deleted () , these options are not available. Depending on the situation, you can select the following functions:

### Delete Entry

The selected entry is deleted.

### Delete List



All entries in the list that can be deleted are deleted.

### Rename

Change the name (max. 16 characters) and press **Save**. The entry is stored with the new name.

## Gigaset S68H: Checking the memory

You can check how much memory is available for screensavers and CLIP pictures.



 →  → Capacity

 Back: Press the display key.

## Setting the alarm clock

**Precondition:** The date and time have already been set (page 11).

## Activating/deactivating the alarm clock and setting the wake-up time

 → 

▶ Change multiple line input:

**Activation:**

Select **On** or **Off**.

**Time:**

Enter the wake-up time in 4-digit format.

**Occurance:**

Select **Daily** or **Monday-Friday**.

**Volume:**

Set loudspeaker (1–6).

## Handset settings

### Melody:

Select melody.

- ▶ Save changes (page 147).

You will see the  icon.

A wake-up call with the selected ringer tone is signalled on the handset. The wake-up call sounds for 60 seconds.  is shown in the display. If no key is pressed, the wake-up call is repeated twice at five minute intervals and then turned off.

During a call, the wake-up call is signalled by a short tone.

### Deactivating the wake-up call/ repeating after a pause (snooze mode)

**Precondition:** A wake-up call is sounding.

**OFF** Press the display key. The wake-up call is deactivated.

Or

**Snooze** Press the display key or any key. The wake-up call is deactivated and then repeated after 5 minutes. After the second repetition the wake-up call is deactivated completely.



## Setting an appointment (calendar)



You can have your handset remind you of up to 30 appointments (volume and melody, see page 89).

### Saving an appointment

If you have already saved 30 appointments, you must first delete an existing appointment.

**Precondition:** The date and time have already been set (page 11).

 →  Open the graphical calendar. Days on which appointments have already been saved are highlighted in black.

 /  Select day and press **OK**.

If appointments have already been saved for the day, the list of appointments will be displayed: select **<New Entry>** and press **OK**.

- ▶ Change multiple line input:

### Appoint.:

Select **On** or **Off**.

### Date:

Enter day/month/year in 8-digit format.

### Time:

Enter hours/minutes in 4-digit format.

### Notes:

Enter text (max. of 16 characters). The text appears as the appointment name in the list and will be displayed on the screen during the appointment reminder. If you do not enter any text, only the date and time of the appointment are displayed.

**Save** Press the display key.

 Press and **hold** (idle status).



The appointment is marked with  in the appointments list. The list of appointments is sorted by date.

An appointment reminder is signalled with the selected ringer tone (page 89). The appointment reminder sounds for 60 seconds. The entered text, date and time are displayed.

During a call, the appointment reminder is signalled by a short tone.

## Managing appointments

 → 

 /  Select the day in the graphical calendar and press **OK** or . Days on which appointments have already been saved are highlighted in black in the calendar.

 Select appointment for the day.

**Options** Open menu  
Back with .

You have the following options:

#### View Entry

View selected appointment.  
Open the **Options** menu for editing, deleting and activating/deactivating.

#### Edit Entry

Edit selected appointment.

#### Delete Entry

Delete selected appointment.

#### Activate / Deactivate

Activate/deactivate the selected appointment.

#### Delete List

Delete **all** appointments.

## Deactivating or accepting an appointment reminder

---

**Precondition:** An appointment reminder is sounding.

- ▶ Press the display key **OFF** to switch off the appointment reminder.

Or:

- ▶ Press the display key **SMS** to write an SMS.

## Displaying missed appointments and anniversaries

---

Missed appointments/anniversaries (page 45) are displayed in the **Missed Alarms** list if:

- ◆ You do not accept an appointment/anniversary.
- ◆ The appointment/anniversary was signalled during a phone call.
- ◆ The handset is deactivated at the time of the appointment/anniversary.
- ◆ Automatic redial was activated at the time of an appointment/anniversary (page 48).

The most recent entry is at the head of the list.

If there is a new appointment/anniversary in the list, the display shows **Appoint.**. Pressing the display key will also open the **Missed Alarms** list.

To open the list from the menu:



→ **Missed Alarms**

Select appointment/anniversary.

Information about the appointment/anniversary is displayed. A missed appointment is displayed with the appointment name and a missed anniversary is displayed with the last name and first name. The date and time will also be given.

**Delete**

Delete appointment.

**SMS**

Write an SMS



Press and **hold** (idle status).

If 10 entries are already stored in the list, the next appointment reminder will delete the oldest entry.

## Gigaset S68H handset: using Bluetooth devices

---

Your Gigaset S68H handset can communicate wirelessly via Bluetooth™ with other devices using this technology.

Before you can use your Bluetooth devices, you must first activate Bluetooth and then register the devices to the handset.

You can register 1 Bluetooth headset to the handset. You can also register up to 5 data devices (PC, PDA) to send and receive directory entries as vCards or exchange data with the computer (page 147).

In order to transfer phone numbers via Bluetooth, it is essential that area codes (international and local area codes) are saved on the phone (see page 95).

You will find a description of how to operate your Bluetooth devices in the user guides for these devices.

## Handset settings

### Please note:

- You can only operate headsets on your handset that have the **headset profile**.
- It can take up to 5 seconds to create a connection between your handset and a Bluetooth headset. This applies both when a call is accepted using the headset or transferred to the headset, and when a number is dialled from the handset.

## Activating/deactivating Bluetooth mode

 → **Activation**

Press **OK** to activate or deactivate Bluetooth mode ( = activated).

In idle status, the  icon on the handset shows that Bluetooth mode is activated:

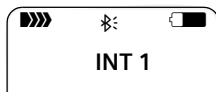

## Registering Bluetooth devices

The distance between the handset in Bluetooth mode and the activated Bluetooth device (headset or data device) should be no more than 10 m.

### Please note:

- If you register a headset, any headset that is already registered will be overwritten.
- If you register a headset to your handset that is already registered to another device (e.g. to a mobile phone), the existing registration data may be overwritten by the new registration.  
If you would like to operate a headset on both the mobile phone and on your handset, you should use a headset that supports several terminals.

 → **Search Headset / Search Data Device**

The search can take up to 30 seconds.

Once the device has been found, its name will be shown on the display.

**Options** Press the display key.

**Trust Device** Select and press **OK**.



Enter the PIN for the Bluetooth device you want to **register** and press **OK**.

The device is saved in the list of known devices.

## Cancelling/repeating current search

To cancel search:

**Cancel** Press the display key.

Repeat search if necessary:

**Options** Select and press **OK**.

**Repeat Search**



Select and press **OK**.

## Editing the list of known (trusted) devices

### Open list

 → **Known Devices**

A corresponding icon appears next to each device name in the list displayed:

Icon	Meaning
	Bluetooth headset
	Bluetooth data device

### Viewing entries

Open list →  (select entry)

**Options** Press the display key.

**View Entry** Select and press **OK**.  
Device name and address are displayed.  
Back with **OK**.

### De-registering Bluetooth devices

Open list →  (select entry)

**Options** Press the display key.

**Delete Entry** Select and press **OK**.



Back: Press and **hold** key.

**Please note:**

If you are using a headset and you complete the registration process by entering the PIN, the headset is saved in the device list as a data device and not as a headset. Therefore, initiate a new registration by searching for a headset.

**Changing the name of a Bluetooth device**

Open list →  (select entry)

**Options** Press the display key.

**Rename** Select and press **OK**.



Change the name.

**Save** Press the display key



Back: Press and **hold** key.

**Rejecting/accepting an unregistered Bluetooth device**

If a Bluetooth device that is not registered in the list of known devices tries to connect with the handset, you will be prompted on the display to enter the PIN for the Bluetooth device (bonding).

**◆ Reject**

**Go Back** Press the display key.

**◆ Accept**

Enter the PIN for the Bluetooth device you want to **accept** and press **OK**.

If you have accepted the device, you can use it temporarily (i.e. as long as it is within receiving range or until you deactivate the handset) or save it to the list of known devices.

Once the PIN has been confirmed, save to the list of known devices:

- **Yes** Press the display key.
- **No** Press the display key: use temporarily.

**Changing the Bluetooth name of the handset**

You can change the name of your handset used to identify it on the display of other Bluetooth devices.

 →  → Data Transfer → Bluetooth  
→ Own Device Name

**Change** Press the display key



Change the name.

**Save** Press the display key



Back: Press and **hold** key.

**Setting your own area code**

In order to transfer phone numbers via Bluetooth connections to the phone (Gigaset S68H handset) and to correctly manage entries in your directory, it is essential that your area code (international and local area code) is saved on the phone.

If necessary these numbers are already preset.

 →  → Handset → Area Codes

Check that the (pre)set area code is correct.

► Change multiple line input:



Select/change input field.



Navigate in the input field.



Delete number if necessary:  
Press the display key.



Enter number.

**Save** Press the display key.

**Example:**

Area Codes	
<b>International code:</b>	00 - 44
<b>Local area code:</b>	0 - [ 20 ]
<b>&lt;C</b>	<b>Save</b>

**Please note:**

For how to enter your own area code using the Web configurator, see page 123.



### Restoring the handset to the factory settings

---

Each individual handset setting is reset, in particular the language, display, volume, ringer and alarm clock settings (see from page 86 onwards). The last number redial list is cleared.

Entries in the directory, the call-by-call list, the call history, the SMS lists and the handset's registration to the base station as well as the content of My stuff are retained.

 →  → **Handset** → **Reset Handset**

**Yes**

Press the display key. You can cancel the factory reset by pressing  or the display key **No**.



Press and **hold** (idle status).

### Base station settings

---

The base station settings are carried out using a registered Gigaset S67H/S68H handset.

### Protecting against unauthorised access

---

Protect the system settings of the base station with a PIN known only to yourself. You have to enter the system PIN if, among other things, you register and de-register a handset, change VoIP settings or reset the phone to factory settings.

### Changing the system PIN

---

You have to enter the system pin when, for example, you register a handset with the base station, change VoIP settings or start the Web configurator.

You can change the base station's 4-digit default system PIN ("0000") to a 4-digit system PIN known only to yourself.

 →  → **Base** → **System PIN**



Enter the current system PIN and press **OK**.



Enter new system PIN.



Scroll to the **Re-enter PIN:** line.



Now re-enter the new system PIN and press **OK**.

For security reasons, "\*\*\*\*" is displayed instead of the system PIN.



Press and **hold** (idle status).

### Restoring the base station to the factory settings

---

## Resetting the base station via the menu

Each individual setting is reset, in particular:

- ◆ VoIP settings such as VoIP provider and account data and DTMF settings (page 99, page 110, page 122)
- ◆ Settings for the local network (page 101, page 109)
- ◆ Default connection (page 98)
- ◆ The names of the handsets (page 83)
- ◆ SMS settings (e.g. SMS centres, page 53)
- ◆ Settings for the connection to the PABX (page 102)
- ◆ On the Gigaset S675/S685 IP: The answer machine settings (page 65) and own announcements are deleted

The following lists are deleted:

- ◆ SMS lists
- ◆ Calls list
- ◆ On the Gigaset S675/S685 IP: Answer machine lists

The following are **not** reset:

- ◆ Date and time
- ◆ System PIN

The handsets are still registered.

 →  → Base → Base Reset



Enter the system PIN and press **OK**.

**Yes**

Press the display key to confirm.

## Resetting the base station using a key on the base station

As with resetting the base station via the menu, all individual settings are reset. The **system PIN** will also be reset to **"0000"** and **all handsets** registered above and beyond the scope of delivery will be **de-registered**.

### Please note:

For how to re-register the handsets after resetting, if necessary, see page 81.

- ▶ Remove the cable connections from the base station to the router (page 15) and fixed line network (page 14).
- ▶ Remove the base station mains adapter from the socket (page 14).
- ▶ **Press and hold** the registration/paging key (page 2).
- ▶ Plug the mains adapter back into the power socket.
- ▶ Continue to press and hold the registration/paging key (at least 2 sec.).
- ▶ Release the registration/paging key. The base station has now been reset.

## Activating/deactivating music on hold

 →  → Base

Music on hold

Select and press **OK** to activate or deactivate music on hold ( = on).

## Activating/deactivating repeater mode

---

With a repeater you can increase the range and reception strength of your base station. You will need to activate repeater mode. This will terminate any calls being made via the base station at that time.

### Preconditions:

- ◆ A repeater is registered with the base station.
- ▶ Eco mode is deactivated (page 20).

 →  → **Base** → **Add. Features**

### Repeater Mode

Select and press **OK** ( = on).

**Yes** Press the display key to confirm the security prompt.

## Set default connection

---

You can make settings according to whether you want to make calls via VoIP or the fixed line network by default.

### Please note:



- The standard connection is only relevant when dialling numbers that are not subject to dialling plans (page 124) and are entered without a line suffix (page 27).
- For how to set the default connection using the Web configurator, see page 119.

 →  → **Telephony** → **Default Line**

### VoIP / Fixed Line

Select and press **OK** ( = on).

### When making calls:

- ▶ Press the talk key  **briefly** if you want to make the call via the default connection.
- ▶ Press and **hold** the talk key  if you want to make the call via the other connection type.

## Updating the base station firmware

---

If necessary, you can update your base station firmware.

The firmware update is downloaded directly from the Internet by default. The relevant Web page is preconfigured in your phone.

### Precondition:

The base station is in idle status, i.e.:

- ◆ No calls are being made via the fixed line network or VoIP.
- ◆ There is no internal connection between the registered handsets.
- ◆ No other handset has opened the base station menu.

## Starting the firmware update manually

---

 →  → **Base**

### Software Update

Select and press **OK**.



Enter the system PIN and press **OK**.

The base station establishes a connection to the Internet or to the local PC.

**Yes** Press the display key to start the firmware update.

### Please note:

- The firmware update can last up to 3 minutes.
- When updating from the Internet, checks are made to ensure that no newer version of the firmware exists. If this is not the case, the operation is terminated and a message is issued to that effect.

## Automatic firmware update

Your phone will check daily whether a newer firmware update is available via the Internet on the Siemens configuration server. If this is the case, the message **New firmware available** is displayed when the handset is in idle status and the message key  flashes.

 Press the message key.

**Yes** Press the display key to confirm the prompt.

The firmware will be loaded onto your phone.

### Please note:

- If you reply to the prompt with **No**, the display will not be repeated. The message **New firmware available** will only be shown again if a newer version of the firmware than the one rejected is available.
- You can deactivate the automatic version check via the Web configurator (page 133).

## Making VoIP settings

In order to be able to use VoIP, you must set a few parameters for your phone.

You can make the following settings using your handset.

- ◆ Download the general access data for your VoIP provider from the Siemens configuration server and store them on your phone.
- ◆ Enter your personal access data for your first VoIP account (first VoIP phone number). You can configure the access data for five further VoIP accounts via the phone's Web configurator.
- ◆ Set the phone's IP address in the LAN.

### Please note:

You can set these and other parameters conveniently via the Web configurator on a PC connected to your local network (see page 110).

The connection assistant on your phone can help you make the settings.

## Using the connection assistant

The connection assistant starts automatically when you set the handset and base station up for the first time, or when you try to connect to the Internet before making the necessary settings.

You can also start the connection assistant via the menu:

 →  → **Telephony**

**Connection Assist.**

Select and press **OK**.



Enter the system PIN and press **OK**.

For how to enter VoIP settings using the connection assistant, see page 16.

## Changing settings without the connection assistant

You can change your provider's VoIP settings and the VoIP user data via the menu without starting the connection assistant.

### Downloading your VoIP provider's settings

The general settings for various VoIP providers are available for download on the Internet. The relevant Web page is preconfigured in your phone.

**Precondition:** Your phone is connected to the Internet.

 →  → **Telephony** → **VoIP**

 Enter the system PIN and press **OK**.

#### Select Provider

Select and press **OK**.

The phone establishes a connection to the Internet.

 Select country and press **OK**.

 Select your VoIP provider and press **OK**.

Your VoIP provider data is downloaded and saved in your phone.

#### Please note:

- If an error occurs during the download, an error message will be displayed. You can find possible messages and measures in the table on page 136.
- You can make and adapt the general settings for your VoIP provider manually via your phone's Web configurator, see page 111.

### Automatic update for the VoIP provider settings

After the first download of the VoIP provider settings, your phone will check daily whether a newer version of the file for your VoIP provider is available via the Internet on the Siemens configuration server. If this is the case, the message **New profile available** will be displayed when the handset is in idle status, and the message key  flashes.

 Press the message key.

**Yes** Press the display key to confirm the prompt.

 Enter the system PIN and press **OK**.

The new data for your VoIP provider will be downloaded and saved on the phone.

#### Please note:

- If you reply to the prompt with **No**, the display will not be repeated. The message **New profile available** will only be shown again if a newer version of the VoIP settings than the one rejected is available.
- You can deactivate the automatic version check via the Web configurator (page 133).

### Entering/changing VoIP user data

The VoIP settings must also be extended for your personal data. You will receive all necessary data from your VoIP provider.

#### Please note:

When making these entries, please remember the VoIP user data is case sensitive. To enter text see page 147.

 →  → **Telephony** → **VoIP** (Enter system PIN) → **Provider Registr.**

▶ Change multiple line input:

#### Username:

Enter the user name (caller ID) for your VoIP provider account. **Username** is often identical to your Internet telephone number (the first part of your SIP address, see page 113).

**Authent. Name: / Authent. Password:**

Enter the provider-dependent access data that has to be transferred by the phone to the SIP service at registration.

- ▶ Click **Save** to save the settings.

## Setting the phone's IP address in the LAN

The base station requires an IP address in order to be "recognised" by the LAN.

The IP address can be assigned to the base station automatically (by the router) or manually.

- ◆ If performed **dynamically**, the router's DHCP server automatically assigns the base station an IP address. The base station's IP address can be changed according to router settings.
- ◆ If performed manually/**statically**, you assign the base station a static IP address. This may be necessary depending on your network configuration.

**Please note:**

- For how to make the local network settings on the Web configurator, turn to page 109.
- To assign the IP address dynamically, the DHCP server on the router must be activated. Please also read the user guide for your router.

 →  → **Base** → **Local Network**

 Enter the system PIN and press **OK**.

- ▶ Change multiple line input:

**IP Address Type:**

Select **Static** or **Dynamic**.

If you select **Static**, you must manually define the IP address and the subnet mask for the base station in the next lines, as well as the standard gateway and DNS server.

**IP Address:**

For **IP Address Type = Dynamic:**

The IP address that is currently assigned to the base station will be displayed. It cannot be amended.

For **IP Address Type = Static:**

Enter the IP address that is to be assigned to the base station (overwriting the current settings).

192.168.2.2 has been preset.

For the IP address see also page 165.

**Subnet Mask:**

For **IP Address Type = Dynamic:**

The subnet mask that is currently assigned to the base station will be displayed. It cannot be amended.

For **IP Address Type = Static:**

Enter the subnet mask to be assigned to the base station (overwriting the current settings).

The default setting is 255.255.255.0

For the subnet mask see also page 168.

**DNS Server:**

For **IP Address Type = Static:**

Enter the IP address for the preferred DNS server. The DNS server (Domain Name System) converts the symbolic name of a server (DNS name) into the public IP address for the server when the connection is made.

You can specify your router's IP address here. The router forwards phone address requests to its DNS server.

192.168.2.1 has been preset.

**Default Gateway:**

For **IP Address Type = Static:**

Enter the IP address for the standard gateway, by means of which the local network is connected with the Internet. This is generally the local (private) IP address for your router (e.g. 192.168.2.1). Your phone requires this information to be able to access the Internet.

192.168.2.1 has been preset.

- ▶ Click **Save** to save the settings.

### Please note:

You can find notes on the IP address and the subnet mask on page 109 and in the glossary on page 165/page 168.

## Activating/deactivating display of VoIP status messages

If the function is activated, a VoIP status code for your service provider is displayed.

Activate the function if, for example, you have problems with VoIP connections. You will receive a provider-specific status code, which supports the service when the problem is analysed. You will find a table with the possible status screens in the appendix (page 140).

 →  → **Telephony** → **VoIP**

 Enter the system PIN and press **OK**.

**Show Stat. on HS**







Select and press **OK** ( = on).

### Please note:

For how to make the setting on the Web configurator, see page 135.

## Checking the base station MAC address

Depending on your network configuration, you may have to enter your base station MAC address, for example, into your router's access control list. You can check your base station MAC address:

  **8**  **5**  **9**  **2**  **0**  **+**

The base station MAC address is displayed.

 Press and **hold** (idle status).

## Operating the base station on the PABX

The following settings are only necessary when your PABX requires them; see the PABX user guide. The settings only concern fixed line network connections.

You cannot send or receive SMS messages on PABXs that do not support Calling Line Identification.

## Changing the dialling mode

You can set the dialling mode.

 →  → **Telephony** → **Fixed Line**  
→ **Dialling Mode**

**Tone / Pulse**

Select and press **OK** ( = on).



Press and **hold** (idle status).

### Please note:

- Suffix dialling (to select the connection) is not possible in pulse dialling mode: A hash "#" is displayed when dialling, but is ignored when pulse dialling.
- Enter an asterisk "\*" to switch temporarily to tone dialling. The asterisk is not displayed.

## Setting recall

You can set the recall option.

 →  → **Telephony** → **Fixed Line**  
→ **Recall**



Select recall and press **OK**.

The current setting is indicated by .



Press and **hold** (idle status).

## Setting pauses

---

### Changing pause after line seizure

---

You can set the length of the pause inserted between pressing the talk key  and sending the phone number.



Enter a number for the length of the pause (1 = 1 sec.; 2 = 3 sec.; 3 = 7 sec.) and press **OK**.

### Changing the pause after the recall key

---

You can change the length of the pause if your PABX requires this (refer to the user guide for your PABX).



Enter a number for the length of the pause (1 = 1 sec.; 2 = 2 sec.; 3 = 3 sec.; 4 = 6 sec.) and press **OK**.

## Switching temporarily to tone dialling (DTMF)

---

If your PABX still operates with dial pulsing (DP), but you need touch tone dialling for a connection (e.g. to listen to the network mailbox for your fixed line network connection) you must switch to touch tone dialling for the call.

**Precondition:** You are currently conducting an external call via the fixed line network or you have dialled an external fixed line network number or an external call is signalled.

**Options**    Open menu.

**Tone Dialing** Select and press **OK**.

Touch tone dialling is now activated **for this call only**.



## Web configurator – configuring phone via PC

---

The Web configurator is the Web interface for your phone. It allows you to make the settings for your phone's base station via your PC's Web browser.

**Please note:**

Depending on your VoIP provider, it is possible that you will be unable to change individual settings in the Web configurator.

**Preconditions:**

- ◆ A standard Web browser is installed on the PC, e.g. Internet Explorer version 6.0 or higher, or Firefox version 1.0.4 or higher.
- ◆ The phone and PC are connected with each other via a router.

**Please note:**

- The phone is **not** blocked while you make your settings in the Web configurator. You can also use your phone to make calls or change base station or handset settings on your handset at the same time.
- While you are connected to the Web configurator, it is blocked to other users. It cannot be accessed by more than one user at any time.

**With the Web configurator on your phone you have the following options:**

- ◆ Configure your phone access to the local network (IP address, gateway to the Internet).
- ◆ Configure your phone for VoIP. Assign up to six VoIP phone numbers to your telephone.
- ◆ Load new firmware onto the phone if necessary.
- ◆ Use internet services: Enable access to an online directory, display text information on the handset (info services) and synchronise the telephone's date/time with a time server on the Internet.

- ◆ Manage the names and internal numbers of registered handsets and your local directories
- ◆ Obtain information about your phone's status (firmware version, MAC address, etc.).

## Connecting PC with Web configurator

---

**Precondition:** The settings of a firewall installed on your PC allow the PC and phone to communicate with each other.

There are two ways of connecting your PC to the base station Web configurator:

- ◆ via the (local) IP address of the base station
- ◆ via Gigaset config

**Establishing a connection via the IP address:**

- ▶ Establish the telephone's current IP address on the handset:  
You can see the phone's current IP address in the handset display by **briefly** pressing the paging key on the base station.  
Your phone's IP address can change if you have activated dynamic IP address assignment (page 109).
- ▶ Launch the Web browser on your PC.
- ▶ Enter **http://** and the phone's IP address into the address field of the Web browser, e.g. **http://192.168.2.2**.
- ▶ Press the return key.

A connection is established to the phone's Web configurator.

**Establish a connection via Gigaset config:**

**Precondition:** The router is connected to the Internet and your PC can access the Internet via the router.

- ▶ Launch the Web browser on your PC.
- ▶ Enter the following URL into the Web browser's address field:  
<http://www.Gigaset-config.com>
- ▶ Press the return key.

You will receive a message stating the connection will be forwarded to your base station.

If several Gigaset VoIP phones can be reached via your Internet connection, you will be asked to which one of these phones you would like to be forwarded.

After successfully forwarding the connection, the **Login** Web page of the Web configurator will be displayed in the Web browser.

**Please note:**

The connection between the PC and the Web configurator is a local connection (LAN connection). The Internet is only accessed to establish the connection.

## Logging in, setting the Web configurator language

---

Once you have successfully established the connection, the **Login** Web page will be displayed in the Web browser.

You can select the language you want the menus and Web configurator dialogues to be displayed in. The language that is currently selected is displayed in the top field of the Web page.

- ▶ If necessary, click  to open the list of available languages.
- ▶ Select the language.
- ▶ In the bottom field of the Web page, enter your phone's system PIN (default setting: 0000) to access the Web configurator functions.

- ▶ Click **OK**.

Once you have successfully logged in, a **Home** screen opens with general information on the Web configurator.

**Please note:**

- If you have forgotten your system PIN, you must restore your device's factory settings. Please note that this will restore all other settings too (page 97).
- If you do not make any entries for a lengthy period (around 10 minutes), you will be automatically logged off. The next time you try to make an entry or open a Web page, the **Login** Web page will be displayed. Enter the system PIN again to log in again.
- Any entries that you did not save on the phone before automatic log-off will be lost.

## Logging off

---

In the menu bar (page 106) at the top right of every Web page in the Web configurator, you will see the **Log Off** command. Click **Log Off** to log off from the Web configurator.

**Warning:**

Always use the **Log Off** command to end the connection to the Web configurator. If, for example, you close the Web browser without logging off beforehand, it is possible that access to the Web configurator will be blocked for a few minutes.

## Structure of the Web pages

The Web pages contain the UI elements displayed in Figure 2.

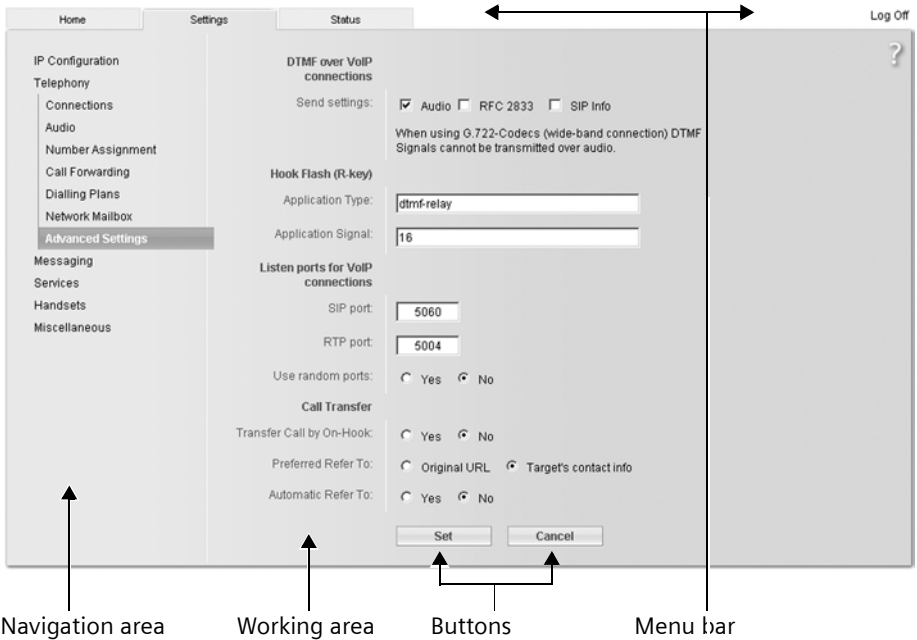

Figure 2 Example of the structure of a Web page

### Menu bar

In the menu bar, the Web configurator menus are offered in the form of tab pages.

The following menus are available:

- ◆ **Home**  
The start screen is opened once you have registered with the Web configurator. It contains information on the Web configurator functions.
- ◆ **Settings** (page 108)  
This menu allows you to make settings on your phone.

- ◆ **Status** (page 135)  
This menu gives you information about your phone.  
If you click the **Settings** menu, a list with this menu's functions is displayed in the navigation area (see below).  
You will find the **Log Off** function to the right of the menu bar on every Web page (page 105).

**Please note:**  
You will find an overview of the Web configurator menu on page 25.

## Navigation area

---

In the navigation area, the functions of the menu selected in the menu bar (page 106) are listed.

If you click a function, the associated page opens in the working area with information and/or fields for your inputs.

If a function is assigned subfunctions, these are displayed with the function as soon as you click the function. The relevant page for the first subfunction is displayed in the working area.

## Working area

---

Depending on the function selected, information or dialogue boxes are displayed in the working area, which allow you to make or change your phone settings.

## Making changes

Make settings for entry fields, lists or options.

- ◆ There may be restrictions regarding the possible values for a field, e.g. entering special characters or certain value ranges.
- ◆ To open a list, click . You can choose between default values.
- ◆ There are two kinds of options:
  - Options in a list, from which you can activate one or several options. Active, i.e. selected options are highlighted with , non-active options with . You can activate an option by clicking . The status of the other options in the list does not change. You can deactivate an option by clicking .
  - Alternative options. The active option in the list is highlighted with , and the non-active with . You can activate an option by clicking . The previously activated option is deactivated. You can only deactivate an option by activating another option.

## Applying changes

As soon as you have made your change on a page, activate the new setting on the phone by clicking **Set**.

If your input in a field does not comply with the rules for this field, an appropriate error message will be displayed. You can then repeat the input.

### Warning:

Changes that have not been saved on your phone are lost if you move to another Web page or if the Web configurator is terminated, e.g. due to the time limit (page 105).

## Buttons

Buttons are displayed in the bottom section of the working area.

### Set

Save entries on the phone.

### Cancel

Reject changes made on the Web page and reload the settings that are currently saved in your phone to the Web page.

## Opening Web pages

---

A brief outline of the navigation to the individual Web configurator functions is given below.

### Example:

#### Setting DTMF signalling

**Settings** → **Telephony** → **Advanced Settings**

To open the Web page, carry out the following steps after registration:

- ▶ Click the **Settings** menu in the menu bar.
- ▶ Click the **Telephony** function in the navigation area.
  - The subfunctions of **Telephony** are displayed in the navigation tree.
- ▶ Click the **Advanced Settings** subfunction.

The Web page from Figure 2 will be shown in the Web browser.

## Setting the phone with Web configurator

---

You can make the following settings using the Web configurator:

- ◆ Connecting your phone to the local network (page 109)
- ◆ Configuring for telephony
  - Enter the VoIP provider settings and configure VoIP accounts and activate/deactivate (page 111)
  - Specify the name of the fixed line network (page 116)
  - Activate/deactivate the Gigaset.net connection (page 116)
  - Activate/deactivate call forwarding for calls to your VoIP numbers or to your Gigaset.net number (page 121)
  - Configure settings to improve voice quality for the VoIP connections (page 117)
  - Define the standard connection for your telephone (fixed line network or VoIP) (page 119)
  - Assign VoIP phone numbers to individual handsets as send/receive numbers (page 120)
  - Gigaset S675/S685 IP: Determine fixed line network and VoIP phone numbers for which the answer machine of the base station should record calls (page 121).
  - Define user-specific dialling plans for emergency numbers and for cost-control purposes (page 124)
  - Enter and activate/deactivate the network mailbox for each number assigned to the telephone (page 126)
  - Define the type of DTMF signalling (e.g. for remote operation of a VoIP network mailbox) and the recall key function for VoIP (page 122)
  - Enter settings for call forwarding via VoIP (call placing, i.e. connecting two external callers to each other, page 123)
- ◆ Output of information from an IP info service on the handset (page 128)
- ◆ Selecting an online phone directory, activating/deactivating the caller name display from the online directory (page 129)
- ◆ Synchronisation of date and time on the base station with a time server on the Internet (page 134)
- ◆ Starting firmware updates (page 132)
- ◆ Managing registered handsets
  - Change names and internal numbers of the registered handsets (page 130)
  - Copy contacts from your PC's Outlook address book to the handset directories or save handset directories to your PC (page 130)
  - Activate/deactivate the display of VoIP status messages on your handset (page 132)

## IP Configuration

---

### Assigning the IP address

Make the necessary settings for operating your phone in your local network and to connect it to the Internet. For more detailed explanations of the individual components/terms, see the glossary (page 160).

- ▶ Open the following Web page:  
**Settings → IP Configuration.**
- ▶ In the **Address Assignment** area, select the **IP address type**.

Select **Obtained automatically** if you want your phone to be assigned a dynamic IP address by a DHCP server in your local network. No further settings are necessary for the local network.

Select **Static** if you would like to set up a static IP address for your phone. A static IP address is useful, for example, if port forwarding or a DMZ is set up on the router for the phone.

The following fields are displayed when you select **IP address type = Static**:

#### IP address

Enter an IP address for your phone. This IP address allows your phone to be reached by other subscribers in your local network (e.g. PC).

192.168.2.2 has been preset.

Please note the following:

- The IP address must be from the address block for private use that is used in the router. This is generally in the range 192.168.0.1 – 192.168.255.254 with **Subnet mask** 255.255.255.0. The subnet mask determines that the first three parts of the IP address must be identical for all subscribers in your LAN.

- The static IP address must not belong to the address block (IP pool range) that is reserved for the DHCP server of the router. It must also not be used by another device on the router.

If necessary, check the settings on the router.

#### Subnet mask

Enter the subnet mask for your device's IP address. For addresses from the address block 192.168.0.1 – 192.168.255.254, the subnet mask 255.255.255.0 is generally used. This is preconfigured when the phone is supplied.

#### Default gateway

Enter the IP address for the standard gateway, by means of which the local network is connected with the Internet. This is generally the local (private) IP address for your router (e.g. 192.168.2.1). Your phone requires this information to be able to access the Internet.

192.168.2.1 has been preset.

#### Preferred DNS server

Enter the IP address for the preferred DNS server. DNS (Domain Name System) allows you to assign public IP addresses to symbolic names. The DNS server is required to convert the DNS name into the IP address when connection is being established to a server.

You can specify your router's IP address here. The router forwards phone address requests to its DNS server.

192.168.2.1 has been preset.

#### Alternate DNS server (optional)

Enter the IP address for the alternative DNS server that should be used in situations where the preferred DNS server cannot be reached.

Click **Set** to save the changes.

Click **Cancel** to reject the changes.

### Allowing access from other networks

The default setting for your phone is set so that you can only access your phone's Web configurator via a PC that is in the same local network as your phone. The subnet mask of the PC must match that of the phone.

You can also allow access from PCs in other networks.

**Warning:**

Expansion of access entitlement to other networks increases the risk of unauthorised access.

It is therefore recommended that you deactivate remote access again if you no longer require it.

- ▶ Open the following Web page: **Settings → IP Configuration.**
- ▶ In the **Remote Management** area, activate the **Yes** option to permit access from other networks.

To deactivate remote access, click the **No** option. Access is then limited to PCs in your own local network.

Access to the Web configurator services from other networks is only possible if your router is set accordingly. The router must pass on the service requests from "outside" to Port 80 (default port) of the phone. Please also read the user guide for your router.

To establish a connection, the public IP address or the DNS name of the router and, where applicable, the port number on the router must be indicated in the Web browser of the remote PC.

## Configuring telephone connections

You can configure up to eight numbers on your phone: your fixed line network number, your Gigaset.net number and six VoIP numbers.

You need to set up a VoIP account with a VoIP provider for each VoIP phone number. You must save the access data for each account and for the relevant VoIP provider in the phone. You can assign a name to each connection (VoIP and fixed line network).

To configure the connections:

- ▶ Open the following Web page: **Settings → Telephony → Connections.**

A list (see Figure 3) will be shown with all possible connections that you can configure, or have already configured, for your phone.

IP Connection				
	Name / Provider	Suffix	Status	Active
1.	AnnaIP Sipgate	#1	registered	<input type="checkbox"/>
2.	Michael IP Sipgate	#2	Disabled	<input type="checkbox"/>
3.	IP3 Other Provider	#3	Disabled	<input type="checkbox"/>
4.	IP4 Other Provider	#4	Disabled	<input type="checkbox"/>
5.	IP5 Other Provider	#5	Disabled	<input type="checkbox"/>
6.	IP6 Other Provider	#6	Disabled	<input type="checkbox"/>
Gigaset.net				
	Name	Suffix	Status	Active
	Gigaset.net	#9	registered	<input type="checkbox"/>
Fixed Line Connection				
	Name	Suffix		
	Fixed Line	#0		<input type="button" value="Edit"/>

Figure 3 List of possible connections

The list will show the following:

### Name / Provider

Name of the connection. This will show the name that you have defined for the connection (page 112, page 116) or the default name (IP1 to IP6 for VoIP connections, **Fixed Line** for the fixed line network connection and **Gigaset.net**).

VoIP connections also display the name of the VoIP provider with which you have opened the account. If the name is unknown the display will show **Other Provider**.

### Suffix

Line suffix that you have to add to the phone number of an outgoing call to allow the account assigned to the suffix to be used as the sending account.

Example: If you dial 123456765#1, the connection will be made and billed through the first VoIP account, regardless of the number you have assigned to your handset as the send number and whether you press briefly/press and hold the talk key.

If you dial 123456765#0, the connection will be made via the fixed line network.

### Status

The status of the connection will be shown for VoIP connections:

#### Registered

The connection is activated. The phone has been successfully registered. You can use the connection to make calls.

#### Disabled

The connection is deactivated. The phone is not registering with the corresponding account with the VoIP service. You cannot use the connection to make or receive calls.

#### Registration failed / Server not accessible

Your phone was unable to register with the VoIP service, e.g. because the VoIP access data is incorrect or incomplete or the phone is not connected to the Internet. There is information about

this in the section "Questions and answers" from page 136 onwards.

### Active

You can use the option in the **Active** column to activate () and deactivate () VoIP connections. If a connection is deactivated, the phone will not register for this connection. The connection can be activated/deactivated by clicking directly on the option. The change does not need to be saved.

To configure a connection or to change the configuration of a connection:

- ▶ Click **Edit** next to the connection.

This will open a Web page where you can make the settings needed. More information is available

- ◆ in the section "Configuring the VoIP connection" on page 111 and
- ◆ in the section "Configuring the fixed line connection" on page 116

## Configuring the VoIP connection

---

Open the Web page:

- ▶ Open the following Web page: **Settings** → **Telephony** → **Connections**.
- ▶ Click **Edit** next to the VoIP connection that you want to configure or the configuration of which you want to change.

This will open a Web page where you can make the settings that your phone needs to access your provider's VoIP server.

The Web page always displays the following areas:

- ◆ **IP Connection** (page 112),
- ◆ **Auto Configuration** (page 112)
- ◆ **Personal Provider Data** (page 113).

The areas

- ◆ **General Provider Data** (page 114) and
- ◆ **Network** (page 114)

can be shown and hidden by clicking the **Show Advanced Settings** and **Hide Advanced Settings** buttons.



## Web configurator –configuring phone via PC

You must enter the VoIP provider's general access data in these areas. You can download this data for many VoIP providers from the Internet (see "Area: Auto Configuration").

- ▶ Make the settings on the Web page.
- ▶ Save them in the phone, see page 116.
- ▶ Activate the connection if necessary, see page 116.

### Area: IP Connection

#### Connection Name or Number

Enter a name for the VoIP connection or the VoIP phone number (max. 16 characters). This name is used to display the connection on the handset and the Web configurator interface, e.g. during allocation of send and receive numbers (page 120), for the call display (page 29).

### Area: Auto Configuration

The entire configuration process or a large part of the configuration for a VoIP connection is automated for many VoIP providers. You can download the necessary VoIP access data to your telephone from the Internet.

You have the following options:

- ◆ Fully automated configuration

#### Preconditions:

- You have received an **auto configuration code** from your VoIP provider.
- The general access data for your VoIP provider is available for downloading.

You can download all the data required for VoIP access from the Internet:

- ▶ Enter the auto configuration code you received from your VoIP provider in the **Auto Configuration** area in the **Auto Configuration Code** field.
- ▶ Click **Start Auto Configuration**.

The telephone establishes a connection to the Internet and downloads all data required for the VoIP connection, i.e. the general provider information and your personal provider data (account data) are saved to your base station.

If further information is used on the Web page, this is deleted as soon as **Start Auto Configuration** is clicked. The fields in the **Personal Provider Data** and **General Provider Data** areas and the server addresses in the **Network** area are overwritten by the downloaded data. Generally, you should not have to enter any additional data on this Web page.

#### Please note:

If the message **Download of settings not possible! File is corrupt!** appears, no data will be loaded onto the phone. Possible causes of this are:

- The incorrect code has been entered (e.g. upper/lower case rules have not been followed). If necessary, enter the code again.
- The file that has been downloaded is invalid. Please consult your VoIP provider.

When the download is complete, the **Connections** list will be displayed.

- ▶ Activate the connection as described on page 116.

You can now be reached on the corresponding VoIP phone number.

- ◆ Automatic configuration of general VoIP provider data

**Precondition:** You have received your account details from your VoIP provider (e.g. **Authentication Name**, **Authentication password**).

Profile files of the most important VoIP providers are available for download on the Siemens Internet server. The address for the server is stored in your phone (page 132).

Proceed as follows to load the data onto your telephone:

- ▶ In the **Auto Configuration** area, click **Select VoIP Provider**. This will display information on the download procedure.

**Please note:**

If you click the **Select VoIP Provider** button, any changes that have been made to the Web page will be saved and checked. Values may need to be corrected before the **Select VoIP Provider** operation is started.

The download procedure has several steps:

- ▶ Click **Next**.
- ▶ From the list, select the country for which the list of VoIP providers is to be loaded.
- ▶ Click **Next**.
- ▶ Select your VoIP provider from the list.

If your provider is not included in the list, select **Other Provider**. In this case you will have to enter the general provider data by hand (see "Area: General Provider Data" and "Area: Network" below).

- ▶ Click **Finish**.

The details of the selected provider are loaded to your phone and saved under **General Provider Data** (page 114) and **Network** (page 114). You cannot make any further entries in these areas.

The **Provider** field shows the name of the selected provider or **Other Provider**. A link to the provider's homepage is displayed where available.

To complete configuration of your VoIP connection enter your account data under **Personal Provider Data**.

### Area: Personal Provider Data

Enter the configuration data that is necessary for accessing your VoIP provider's SIP service. You will receive this data from the VoIP provider.

The field names (**Authentication Name** etc.) listed in the following are standard names and may change. If you have already downloaded the provider's general details ("**Select VoIP Provider**" button, see above), field entries will be replaced by provider-specific names to facilitate orientation (e.g. SIP-ID instead of **Authentication Name**).

#### Authentication Name

Specify the registration or authentication ID agreed with your VoIP provider. The registration ID serves as the access ID that your phone must specify when registering with the SIP proxy/registrar server. The **Authentication Name** is mainly identical to the **Username**, i.e. to your Internet phone number.

#### Authentication password

Enter the password that you have agreed with your VoIP provider in the **Authentication password** field. The phone needs the password when registering with the SIP proxy/registrar server.

#### Username

Enter the user name (caller ID) for your VoIP provider account. This ID is usually identical to the first part of your SIP address (URI, your Internet phone number).

**Example:** If your SIP address is "987654321@provider.com", enter "987654321" in **Username**.

#### Display name (optional)

Enter any name that should be shown in the other caller's display when you call them via the Internet (example: Anna Sand). All characters in the UTF8 character set (Unicode) are permitted. The name must not exceed 32 characters.

## Web configurator –configuring phone via PC

If you do not enter a name, your **User-name** VoIP phone number will be displayed.

Ask your VoIP provider if this feature is supported.

### Area: General Provider Data

If you have downloaded the general settings for the VoIP provider from the Siemens configuration server (page 112), then the fields in this area will be preset with the data from the download. Generally speaking, you do not need to configure any settings in this area.

#### Domain

Specify the last part of your SIP address (URI) here.

**Example:** For the SIP address "987654321@provider.com", enter "provider.com" in **Domain**.

#### Proxy server address

The SIP proxy is your VoIP provider's gateway server. Enter the IP address or the (fully-qualified) DNS name of your SIP proxy server. **Example:** myprovider.com.

#### Proxy server port

Enter the number of the communication port that the SIP proxy uses to send and receive signalling data (SIP port). Port 5060 is used by most VoIP providers.

#### Registrar server

Enter the (fully-qualified) DNS name or the IP address of the registrar server. The registrar is needed when the phone is registered. It assigns the public IP address/port number to your SIP address (**Username@Domain**) that were used by the phone at registration. With most VoIP providers, the registrar server is identical to the SIP server.

**Example:** reg.myprovider.com.

#### Registrar server port

Enter the communication port used in the registrar. It is mainly port 5060 that is used.

### Registration refresh time

Enter the time intervals at which the phone should repeat the registration with the VoIP server (SIP proxy) (a request will be sent to establish a session). The repeat is required so that the entry of the phone in the tables of the SIP proxy is retained and the phone can therefore be reached. The repeat will be carried out for all activated VoIP phone numbers.

The default is 180 seconds.

If you enter 0 seconds, the registration will not be repeated periodically.

### Area: Network

#### Please note:

If you have downloaded the general settings for your VoIP provider from the Siemens configuration server (page 112), then some fields in this area will be preset with the data from the download (e.g. the settings for the STUN server and outbound proxy).

If your phone is connected to a router with NAT (Network Address Translation) and/or a firewall, you must make some settings in this area so that your phone can be reached from the Internet (i.e. can be addressed).

Through NAT, the IP addresses of subscribers in the LAN are concealed behind the public IP address of the router.

#### For incoming calls

If port forwarding is activated or a DMZ is set up for the phone on the router, no special settings are required for incoming calls.

If this is not the case, an entry in the NAT routing table (in the router) is necessary in order for the phone to be reached. This entry is created when the phone is registered with the SIP service. In the interest of security, this entry is automatically deleted at certain intervals (session timeout). The phone must therefore confirm its registration at certain intervals (see **NAT refresh time**, page 115), so that the entry stays in the routing table.

## For outgoing calls

The phone needs its public address in order to receive caller voice data.

There are two possibilities:

- ◆ The phone requests the public address from a STUN server on the Internet (Simple Transversal of UDP over NAT). STUN can only be used with asymmetric NATs and non-blocking firewalls.
- ◆ The phone does not direct the connection request to the SIP proxy but to an outbound proxy on the Internet that supplies the data packets along with the public address.

The STUN server and outbound proxy are used alternately to work around the NAT/firewall in the router.

### STUN enabled

Click **Yes** if you want your phone to use STUN as soon as it is used on a router with asymmetric NAT.

### STUN server

Enter the (fully-qualified) DNS name or the IP address of the STUN server on the Internet.

If you selected **Yes** in the **STUN enabled** field, you must enter a **STUN server** here.

### STUN port

Enter the number of the communication port on the STUN server. The default port is 3478.

### STUN refresh time

Enter the time intervals at which the phone should repeat the registration with the STUN server. The repeat is required so that the entry of the phone in the tables of the STUN server is retained. The repeat will be carried out for all activated VoIP phone numbers.

Ask your VoIP provider for the **STUN refresh time**.

The default is 240 seconds.

If you enter 0 seconds, the registration will not be repeated periodically.

## NAT refresh time

Specify the intervals at which you want the phone to update its entry in the NAT routing table. Specify an interval in seconds that is a little smaller than the NAT session timeout.

As a rule you should not change the preconfigured value for the **NAT refresh time**.

## Outbound proxy mode

Specify when the outbound proxy should be used.

### Always

All signalling and voice data sent by the phone is sent to the outbound proxy.

### Auto

Data sent by the phone is only sent to the outbound proxy when the phone is connected to a router with symmetric NAT or blocking firewall. If the phone is behind an asymmetric NAT, the STUN server is used.

If you have set **STUN enabled = No** or have not entered a STUN server, the outbound proxy is always used.

### Never

The outbound proxy is not used.

If you do not make an entry in the **Outbound proxy** field, the phone behaves independently of the selected mode, as with **Never**.

## Outbound proxy

Enter the (fully qualified) DNS name or the IP address of your provider's outbound proxy.

### Please note:

With many providers, the outbound proxy is identical to the SIP proxy.

## Outbound proxy port

Enter the number of the communication port used by the outbound proxy.

The default port is 5060.

### Saving settings on the phone

- ▶ Click **Set** to save the changes.

The **Connections** list will be shown after saving (see Figure 3 on page 110).

If you want to reject the changes that have been made, click **Cancel**.

Clicking the **Delete** button will reset all the values back to their default settings. Fields with default settings are empty.

**Please note:** If you do not make any entries for a lengthy period, the connection to the Web configurator is automatically terminated. Unsaved entries are lost. If necessary, implement temporary security measures. You can subsequently continue the entry and make changes if necessary.

### Activating a new connection

If you have configured a new VoIP connection, you must also activate it.

In the **Connections list**:

- ▶ Activate the relevant option in the **Active** column (  = activated).

Your phone will register itself with the VoIP provider using the relevant access data. Update the Web page (e.g. by pressing F5). The **Status Registered** column will appear if registration was successful. You can now be reached on this VoIP phone number.

#### **Please note:**

Once the new entry has been made, the VoIP phone number is assigned to each handset and also the integrated answer machine as a receive number. For how to adjust the assignment, see page 120.

### Configuring the fixed line connection

You can assign a name to your fixed line connection. This name is used to display the connection on the handset and the Web configurator interface, e.g. during allocation of send and receive numbers (page 120), for the call display (page 29).

- ▶ Open the following Web page: **Settings** → **Telephony** → **Connections**.
- ▶ In the **Fixed Line Connection** area, click the **Edit** button.
- ▶ Enter your fixed line network number or the name of your choice (max. 16 characters) for your fixed line connection in the **Connection Name** or **Number** field. The default is "**Fixed Line**".

### Activating/deactivating the Gigaset.net connection

Your phone is assigned a Gigaset.net phone number on delivery. As soon as you have connected your phone to the Internet, you can make calls using the Gigaset.net and receive calls from other Gigaset.net subscribers, provided that your Gigaset.net connection has been activated. You can deactivate the Gigaset.net connection.

- ▶ Open the following Web page: **Settings** → **Telephony** → **Connections**. The list of connections will be displayed (see Figure 3 on page 110).
- ▶ In the **Gigaset.net** area: use the option in the **Active** column to activate (  ) or deactivate (  ) the Gigaset.net connection.

#### **Please note:**

If you do not use your Gigaset.net connection for six weeks, it is automatically deactivated. You cannot be reached for calls from the Gigaset.net.

The connection is re-activated:

- as soon as you start a search in the Gigaset.net directory (page 34) or
- make a call via Gigaset.net, i.e. dial a number ending in #9 (two attempts may be necessary) or
- activate the connection via the Web configurator as described above.

## Optimising voice quality for VoIP connections

---

You can make general and connection-specific settings to improve the voice quality for VoIP telephony.

- ▶ Open the following Web page:  
**Settings** → **Telephony** → **Audio**.

The voice quality for VoIP connections is mainly determined by the **voice codec** used for transferring the data and the available **bandwidth** of your DSL connection.

In the case of the voice codec, the voice data is digitalised (coded/decoded) and compressed. A "better" codec (better voice quality) means more data needs to be transferred, i.e. perfect voice data transfer requires a DSL connection with a larger bandwidth.

The following voice codecs are supported by your phone:

### G.722

Excellent voice quality. The **broadband** speech codec G.722 works at the same bit rate as G.711 (64 kbit/s per speech connection) but with a higher sampling rate. This allows higher frequencies to be played back. The speech tone is therefore clearer and better than for the other codecs (High Definition Sound Performance).

### G.711 a law / G.711 $\mu$ law

Excellent voice quality (comparable with ISDN). The necessary bandwidth is 64 kbit/s per voice connection.

### G.726

Good voice quality (inferior to that with G.711 but better than with G.729).

Your phone supports G.726 with a transmission rate of 32 kbit/s per voice connection.

### G.729

Average voice quality. The necessary bandwidth is less than 8 kbit/s per voice connection.

Both sides of a phone connection (caller/ sender side and receiver side) must use the same voice codec. The voice codec is negotiated between the sender and the recipient when establishing a connection.

You can influence the voice quality by selecting (bearing in mind the bandwidth of your DSL connection) the voice codecs your phone is to use, and specifying the order in which the codecs are to be suggested when a VoIP connection is established.

### Area: Settings for Bandwidth

The settings in this area influence all VoIP connections (VoIP phone numbers).

#### Allow 1 VoIP call only

You can usually make two VoIP calls at the same time on your phone. If, however, your DSL connection has a narrow bandwidth, there may be problems if two VoIP calls are made at the same time. The data is no longer transferred properly (long voice delay, data losses etc.).

- ▶ Activate **Yes** next to **Allow 1 VoIP call only** to prevent any further parallel VoIP phone connections being established.
- ▶ If you wish to permit two VoIP connections, activate the **No** option.

**Please note:** If only one VoIP connection is permitted, the following VoIP network services are **no longer** available:

- Call waiting  
 Call waiting is not displayed during a call via VoIP
- External consultation call from a VoIP call
- Toggling and initiating a conference call via VoIP

### Voice Quality

Default settings for the codecs used are stored in your phone: one setting optimised for narrow and one for wide bandwidths.

- ▶ Activate one of the options **Optimized for low bandwidth / Optimized for high bandwidth** if you wish to accept a default setting for all VoIP connections. The settings are shown in the **Settings for Connections** area and cannot be changed.
- ▶ Activate the **Own Codec preference** option if you wish to select and set connection-specific voice codecs yourself (see "Area: Settings for Connections").

### Area: Settings for Connections

In this area you can make specific settings for each of your VoIP phone numbers.

You can make the following settings for each VoIP phone number configured on your phone:

#### Volume for VoIP Calls

Depending on the VoIP provider, it is possible that the received voice/earpiece volume is too low or too high, so that adjusting the volume via the handset is not adequate.

Specify whether the received volume range is too high or too low. The following options are available:

#### Low

Voice/earpiece volume is too high. Activate this option to reduce the volume by 6 dB.

#### Normal

The voice/earpiece volume does not need to be raised/lowered.

#### High

Voice/earpiece volume is too low. Activate this option to increase the volume by 6 dB.

### Voice codecs

**Precondition:** The **Own Codec preference** option is activated for the **Voice Quality** in the **Settings for Bandwidth** area.

Select the voice codecs your phone is to use, and specify the order in which the codecs are to be suggested when a VoIP connection is established via this VoIP phone number.

- ▶ Apply the voice codecs that your phone is to suggest with outgoing calls into the **Selected codecs** list. To do this, in the **Available codecs** list click the voice codec that you want to apply (you can mark several entries using the Shift key or the Ctrl key). Click <Add.
- ▶ Move the voice codecs that you do not want the phone to use into the **Available codecs** list. Also, select the voice codecs in the **Selected codecs** list (see above) and click Remove>.
- ▶ Sort the voice codecs in the **Selected codecs** list into the order in which they should be suggested to the receiving device when a connection is established. To do this, use the **Up** and **Down** buttons.

When establishing a VoIP connection, the phone suggests the 1st voice codec in the **Selected codecs** list to the receiving device to begin with. If the receiving device does not accept the codec (e.g. because it is not supported), the 2nd voice codec on the list is suggested, and so on.

If the receiving device does not accept any of the voice codecs in the **Selected codecs** list, the connection is **not** established. An appropriate message will be displayed on the handset.

If the phone always starts by trying to establish a broadband connection, put the **G.722** codec at the top of the list **Selected codecs**.

**Please note:**

- You should only deactivate codecs (put them in the **Available codecs** list) if there is a particular reason. The more codecs that are deactivated, the greater the danger that calls will not be able to be established due to unsuccessful codec negotiations. In particular you can only establish broadband connections if you permit the **G.722** codec
- With incoming calls, all supported voice codecs are always permitted.

**Area: Settings for Codecs**

To save additional bandwidth and transmission capacity, on VoIP connections that use the **G.729** codec you can suppress the transmission of voice packets in pauses ("Silence Suppression"). Then, instead of the background noises in your environment, your caller hears a synthetic noise generated in the receiver.

**Please note:** "Silence Suppression" can sometimes lead to deterioration in the voice quality.

- ▶ In the **Enable Annex B for codec G.729** field, state whether the transmission of data packets during pauses should be suppressed when using the **G.729** codec, (activate **Yes**).

**Saving settings on the phone**

- ▶ Click **Set** to save the settings for the voice quality.

**Please note:**

You should observe the following for good voice quality:

- When making calls using VoIP, avoid performing other Internet activities (e.g. surfing the Internet).
- Irrespective of the codec used and the network capacity utilisation, please note that voice delays can occur.

**Voice quality and infrastructure**

With your Gigaset S685/S675 IP you have the opportunity to make calls with good voice quality via VoIP.

However, your phone's performance with VoIP – and therefore the voice quality – also depends on the properties of the entire infrastructure.

The following VoIP provider components are just some of the things that can influence performance:

- ◆ Router
- ◆ DSLAM
- ◆ DSL transmission line and speed
- ◆ Connection paths over the Internet
- ◆ If necessary, other applications that also use the DSL connection

In VoIP networks, voice quality is affected by various things including the "quality of service" (QoS). If the entire infrastructure demonstrates QoS, voice quality is better (fewer delays, less echoing, less crackling etc.).

If, for example, the router does not have QoS, then the voice quality is not as good. Please see the specialist documentation for further information.

**Setting the telephone default connection**

The default telephone connection defines which line type (VoIP or fixed line network) will be used to dial numbers when you **briefly** press the  key. The default connection is applied to all registered handsets.

- ▶ Open the following Web page: **Settings** → **Telephony** → **Number Assignment**.
- ▶ Enter the default connection in the **Linetype for outgoing calls** area. This can be done by clicking on the **VoIP** or **Fixed Line** option.
- ▶ Now click **Set** to activate your settings.



### Please note:

- The default connection is only relevant when dialling numbers that are not subject to dialling plans and are entered without a line suffix.
- You can change the settings for the default connection via any registered Gigaset handset (page 98)

## Assigning send and receive numbers to handsets

You can assign up to eight numbers on your phone: your fixed line network number, your Gigaset.net number and six VoIP numbers.

You can assign as many of these numbers as you like to each handset as receive numbers. Receive numbers determine which handset(s) will ring when a call is received.

You can assign one of your VoIP numbers to each handset as a (VoIP) send number. Send numbers define which VoIP account should be used in general to make and pay for outgoing VoIP calls. **Exceptions:**

- ◆ A phone number is dialled with a line suffix (page 111) or
- ◆ A dialling plan has been defined for the phone number (page 124).

The Gigaset.net number and fixed line network number are permanently assigned to each registered handset.

### Please note:

A handset is assigned the following numbers after it is registered on the base station:

- Receive numbers: all phone numbers assigned to the phone (fixed line network, Gigaset.net and VoIP).
- Send numbers: the fixed line network number and the VoIP phone number that you entered at the start of the phone configuration.

- ▶ Open the following Web page: **Settings**  
→ **Telephony** → **Number Assignment**.

The display shows all registered handsets. A list is displayed for each handset showing the phone numbers that are configured and activated for the phone. The connection names are shown in the **Connections** column. The fixed line network connection is always at the end of the list.

- ▶ Define a VoIP phone number as the send number for each handset. To do this, click the option following the phone number in the **for outgoing calls** column. The previous assignment will automatically be deactivated.

### Please note:

The fixed line network number is permanently assigned to each handset as a send number. This assignment cannot be deactivated. It ensures that emergency calls can be made from every handset. The Gigaset.net number is also permanently assigned to each handset.

- ▶ Select the phone numbers for each handset (fixed line network, VoIP) that are to be assigned to the handset as receive numbers. To do this, click the option following the phone number in the **for incoming calls** column. Every handset can be assigned several phone numbers or no phone number ( = assigned).
- ▶ Now click **Set** to save your settings.

### Please note:

- If a VoIP phone number that has been assigned to a handset as a send number is deleted, then the handset will automatically be assigned the first configured VoIP phone number.
- Calls made to a number that is not assigned to a handset as a receive number will not be signalled on any handset.
- If you have not assigned receive numbers to any of the handsets, calls to all connections will be signalled on all handsets.

## Gigaset S675/S685 IP: assigning receive numbers to the answer machine

---

You can specify for which of your phone numbers your telephone's answer machine is to accept the calls. To do this, assign receive numbers to the answer machine.

### Please note:

- Once the new entry has been made, each VoIP phone number is assigned to the integrated answer machine as a receive number.
- If no receive number is assigned to the answer machine, it will not accept any calls even if it is activated.
- For how to set and operate the answer machine, see page 61.

- ▶ Open the following Web page: **Settings** → **Telephony** → **Number Assignment**.
- ▶ In the **Answering machine** area, select the phone numbers (fixed line network, VoIP) for which the answer machine is to accept calls (if it is activated, see page 61). To do this, click the option following the phone number in the **for incoming calls** column. You can assign as many numbers as you wish to the answer machine (  = assigned).
- ▶ Now click **Set** to save your settings.

## Activating Call Forwarding for VoIP connections

---

You can forward calls to your VoIP numbers and to your Gigaset.net number.

You can forward calls to your VoIP numbers to any external number (VoIP, fixed line or mobile network number). The forwarding is done via a VoIP connection.

You can forward calls to your Gigaset.net number within the Gigaset.net, i.e. to another Gigaset.net number.

You can define if and when calls to your Gigaset.net number and some of your VoIP numbers (VoIP account) should be forwarded to this VoIP number.

You can also use the handset to define call forwarding and activate/deactivate it, see page 39.

- ▶ Open the following Web page:  
**Settings** → **Telephony** → **Call Forwarding**.

The display shows a list of all your VoIP connections and your Gigaset.net number.

### Connections

Select the name you have assigned to the VoIP number, or select **Gigaset.net**.

### When

Select when a call to this number should be forwarded: **When busy / No reply / Always**. Select **Off** to deactivate call forwarding.

### Call number

Enter the phone number to which the calls should be forwarded. Please note that you may have to enter the area code when forwarding to a fixed line network number in the same area (depending on your VoIP provider and the setting for the automatic area code, see page 123).

The settings only affect the selected phone number.

### Please note:

For how to forward your fixed line network number, see page 37.

## Setting the DTMF-reminder for VoIP

---

DTMF signalling is required, for example, for querying and controlling certain network mailboxes via digit codes or for remote operation of the integrated answer machine.

To send DTMF signals via VoIP you must first define how key codes should be converted into and sent as DTMF signals: as audible information via the speech channel or as "SIP Info" message.

Ask your VoIP provider which type of DTMF transmission it supports.

- ▶ Open the following Web page: **Settings** → **Telephony** → **Advanced Settings**.

In the **DTMF over VoIP connections** area, make the required settings for sending DTMF signals.

- ▶ Activate **Audio** or **RFC 2833**, if DTMF signals are to be transmitted acoustically (in voice packets).
- ▶ Activate **SIP Info** if DTMF signals are to be transmitted as code.
- ▶ Now click **Set** to save your settings.

### Please note:

- The settings for DTMF signalling apply to all VoIP connections (VoIP accounts).
- DTMF signals can not be transmitted in the audio path (**Audio**) on broadband connections (the G.722 codec is used).

## Defining recall key functions for VoIP (hook flash)

---

Your VoIP provider may support special performance features. To make use of these features, your phone needs to send a specific signal (data packet) to the SIP server. You can assign this "signal" to your phone's recall key.

If you press the recall key during a VoIP call the signal will be sent to the server.

- ▶ Open the following Web page: **Settings** → **Telephony** → **Advanced Settings**.
- ▶ Enter the data you received from your VoIP provider into the **Application Type** and **Application Signal** fields in the **Hook Flash (R-key)** area.
- ▶ Now click **Set** to save your settings.

The setting for the recall key applies to all registered handsets.

## Defining local communication ports for VoIP

---

- ▶ Open the following Web page: **Settings** → **Telephony** → **Advanced Settings**.

In the **Listen ports for VoIP connections** area, specify which local ports the telephone is to use for VoIP telephony. The ports must not be used by any other subscriber in the LAN.

### SIP port

Specify the local communication port that the phone should use to send and receive signalling data. Specify a number between 1024 and 49152. The default port number for SIP signalling is 5060.

### RTP port

Specify the local communication port that the phone should use to receive voice data. Enter an **even** number between 1024 and 49152. The port number must **not** be the same as the port number in the **SIP port** field. If you enter an odd number, the next lowest even number will be selected automatically (e.g. you enter 5003, then 5002 is set automatically). The default port number for voice transmission is 5004.

### Use random ports

Click the **Yes** option if you do not want the phone to use fixed ports for **SIP port** and **RTP port**, but rather to use any free ports.

The use of random ports makes sense if you want several phones to be operated on the same router with NAT.

The phones must then use different ports so that the router's NAT is only able to forward incoming calls and voice data to one (the intended) phone.

If you click **No**, the phone will use the ports specified in **SIP port** and **RTP port**.

- ▶ Now click **Set** to save your settings.

## Configuring call forwarding via VoIP

---

If you are toggling calls via VoIP connections, you can connect the two external callers (provider-dependent). You can configure settings for this type of call forwarding.

- ▶ Open the following Web page: **Settings** → **Telephony** → **Advanced Settings**.
- ▶ Configure the following settings in the **Call Transfer** area for call forwarding via VoIP:

### Transfer Call by On-Hook

If you activate **Yes**, the external parties you are toggling between will be connected when you press the end call key . Your connections with the callers will be terminated.

To learn how to forward a call when you have activated **No**, please see page 40.

### Preferred Refer To

Define the protocol (the contents of the "Refer To" information) that should be used with preference when forwarding calls:

#### Target's contact info

This protocol is recommended for "closed" networks (internal company and business networks).

#### Original URL

This protocol is recommended when the base station is connected to the Internet via a router with NAT.

### Automatic Refer To

If you activate **Yes**, the base station will attempt to determine the best protocol automatically.

If the base station cannot determine the best protocol, it will use the protocol defined in **Preferred Refer To**.

- ▶ Now click **Set** to save your settings.

## Setting area code predialling

---

On the base station, save the complete code (with international code) for the area in which you are using the phone.

For VoIP calls you must generally always dial the area code – even for local calls. You can save the need to dial the area code for local calls by setting your phone to prefix this code for all VoIP calls made in the same local area.

For calls made via VoIP, the area code entered is then prefixed to all numbers that do not start with 0 — even when dialling numbers from the directory and other lists. **Exceptions:** Numbers for which you have defined dialling plans (page 124).

- ▶ Open the following Web page: **Settings** → **Telephony** → **Dialling Plans**.

Configure the following settings in the **Area Codes** area:

- ▶ From the **Country** list, select the country in which you are using your phone. This way the country code and the prefix of the area code are automatically set (in **International Prefix / Area Code** and **Local Prefix** fields).
- ▶ In the **Local Area Code** field enter the area code for your town without a prefix, e.g. 20 (for London).
- ▶ Click **Yes** next to **Predial area code for local calls through VoIP** to activate the function.

## Web configurator –configuring phone via PC

Click **No** to deactivate the function. You will then need to enter the area code for local calls made via VoIP. Numbers in the directory must always contain the area code for dialling via VoIP.

- ▶ Click **Set** to save the settings.

### Please note:

- ◆ The area code will also be prefixed to VoIP calls made to emergency numbers if there are **no** defined dialling plans for these numbers.
- ◆ The numbers of your network mailbox saved in the base station are **not** prefixed with a code (page 126).

## Defining dialling plans – cost control

---

You can define dialling plans to reduce costs:

- ◆ You can define the connection (one of your VoIP accounts, the fixed line network) through which calls to specific numbers should be made and paid for. If you enter just a few digits (e.g. area, national or mobile network code) any call to a number beginning with these digits will be made via the elected connection.
- ◆ You can block specific numbers, i.e. your phone will not establish a connection to these numbers (e.g. 0900 numbers).

These dialling plans apply to all registered handsets. The settings for the default connection (briefly press/press and hold ) and the send numbers of handsets do not apply to numbers governed by a dialling plan.

### Please note:

You can override dialling plans, with the exception of blocks, as follows:

- Dial the number with a line suffix (e.g. 123456789#3, see page 27).
- Before you enter the number, define a different connection type by pressing the display keys **FixedLine** / **IP** (page 87). If, for e.g., you press **FixedLine**, the number will be dialled via the fixed line network, even if the dialling plan states that a VoIP connection should be used.

**Area code predialling** is not prefixed to numbers governed by a dialling plan (page 123).

### Tips:

- ◆ Compare the rates for long-distance calls (especially for international calls) offered by your fixed line network and VoIP providers, and determine which connection should be used specifically for these countries/locations, e.g. a dialling plan for the **Phone Number** "0033" would apply to every call made to France.
- ◆ Use dialling plans to define that numbers starting with a call-by-call number are always made via your fixed line network connection. To do so, enter the call-by-call number in the **Phone Number** field.

## Defining dialling plans

---

- ▶ Open the following Web page:  
**Settings** → **Telephony** → **Dialling Plans**.

You can define dialling plans for your telephone in the **Dialling Plans** area. Specify the following:

### Phone Number

Enter the number or the first digits of the phone number (e.g. an area code) to which the dialling plan should apply (max. 15 digits).

Enter each phone number and the area code, even if you have activated the **Predial area code for local calls through VoIP** (page 123) function.

### Connection Type

The list shows all the VoIP connections that you have configured as well as your fixed line network connection. It also displays the name assigned to each connection.

- ▶ From the list, select the connection via which the number or numbers that start with the sequence of digits should be dialled.

Or:

- ▶ Select **Block** if the number or numbers that start with the sequence of digits should be blocked.

The display will show **Not possible!** if an attempt is made to dial a blocked number.

### Comment (optional)

You can enter a description of up to 20 characters for the dialling plan here.

- ▶ Click **Add**.

The dialling plan is activated immediately.

A new empty line for a new dialling plan will appear if your phone still has enough space.

#### **Please note:**

If dialling plans overlap, the one with the greatest concordance will apply.  
 Example: There is a dialling plan for the number "02" and one for the number "023". If you dial "0231 ..." the second plan will apply; if you dial "0208..." the first plan will apply.

### Examples:

- ◆ You want to block your phone for all 0900 numbers.  
 Dialling plan:  
**Phone Number = 0900 Connection Type = Block**
- ◆ All calls to the mobile phone network shall be made via your VoIP connection with provider B.

Dialling plans:

**Phone Number = 017**

**Connection Type = IP3, provider B**

and the corresponding entries for "015" and "016".

### Activating/deactivating dialling plans

- ▶ Click the option in the **Active** column to activate/deactivate the corresponding dialling plan ( = activated).

A deactivated dialling plan will not take effect until it is re-activated.

### Deleting dialling plans

- ▶ Click **Delete** next to the dialling plan you wish to delete.

The dialling plan is deleted from the list immediately. The space in the list is released.

#### **Please note:**

Predefined dialling plans set as defaults (for emergency numbers **cannot** be deactivated and **cannot** be deleted.

### Emergency numbers

Dialling plans for emergency numbers (e.g. the **local** emergency service number) are factory-set for certain countries. The fixed line network is determined as the **Connection Type**.

These dialling plans cannot be deleted, deactivated or blocked. However, you can change the **Connection Type**.

This should only be changed if the phone is not connected to the fixed line network. If you choose a VoIP connection, please make sure the VoIP provider supports emergency calls.

If no emergency numbers are set by default, you should define dialling plans for emergency numbers yourself and assign them to a connection of which you know that it supports emergency calls. Emergency calls are always supported by fixed line networks.

**Warning:**

- Emergency numbers cannot be dialled if the keypad lock is activated. Before dialling, press **and hold** the hash key (**#**), to release the keypad lock.
- If you have activated an automatic area code (page 123) and if no dialling plan for emergency calls is defined, the area code will also be prefixed to emergency calls made via VoIP.

## Activating/deactivating network mailbox, entering numbers

Many fixed line network providers and VoIP providers offer answer machines on the network – these are known as network mailboxes.

Each network mailbox accepts incoming calls made via the corresponding line (fixed line network or corresponding VoIP phone number).

You can enter the relevant network mailbox for each configured connection (VoIP, fixed line network) via the Web configurator. You can activate or deactivate the network mailbox for your VoIP connections.

- ▶ Open the following Web page: **Settings** → **Telephony** → **Network Mailbox**.

A list with all possible connections is displayed on the Web page. The names of the connections are displayed in the **Connection** column.

### Entering numbers

- ▶ Enter the network mailbox number in the **Call number** column after the desired connection.

With some VoIP providers your mailbox number will be downloaded together with the general VoIP provider data (page 112), saved to your base station and displayed under **Call number**.

- ▶ Now click **Set** to save your settings.

## Activating/deactivating the network mailbox

- ▶ You can activate () and deactivate () individual VoIP network mailboxes using the option in the **Active** column. Activating/deactivating is carried out by clicking on the appropriate option. The change does not need to be saved.

**Please note:**

- You need to have **requested** the network mailbox for your fixed line network connection from your fixed line network provider.
- For how to enter the network mailbox numbers and activate/deactivate network mailboxes, please see page 78.

## Saving messenger access data

The messenger client in your base station enables **instant messaging** (immediate message transfer, chatting). The phone supports the XMPP messenger (Jabber).

In order for you to use your phone's messenger to "go online" and "chat" on the Internet, the access data of a messenger server must be saved on your phone.

Your phone is already registered with the Gigaset.net Jabber server. An account has been assigned to your phone. You can chat to other Gigaset.net subscribers via this account. To do this you need to create a buddy list on the PC (see "Setting up Gigaset.net Jabber account" on page 127).

You can also register with another instant messaging provider that supports XMPP Messenger (Jabber). You must then save the messenger server address and your access data on your phone.

You can define a **Resource** name and a **Priority** for your phone. Both are required if you are logged in (online) with the messenger server with several devices (phone, desktop PC and laptop) at the same time using the same Jabber ID.

The **Resource** name is used to distinguish between these devices. The phone cannot log in with the messenger server if it does not have a resource name.

You should assign a **Priority** as each message will only be sent to one device for each Jabber ID. The **Priority** determines which of the devices receives the message.

**Example:** You are online using one of your phone's handsets and your PC both at the same time. You have assigned your phone (**Resource** name "phone") **Priority** 5 and your PC (**Resource** name "PC") **Priority** 10. In this case, any message addressed to your Jabber ID will be sent to your phone.

- ▶ Open the following Web page:  
**Settings → Messaging → Messenger.**
- ▶ In the **Messenger Account** field, select whether you wish to use the **Gigaset.net** Jabber server or another provider's messenger server (**Other**).  
The access data for **Gigaset.net** is already stored in the base station. It is displayed in **Jabber ID**, **Authentication password** and **Jabber server**. With this data you can also register with the Gigaset.net Jabber server through your PC.
- ▶ Enter the user ID (max. 50 characters) and password (max. 20 characters) that you used to register with the messenger server in the **Jabber ID** and **Authentication password** fields. If you have selected **Messenger Account = Gigaset.net**, the fields are preconfigured with your Gigaset.net account.
- ▶ In the **Jabber server** field, enter the IP address or the DNS name of the messenger server with which you are registered for instant messaging.  
Max. 74 alphanumeric characters.  
If you have selected **Messenger Account = Gigaset.net**, the field is preconfigured with the name of the Gigaset.net server.

- ▶ Enter the number of the communication port on the Jabber server in the **Jabber server port** field. The default port is 5222.  
If you have selected **Messenger Account = Gigaset.net**, the port number is preconfigured.
- ▶ Enter a resource name (max. 20 characters) in the **Resource** field.  
The default is: **phone**.
- ▶ Enter the priority for your phone in the **Priority** field. Select a number between -128 (highest priority) and 127 (lowest priority) for the priority.  
The default is: 5
- ▶ Click **Set**.

### Setting up Gigaset.net Jabber account

Your phone is already registered with the Gigaset.net Jabber server. An account has been assigned to your phone.

In order to chat with other Gigaset.net subscribers via this account, you must transfer the required Gigaset.net subscribers to a contact list (buddy list) on your PC. You can use any conventional Jabber client for this (e.g. PSI, Miranda; see e.g. <http://www.swissjabber.ch>).

Do the following so you can use your Gigaset.net Jabber account:

- ▶ Start the Web configurator, open the **Settings → Messaging → Messenger** Web page and select **Messenger Account Gigaset.net** in the field. Your account data is displayed in **Jabber ID** and **Authentication password**. You will need these to create a buddy list via the Jabber client on the PC.
- ▶ Start your Jabber client on the PC.
- ▶ Enter your Gigaset.net **Jabber ID** on the Jabber client as a new account. The **Jabber ID** consists of your Gigaset.net number and "@jabber.gigaset.net"  
Example:  
12345678901#9@jabber.gigaset.net
- ▶ Then enter your **Authentication password**.



### Please note:

- Do **not** select the option "Create new account". Your Gigaset.net Jabber account has already been created in Gigaset.net.
- The option "SSL connection" must be **deactivated** in the Jabber client.

- ▶ Now you can enter Gigaset.net subscribers as contacts (buddies).

For the Jabber ID of each subscriber, enter the subscriber's Gigaset.net number with "@jabber.gigaset.net" (example: 2141524901#9@jabber.gigaset.net).

A request to "Add to contact list" will be sent to the subscriber.

If the subscriber accepts this request, they will be added to your buddy list. This updated buddy list will be displayed on the handset the next time the messenger is rebooted. To restart: If necessary, close your connection to the messenger server (page 73) and then go back online (page 72).

### Please note:

For how to use your handset to go online and chat with or call buddies, see page 71.

## Making e-mail settings

You can use your phone to be notified about new e-mail messages on your incoming e-mail server (page 68).

You must store the address or DNS name of your incoming e-mail server and your personal access data in the phone and activate the e-mail check with the incoming e-mail server, so that the phone can establish a connection to the incoming e-mail server and connect to your mailbox.

- ▶ Open the following Web page:  
**Settings → Messaging → E-Mail.**
- ▶ Enter the user name (account name) agreed with the Internet provider (max. 50 characters) in the **Authentication Name** field.

- ▶ Enter the password that you agreed with your provider for accessing the incoming e-mail server (max. 20 characters; case sensitive) in the **Authentication password** field.
- ▶ Enter the name of the incoming e-mail server (POP3 server) (max. 74 characters) in the **POP3 Server** field. Example: pop.theserver.com.
- ▶ From the **Check for new e-mail** list select the time interval at which your phone should check if new messages have arrived in your incoming e-mail server. Select **Never** to deactivate the prompt. Select one of the other values to activate the prompt for new e-mail messages.
- ▶ Click the **Set** button to save the settings in your phone.

### Please note:

For how to show the messages from your mailbox on your handset, see page 68

## Activating/deactivating info services

You can configure your registered Gigaset S67H/S68H handsets to display customised text information (e.g. weather reports, RSS feeds) on the idle display.

**Precondition:** The **Clock** is set as a screensaver on the handset (page 86).

Incoming text information will overwrite the screensaver.

You can activate and deactivate the display of text information for every handset.

- ▶ Open the following Web page:  
**Settings → Services.**
- ▶ In the **Info services on screensaver** area, activate **Yes / No** to activate or deactivate the display of text information.
- ▶ Click the **Set** button to save the settings in your phone.

## Configuring info services

### Please note:

The weather report is preset. It is shown in the handset's idle display as soon as you set the **Clock** as a screensaver.

- ▶ Click the link [www.gigaset.net/myaccount](http://www.gigaset.net/myaccount) or enter the URL into the address field of a different browser window.
- ▶ Enter the account data shown in the **Info services on screensaver** area into the fields for the user account.

This will open a Web page where you can compile your info service.

- ▶ Define which information should be sent regularly to your handset.

## Selecting and registering online directories for access

You can use online directories (net directory and yellow pages) on your handset. You can use your telephone's Web configurator to define which online directory you wish to use.

You can also elect to display the name under which the caller making an incoming call is saved in the online or Gigaset.net directory (**Display of caller's name**) – in the call display and in the caller list. **Precondition:** This function is supported by the provider of the online directory.

- ▶ Open the following Web page: **Settings** → **Services**.  
The settings are made in the **Online Directory** area.
- ▶ Select the provider whose online directory you wish to use from the **Provider** list. Select "----" if you do not wish to use an online directory.

The following fields are displayed depending on the **Provider** you select:

### Display of caller's name

This is displayed if the provider supports transmission of the caller name from the online directory to the call display (page 30).



- ▶ Click on **On** to update the display.

### Authentication Name, Authentication password

These are displayed if you need to register with the provider to gain access to certain services:

- Some providers require you to register every time you want to access their online directory. They require registration with user name and password for access to the online directory. You will need to save this data to your base station.
- Other providers differentiate between standard and premium services. You can access standard services **without** first entering user name and password. But you will have to register to use the premium services. You will need to save the access data to your base station to gain access to premium services.
- ▶ Enter the details you received from your provider in the **Authentication Name** and **Authentication password** fields.
- ▶ Click the **Set** button to save the settings in your phone.

### Please note:

- How to use online directories on handsets, see page 45.
- The provider-specific name of the online directory and classified directory are displayed in the list of online directories on the handset (press and hold ).
- The handset directories (press  briefly) always display the entries **Net Directory** and **Yellow Pages** for online and classified directories (regardless of the selected provider). However, connections are made to the selected online directories.
- If you select "—" from the **Provider** list the entries for online and classified directories will not be displayed in the handset's list of online directories.  
The directory entries **Net Directory** and **Yellow Pages** are maintained but cannot be used to make any connections.

## Changing internal handset numbers and names

---

Each handset is **automatically** assigned an internal number (1 to 6) and an internal name ("INT 1", "INT 2" etc.) when it registers with the base station (page 81).

The internal numbers and names of all registered handsets can be changed.

### Please note:

You can read how to change internal names and numbers from page 82 onwards.

- ▶ Open the following Web page:  
**Settings** → **Handsets**.

The names and internal numbers of all registered handsets are displayed in the **Registered Handsets** area.

- ▶ Select the handset whose number/name you want to change.
- ▶ **Changing numbers:** Select the internal number that you want to assign to the handset in the **No.** column of the handset. If a handset with this internal number already exists, you will also have to change the number allocation for this handset. The internal numbers 1-6 can only be assigned once each.

- ▶ **Changing names:** If necessary, change the name of the handset in the **Name** column. The name may contain up to 10 characters.
- ▶ If necessary, repeat the process for other handsets.
- ▶ Click **Set** to save the settings.

The changes are present in the internal lists of all registered handsets. Handsets are sorted by their internal numbers in the internal list. The order of the handsets in the list can therefore be changed.

### Please note:

If an internal number has been entered twice, a message will appear. The internal numbers are not changed.

## Loading and deleting handset directories to/from the PC

---

The Web configurator has the following options for editing the directories of the registered handsets.

- ◆ Store the handset directories on a PC. Entries are stored in vCard format in a vcf file on the PC. You can edit these files with an ASCII editor (e.g. Notepad/Editor in Windows Accessories) and load them onto any handset. You can also transfer directory entries to your PC address book (e.g. Outlook Express™ address book).
- ◆ Transfer contact details from your PC address book to handset directories. Export the contacts, e.g. with Outlook Express™ to vcf files (vCards) and transfer them to handset directories using the Web configurator.
- ◆ Delete the directory on the handset. If you have edited the directory file (vcf file) on the PC and would like to use this modified directory on the handset, you can delete the current directory from the handset first.

**Tip:** Back up the current directory on your PC before deleting it. You can then load it back onto the handset if the modified directory is affected by formatting errors and some, or all, of it cannot be loaded onto the handset.

### Please note:

- You can find information on the vCard format (vcf) on the Internet, e.g. under: [www.en.wikipedia.org/wiki/VCard](http://www.en.wikipedia.org/wiki/VCard) or [www.de.wikipedia.org/wiki/VCard](http://www.de.wikipedia.org/wiki/VCard) (You can set the display language at the bottom left-hand side in the navigation area of the Web page.)
- You can still load directories in tsv format from your PC to your handset.
- If you want to transfer a handset directory (vcf file) saved on the PC that contains numerous entries to a Microsoft Outlook™ address book, please note the following: Microsoft Outlook™ only ever transfers the first (directory) entry from the vcf file to its address book.

### Preconditions:

- ◆ The handset can send and receive directory entries.
- ◆ The handset is activated and is in idle status.
- ▶ Open the following Web page:  
**Settings** → **Handsets**.

The names of all registered handsets are displayed in the **Directory** area.

- ▶ Select the handset for which you want to save or edit the directory. To do this, click on the option before the handset.

### Loading the directory file from the PC to the handset

---

- ▶ In the **Transfer directory to handset** area, enter the vcf file you want to load onto the handset (complete path name), or click **Browse...** and navigate your way to the file.
- ▶ Click the **Transfer** button to start the transfer.

The display will show how many of the entries from the vcf file are being transferred to the directory.

### Transfer rules

The directory entries from a vcf file that are loaded onto the handset will be added to the directory. If an entry already exists for a name, it will either be supplemented or a new entry for the name created. The process will not overwrite or delete any phone numbers.

### Please note:

Depending on your handset type, up to 3 entries with the same name will be created in the handset directory for each vCard – one entry per entered number.

### Loading the directory from the handset to the PC

---

- ▶ In the **Handset Directory** area, click **Save**. A Windows dialogue will be shown to save the file.
- ▶ Enter the directory on the PC (complete path name) in which the directory file is to be stored. Click **Save** or **OK**.

### Deleting the directory

---

- ▶ In the **Handset Directory** area, click **Delete**.
- ▶ Confirm the security prompt **Telephone directory of the selected handset will be deleted. Continue?** with **OK**.

This deletes all the entries in the directory, including the entries for online directories.

### Please note:

For how to delete the directory on the handset, see page 43.

## Directory content (vcf file)

---

The following data (if available) is written into the vcf file for entry into the directory or transferred from a vcf file into the handset directory.

1. Name
2. First name
3. Number
4. Number (office)
5. Number (mobile)
6. E-mail address
7. Date (YYYY-MM-DD) and time of the reminder call (HH:MM) separated by a "T" (example: 2008-01-22T11:00).
8. Identification as VIP (X-SIEMENS-VIP:1)

Other information that a vCard may contain is not entered into the handset directory.

### Example for an entry in vCard format:

```
BEGIN:VCARD
VERSION:2.1
N:Smith;Anna
TEL;HOME:1234567890
TEL;WORK:0299123456
TEL;CELL:0175987654321
EMAIL:anna@smith.com
BDAY:1975-05-04T11:00
X-SIEMENS-VIP:1
END:VCARD
```

## Activating VoIP status message display

---

You can display VoIP status messages on your handset when there are VoIP connection problems. These messages give you information on the status of a connection and contain a provider-specific status code that helps the service team when they are analysing the problem.

- ▶ Open the following Web page: **Settings** → **Handsets**.  
The settings are carried out in the **Miscellaneous** area.
- ▶ Click the **Yes** option next to **Show VoIP status on handset** to activate the status message display.  
If you click **No**, no VoIP status messages are displayed.
- ▶ Click **Set** to save the changes.

### Please note:

A table with possible status codes and their meaning can be found in the appendix on page 140.

## Starting a firmware update

---

If necessary, you can load updates of the base station firmware onto your phone.

The server on which Siemens makes new firmware versions available for your base station is set by default. The URL of the Internet server is displayed in the **Data server** field.

You should only change this URL under exceptional circumstances (e.g. if requested to do so due to erroneous behaviour). This address is also used to load provider information from the Internet. You should therefore make a note of the default URL before you overwrite it. Otherwise, you will only be able to reactivate the default URL by resetting the base station back to the default settings (page 96).

### Please note:

- When updating from the Internet, checks are made to ensure that no **newer** version of the firmware exists. If this is not the case, the operation is terminated.
- The firmware is only loaded from the Internet if you have not entered a local file in the **User defined firmware file** field prior to the update.

### Preconditions:

- ◆ No calls are being made via the fixed line network or VoIP.
- ◆ There is no internal connection between registered handsets.
- ◆ The base station menu is not open in any of the handsets.
- ▶ Open the following Web page: **Settings**  
→ **Miscellaneous**.
- ▶ Click **Update Firmware**.

The firmware is updated. This process can take up to 3 minutes.

### Please note:

You can also start the firmware update on the handset (page 98).

### Firmware update from local firmware file

In exceptional circumstances you may receive, for example, a firmware file from Service that you can upload from your PC to your telephone (e.g. because the firmware update via the Internet did not work).

**Precondition:** A Web server is running on the local PC (e.g. Apache).

- ▶ First load the firmware file onto your PC.
- ▶ In the **User defined firmware file** field enter the IP address of the PC in your local network and then complete the path and name of the firmware file on the PC. Example: 192.168.2.105/C470IP/FW\_file.bin.
- ▶ Click **Set** to save the changes.
- ▶ Click the **Update Firmware** button to start the update.

This setting is automatically used for **this particular** firmware update. The URL in the **Data server** field is saved and used again for subsequent firmware updates. You will have to re-enter the IP address and file name if you need to carry out another firmware update on your local PC.

### Please note:

If an error arises during a firmware update from a local PC, the most recent version of the firmware is automatically downloaded from the Internet.

## Activating/deactivating the automatic version check

When the version check is activated, the phone checks on a daily basis whether the Siemens configuration server is carrying a new version of the phone firmware or of the file with the general settings for your VoIP provider.

If a new version is available, a notification is sent to the handset and the message key flashes. You can then carry out an automatic update of the firmware (page 99) or of the VoIP provider settings (page 100).

- ▶ Open the following Web page: **Settings** → **Miscellaneous**.
- ▶ Click the **Yes** option next to **Automatic check for software/profile updates** to activate the automatic version check.  
Click **No** if you do not want a version check to be carried out.
- ▶ Click **Set** to save the changes.

## Copying the date/time from time server

---

The date and time are shown in the idle display of registered handsets. They are important, for example, for stating the correct time in the calls list and for the "anniversary", "appointment" and "alarm clock" functions.

There are two methods for updating the time and date on your base station: manually with one of the registered handsets (page 11) or automatically by synchronisation with a time server on the Internet.

Activate/deactivate synchronisation with a time server as follows:

- ▶ Open the following Web page:  
**Settings** → **Miscellaneous**.
- ▶ In the **Automatic adjustment of System Time with Time Server** field select **Yes** to activate synchronisation between base station and a time server. If you select **No** the base station will not adopt time settings from a time server. In this case you should set the time and date manually using a handset.
- ▶ The **Last synchronisation with time server** field shows the last time when the base station compared time and date settings with a time server.
- ▶ In the **Time Server** field, enter the Internet address or name of the time server from which the base station should adopt its time and date settings. The time server "europe.pool.ntp.org" is set as default on the base station. You can overwrite the setting.
- ▶ From the **Country** list, select the country in which your base station is being operated.
- ▶ The **Time Zone** field shows the valid time zone for the **Country**. It shows the deviation between local time (not summer time) and Greenwich Mean Time (GMT).

If a country is divided into various time zones, they will all appear in the list. Select the appropriate **Time Zone** for the base station from the list.

- ▶ The **Automatically adjust clock to summer-time changes** field will be displayed if your time zone differentiates between summer time and winter time.

Activate **On** if you want the time to change automatically to summer time or winter time when summer time begins and ends respectively.

Activate **Off** if you do not want to change to summer time.

**Please note:** If the date and time are updated by a time server that automatically switches between summer time and standard time, you must always activate **Off** here.

- ▶ Click the **Set** button to save the settings in your phone.

Once you have activated synchronisation the base station will compare time and date with a time server as soon as an internet connection is established.

Synchronisation will usually occur once a day (at night) if synchronisation is activated. Any additional synchronisation will take place only after each new system start of the base station (e.g. after a firmware update or a power cut).

If you register a new handset on your base station it will assume the time and date of the base station without any additional synchronisation with the time server.

Date and time settings are transferred to every handset after synchronisation.

**Please note:**

- The default time server "europe.pool.ntp.org" will remain stored in the base station even if you overwrite it. If you delete your time server from the **Time Server** field and synchronisation is still activated, the base station will return to synchronisation with the default time server. However, it will no longer appear in the **Time Server** field.
- The base station will return to synchronisation with the default time server if you have entered your own time server in the **Time Server** field and the base station is unable to synchronise time and date for ten consecutive attempts.
- If you have deactivated synchronisation with a time server, and if the date and time are not set on any handset, then the base station will attempt to reference date and time settings from the CLIP information of an incoming call.

## Querying the phone status

---

General information about your phone is displayed.

- ▶ In the menu list, click the **Status** tab.

The following information is displayed:

### IP Configuration

#### IP address

The phone's current IP address within the local network. For assigning the IP address, see page 109.

#### MAC address

The phone's device address.

### Software

#### Firmware version

Version of the firmware currently downloaded. You can download updates of the firmware on your phone (page 98). Firmware updates are available on the Internet.

#### EEPROM version

Version of your phone's EEPROM storage chip (page 162).



# Appendix

---

## Care

---

- ▶ Wipe down the base station and handset with a **damp** cloth (no solvents) or an antistatic cloth.

**Never** use a dry cloth. This can cause static.

## Contact with liquid

---

If the handset should come into contact with liquid:

- ▶ **Switch the handset off and remove the batteries immediately.**
- ▶ Allow the liquid to drain from the handset.
- ▶ Pat all parts dry, then with the battery compartment open and the keypad facing down place the handset in a dry, warm place **for at least 72 hours** (not in a microwave, oven etc.).
- ▶ **Do not switch on the handset again until it is completely dry.**

When it has fully dried out, you will normally be able to use it again.

## Questions and answers

---

If you have any questions about using your phone, visit us at [www.siemens.com/gigasetcustomercare](http://www.siemens.com/gigasetcustomercare) at any time. The table below contains a list of common problems and possible solutions.

### Please note:

To support the service team, it can be helpful if you have the following information to hand:

- Version of firmware, EEPROM and your phone's MAC address  
You can check this information with the Web configurator (page 135). For how to display the MAC address on your handset, turn to page 102.
- VoIP status code (page 140)  
For problems with VoIP connections, you should set VoIP status messages to be displayed on your handset (page 100, page 132). These messages contain a status code that helps when the problem is analysed.

### Registration or connection problems with a Bluetooth headset.

- ▶ Reset the Bluetooth headset (see the user guide for your headset).
- ▶ Delete registration data from the handset when de-registering the device (see page 94).
- ▶ Repeat the registration process (see page 94).

### The display is blank.

1. The handset is not switched on.
  - ▶ Press **and hold** the end call key .
2. The battery is flat.
  - ▶ Charge the battery or replace it (page 10).

### The keys of a handset do not respond when pressed.

The keypad lock is activated.

- ▶ Press and **hold** the hash key  (page 31).

### "Base X" flashes on the display.

1. The handset is outside the range of the base station.
  - ▶ Move the handset closer to the base station.
2. The handset has been de-registered.
  - ▶ Register the handset (page 81).
3. The base station is not turned on.
  - ▶ Check the base station's mains adapter (page 13).
4. The base station firmware is currently being updated (page 98/page 132).
  - ▶ Please wait until the update is complete.

**"Base Search" flashes in the display.**

The handset is set to **Best Base** and no base station is turned on or within range.

- ▶ Move the handset closer to the base station.
- ▶ Check the base station mains adapter.

**Handset does not ring.**

1. The ringer tone is switched off.
  - ▶ Activate the ringer tone (page 89).
2. Call forwarding set to **All Calls**.
  - ▶ Deactivate call forwarding (fixed line network page 37; VoIP page 39/ page 121).

**You cannot hear a ringer/dialling tone from the fixed line network.**

Base station's phone cord has been replaced.

- ▶ When purchasing a new cord, ensure that it has the correct jack pin connections (page 14).

**Error tone sounds after system PIN prompt.**

You have entered the wrong system PIN.

- ▶ Enter system PIN if required.
- Have you forgotten the system PIN?
- ▶ Carry out a reset on the base station to set the system PIN back to 0000 (page 97).

**The other party cannot hear you.**

You have pressed the  (INT) key. The handset is "muted".

- ▶ Activate the microphone again (page 31).

**When making calls from the fixed line network, the caller's phone number is not displayed although CLIP (page 29) is set.**

Calling Line Identification is not enabled.

- ▶ The **caller** should ask his network provider to enable Calling Line Identification (CLI).

**You hear an error tone (descending tone sequence) when inputting.**

Action has failed/invalid input.

- ▶ Repeat the operation.  
Watch the display and refer to the user guide if necessary.

**You cannot connect to the router and the phone is assigned a static IP address.**

- ▶ Check on the router whether the IP address is already being used by another device in the LAN or belongs to the block of IP addresses that is reserved on the router for dynamic address assignment.
- ▶ If necessary, change the phone's IP address (page 101).

**You have made a call via VoIP but cannot hear the other caller.**

Your phone is connected to a router with NAT/firewall.

- ▶ Your STUN server (page 115) or outbound proxy (page 115) settings are incomplete or incorrect. Check the settings.
- ▶ No outbound proxy is entered or the outbound proxy mode **Never** is activated (page 115) and your phone is connected to a router with symmetric NAT or a blocking firewall.
- ▶ Port forwarding is activated on your router, but no permanent IP address has been assigned to your phone.

**You cannot make calls via VoIP. "Server not accessible!" is displayed.**

- ▶ First wait a few minutes. This is often a short-term event that corrects itself after a short time.

If the message is still displayed, proceed as follows:

- ▶ Check whether your phone's Ethernet cable is correctly connected to the router.
- ▶ Check your router's cable connection to the Internet.
- ▶ Check whether the phone is connected to the LAN. Send a ping command, e.g. from your PC, to the phone (ping  <local IP address of the phone>). It may be that no IP address could be assigned to the phone or a permanently set IP address is already assigned to another LAN subscriber. Check the settings on the router, you may have to activate the DHCP server.

**You cannot make calls via VoIP.** Either "Provider registration failed!" or "Registration failed" is shown.

- ▶ First wait a few minutes. This is often a short-term event that corrects itself after a short time.

The message may still be displayed for the following reasons:

1. The personal VoIP access data (**Username**, **Authent. Name** and **Authent. Password**) you have entered may be incomplete or wrong.
  - ▶ Check your information. In particular, check your use of upper and lower case.
2. The general settings for your VoIP provider are incomplete or incorrect (incorrect server address).
  - ▶ Start the Web configurator and check the settings.

**You cannot make calls via VoIP.** The display shows **IP configuration error: xxx** or **VoIP config.error: xxx** (xxx = VoIP status code).

You are trying to make a call via a VoIP connection that is not properly configured.

- ▶ Start the Web configurator and check the settings. Possible status codes and their meanings are listed on page 140.

**The phone does not dial an entered number.** The display shows **Not possible!**

The number may be blocked (dial rule).

- ▶ Open the **Dialling Plans** Web page of the Web configurator and delete or deactivate the block if necessary.

**You cannot establish a connection to the phone with your PC's Web browser.**

- ▶ When establishing a connection, check the phone's local IP address that has been entered. You can check the IP address on your handset.
- ▶ Check the LAN connections for the PC and phone.
- ▶ Check that your phone can be reached. Send a ping command, e.g. from your PC, to the phone (ping  $\square$  <local IP address of the phone>).
- ▶ You have tried to reach the phone via a secure http (https://...). Try again with http://....

**You cannot be reached for calls from the Internet.**

- ▶ There is no entry for your phone in your router's routing table. Check the settings for the **NAT refresh time** (page 115).
- ▶ Your phone is not registered with the VoIP provider.
- ▶ You have entered the wrong user ID or an incorrect domain (page 113).

**No firmware update or VoIP profile download is carried out.**

1. If **Currently not possible!** is displayed, the VoIP connections may be busy or a download/update is already being carried out.
  - ▶ Repeat the process at a later time.
2. If **File corrupted!** is displayed, the firmware or profile file may be invalid.
  - ▶ Please only use firmware and downloads that are made available on the pre-configured Siemens server (page 132) or at [www.siemens.com/qiqasetcus-tomercare](http://www.siemens.com/qiqasetcus-tomercare).
3. If **Server not accessible!** is displayed, the download server may not be accessible.
  - ▶ The server is currently not accessible. Repeat the process at a later time.
  - ▶ You have changed the preconfigured server address (page 132). Correct the address. If necessary, reset the base station.
4. If **Transmission Error XXX** is displayed, an error has occurred in the transmission of the file. An HTTP error code is displayed for XXX.
  - ▶ Repeat the process. If the error occurs again, consult the Service department.
5. If **Check IP settings!** is displayed, your phone may not be connected to the Internet.
  - ▶ Check the cable connections between the phone and router and between the router and the Internet.
  - ▶ Check whether the phone is connected to the LAN, i.e. it can be reached at its IP address.

**You cannot listen to or control a network mailbox.**

**VoIP:**

Your VoIP provider does not support the type of DTMF signalling set up on your phone.

- ▶ Ask your VoIP provider which signalling it supports and change the settings on your phone (page 122) if necessary.

Operating the base station within a PABX:

Your PABX is set for dial pulsing.

- ▶ Set your PABX to touch tone dialling.

**No time is specified for a message in the call history.**

Date/time is not set.

- ▶ Set date/time (page 11) or
- ▶ Activate base station synchronisation with a time server on the Internet (page 134).

**The integrated answer machine reports "Invalid PIN" on remote operation.**

1. You have entered the wrong system PIN.
  - ▶ Enter the system PIN again.
2. The system PIN is still set to 0000.
  - ▶ Change the system PIN (page 96).

**The integrated answer machine does not record messages/has switched to notification announcement.**

Its memory is full.

- ▶ Delete old messages.
- ▶ Play back new messages and delete.

**The integrated answer machine will not record a conversation or interrupts the two-way recording.**

1. An error tone sounds and the display shows **Not possible!**
  - ▶ You are making the call via a broadband VoIP connection. A recording is not possible in this case. The attempt by the base station to establish a non-broadband connection instead has failed (rearranging the codec).  
If necessary, you or the other caller must change the setting for the codec used (page 117).
2. The display shows **Delete messages**  
The answer machine's memory is full.
  - ▶ Use a different handset to delete messages from the answer machine and restart two-way recording.

Or:

  - ▶ Finish the call, delete old messages from the answer machine and re-establish the connection.

## VoIP status codes

If you have problems with your VoIP connections, activate the **Show Stat. on HS** function (page 100, page 132). You will then receive a VoIP status code that will support you in problem analysis. Also enter the code during problem analysis by the Service department.

In the following tables you will find the meanings of the most important status codes and messages.

Status code	Meaning
0x31	IP configuration error: IP domain not entered.
0x33	IP configuration error: SIP user name ( <b>Authentication Name</b> ) not entered. This is shown, for example, when dialling with a line suffix, if no connection is configured for the suffix on the base station.
0x34	IP configuration error: SIP password ( <b>Authentication password</b> ) not entered.
0x300	The called party can be reached under several phone numbers. If the VoIP provider supports this, a list of the phone numbers is transmitted as well as the status code. The caller can select to which number he wants to make the connection.
0x301	Permanently redirected. The called party can no longer be reached under this number. The new number is transmitted to the phone together with the status code, and the phone then no longer accesses the old number but dials the new address immediately.
0x302	Temporarily redirected. The phone is informed that the called party cannot be reached under the number dialled. The duration of redirecting is time-limited. The phone is also notified of the duration of redirecting.

Status code	Meaning
0x305	The query is sent to a different "proxy server", e.g. to balance out incoming queries. The phone will make the same query once again to another proxy server. This is not a redirection of the address per se.
0x380	Other service: The query or the call could not be made. But the phone is notified what other options there are to be able to connect the call.
0x400	Wrong call
0x401	Not authorised
0x403	The requested service is not supported by the VoIP provider.
0x404	Wrong phone number. No caller on this number. Example: In a local call you have not dialled the area code although your VoIP provider does not support local calls.
0x405	Method not permitted.
0x406	Not acceptable. The requested service cannot be provided.
0x407	Proxy authentication required.
0x408	The party cannot be reached (e.g. account has been deleted).
0x410	The requested service is not available from the VoIP provider.
0x413	Message is too long.
0x414	URI is too long.
0x415	Query format is not supported.
0x416	URI is faulty.
0x420	Incorrect ending
0x421	Incorrect ending
0x423	The requested service is not supported by the VoIP provider.
0x480	The dialled number is temporarily unavailable.
0x481	The recipient is not available.
0x482	Double service query

Status code	Meaning
0x483	Too many "hops": The query was rejected because the service server (proxy) has decided that this query has already passed through too many service servers. The maximum number was previously specified by the original sender of the query.
0x484	Wrong number: In most cases this response means that you have simply omitted one or more digits in the phone number.
0x485	The URI dialled is not unique and cannot be processed by the VoIP provider.
0x486	The called party is busy.
0x487	General faults: The call was interrupted before a call was established. The status code confirms receipt of the interruption signal.
0x488	The server cannot process the query because the data entered in the media description is not compatible.
0x491	The server notifies that the query will be processed as soon as a previous query has been completed.
0x493	The server rejects the query because the phone cannot decrypt the message. The sender has used an encryption method that neither the server nor the receiver phone can decrypt.
0x500	The proxy or the receiving device has discovered a fault while executing the query, which makes further execution of the query impossible. In this case, the caller or the phone displays the fault and repeats the query after a few seconds. The number of seconds after which the query can be repeated may be transmitted to the caller or phone by the receiving device.

Status code	Meaning
0x501	The query cannot be processed by the recipient because the recipient does not have the functionality that the caller requires. If the recipient understands the query but does not process it because the sender does not have the necessary rights or the query is not permitted in the current context, a 405 is sent instead of 501.
0x502	In this case, the receiving device that transmits this error code is a proxy or a gateway and has received an invalid response from its gateway via which this query is to be processed.
0x503	The query cannot currently be processed by the receiving device or the proxy because the server is either overloaded or is being serviced. If it is possible for the query to be repeated in the foreseeable future, the server informs the caller or the phone of this.
0x504	Time limit at the gateway
0x505	The server rejects the query because the indicated version number of the SIP protocol does not at least concur with the version that is used by server or the SIP device involved in this query.
0x515	The server rejects the query because the message exceeds the maximum permitted size.
0x600	The called party is busy.
0x603	The called party has rejected the call.
0x604	The called URI does not exist.
0x606	The communication settings are not acceptable.
0x701	The called party has hung up.
0x703	Connection interrupted because of time-out.
0x704	Connection interrupted because of a SIP error.
0x705	Wrong dialling tone
0x706	No connection established

Status code	Meaning
0x751	Busy tone: No codec match between the calling and called party.
0x810	General socket layer error: User is not authorised.
0x811	General socket layer error: Wrong socket number
0x812	General socket layer error: Socket is not connected.
0x813	General socket layer error: Memory error
0x814	General socket layer error: Socket not available – check IP settings/connection problem/VoIP setting incorrect.
0x815	General socket layer error: Illegal application on the socket interface.

## Checking service information

You may need the service information of your phone (base station and handset) for Customer Services.

### Base station service information

**Precondition:** You are conducting an external call. The connection has been established for at least 8 sec.

**Options** → **Service Info**

Confirm selection with **OK**.



The following information is displayed:

- 1: Serial number of the base station (RFPI)
- 2: Serial number of your handset (IPUI)
- 3: Informs the service employees of the base station settings (in hex diagram), e.g. the number of registered handsets, repeater mode. The last 4 digits indicate the number of operating hours (hexadecimal).
- 4: Variant, version of the firmware (digits 3 to 5).
- 5: Gigaset.net number of your phone. With this number you can call a service employee over the Internet without needing to be registered with a VoIP provider. This means that the employee can test online connections and VoIP telephony irrespective of the VoIP provider.

### Service information of the handset

In the handset idle status:

Open the menu by pressing 

- Press the following keys one after the other:     

The following information, among other details, is displayed on the handset:

- 1: Serial number (IPUI)
- 2: Number of operating hours
- 3: Variant, version of handset software

## Service (Customer Care)

---

We offer you support that is fast and tailored to your specific needs!

Our Online Support on the Internet can be reached any time from anywhere.

<http://www.siemens.com/gigasetcustomercare>

It provides you with 24/7 support for all our products. It also provides a list of FAQs and answers plus user guides and current software updates (if available for the product) for you to download.

You will also find frequently asked questions and answers in the appendix of this user guide.

For personal advice on our range of products and assistance with repairs or guarantee/warranty claims you can contact us on:

UK helpdesk: 0 84 53 67 08 12.

Please have your proof of purchase ready when calling with regard to guarantee/warranty claims.

Replacement or repair services are not offered in countries where our product is not sold by authorised dealers.

Please address any questions about DSL access and VoIP access to the respective service provider.

## Authorisation

---

This device is intended for analogue phone lines in the UK.

Voice over IP telephony is possible via the LAN interface if an additional modem has been connected.

Country-specific requirements have been taken into consideration.

We, Siemens Home and Office Communication Devices GmbH & Co. KG, declare that this device meets the essential requirements and other relevant regulations laid down in Directive 1999/5/EC.

A copy of the 1999/5/EC Declaration of Conformity is available at this Internet address:

<http://www.siemens.com/gigasetdocs>.

**CE 0682**

### Bluetooth Qualified Design Identity

The Bluetooth QD ID for your Gigaset S68H is: B012741.



## Guarantee Certificate United Kingdom

---

Without prejudice to any claim the user (customer) may have in relation to the dealer or retailer, the customer shall be granted a manufacturer's Guarantee under the conditions set out below:

- ◆ In the case of new devices and their components exhibiting defects resulting from manufacturing and/or material faults within 24 months of purchase, Siemens shall, at its own option and free of charge, either replace the device with another device reflecting the current state of the art, or repair the said device. In respect of parts subject to wear and tear (including but not limited to, batteries, keypads, casing), this warranty shall be valid for six months from the date of purchase.
- ◆ This Guarantee shall be invalid if the device defect is attributable to improper treatment and/or failure to comply with information contained in the user guides.
- ◆ This Guarantee shall not apply to or extend to services performed by the authorised dealer or the customer themselves (e. g. installation, configuration, software downloads). User guides and any software supplied on a separate data medium shall be excluded from the Guarantee.
- ◆ The purchase receipt, together with the date of purchase, shall be required as evidence for invoking the Guarantee. Claims under the Guarantee must be submitted within two months of the Guarantee default becoming evident.

- ◆ Ownership of devices or components replaced by and returned to Siemens shall vest in Siemens.
- ◆ This Guarantee shall apply to new devices purchased in the European Union. For Products sold in the United Kingdom the Guarantee is issued by: Siemens Home and Office Communication Devices GmbH & Co. KG, Schlavenhorst 66, D-46395 Bocholt, Germany.
- ◆ Any other claims resulting out of or in connection with the device shall be excluded from this Guarantee. Nothing in this Guarantee shall attempt to limit or exclude a Customers Statutory Rights, nor the manufacturer's liability for death or personal injury resulting from its negligence.
- ◆ The duration of the Guarantee shall not be extended by services rendered under the terms of the Guarantee.
- ◆ Insofar as no Guarantee default exists, Siemens reserves the right to charge the customer for replacement or repair.
- ◆ The above provisions does not imply a change in the burden of proof to the detriment of the customer.

To invoke this Guarantee, please contact the Siemens telephone service. The relevant number is to be found in the accompanying user guide.

## Specifications

### Recommended batteries

Technology: Nickel-metal-hydride (NiMH)  
 Size: AAA (Micro, HR03)  
 Voltage: 1.2 V  
 Capacity: 600 – 1200 mAh

We recommend the following battery types, because these are the only ones that guarantee the specified operating times, full functionality and long service life:

- ◆ Sanyo NiMH 800
- ◆ GP 850 mAh
- ◆ Yuasa Technologies AAA 800

The device is supplied with two recommended batteries.

### Handset operating times/charging times

The operating time of your Gigaset depends on the capacity and age of the batteries and the way they are used. (All times are maximum possible times and apply when the display backlight is switched off).

	Capacity (mAh)			
	600	800	1000	1200
Standby time (hours)	130	175	220	265
Talktime (hours)	7	10	12	14
Operating time for 1.5 hrs of calls per day (hours)	70	90	115	135
Charging time, base station (hours)	6	9	11	13
Charging time, charging cradle (hours)	5	7	8	10

At the time of going to print, batteries up to 900 mAh were available and had been tested in the system. Due to the constant progression in battery development, the list of recommended batteries in the FAQ section of the Gigaset Customer Care pages is regularly updated:

[www.siemens.com/gigasetcustomercare](http://www.siemens.com/gigasetcustomercare)

### Base station power consumption

The power consumption for the base station is approx. 1.3 watt.

### General specifications

Interfaces	Fixed line network, Ethernet
No. of channels	60 duplex channels
Radio frequency range	1880 – 1900 MHz
Duplex method	Time multiplex, 10 ms frame length
Channel grid	1728 kHz
Bit rate	1152 kbit/s
Modulation	GFSK
Language code	32 kbit/s
Transmission power	10 mW, average power per channel
Range	up to 300 m outdoors, up to 50 m indoors
Base station power supply	230 V ~/50 Hz
Environmental conditions in operation	+5°C to +45°C; 20% to 75% relative humidity
Codecs	G.711, G.726, G.729AB with VAD/CNG, G.722
Quality of Service	TOS, DiffServ
Protocols	DECT, GAP, SIP, RTP, DHCP, NAT Traversal (STUN), HTTP

## Icons

This section explains the meaning of certain icons and typographical conventions that are used in this user guide.

### Copy Entry / Copy List (example)

Select one of the two specified menu functions.



**Save**

Enter digits or letters.

The display keys' current functions are shown reverse highlighted in the bottom display line. Press the display key below to launch the function.



Press the control key at the top or bottom: scroll up or down.



Press the control key on the right or left: e.g. select setting.







 etc.

Press the matching key on the handset.

## Example of a menu input

The steps you need to perform are shown in abbreviated form in the user guide. This is illustrated below using the example of "Setting the contrast for the display". The things you have to do are explained in the boxes.

 →  → Display

- ▶ With the handset in idle status, press on the right of the control key to open the main menu.
- ▶ Use the control key to select the icon  (**Settings**) – to do this, press up, down, right and left  /  on the control key until the icon has been selected.

**Settings** appears in the display header.

- ▶ Press the display key **OK** to confirm the selection.

The **Settings** submenu is displayed.

- ▶ Press up or down on the control key repeatedly until the **Display** menu function is selected.
- ▶ Press the display key **OK** to confirm the selection.

**Contrast** Select and press **OK**.

- ▶ Press down on the control key repeatedly until the **Contrast** menu function is selected.
- ▶ Press the display key **OK** or on the right of the control key to confirm your selection.



Select contrast.

- ▶ Press on the right or left of the control key to set the contrast.

**Save**

Press the display key.

- ▶ Press the display key **Save** or on the right of the control key to save the setting.



Press and **hold** (idle status).

- ▶ Press and hold the end call key until the handset returns to idle status.

## Example of multiple line input

In many situations you can change settings or enter data in several lines of a display.

In this user guide, icons are used to guide you step by step through multiple line input. This is illustrated below using the example of "Setting the date and time". The things you have to do are explained in the boxes.

To change the time, open the input field with:

 →  → Date/Time

You will see the following in the display (example):

**Date/Time**

---

**Date:**  
[15.01.2008]

**Time:**  
11:11

 **Save**

### Date:

Enter the day, month and year in 8-digit format.

The second line is marked with [ ] to show it is active.

- ▶ Enter the date using the digit keys.

### Time:

Enter hours/minutes in 4-digit format.

- ▶ Press the  key.

The fourth line is marked with [ ] to show it is active.

- ▶ Enter the date using the digit keys.

- ▶ Save the changes.





- ▶ Press the display key **Save**.
- ▶ Then press and **hold** the  key. The handset switches to idle status.

Or:

- ▶ Press the display key **Options**.
- ▶ Select **Save** and then press the display key **OK**.
- ▶ Then press and **hold** the  key. The handset switches to idle status.

## Writing and editing text

The following rules apply when writing text:





- ◆ Control the cursor with    .
- ◆ Characters are inserted to the left of the cursor.
- ◆ Press the star key  to display the table of special characters (see below "Entering special characters".)
- ◆ The first letter of the name of directory entries is automatically capitalised, followed by lower case letters.

### Entering special characters

- ▶ Press the star key .

A table is opened containing all the special characters. The cursor is positioned on the character "." (full stop).

␣	_	!	?	@	,	'	"	¤
(	)	;	:	█	-	+	&	%
*	=	<	>	/	€	£	\$	¥
[	]	\$	←	↘	~	^	¿	¡
{	}	#						

- ▶ Navigate to the required character with the control key  . Example: to select \* press 4 x  and 1 x .
- ▶ Press the display key **Insert**. The character is inserted into the text. Pressing  again closes the table without inserting a character.

## Writing a text/name (without predictive text)

Press the relevant key several times to enter letters/characters.

### Standard characters

	1x	2x	3x	4x	5x	6x	7x	8x	9x	10x
1 sp	␣ <sup>1)</sup>	␣ <sup>2)</sup>	1							
2 abc	a	b	c	2	ä	á	à	â	ã	ç
3 def	d	e	f	3	ë	é	è	ê		
4 ghi	g	h	i	4	ï	í	ì	î		
5 jkl	j	k	l	5						
6 mno	m	n	o	6	ö	ñ	ó	ò	ô	õ
7 pqr	p	q	r	s	7	ß				
8 tuv	t	u	v	8	ü	ú	ù	û		
9 wxyz	w	x	y	z	9	ÿ	ý	æ	ø	å
0 +	.	,	?	!	0					

- 1) Space
- 2) Line break

When you press and **hold** a key, the characters of the corresponding key are displayed in the **bottom display line** and marked one after another. When you release the key the highlighted character is inserted into the input field.

### Setting upper/lower case or digits

Press and **hold** the hash key (#↔) before entering the character to switch from "Abc" mode to "123", from "123" to "abc" and from "abc" to "Abc" (upper case: 1st letter upper case, all others lower case).

The display shows whether upper case, lower case or digits is selected. The bottom right of the display (above the right display key) shows "Abc", "abc" or "123".

## Writing a text/name (with predictive text)

The EATONI predictive text function helps you when you are writing messenger messages and SMS.

Each key between [0+] and [9 wxyz] is assigned several letters and characters (see special characters, page 147). These appear in a selection line immediately under the text panel (over the display keys) as soon as you press a key. The letter you are most likely looking for is shown in reversed highlights and is at the beginning of the selection line. It is copied into the text panel.

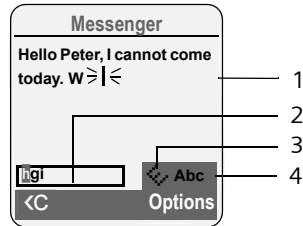

- 1 SMS text
- 2 Selection line
- 3 EATONI is activated
- 4 Upper/lower case or digits

If this letter is the one you want, confirm it by pressing the next key. If it does not match the one you want, press the hash key (#↔) **briefly** until the letter you are looking for is reverse highlighted in the display line and then transferred to the text field.

If you press and **hold** the hash key (#↔) you switch from "Abc" mode to "123" and from "123" to "abc" and from "abc" to "Abc".

## Deactivating/activating predictive text

- ▶ You are writing an SMS (page 54) or a Messenger message (page 76).

**Options** / 

Press the display key.

### Predictive Text

Select and press **OK** ( = on).



Press the end call key **briefly** to return to the text field.  
Enter the text.

## Setting input language

- ▶ You are writing an SMS (page 54) or a Messenger message (page 76).

**Options** / 

Press the display key.

### Select Language

Select and press **OK**.



Select input language and press **OK**.



Press the end call key **briefly** twice to return to the input field.

The input language setting only applies to the current message/SMS.

## Order of directory entries

Directory entries are generally sorted alphabetically by surname. Spaces and digits take first priority. If only the first name was entered in the directory, this is incorporated into the sort order instead of the surname.

The sort order is as follows:

1. Space
2. Digits (0–9)
3. Letters (alphabetical)
4. Other characters

To get round the alphabetical order of the entries, insert a space or a digit in front of the first letter of the surname. These entries will then move to the beginning of the directory. Names that you have prefixed with a star will move to the end of the directory.

## Additional functions via the PC interface

You can connect your Gigaset S68H handset to your computer using Bluetooth (page 93). The computer must be equipped with a suitable dongle.

Your handset can communicate with the computer using the **Gigaset QuickSync** program (free download at [www.siemens.com/gigasetS670](http://www.siemens.com/gigasetS670)).

You can

- ◆ access your handset's directory and synchronise it with Outlook, or copy contact details to the handset,
- ◆ download CLIP pictures (.bmp) from the computer to the handset,
- ◆ download pictures (.bmp) for the screensaver from the computer to the handset.

During the transfer of data between handset and PC, you will see **Data transfer in progress** on the display. During this time the keypad is disabled, and incoming calls will be ignored.

## Gigaset S685/S675 IP – free software

---

Your Gigaset S685/S675 IP's firmware includes free software that is licensed under the GNU Lesser General Public License. This free software was developed by a third party and is protected by copyright. You will find the licence text in its original English version on the pages that follow.

The software is provided free of charge. You are authorised to use this free software in accordance with the above-mentioned licence conditions. In the event of contradictions between these licence conditions and the licence conditions that apply for the software according to Siemens Home and Office Communication Devices GmbH & Co. KG, the above-mentioned licence conditions shall take precedence for the free software.

The GNU Lesser General Public License (LGPL) is supplied with this product. You can also download the licence conditions from the Internet:

- ◆ The **LGPL** is available on the Internet at: <http://www.gnu.org/copyleft/lesser.html>
- ◆ The **source text, including copyright notices for free software**, is currently available on the Internet at: <http://www.siemens.com/gigaset/developer>

For more information and Internet links to the source text of the free software, see the Online Support pages on the Internet at:

[www.siemens.com/gigasetcustomer-care](http://www.siemens.com/gigasetcustomer-care)

If it is not already supplied with the product, you can request the source text, including copyright notices, from Siemens. There is a charge to cover the cost of copying and postage. Please submit this request by e-mail or fax to the following address or fax number within 3 years of purchasing this product. Please state the exact device type plus the version number of the installed device software.

Small Parts Dispatch Com Bocholt

E-mail: [kleinteileversand.com@siemens.com](mailto:kleinteileversand.com@siemens.com)

Fax: 0049 2871 / 91 30 29

Use of the free software contained in this product extending beyond the program sequence intended by Siemens is at the user's own risk – i.e. there shall be no claims for liability for defects against Siemens Home and Office Communication Devices GmbH & Co. KG. The GNU Lesser General Public License contains notes regarding the author's liability for defects or that of other proprietors of the free software.

You shall have no right to assert a claim against Siemens Home and Office Communication Devices GmbH & Co. KG based on liability for defects, if a defect in the product is or could be due to changes you have made to the programs or their configuration. Furthermore, you shall have no right to assert a claim against Siemens Home and Office Communication Devices GmbH & Co. KG based on liability for defects if the free software infringes the copyright of third parties.

Siemens shall not provide technical support for the software, including the free software included within it, if it has been changed.

## GNU LESSER GENERAL PUBLIC LICENSE

---

Version 2.1, February 1999

Copyright (C) 1991, 1999 Free Software Foundation, Inc., 59 Temple Place, Suite 330, Boston, MA 02111-1307 USA

Everyone is permitted to copy and distribute verbatim copies of this license document, but changing it is not allowed.

[This is the first released version of the Lesser GPL. It also counts as the successor of the GNU Library Public License, version 2, hence the version number 2.1.]

### Preamble

The licenses for most software are designed to take away your freedom to share and change it. By contrast, the GNU General Public Licenses are intended to guarantee your freedom to share and change free software--to make sure the software is free for all its users.

This license, the Lesser General Public License, applies to some specially designated software packages--typically libraries--of the Free Software Foundation and other authors who decide to use it. You can use it too, but we suggest you first think carefully about whether this license or the ordinary General Public License is the better strategy to use in any particular case, based on the explanations below.

When we speak of free software, we are referring to freedom of use, not price. Our General Public Licenses are designed to make sure that you have the freedom to distribute copies of free software (and charge for this service if you wish); that you receive source code or can get it if you want it; that you can change the software and use pieces of it in new free programs; and that you are informed that you can do these things.

To protect your rights, we need to make restrictions that forbid distributors to deny you these rights or to ask you to surrender these rights. These restrictions translate to certain responsibilities for you if you distribute copies of the library or if you modify it.

For example, if you distribute copies of the library, whether gratis or for a fee, you must give the recipients all the rights that we gave you. You must make sure that they, too, receive or can get the source code. If you link other code with the library, you must provide complete object files to the recipients, so that they can relink them with the library after making changes to the library and recompiling it. And you must show them these terms so they know their rights.

We protect your rights with a two-step method: (1) we copyright the library, and (2) we offer you this license, which gives you legal permission to copy, distribute and/or modify the library.

To protect each distributor, we want to make it very clear that there is no warranty for the free library. Also, if the library is modified by someone else and passed on, the recipients should know that what they have is not the original version, so that the original author's reputation will not be affected by problems that might be introduced by others.

Finally, software patents pose a constant threat to the existence of any free program. We wish to make sure that a company cannot effectively restrict the users of a free program by obtaining a restrictive license from a patent holder. Therefore, we insist that any patent license obtained for a version of the library must be consistent with the full freedom of use specified in this license.

Most GNU software, including some libraries, is covered by the ordinary GNU General Public License. This license, the GNU Lesser General Public License, applies to certain designated libraries, and is quite different from the ordinary General Public License. We use this license for certain libraries in order to permit linking those libraries into non-free programs.

When a program is linked with a library, whether statically or using a shared library, the combination of the two is legally speaking a combined work, a derivative of the original library. The ordinary General Public License therefore permits such linking only if the entire combination fits its criteria of freedom. The Lesser General Public License permits more lax criteria for linking other code with the library.

We call this license the "Lesser" General Public License because it does Less to protect the user's freedom than the ordinary General Public License. It also provides other free software developers Less of an advantage over competing non-free programs. These disadvantages are the reason we use the ordinary General Public License for many libraries. However, the Lesser license provides advantages in certain special circumstances.

For example, on rare occasions, there may be a special need to encourage the widest possible use of a certain library, so that it becomes a de-facto standard. To achieve this, non-free programs must be allowed to use the library. A more frequent case is that a free library does the same job as widely used non-free libraries. In this case, there is little to gain by limiting the



free library to free software only, so we use the Lesser General Public License.

In other cases, permission to use a particular library in non-free programs enables a greater number of people to use a large body of free software. For example, permission to use the GNU C Library in non-free programs enables many more people to use the whole GNU operating system, as well as its variant, the GNU/Linux operating system.

Although the Lesser General Public License is less protective of the users' freedom, it does ensure that the user of a program that is linked with the Library has the freedom and the wherewithal to run that program using a modified version of the Library.

The precise terms and conditions for copying, distribution and modification follow. Pay close attention to the difference between a "work based on the library" and a "work that uses the library". The former contains code derived from the library, whereas the latter must be combined with the library in order to run.

### **GNU LESSER GENERAL PUBLIC LICENSE TERMS AND CONDITIONS FOR COPYING, DISTRIBUTION AND MODIFICATION**

**0.** This License Agreement applies to any software library or other program which contains a notice placed by the copyright holder or other authorized party saying it may be distributed under the terms of this Lesser General Public License (also called "this License"). Each licensee is addressed as "you".

A "library" means a collection of software functions and/or data prepared so as to be conveniently linked with application programs (which use some of those functions and data) to form executables.

The "Library", below, refers to any such software library or work which has been distributed under these terms. A "work based on the Library" means either the Library or any derivative work under copyright law: that is to say, a work containing the Library or a portion of it, either verbatim or with modifications and/or translated straightforwardly into another language. (Hereinafter, translation is included without limitation in the term "modification".)

"Source code" for a work means the preferred form of the work for making modifications to it. For a library, complete source code means all the source code for all modules it contains, plus any associated interface definition files, plus the scripts used to control compilation and installation of the library.

Activities other than copying, distribution and modification are not covered by this License; they are outside its scope. The act of running a program using the Library is not restricted, and output from such a program is covered only if its contents constitute a work based on the Library (independent of the use of the Library in a tool for writing it). Whether that is true depends on what the Library does and what the program that uses the Library does.

**1.** You may copy and distribute verbatim copies of the Library's complete source code as you receive it, in any medium, provided that you conspicuously and appropriately publish on each copy an appropriate copyright notice and disclaimer of warranty; keep intact all the notices that refer to this License and to the absence of any warranty; and distribute a copy of this License along with the Library.

You may charge a fee for the physical act of transferring a copy, and you may at your option offer warranty protection in exchange for a fee.

**2.** You may modify your copy or copies of the Library or any portion of it, thus forming a work based on the Library, and copy and distribute such modifications or work under the terms of Section 1 above, provided that you also meet all of these conditions:

a) The modified work must itself be a software library.

b) You must cause the files modified to carry prominent notices stating that you changed the files and the date of any change.

c) You must cause the whole of the work to be licensed at no charge to all third parties under the terms of this License.

d) If a facility in the modified Library refers to a function or a table of data to be supplied by an application program that uses the facility, other than as an argument passed when the facility is invoked, then you must make a good faith effort to ensure that, in the event an application does not supply such function or table, the facility still operates, and performs whatever part of its purpose remains meaningful.

(For example, a function in a library to compute square roots has a purpose that is entirely well-defined independent of the application. Therefore, Subsection 2d requires that any application-supplied function or table used by this function must be optional: if the application does not supply it, the square root function must still compute square roots.)

These requirements apply to the modified work as a whole. If identifiable sections of that work are not derived from the Library, and can be reasonably considered independent and sepa-

rate works in themselves, then this License, and its terms, do not apply to those sections when you distribute them as separate works. But when you distribute the same sections as part of a whole which is a work based on the Library, the distribution of the whole must be on the terms of this License, whose permissions for other licensees extend to the entire whole, and thus to each and every part regardless of who wrote it.

Thus, it is not the intent of this section to claim rights or contest your rights to work written entirely by you; rather, the intent is to exercise the right to control the distribution of derivative or collective works based on the Library.

In addition, mere aggregation of another work not based on the Library with the Library (or with a work based on the Library) on a volume of a storage or distribution medium does not bring the other work under the scope of this License.

**3.** You may opt to apply the terms of the ordinary GNU General Public License instead of this License to a given copy of the Library. To do this, you must alter all the notices that refer to this License, so that they refer to the ordinary GNU General Public License, version 2, instead of to this License. (If a newer version than version 2 of the ordinary GNU General Public License has appeared, then you can specify that version instead if you wish.) Do not make any other change in these notices.

Once this change is made in a given copy, it is irreversible for that copy, so the ordinary GNU General Public License applies to all subsequent copies and derivative works made from that copy.

This option is useful when you wish to copy part of the code of the Library into a program that is not a library.

**4.** You may copy and distribute the Library (or a portion or derivative of it, under Section 2) in object code or executable form under the terms of Sections 1 and 2 above provided that you accompany it with the complete corresponding machine-readable source code, which must be distributed under the terms of Sections 1 and 2 above on a medium customarily used for software interchange.

If distribution of object code is made by offering access to copy from a designated place, then offering equivalent access to copy the source code from the same place satisfies the requirement to distribute the source code, even though third parties are not compelled to copy the source along with the object code.

**5.** A program that contains no derivative of any portion of the Library, but is designed to work with the Library by being compiled or linked with it, is called a "work that uses the Library". Such a work, in isolation, is not a derivative work of the Library, and therefore falls outside the scope of this License.

However, linking a "work that uses the Library" with the Library creates an executable that is a derivative of the Library (because it contains portions of the Library), rather than a "work that uses the library". The executable is therefore covered by this License.

Section 6 states terms for distribution of such executables.

When a "work that uses the Library" uses material from a header file that is part of the Library, the object code for the work may be a derivative work of the Library even though the source code is not.

Whether this is true is especially significant if the work can be linked without the Library, or if the work is itself a library. The threshold for this to be true is not precisely defined by law.

If such an object file uses only numerical parameters, data structure layouts and accessors, and small macros and small inline functions (ten lines or less in length), then the use of the object file is unrestricted, regardless of whether it is legally a derivative work. (Executables containing this object code plus portions of the Library will still fall under Section 6.)

Otherwise, if the work is a derivative of the Library, you may distribute the object code for the work under the terms of Section 6.

Any executables containing that work also fall under Section 6, whether or not they are linked directly with the Library itself.

**6.** As an exception to the Sections above, you may also combine or link a "work that uses the Library" with the Library to produce a work containing portions of the Library, and distribute that work under terms of your choice, provided that the terms permit modification of the work for the customer's own use and reverse engineering for debugging such modifications.

You must give prominent notice with each copy of the work that the Library is used in it and that the Library and its use are covered by this License. You must supply a copy of this License. If the work during execution displays copyright notices, you must include the copyright notice for the Library among them, as well as a reference directing the user to the copy of this License. Also, you must do one of these things:

- a) Accompany the work with the complete corresponding machine-readable source code for

the Library including whatever changes were used in the work (which must be distributed under Sections 1 and 2 above); and, if the work is an executable linked with the Library, with the complete machine-readable "work that uses the Library", as object code and/or source code, so that the user can modify the Library and then relink to produce a modified executable containing the modified Library. (It is understood that the user who changes the contents of definitions files in the Library will not necessarily be able to recompile the application to use the modified definitions.)

b) Use a suitable shared library mechanism for linking with the Library. A suitable mechanism is one that (1) uses at run time a copy of the library already present on the user's computer system, rather than copying library functions into the executable, and (2) will operate properly with a modified version of the library, if the user installs one, as long as the modified version is interface-compatible with the version that the work was made with.

c) Accompany the work with a written offer, valid for at least three years, to give the same user the materials specified in Subsection 6a, above, for a charge no more than the cost of performing this distribution.

d) If distribution of the work is made by offering access to copy from a designated place, offer equivalent access to copy the above specified materials from the same place.

e) Verify that the user has already received a copy of these materials or that you have already sent this user a copy.

For an executable, the required form of the "work that uses the Library" must include any data and utility programs needed for reproducing the executable from it. However, as a special exception, the materials to be distributed need not include anything that is normally distributed (in either source or binary form) with the major components (compiler, kernel, and so on) of the operating system on which the executable runs, unless that component itself accompanies the executable.

It may happen that this requirement contradicts the license restrictions of other proprietary libraries that do not normally accompany the operating system. Such a contradiction means you cannot use both them and the Library together in an executable that you distribute.

7. You may place library facilities that are a work based on the Library side-by-side in a single library together with other library facilities not covered by this License, and distribute such a combined library, provided that the separate

distribution of the work based on the Library and of the other library facilities is otherwise permitted, and provided that you do these two things:

a) Accompany the combined library with a copy of the same work based on the Library, uncombined with any other library facilities. This must be distributed under the terms of the Sections above.

b) Give prominent notice with the combined library of the fact that part of it is a work based on the Library, and explaining where to find the accompanying uncombined form of the same work.

8. You may not copy, modify, sublicense, link with, or distribute the Library except as expressly provided under this License. Any attempt otherwise to copy, modify, sublicense, link with, or distribute the Library is void, and will automatically terminate your rights under this License. However, parties who have received copies, or rights, from you under this License will not have their licenses terminated so long as such parties remain in full compliance.

9. You are not required to accept this License, since you have not signed it. However, nothing else grants you permission to modify or distribute the Library or its derivative works. These actions are prohibited by law if you do not accept this License. Therefore, by modifying or distributing the Library (or any work based on the Library), you indicate your acceptance of this License to do so, and all its terms and conditions for copying, distributing or modifying the Library or works based on it.

10. Each time you redistribute the Library (or any work based on the Library), the recipient automatically receives a license from the original licensor to copy, distribute, link with or modify the Library subject to these terms and conditions. You may not impose any further restrictions on the recipients' exercise of the rights granted herein.

You are not responsible for enforcing compliance by third parties with this License.

11. If, as a consequence of a court judgment or allegation of patent infringement or for any other reason (not limited to patent issues), conditions are imposed on you (whether by court order, agreement or otherwise) that contradict the conditions of this License, they do not excuse you from the conditions of this License. If you cannot distribute so as to satisfy simultaneously your obligations under this License and any other pertinent obligations, then as a consequence you may not distribute the Library at

all. For example, if a patent license would not permit royalty-free redistribution of the Library by all those who receive copies directly or indirectly through you, then the only way you could satisfy both it and this License would be to refrain entirely from distribution of the Library. If any portion of this section is held invalid or unenforceable under any particular circumstance, the balance of the section is intended to apply, and the section as a whole is intended to apply in other circumstances.

It is not the purpose of this section to induce you to infringe any patents or other property right claims or to contest validity of any such claims; this section has the sole purpose of protecting the integrity of the free software distribution system which is implemented by public license practices. Many people have made generous contributions to the wide range of software distributed through that system in reliance on consistent application of that system; it is up to the author/donor to decide if he or she is willing to distribute software through any other system and a licensee cannot impose that choice.

This section is intended to make thoroughly clear what is believed to be a consequence of the rest of this License.

**12.** If the distribution and/or use of the Library is restricted in certain countries either by patents or by copyrighted interfaces, the original copyright holder who places the Library under this License may add an explicit geographical distribution limitation excluding those countries, so that distribution is permitted only in or among countries not thus excluded. In such case, this License incorporates the limitation as if written in the body of this License.

**13.** The Free Software Foundation may publish revised and/or new versions of the Lesser General Public License from time to time. Such new versions will be similar in spirit to the present version, but may differ in detail to address new problems or concerns.

Each version is given a distinguishing version number. If the Library specifies a version number of this License which applies to it and "any later version", you have the option of following the terms and conditions either of that version or of any later version published by the Free Software Foundation. If the Library does not specify a license version number, you may choose any version ever published by the Free Software Foundation.

**14.** If you wish to incorporate parts of the Library into other free programs whose distribution conditions are incompatible with these,

write to the author to ask for permission. For software which is copyrighted by the Free Software Foundation, write to the Free Software Foundation; we sometimes make exceptions for this. Our decision will be guided by the two goals of preserving the free status of all derivatives of our free software and of promoting the sharing and reuse of software generally.

#### **NO WARRANTY**

**15.** BECAUSE THE LIBRARY IS LICENSED FREE OF CHARGE, THERE IS NO WARRANTY FOR THE LIBRARY, TO THE EXTENT PERMITTED BY APPLICABLE LAW.

EXCEPT WHEN OTHERWISE STATED IN WRITING THE COPYRIGHT HOLDERS AND/OR OTHER PARTIES PROVIDE THE LIBRARY "AS IS" WITHOUT WARRANTY OF ANY KIND, EITHER EXPRESSED OR IMPLIED, INCLUDING, BUT NOT LIMITED TO, THE IMPLIED WARRANTIES OF MERCHANTABILITY AND FITNESS FOR A PARTICULAR PURPOSE. THE ENTIRE RISK AS TO THE QUALITY AND PERFORMANCE OF THE LIBRARY IS WITH YOU. SHOULD THE LIBRARY PROVE DEFECTIVE, YOU ASSUME THE COST OF ALL NECESSARY SERVICING, REPAIR OR CORRECTION.

**16.** IN NO EVENT UNLESS REQUIRED BY APPLICABLE LAW OR AGREED TO IN WRITING WILL ANY COPYRIGHT HOLDER, OR ANY OTHER PARTY WHO MAY MODIFY AND/OR REDISTRIBUTE THE LIBRARY AS PERMITTED ABOVE, BE LIABLE TO YOU FOR DAMAGES, INCLUDING ANY GENERAL, SPECIAL, INCIDENTAL OR CONSEQUENTIAL DAMAGES ARISING OUT OF THE USE OR INABILITY TO USE THE LIBRARY (INCLUDING BUT NOT LIMITED TO LOSS OF DATA OR DATA BEING RENDERED INACCURATE OR LOSSES SUSTAINED BY YOU OR THIRD PARTIES OR A FAILURE OF THE LIBRARY TO OPERATE WITH ANY OTHER SOFTWARE), EVEN IF SUCH HOLDER OR OTHER PARTY HAS BEEN ADVISED OF THE POSSIBILITY OF SUCH DAMAGES.

#### **END OF TERMS AND CONDITIONS**

### How to Apply These Terms to Your New Libraries

If you develop a new library, and you want it to be of the greatest possible use to the public, we recommend making it free software that everyone can redistribute and change. You can do so by permitting redistribution under these terms (or, alternatively, under the terms of the ordinary General Public License).

To apply these terms, attach the following notices to the library. It is safest to attach them to the start of each source file to most effectively convey the exclusion of warranty; and each file should have at least the "copyright" line and a pointer to where the full notice is found.

```
<one line to give the library's name and a brief
idea of what it does.>
Copyright (C) <year> <name of author>
This library is free software; you can redistri-
bute it and/or modify it under the terms of the
GNU Lesser General Public License as publis-
hed by the Free Software Foundation; either
version 2.1 of the License, or (at your option)
any later version.
This library is distributed in the hope that it will
be useful, but WITHOUT ANY WARRANTY; wit-
hout even the implied warranty of MERCHAN-
TABILITY or FITNESS FOR A PARTICULAR PUR-
POSE. See the GNU Lesser General Public
License for more details.
```

You should have received a copy of the GNU Lesser General Public License along with this library; if not, write to the Free Software Foundation, Inc., 59 Temple Place, Suite 330, Boston, MA 02111-1307 USA

Also add information on how to contact you by electronic and paper mail.

You should also get your employer (if you work as a programmer) or your school, if any, to sign a "copyright disclaimer" for the library, if necessary. Here is a sample; alter the names:

```
Yoyodyne, Inc., hereby disclaims all copyright
interest in the library `Frob' (a library for twea-
king knobs) written by James Random Hacker.
<signature of Ty Coon>, 1 April 1990 Ty Coon,
President of Vice
```

## Accessories

---

### Gigaset handsets

Upgrade your Gigaset to a cordless PABX:

#### Gigaset S67H or S68H handset

- ◆ HDSP ready
- ◆ Illuminated graphical colour display (65k colours)
- ◆ Illuminated keypad
- ◆ Handsfree talking
- ◆ Polyphonic ringer tones
- ◆ Directory for around 250 entries
- ◆ Picture CLIP
- ◆ SMS (precondition: CLIP must be enabled)
- ◆ Headset socket
- ◆ Bluetooth (Gigaset S68H only)
- ◆ Room monitor

[www.siemens.com/gigasetS67H](http://www.siemens.com/gigasetS67H)

[www.siemens.com/gigasetS68H](http://www.siemens.com/gigasetS68H)



#### Gigaset SL37H handset

- ◆ HDSP ready
- ◆ Illuminated graphical colour display (65k colours)
- ◆ Illuminated keypad
- ◆ Handsfree talking
- ◆ Polyphonic ringer tones
- ◆ Directory for around 250 entries
- ◆ Picture CLIP
- ◆ SMS (precondition: CLIP must be enabled)
- ◆ PC interface e.g. for managing directory entries, ringer tones and screensavers
- ◆ Headset socket
- ◆ Bluetooth
- ◆ Room monitor
- ◆ Walky-talky function

[www.siemens.com/gigasetSL37H](http://www.siemens.com/gigasetSL37H)



## Accessories

### Gigaset S45 handset

- ◆ Illuminated colour display (4096 colours)
- ◆ Illuminated keypad
- ◆ Handsfree talking
- ◆ Polyphonic ringer tones
- ◆ Directory for around 150 entries
- ◆ SMS (precondition: CLIP must be enabled)
- ◆ Headset socket
- ◆ Room monitor

[www.siemens.com/gigaset](http://www.siemens.com/gigaset)



### Gigaset C47H handset

- ◆ Illuminated graphical colour display (65k colours)
- ◆ Illuminated keypad
- ◆ Handsfree talking
- ◆ Polyphonic ringer tones
- ◆ Directory for around 150 entries
- ◆ SMS (precondition: CLIP must be enabled)
- ◆ Headset socket
- ◆ Room monitor

[www.siemens.com/gigasetC47H](http://www.siemens.com/gigasetC47H)



### Gigaset repeater

The Gigaset repeater can be used to increase the reception range of your Gigaset handset to the base station.

[www.siemens.com/gigasetrepeater](http://www.siemens.com/gigasetrepeater)



### Gigaset HC450 – door intercom for cordless phones

- ◆ Use the intercom from your cordless phone – no need for a fixed home phone
- ◆ Intuitive user functions using the display keys (open door, switch on entry light)
- ◆ Simple to configure using the handset menu
- ◆ Forward to outside phone numbers (intercom feature)
- ◆ Simple to install and register with the Gigaset system
- ◆ Replaces existing call button – no further cable is needed
- ◆ Supports the existing doorbell and standard door opener
- ◆ Configuration options for the second ringer key (separate intercom call, activating interior lighting, or function such as first ringer key)

[www.siemens.com/GigasetHC450](http://www.siemens.com/GigasetHC450)



All accessories are available from your mobile phone retailer.



Only use original accessories. This will avoid possible health risks and damage to property, and also ensure that all the relevant regulations are complied with.



# Glossary

---

## A

### ADSL

Asymmetric Digital Subscriber Line  
Special form of **DSL**.

### ALG

Application Layer Gateway  
NAT control mechanism of a router.  
Many routers with integrated NAT use ALG. ALG lets the data packets in a VoIP connection pass and adds the public IP address of the secure private network. The router's ALG should be deactivated if the VoIP provider offers a STUN server or an outbound proxy.

See also: **Firewall, NAT, Outbound proxy, STUN**.

### Authentication

Restriction of access to a network/service by use of an ID and password to log in.

### Automatic ringback

See **Ringback when the number is busy**.

## B

### Block dialling

Enter the complete phone number, and correct it if necessary. Then pick up the receiver or press the handsfree key to dial the phone number.

### Broadband Internet access

See **DSL**.

### Buddy

Party with whom you exchange brief messages on the Internet in real time (chatting).

See also: **Instant messaging**.

## C

### Call forwarding

#### CF

Automatic forwarding of a call to a different telephone number. There are three kinds of call forwarding:

- CFU, Call Forwarding Unconditional
- CFB, Call Forwarding Busy
- CFNR, Call Forwarding No Reply

### Call waiting

#### CW

VoIP provider feature. A beep during a call indicates that another caller is waiting. You can accept or reject the second call. You can activate/deactivate the feature.

### Chatting

Form of communication on the Internet. During a chat, brief messages are exchanged between the communicating parties in real time. Chatting in this sense is understood to be a written form of communication.

### Client

Application that requests a service from a server.

### Codec

#### Coder/decoder

Codec is a procedure that digitises and compresses analogue voice before it is sent via the Internet and decodes – i.e. translates into analogue voice – digital data when voice packets are received. There are different codecs, with differing degrees of compression, for instance.

Both parties involved in the telephone connection (caller/sender and recipient) must use the same codec. This is negotiated between the sender and the recipient when establishing a connection.

The choice of codec is a compromise between voice quality, transmission speed and the necessary bandwidth. A high level of compression, for example, means that the bandwidth required for each voice connection is low. However, it also means that the time needed to compress/decompress the data is greater, which increases execution time for data in the network and thus impairs voice quality. The time required increases the delay between the sender speaking and the recipient hearing what has been said.

### COLP / COLR

Connected Line Identification Presentation/Restriction

Service characteristic of a VoIP connection for outgoing calls.

COLP displays the phone number accepting the call on the calling party's display unit.

The number of the party accepting the call is different to the dialled number, e.g. if the call is forwarded or transferred.

The called party can use COLR (Connected Line Identification Restriction) to prevent the number from appearing on the calling party's display.

### Consultation call

You are on a call. With a consultation call, you interrupt the conversation briefly to establish a connection to another participant. If you terminate the connection to this participant immediately, then this was then this was a consultation call. If you switch to and fro between the first and second participants, it is called **Toggleing**.

## D

### DHCP

Dynamic Host Configuration Protocol

Internet protocol that handles the automatic assignment of **IP addresses** to **Network subscribers**. The protocol is made available in the network by a server. A DHCP server can be a router for example.

The phone contains a DHCP client. A router that contains a DHCP server can assign the IP addresses for the phone automatically from a defined address block. The dynamic assignment means that several **Network subscribers** can share one IP address, although they use it alternately and not simultaneously.

With some routers you can specify that the IP address for the phone is never changed.

### Displayed name

VoIP provider feature. You can specify any name that is to be shown to the other party during a call instead of your phone number.

### DMZ (Demilitarised Zone)

DMZ describes a part of a network that is outside the firewall.

A DMZ is set up, as it were, between a network you want to protect (e.g. a LAN) and a non-secure network (e.g. the Internet). A DMZ permits unrestricted access from the Internet to only one or a few network components, while the other network components remain secure behind the firewall.

## Glossary

### DNS

Domain Name System

Hierarchical system that permits the assignment of **IP addresses** to **Domain names** that are easier to note. This assignment has to be managed by a local DNS server in each (W)LAN. The local DNS server determines the IP address, if necessary by enquiring about superordinate DNS servers and other local DNS servers on the Internet.

You can specify the IP address of the primary/secondary DNS server.

See also: **DynDNS**.

### Domain name

Name of one (of several) Web server(s) on the Internet (e.g. Siemens Home). The domain name is assigned to the relevant IP address by DNS.

### DSCP

Differentiated Service Code Point

See **Quality of Service (QoS)**.

### DSL

Digital Subscriber Line

Data transfer technology that allows Internet access with, for e.g. **1.5 Mbps** over a conventional telephone line. Preconditions: DSL modem and the appropriate service offered by the Internet provider.

### DSLAM

Digital Subscriber Line Access Multiplexer

The DSLAM is a switch cabinet in an exchange at which all subscriber connectors converge.

### DTMF

Dual Tone Multi-Frequency

Another description for dual tone multi-frequency dialling.

### Dynamic IP address

A dynamic IP address is assigned to a network component automatically via **DHCP**. The dynamic IP address for a network component can change every time it registers or at certain time intervals.

See also: **Static IP address**

### DynDNS

Dynamic DNS

Domain names and IP addresses are realised via **DNS**. For **Dynamic IP addresses** this service is now enhanced with "Dynamic DNS" (DynDNS). This permits the use of a network component with a dynamic IP address as a **Server** on the **Internet**. DynDNS ensures that a service can always be addressed on the Internet under the same **Domain name** irrespective of the current IP address.

## E

### ECT

Explicit Call Transfer

Participant A calls participant B. He puts the connection on hold and calls participant C. Rather than connect everyone in a three-party conference, A now transfers participant B to C and hangs up.

### EEPROM

Electrically Erasable Programmable Read Only Memory

Memory building block in your phone with fixed data (e.g. default and customised settings) and data saved automatically (e.g. entries to the list of callers).

### Ethernet network

Wired **LAN**.

## F

**Firewall**

You can use a firewall to protect your network against unauthorised external access. This involves combining various measures and technologies (hard and/or software) to control the flow of data between a private network you wish to protect and an unprotected network (e.g. the Internet).

See also: **NAT**.

**Firmware**

Device software in which basic information is saved for the functioning of a device. A new version of the firmware can be loaded into the device's memory (firmware update) to correct errors or update the device software.

**Flat rate**

Billing system for an **Internet** connection. The Internet provider charges a set monthly fee. There are no additional charges for the duration of the connection or number of connections.

**Fragmentation**

Data packets that are too big are split into smaller packets (fragments) before they are transferred. They are put together again when they reach the recipient (defragmented).

**Full duplex**

Data transmission mode in which data can be sent and received at the same time.

## G

**G.711 a law, G.711  $\mu$  law**

Standard for a **Codec**.

G.711 delivers a very good voice quality that corresponds to that in the ISDN fixed line. As there is little compression, the necessary bandwidth is around 64 kbit/s per voice connection, but the delay caused by coding/decoding is only 0.125 ms.

"a law" describes the European standard and " $\mu$  law" describes the North American/Japanese equivalent.

**G.722**

Standard for a **Codec**.

G.722 is a **broadband** language codec with a bandwidth of 50 Hz to 7 kHz, a net transfer rate of 64 kbit/s per language connection and integrated speech pause recognition and comfort noise generation (silence suppression).

G.722 delivers very good voice quality. A higher sampling rate provides clearer and better voice quality than other codecs and enables a speech tone in High Definition Sound Performance (HDSP).

**G.726**

Standard for a **Codec**.

G.726 delivers a good voice quality. It is inferior to the quality with codec **G.711** but better than with **G.729**.

**G.729A/B**

Standard for a **Codec**.

The voice quality is rather lower with G.729A/B. As a result of the high level of compression, the necessary bandwidth is only around 8 kbit/s per voice connection, but the delay is around 15 ms.

## Glossary

### Gateway

Connects two different **Networks**, e.g. a router as an Internet gateway.

For phone calls from **VoIP** to the telephone network, a gateway has to be connected to the IP network and the telephone network (gateway/VoIP provider). It forwards calls from VoIP to the telephone network as required.

### Gateway provider

See **SIP provider**.

### Global IP address

See **IP address**.

### GSM

Global System for Mobile Communication

Originally, European standard for mobile networks. GSM can now be described as a worldwide standard. In the USA and Japan national standards are now more frequently supported than in the past.

## H

### Headset

Combination of microphone and headphone. A headset makes handsfree talking more convenient. There are headsets available that are connected to the handset by a cable.

### HTTP proxy

Server via which the **Network subscribers** can process their Internet traffic.

### Hub

Uses one **Infrastructure network** to connect several **Network subscribers**. All data sent to the hub by one network subscriber is forwarded to all network subscribers.

See also: **Gateway, Router**.

## I

### IEEE

Institute of Electrical and Electronics Engineers

International body that defines standards in electronics and electrotechnology, concerned in particular with the standardisation of LAN technology, transmission protocols, data transfer rate and wiring.

### Infrastructure network

Network with central structure: all **Network subscribers** communicate via a central **Router**.

### Instant messaging

Service that uses a client program to allow chatting in real time, i.e. to send brief messages to other subscribers on the Internet.

### Internet

Global **WAN**. A series of protocols have been defined for exchanging data, known by the name TCP/IP.

All **Network subscribers** are identifiable via their **IP address**. **DNS** assigns a **Domain name** to the **IP address**.

Important services on the Internet include the World Wide Web (WWW), e-mail, file transfer and discussion forums.

### Internet Service Provider

Enables access to the Internet for a fee.

### IP (Internet Protocol)

TCP/IP protocol on the **Internet**. IP is responsible for addressing subscribers in a **Network** using **IP addresses** and routes data from the sender to the recipient. IP determines the paths (routing) along which the data packets travel.

**IP address**

A unique address for a network component within a network based on the TCP/IP protocols (e.g. LAN, Internet). On the **Internet**, domain names are usually assigned instead of IP addresses. **DNS** assigns the corresponding IP address to the domain name.

The IP address has four parts (decimal numbers between 0 and 255) separated by full stops (e.g. 230.94.233.2).

The IP address is made up of the network number and the number of the **Network subscribers** (e.g. phone). Depending on the Subnet mask, the front one, two or three parts make up the network number and the rest of the IP address addresses the network component. The network number of all the components in any one network must be identical.

IP addresses can be assigned automatically with DHCP (dynamic IP addresses) or manually (static IP addresses).

See also: **DHCP**.

**IP pool range**

Range of IP addresses that the DHCP server can use to assign dynamic IP addresses.

**L****LAN**

Local Area Network

Network with a restricted physical range. A LAN can be wireless (WLAN) and/or wired.

**Local IP address**

The local or private IP address is the address for a network component in the local network (LAN). The network operator can assign any address he or she wants. Devices that act as a link from a local network to the Internet (gateway or router) have a public and a private IP address.

See also **IP address**.

**Local SIP Port**

See **SIP port/Local SIP port**.

**M****MAC address**

Media Access Control Address

Hardware address by means of which each network device (e.g. network card, switch, phone) can be uniquely identified worldwide. It consists of 6 parts (hexadecimal numbers) separated by a "-" (e.g. 00-90-65-44-00-3A). The MAC address is assigned by the manufacturer and cannot be changed.

**Mbps**

Million bits per second

Unit of the transmission speed in a network.

**MRU**

Maximum Receive Unit

Defines the maximum user data volume within a data packet.

**MTU**

Maximum Transmission Unit

Defines the maximum length of a data packet that can be carried over the network at a time.

**Music on hold**

Music on hold

Music that is played while you are on a **Consultation call** or **Toggling**. The waiting participant hears music while on hold.

**N****NAT**

Network Address Translation

Method for converting (private) **IP addresses** to one or more (public) IP addresses. NAT enables the IP addresses of **Network subscribers** (e.g. VoIP telephones) in a **LAN** to be concealed behind a shared IP address for the **Router** on the **Internet**.

VoIP telephones behind a NAT router cannot be reached by VoIP servers (on account of the private IP address). In order to "get around" NAT, it is possible

## Glossary

to use (alternatively) **ALG** in the router, **STUN** in the VoIP telephone, or for the VoIP provider to use an **Outbound proxy**.

If an outbound proxy is made available you must allow for this in the VoIP settings for your phone.

### Network

Group of devices. Devices can be connected in either wired or wireless mode.

Networks can also differ in range and structure:

- Range: local networks (**LAN**) or wide-area networks (**WAN**)
- Structure: **Infrastructure network** or ad-hoc network

### Network subscribers

Devices and computers that are connected to each other in a network, e.g. servers, PCs and phones.

## O

### Outbound proxy

Alternative NAT control mechanism to STUN and ALG.

Outbound proxies are implemented by the VoIP provider in firewall/NAT environments as an alternative to **SIP proxy server**. They control data traffic through the firewall.

Outbound proxy and STUN servers should not be used simultaneously.

See also: **STUN** and **NAT**.

## P

### Paging (handset search)

A base station function to locate registered handsets. The base station establishes a connection to every registered handset. The handsets start to ring. Paging is activated by briefly pressing the button on the base station and is deactivated by briefly pressing the same button again.

## PIN

Personal Identification Number

Protects against unauthorised use.

When the PIN is activated a number combination has to be entered in order to access a protected area.

You can protect your base station configuration data with a system PIN (4-digit number combination).

## Port

Data is exchanged between two applications in a **Network** via a port.

### Port forwarding

The Internet gateway (e.g. your router) forwards data packets from the **Internet** that are directed to a certain **Port** to the port concerned. This allows servers in the **LAN** to offer services on the Internet without you needing a public IP address.

### Port number

Indicates a specific application of **Network subscribers**. Depending on the setting in the **LAN**, the port number is permanently assigned or else it is newly assigned with each access.

The combination of **IP address/Port** number uniquely identifies the recipient or sender of a data packet within a network.

### Pre-dialling

See **Block dialling**.

### Private IP address

See **Public IP address**.

## Protocol

Describes the agreements for communicating within a **Network**. It contains rules for opening, administering and closing a connection, about data formats, time frames and possible error handling.

**Proxy/Proxy server**

Computer program that controls the exchange of data between **Client** and **Server** in computer networks. If the phone sends a query to the VoIP server, the proxy acts as a server towards the phone and as a client towards the server. A proxy is addressed via **IP address/Domain names** and **Port**.

**Public IP address**

The public IP address is the address for a network component on the Internet. It is assigned by the Internet Service Provider. Devices that act as a link from a local network to the Internet (gateway, router) have a public and a local IP address.

See also: **IP address, NAT**

**Q****Quality of Service (QoS)**

Describes the Quality of Service in communication networks. Differentiations are made between various Quality of Service classes.

QoS influences the flow of data packets on the Internet, e.g. by prioritising data packets, reserving bandwidth and data packet optimisation.

In VoIP networks, QoS influences the voice quality. If the whole infrastructure (router, network server etc.) has QoS, the voice quality is better, i.e. fewer delays, less echoing, less crackling.

**R****RAM**

Random Access Memory

Memory in which you have reading and storage rights. Items such as melodies and screen pictures are saved in the RAM after you have loaded them onto the phone via the Web configurator.

**Registrar**

The registrar manages the **Network subscribers'** current IP addresses. When you register with your VoIP provider, your current IP address is saved on the registrar. This means you can also be reached when on the move.

**Ringback when the call is not answered**

= CCNR (Completion of Calls on No Reply). If a called party does not respond when called, a caller can arrange an automatic ringback. As soon as the destination phone has completed a call and is free again the caller is rung back. This feature must be supported by the exchange. The ringback request is automatically cancelled after about 2 hours (depending on the VoIP provider).

**Ringback when the number is busy**

= CCBS (Completion of Calls to Busy Subscriber). If a caller hears the busy tone, he or she can activate the ringback function. As soon as the connection is free the caller is rung back. As soon as the caller lifts his receiver the connection is made automatically.

**ROM**

Read Only Memory

A type of memory that can only be read, as opposed to RAM which can be both read and written.

**Router**

Routes data packets within a network and between different networks via the quickest route. Can connect **Ethernet networks** and **WLAN**. Can be a **Gateway** to the Internet.



## Glossary

### Routing

Routing is the transfer of data packets to another subscriber in your network. On their way to the recipient, the data packets are sent from one router to the next until they reach their destination.

If data packets were not forwarded in this way, a network like the Internet would not be possible. Routing connects the individual networks to this global system.

A router is a part of this system; it transfers data packets both within a local network and from one network to the next. Transfer of data from one network to another is performed on the basis of a common protocol.

### RTP

Realtime Transport Protocol

Global standard for transferring audio and video data. Often used in conjunction with UDP. In this case, RTP packets are embedded in UDP packets.

### RTP port

(Local) **Port** that is used to send and receive voice data packets for VoIP.

## S

### Server

Provides a service to other **Network subscribers (Clients)**. The term can indicate a computer/PC or an application. A server is addressed via **IP address/Domain namen** and **Port**.

### SIP (Session Initiation Protocol)

Signalling protocol independent of voice communication. Used for establishing and ending a call. It is also possible to define parameters for voice transmission.

### SIP address

See **URI**.

### SIP port/Local SIP port

(Local) **Port** which is used to send and receive SIP signalling data for VoIP.

### SIP provider

See **VoIP provider**.

### SIP proxy server

IP address of your VoIP provider's gateway server.

### Static IP address

A static IP address is assigned to a network component manually during network configuration. Unlike the **Dynamic IP address** a static (fixed) IP address never changes.

### STUN

Simple Transversal of UDP over NAT  
NAT control mechanism.

STUN is a data protocol for VoIP telephones. STUN replaces the private IP address in the data packets of the VoIP telephone with the public address of the secure private network. To control data transfer, a STUN server is also required on the Internet. STUN cannot be implemented with symmetric NATs. See also: **ALG, Firewall, NAT, Outbound proxy**.

### Subnet

Segment of a **Network**.

### Subnet mask

**IP addresses** consist of a fixed line number and a variable subscriber number. The network number is identical for all **Network subscribers**. The proportion of the IP address made up of the network number is determined in the subnet mask. In the subnet mask 255.255.255.0, for e.g., the first three parts of the IP address are the network number and the last part the subscriber number.

### Symmetric NAT

A symmetric NAT assigns different external IP addresses and port numbers to the same internal IP addresses and port numbers – depending on the external target address.

**T****TCP**

Transmission Control Protocol

**Transport protocol.** Session-based transmission protocol: it sets up, monitors and terminates a connection between sender and recipient for transporting data.

**TLS**

Transport Layer Security

Protocol for encrypting data transmissions on the Internet. TLS is a superordinated **Transport protocol**.

**Toggleing**

Toggleing allows you to switch between two callers or between a conference call and an individual caller without allowing the waiting caller to screen the call.

**Transmission rate**

Speed at which data is transmitted in the **WAN** or **LAN**. The transfer rate is measured in data units per unit of time (Mbit/s).

**Transport protocol**

Controls data transport between communication partners (applications).

See also: **UDP**, **TCP**, **TLS**.

**U****UDP**

User Datagram Protocol

**Transport protocol.** Unlike **TCP**, **UDP** is a non session-based protocol. It does not establish a fixed connection. The data packets (datagrams) are sent as broadcast. The recipient is solely responsible for making sure the data is received. The sender is not notified about whether it is received.

**URI**

Uniform Resource Identifier

Character sequence for identifying resources (e.g. e-mail recipient, <http://siemens.com>, files).

On the **Internet** URIs are used as a uniform identification for resources. URIs are also described as SIP addresses.

URIs can be entered in the phone as a number. By dialling a URI you can call an Internet subscriber with VoIP equipment.

**URL**

Universal Resource Locator

Globally unique address of a domain on the **Internet**.

A URL is a subtype of **URI**. URLs identify a resource by its location on the **Internet**. For historical reasons the term is often used as a synonym for URI.

**User identification**

User ID

Name/number combination for access, e.g. to your VoIP account.

**V****Voice codec**

See **Codec**.

**VoIP**

Voice over Internet Protocol

Telephone calls are no longer placed and transmitted over the telephone network but over the **Internet** (or other IP networks).

**VoIP provider**

A VoIP, SIP or **Gateway provider** is an Internet service provider that provides a **Gateway** for Internet telephony. As the phone works with the SIP standard, your provider must support the SIP standard.

The provider routes calls from VoIP to the telephone network (analogue, ISDN and mobile radio) and vice versa.

**W****WAN**

Wide Area Network

Wide-area network that is unrestricted in terms of area (e.g. **Internet**).

# Index

---

## A

- Access protection . . . . . 96
- Access to Web configurator
  - from other networks . . . . . 110
- Accessories . . . . . 157
- Account name (e-mail) . . . . . 128
- Activate annex B for G.729 . . . . . 119
- Activating
  - advisory tones . . . . . 90
  - answer machine . . . . . 61
  - answer machine from
    - external location . . . . . 67
  - appointment . . . . . 92
  - auto answer . . . . . 88
  - handset . . . . . 1, 31
  - handsfree talking . . . . . 31
  - keypad lock . . . . . 31
  - network mailbox . . . . . 78, 126
  - repeater mode . . . . . 98
  - room monitor . . . . . 85
  - two-way recording . . . . . 65
  - withholding phone numbers . . . . . 37
- Address assignment (IP address) . . . . . 109
- ADSL . . . . . 160
- Advisory tones . . . . . 90
- Alarm clock . . . . . 91
- Alert tone
  - activating/deactivating . . . . . 90
- ALG . . . . . 160
- Alternative DNS server
  - (Web configurator) . . . . . 109
- Anniversary
  - deactivating . . . . . 45
  - displaying missed ones . . . . . 93
  - missed . . . . . 45, 93
  - storing . . . . . 45
- Announce only mode (ans. mach.) . . . 61
- Announcement (answer machine) . . . 63
- Anonymous calling . . . . . 37
- Answer and record mode
  - (ans. mach.) . . . . . 61
- Answer machine . . . . . 61
  - activating/deactivating . . . . . 61
  - assigning receive numbers . . . . . 121
  - define for fast access . . . . . 79
  - deleting messages . . . . . 64
  - list . . . . . 50
  - playing back messages . . . . . 63
  - record announcement/notification . . 62
  - remote operation . . . . . 66
  - scrolling back . . . . . 64
  - scrolling forward . . . . . 64
- Application Layer Gateway (ALG) . . . 160
- Application signal (recall key) . . . . 122
- Application type (recall key) . . . . . 122
- Appointments . . . . . 92, 93
  - activating/deactivating . . . . . 92
  - deleting . . . . . 92
  - displaying missed ones . . . . . 93
  - managing . . . . . 92
- Area code
  - dialling automatically . . . . . 123
  - entering own area code . . . . . 123
  - setting own area code . . . . . 95, 123
- Area code predialling
  - activating/deactivating . . . . . 123
- Assigning a key . . . . . 87
- Asymmetric Digital Subscriber Line . . 160
- Attaching the belt clip . . . . . 19
- Audio (DTMF signalling) . . . . . 122
- Authentication . . . . . 160
- Authorisation . . . . . 143
- Auto answer . . . . . 28
  - activating/deactivating . . . . . 88
- Auto configuration code . . . . . 15, 112
- Automatic configuration
  - e. VoIP connection . . . . . 15, 112
- Automatic redial . . . . . 48
- Automatic version check . . . . . 133
- Available codecs . . . . . 118
- Away from computer (messenger) . . . 73

## B

- Base selection . . . . . 82
- Base station
  - activating/deactivating eco mode . . 20
  - changing system PIN . . . . . 96
  - checking service information . . . . 142
  - connecting . . . . . 13
  - connecting with fixed line network . . 14
  - connecting with mains power
    - supply . . . . . 14
  - connecting with router . . . . . 15
  - operating on PABX . . . . . 102
  - power consumption . . . . . 145
  - reducing power consumption . . . . . 20

- reducing transmission power . . . . . 20
- restoring to factory settings. . . . . 96
- selecting . . . . . 82
- setting . . . . . 96
- setting default connection . . . 98, 119
- setting up. . . . . 12
- updating firmware . . . . . 98, 132
- wall mounting . . . . . 184
- Battery
  - charging. . . . . 1, 11
  - display . . . . . 1, 11
  - icon . . . . . 1, 11
  - inserting . . . . . 10
  - recommended batteries . . . . . 145
  - tone . . . . . 90
- Best base station . . . . . 82
- Birthday, see Anniversary
- Block dialling . . . . . 160
- Bluetooth
  - accepting a call . . . . . 29
  - activating/deactivating . . . . . 94
  - changing device name . . . . . 95
  - de-registering device . . . . . 94
  - list of known devices. . . . . 94
  - registering device . . . . . 94
  - transferring directory (vCard) . . . . . 44
- Broadband connections . . . . . 9
- Broadband Internet access . . . . . 160
- Broadband speech codec . . . . . 117, 163
- Buddy . . . . . 71, 160
  - buddy messages. . . . . 75
  - calling . . . . . 77
  - checking information . . . . . 74
  - list . . . . . 71
  - opening list . . . . . 74
  - status changes . . . . . 74
- Busy (messenger) . . . . . 73
- Buttons (Web configurator) . . . . . 107
- C**
- Calendar . . . . . 92
- Call
  - accepting . . . . . 28
  - accepting (Bluetooth) . . . . . 29
  - disconnecting (toggling). . . . . 38, 40
  - ending . . . . . 28
  - external . . . . . 30
  - forwarding (VoIP) . . . . . 40
  - internal . . . . . 83
  - number/name display . . . . . 29
  - picking up from answer machine . . . 64
  - rejecting external . . . . . 84
  - transferring (connecting). . . . . 83
  - two-way recording. . . . . 65
- Call acceptance . . . . . 65
  - automatic . . . . . 88
- Call display . . . . . 29
  - fixed line network . . . . . 29
  - name from online directory . . . 30, 129
  - VoIP . . . . . 29
- Call duration display . . . . . 52
- Call forwarding . . . . . 160
  - configuring (VoIP) . . . . . 123
  - fixed line network . . . . . 37
  - Gigaset.net . . . . . 39, 121
  - VoIP . . . . . 40
  - VoIP (handset). . . . . 39
  - VoIP (Web configurator). . . . . 121
- Call placing, see Call forwarding
- Call screening during recording . . . . . 65
- Call waiting . . . . . 160
  - accepting/rejecting (fixed line network). . . . . 38
  - accepting/rejecting (VoIP). . . . . 40
  - activating/deactivating . . . . . 38
  - activating/deactivating (fixed line network). . . . . 38
  - activating/deactivating (VoIP) . . . . . 39
  - internal call . . . . . 84
- Call-by-call list. . . . . 41
  - key . . . . . 1
- Call-by-call numbers . . . . . 41, 51
- Calling
  - anonymously. . . . . 37
  - entering IP address . . . . . 27
  - external. . . . . 26
  - from classified directory . . . . . 47
  - from online directory . . . . . 47
  - Gigaset.net . . . . . 35, 36
  - internal . . . . . 83
  - via VoIP/fixed line network . . . . . 26
- Calling Line Identification . . . . . 29
- Calling Line Identification Presentation. . . . . 29
- Calls list . . . . . 49
- Cancelling
  - dialling . . . . . 27
  - operation . . . . . 32, 33, 107
  - ring back (fixed line network). . . . . 39

## Index

Care of the telephone . . . . . 136  
CF, see Call forwarding  
Changing  
    dialling mode . . . . . 102  
    earpiece volume . . . . . 88  
    handsfree volume . . . . . 88  
    internal number . . . . . 82, 130  
    system PIN . . . . . 96  
    to summertime . . . . . 134  
Character set table,  
    see Special characters  
Charge saving function  
    (remote operation) . . . . . 65  
Charge status display (battery) . . . 1, 11  
Charging cradle  
    connecting . . . . . 183  
    wall mounting . . . . . 183  
Chatting . . . . . 71, 160  
    with buddies . . . . . 75  
Checking EEPROM version . . . . . 135  
Classified directory . . . . . 45  
CLI . . . . . 29  
Client . . . . . 160  
CLIP . . . . . 29  
CLIP picture . . . . . 29, 42, 90  
Codecs . . . . . 160  
    available codecs . . . . . 118  
Colour scheme (display) . . . . . 86  
COLP . . . . . 30, 161  
COLR . . . . . 30, 161  
Conference . . . . . 84  
Conference call  
    VoIP . . . . . 40  
Configuration  
    of phone via PC . . . . . 104  
    VoIP connection (automatic) . . . 112  
Configuring  
    network mailbox . . . . . 78  
    VoIP connection (handset) . . . . 100  
    VoIP connection (Web config.) . . 110  
Confirmation tone . . . . . 90  
Connected Line Identification  
    Presentation/Restriction . . . . 30, 161  
Connecting  
    charging cradle . . . . . 11  
    PC with Web configurator . . . . . 104  
    to the Web configurator . . . . . 104

Connection  
    activating (VoIP) . . . . . 116  
    Internet (troubleshooting) . . . . 18  
    name/provider (Web config.) . . . 111  
    to Gigaset.net . . . . . 116  
    to messenger server . . . . . 72  
Connection assistant  
    starting (getting started) . . . . . 16  
Connection name  
    fixed line network . . . . . 116  
    VoIP . . . . . 112  
Connection socket for headset . . . 1, 19  
Connection type  
    selecting (display key) . . . . . 26  
    selecting (talk key) . . . . . 26  
Consultation call . . . . . 161  
    ending . . . . . 84  
    external (fixed line network) . . . 38  
    external (VoIP) . . . . . 40  
    internal . . . . . 32, 84  
Contrast (display) . . . . . 86  
Control key . . . . . 1  
    functions . . . . . 32  
Correcting incorrect entries . . . . . 33  
Cost control . . . . . 8, 51  
    defining dialling plans . . . . . 124  
Customer Care . . . . . 143

## D

Data packets, fragmentation . . . . . 163  
Data server for firmware update . . . 132  
Date  
    set manually . . . . . 11  
    transferring from time server . . . 134  
Deactivating  
    advisory tones . . . . . 90  
    answer machine . . . . . 61  
    appointment . . . . . 92  
    appointment reminder . . . . . 93  
    auto answer . . . . . 88  
    handset . . . . . 1, 31  
    handsfree talking . . . . . 31  
    keypad lock . . . . . 31  
    network mailbox . . . . . 78, 126  
    repeater mode . . . . . 98  
    room monitor . . . . . 85  
    two-way recording . . . . . 65  
    withholding phone numbers . . . . 37

- Default settings
  - handset . . . . . 96
- Delete key . . . . . 32
- Deleting
  - announcement for answer
    - machine . . . . . 63
  - characters . . . . . 33
  - e-mail . . . . . 70
  - message (answer machine) . . . . . 64
- Demilitarised Zone . . . . . 161
- De-registering
  - from Web configurator . . . . . 105
  - handset from base station . . . . . 82
- Destination number
  - room monitor . . . . . 85
- Device (Bluetooth)
  - changing name . . . . . 95
  - de-registering . . . . . 94
  - registering . . . . . 94
- DHCP . . . . . 161, 162
- Dialling
  - cancelling . . . . . 27
  - IP address . . . . . 27
  - with directory . . . . . 42
  - with quick dial . . . . . 43, 87
- Dialling plans . . . . . 8, 51, 124
  - activating/deactivating . . . . . 125
  - defining . . . . . 124
  - deleting . . . . . 125
  - for emergency numbers . . . . . 125
- Differentiated Service Code Point . . . 162
- Digit key
  - assigning a number/function . . . . . 87
- Digital Subscriber Line . . . . . 162
- Digital Subscriber Line
  - Access Multiplexer . . . . . 162
- Directory . . . . . 41
  - copying number . . . . . 44
  - deleting (Web configurator) . . . . . 131
  - editing via PC . . . . . 130
  - Gigaset.net . . . . . 34
  - in a file on the PC (vCard format) . . 132
  - loading from PC . . . . . 131
  - opening . . . . . 32, 45
  - order of entries . . . . . 149
  - saving anniversary . . . . . 45
  - saving entry . . . . . 41
  - saving numbers from SMS text . . . . . 56
  - searching for an entry . . . . . 46
  - selecting entry . . . . . 42
  - sending entry/list to handset . . . . . 43
  - storing SMS sender's number . . . . . 56
  - transferring a vCard (Bluetooth) . . . 44
  - transferring to/from PC . . . . . 130
  - using to enter numbers . . . . . 44
- Display
  - backlight . . . . . 87
  - call duration . . . . . 52
  - caller's number (CLI/CLIP) . . . . . 29
  - changing display language . . . . . 86
  - colour scheme/contrast . . . . . 86
  - in idle status . . . . . 1
  - memory (directory) . . . . . 43
  - memory (My stuff) . . . . . 91
  - missed appointment/anniversary . . 93
  - name from online directory . . 30, 129
  - screensaver . . . . . 86
  - setting . . . . . 86
  - wrong language . . . . . 86
- Display keys . . . . . 1, 32
  - assigning a number/function . . . . . 87
  - change configuration . . . . . 88
- Displayed name (VoIP) . . . . . 113, 161
- Disposal
  - electrical and electronic devices . . . 7
- DMZ . . . . . 161
- DNS . . . . . 162
- DNS server
  - alternative (Web configurator) . . . 109
  - preferred (handset) . . . . . 101
  - preferred (Web configurator) . . . . . 109
- Do not disturb (messenger) . . . . . 73
- Domain . . . . . 114
- Domain name . . . . . 162
- Domain Name System . . . . . 162
- Draft message list (SMS) . . . . . 54
- DSCP . . . . . 162
- DSL . . . . . 162
- DSLAM . . . . . 162
- DTMF (tone dialling) . . . . . 103
- DTMF-reminder for VoIP . . . . . 122
- Dynamic DNS . . . . . 162
- Dynamic Host Configuration
  - Protocol . . . . . 161
- Dynamic IP address . . . . . 109, 162
- DynDNS . . . . . 162

- E**
- Earpiece mode . . . . . 31
  - Earpiece volume . . . . . 88
  - EATONI (predictive text) . . . . . 148
  - Echo service
    - Gigaset.net. . . . . 34
  - ECO DECT . . . . . 20
  - Eco mode . . . . . 20
  - E-mail
    - account name . . . . . 128
    - entering access data . . . . . 128
    - incoming e-mail server . . . . . 128
    - list . . . . . 68
    - messages whilst making a
      - connection. . . . . 69
    - notification. . . . . 68
    - registration name/password . . . . . 128
    - settings (Web config.) . . . . . 128
    - viewing the message header. . . . . 69
    - viewing the sender's address. . . . . 70
  - Emergency numbers
    - dialling. . . . . 28
    - dialling plans for. . . . . 125
    - when keypad lock is active . . . . . 7
  - End call key . . . . . 1, 27, 28
  - Ending, call . . . . . 28
  - Entering
    - access data (e-mail) . . . . . 128
    - flash . . . . . 1
    - pause. . . . . 1
  - Entering user data (VoIP)
    - with handset . . . . . 17
    - with Web configurator . . . . . 113
  - Error handling
    - messenger . . . . . 77
  - Error tone . . . . . 90
  - Ethernet network. . . . . 162
  - Example
    - menu input . . . . . 146
    - multiple line input . . . . . 147
  - Explicit Call Transfer . . . . . 162
  - External call
    - forwarding to ans. mach. . . . . 65
  - External consultation call
    - fixed line network. . . . . 38
    - VoIP. . . . . 40
- F**
- Factory settings
    - base station. . . . . 96
  - Fast access . . . . . 79
    - answer machine . . . . . 66
    - directory entries . . . . . 43
  - Firewall . . . . . 163
  - Firmware . . . . . 163
    - automatic update . . . . . 99
    - checking version . . . . . 135, 142
    - starting update (handset). . . . . 98
    - starting update (Web config.) . . . . . 132
    - update from local PC . . . . . 133
    - update, automatic . . . . . 133
    - version on delivery . . . . . 10
  - Firmware update. . . . . 10
    - automatic . . . . . 133
  - Fixed line network
    - accepting/rejecting call waiting . . . . . 38
    - activating/deactivating call waiting . . . . . 38
    - anonymous calling. . . . . 37
    - call forwarding . . . . . 37
    - cancelling ring back . . . . . 39
    - connection name. . . . . 116
    - enter network mailbox. . . . . 78
    - external consultation call . . . . . 38
    - settings for calls. . . . . 38
    - toggling . . . . . 38
    - withholding phone numbers . . . . . 37
  - Fixed line network connection
    - creating settings . . . . . 37
    - line suffix . . . . . 111
  - Flat rate . . . . . 163
  - Fragmentation of data packets. . . . . 163
  - Free software, licences . . . . . 150
  - Full duplex . . . . . 163
- G**
- G.711  $\mu$  law . . . . . 117
  - G.711 a law . . . . . 117
  - G.722. . . . . 9, 117
  - G.722 Broadband language codec . . . . . 117
  - G.726. . . . . 117
  - G.729. . . . . 117
  - Gateway . . . . . 164
  - Gateway provider . . . . . 164
  - Gigaset config. . . . . 104, 105

- Gigaset HDSP, see HDSP
  - Gigaset.net . . . . . 34
    - (de)activating the connection . . . 116
    - call forwarding . . . . . 39, 121
    - calling subscriber . . . . . 35, 36
    - changing/deleting own name . . . . 36
    - directory . . . . . 34
    - Echo service . . . . . 34
    - entering name . . . . . 17, 36
    - Jabber server . . . . . 127
    - messaging . . . . . 127
    - searching for subscriber . . . . . 34
  - Global IP address . . . . . 164
  - Global System for
    - Mobile Communication . . . . . 164
  - GNU Lesser General Public License . . 150
  - Going online (messenger) . . . . . 72
  - Group call . . . . . 83
  - GSM . . . . . 164
  - Guarantee Certificate . . . . . 144
- ## H
- Handset
    - activating/deactivating . . . . . 1, 31
    - activating/deactivating advisory
      - tones . . . . . 90
    - assigning a receive number . . . . . 120
    - assigning a send number . . . . . 120
    - base station selection . . . . . 82
    - changing internal names. . . . . 83, 130
    - changing internal number. . . . . 82, 130
    - changing name . . . . . 83, 130
    - changing to a different base
      - station . . . . . 82
    - changing to best reception . . . . . 82
    - checking service information. . . . . 142
    - contact with liquid . . . . . 136
    - de-registering . . . . . 82
    - display backlight. . . . . 87
    - display language. . . . . 86
    - earpiece volume. . . . . 88
    - handsfree volume. . . . . 88
    - idle status . . . . . 33
    - list . . . . . 32, 130
    - locating . . . . . 82
    - loudspeaker volume . . . . . 32
    - muting. . . . . 31
    - operating . . . . . 31
    - reducing transmission power . . . . . 20
    - registering. . . . . 12, 81
    - resetting . . . . . 96
    - restoring to factory settings . . . . . 96
    - screensaver . . . . . 86
    - setting (individual). . . . . 86
    - setting up . . . . . 10
    - transferring a call. . . . . 83
    - using room monitor. . . . . 84
    - using several . . . . . 81
  - Handset directory, see Directory
  - Handset operating time
    - in room monitor mode. . . . . 85
  - Handsfree
    - activating/deactivating. . . . . 31
    - key . . . . . 1
    - mode . . . . . 31
    - talking. . . . . 31
  - Hash key. . . . . 1, 31
  - HDSP . . . . . 8, 9, 117
  - Headset . . . . . 1, 19, 164
  - Hearing aids . . . . . 6
  - High Definition Sound Performance,
    - see HDSP
  - HTTP proxy . . . . . 164
  - Hub . . . . . 164
- ## I
- Icon
    - alarm clock . . . . . 92
    - answer machine . . . . . 61
    - battery . . . . . 11
    - new message . . . . . 63
    - new messenger message . . . . . 75
    - new SMS . . . . . 55
    - ringer tone deactivated . . . . . 89
  - Idle status
    - back to . . . . . 33
    - display . . . . . 1
  - IEEE . . . . . 164
  - Incoming e-mail server (e-mail) . . . . 128
  - Incoming message list
    - opening (SMS). . . . . 55
  - Incoming message list (e-mail)
    - opening . . . . . 68
  - Incorrect input (correction) . . . . . 33
  - Info messages (messenger) . . . . . 75
  - Info services . . . . . 128
    - configuring (Internet) . . . . . 129
  - Infrastructure network . . . . . 164



## Index

Input language (message) . . . . . 149  
Installing, base station . . . . . 12  
Instant messaging . . . . . 71, 126, 164  
    preconditions . . . . . 71  
Institute of Electrical and  
    Electronics Engineers . . . . . 164  
Interface language  
    handset . . . . . 86  
    Web configurator . . . . . 105  
Internal call . . . . . 83  
    call waiting . . . . . 84  
Internal consultation call . . . . . 32, 84  
Internet . . . . . 164  
    access (broadband) . . . . . 160  
    no connection to . . . . . 18  
    protocol . . . . . 164  
    service provider . . . . . 164  
IP . . . . . 164  
IP address . . . . . 165  
    assigning (handset) . . . . . 101  
    assigning (Web configurator) . . . . . 109  
    automatically obtaining one . 101, 109  
    checking (handset) . . . . . 101  
    checking (Web configurator) . . . . . 135  
    dialling . . . . . 27  
    displaying on handset . . . . . 2  
    dynamic . . . . . 162  
    global . . . . . 164  
    local . . . . . 165  
    private . . . . . 166  
    public . . . . . 167  
    static . . . . . 168  
IP address type . . . . . 101, 109  
IP configuration  
    handset . . . . . 101  
    Web configurator . . . . . 109  
IP pool range . . . . . 165

**J**

Jabber ID (messenger) . . . . . 127  
Jabber server (messenger) . . . . . 127  
Jabber server port (messenger) . . . . . 127

**K**

Key 1 (fast access) . . . . . 1, 66  
    assigning . . . . . 79  
Key click . . . . . 90  
Keypad  
    change configuration . . . . . 88  
Keypad lock . . . . . 7, 31

Keys  
    assigning directory entry . . . . . 43  
    call-by-call list . . . . . 1  
    cancel key . . . . . 32  
    control key . . . . . 1, 32  
    delete key . . . . . 32  
    display keys . . . . . 1, 32  
    end call key . . . . . 1, 27, 28, 33  
    fast access . . . . . 1, 66  
    handsfree key . . . . . 1  
    hash key . . . . . 1, 31  
    keypad lock . . . . . 31  
    message key . . . . . 1, 48  
    on/off key . . . . . 1  
    paging key (base station) . . . . . 2  
    quick dial . . . . . 43  
    recall key . . . . . 1  
    star key . . . . . 1, 89  
    talk key . . . . . 1

## L

LAN . . . . . 165  
Language  
    handset/display . . . . . 86  
    Web configurator . . . . . 105  
Last number redial . . . . . 48  
LGPL . . . . . 150  
Licences, free software . . . . . 150  
Line suffix  
    dialling with . . . . . 27  
    display (Web configurator) . . . . . 111  
Line type for outgoing calls,  
    see Standard connection  
Linking, see SMS  
Liquid . . . . . 136  
List  
    answer machine list . . . . . 50  
    calls list . . . . . 49  
    e-mail notifications . . . . . 68  
    handsets . . . . . 32, 130  
    known devices (Bluetooth) . . . . . 94  
    last number redial list . . . . . 48  
    missed calls . . . . . 49  
    network mailbox . . . . . 80  
Local Area Network . . . . . 165  
Local communication ports . . . . . 122  
Local IP address . . . . . 165  
Local network . . . . . 109  
Local SIP port . . . . . 168

- Lock (keypad lock) . . . . . 31
- Login password
  - messenger . . . . . 127
- Lost connection
  - messenger . . . . . 72, 77
- Loudspeaker volume . . . . . 32
- M**
- MAC address . . . . . 165
  - checking (handset) . . . . . 102
  - checking (Web configurator) . . . . . 135
- Mailbox ID, see SMS
- Mailboxes, see SMS
- Main menu . . . . . 21, 33
- Mains adapter . . . . . 6
- Making calls
  - accepting a call . . . . . 28
  - cost-effective calls . . . . . 51
  - external (VoIP, fixed line network) . . . . . 26
  - internal . . . . . 83
- Maximum Receive Unit. . . . . 165
- Maximum Transmission Unit. . . . . 165
- Mbps. . . . . 165
- Media Access Control . . . . . 165
- Medical appliances. . . . . 6
- Memory
  - directory . . . . . 43
  - My stuff . . . . . 91
- Menu
  - end tone . . . . . 90
  - going back one menu level . . . . . 32, 33
  - menu guidance . . . . . 33
  - menu input . . . . . 146
  - opening . . . . . 32
  - phone overview . . . . . 21
  - Web configurator overview . . . . . 25
- Menu bar (Web configurator) . . . . . 106
- Message
  - answer machine list . . . . . 50
  - deleting (answer machine) . . . . . 64
  - deleting (e-mail) . . . . . 70
  - deleting (messenger) . . . . . 76
  - marking as "new" (ans. mach.) . . . . . 64
  - new message icon . . . . . 63
  - playback via remote operation
    - (ans. mach.) . . . . . 67
  - playing (network mailbox) . . . . . 80
  - playing back . . . . . 63
  - playing back (answer machine) . . . . . 50
  - reading the subject (e-mail) . . . . . 69
  - receiving (messenger) . . . . . 75
  - receiving (SMS) . . . . . 55
  - writing/sending (messenger) . . . . . 76
  - writing/sending (SMS) . . . . . 54
- Message key . . . . . 1
  - opening lists . . . . . 48
- Message list
  - answer machine . . . . . 50, 63
  - e-mail . . . . . 68
  - messenger. . . . . 75
  - network mailbox . . . . . 80
  - SMS . . . . . 55
- Messaging via Gigaset.net . . . . . 127
- Messenger . . . . . 71
  - account. . . . . 127
  - calling buddy. . . . . 77
  - change own status. . . . . 73
  - entering access data . . . . . 126
  - error handling . . . . . 77
  - errors when sending . . . . . 77
  - lost connection . . . . . 72, 77
  - message list. . . . . 75
  - priority . . . . . 127
  - resource name. . . . . 127
- Messenger message
  - deleting. . . . . 76
  - reading . . . . . 76
  - receiving . . . . . 75
  - writing/sending . . . . . 76
- Messenger server . . . . . 71
  - establishing a connection. . . . . 72
- Microphone . . . . . 1
  - muting . . . . . 31
- Million bits per second . . . . . 165
- Missed
  - anniversary . . . . . 93
  - appointment . . . . . 93
  - calls . . . . . 49
- MRU. . . . . 165
- MTU. . . . . 165
- Multiple line input. . . . . 147
- Music . . . . . 165
- Music on hold . . . . . 31, 97, 165
- Muting
  - handset. . . . . 31
- My stuff . . . . . 90

**N**

Name  
 changing name of the  
     handset . . . . . 83, 130  
     displaying (VoIP). . . . . 161  
     fixed line network  
         connection. . . . . 112, 116  
 of caller from online directory . 30, 129  
 NAT . . . . . 165  
     symmetric . . . . . 168  
     updating . . . . . 115  
 Navigation area (Web config.) . . . . 107  
 Network . . . . . 166  
     Ethernet. . . . . 162  
 Network Address Translation . . . . . 165  
 Network area . . . . . 114  
 Network mailbox . . . . . 78  
     activating/deactivating . . . . . 78, 126  
     calling . . . . . 79, 80  
     define for fast access . . . . . 79  
     entering number . . . . . 78, 126  
     list . . . . . 80  
 Network MB, see Network mailbox  
 Network provider (numbers list) . . . . 41  
 Network services  
     fixed line network. . . . . 37  
     fixed line network and VoIP. . . . . 37  
     settings for fixed line network  
         calls. . . . . 37, 38  
     settings for VoIP calls . . . . . 39, 40  
     VoIP. . . . . 39  
 Notification  
     incoming e-mail . . . . . 68  
     via SMS . . . . . 57  
 Number  
     as destination for room monitor . . . 85  
     copying from an SMS text . . . . . 56  
     copying from directory . . . . . 44  
     copying to directory . . . . . 44  
     displaying caller's number (CLIP) . . 29  
     entering network mailbox  
         number . . . . . 78, 126  
     entering with directory . . . . . 44  
     saving in the directory. . . . . 41  
 Number assignment. . . . . 120, 121  
 Numbers list, network provider. . . . . 41

**O**

Offline (messenger) . . . . . 71, 73  
 On/Off key . . . . . 1  
 Online (messenger). . . . . 71, 73  
 Online directory . . . . . 45  
     Gigaset.net . . . . . 34  
     register for access . . . . . 129  
 Opening  
     incoming mail list . . . . . 68  
 Operating times of the handset . . . . 145  
 Operation (preparing to use the  
     phone). . . . . 10  
 Order in directory . . . . . 149  
 Outbound proxy . . . . . 115, 166  
     mode . . . . . 115  
     port . . . . . 115  
 Own area code  
     setting . . . . . 95, 123

**P**

PABX  
     operating base station on PABX . . 102  
     pauses . . . . . 103  
     setting dialling mode . . . . . 102  
     setting recall . . . . . 102  
     SMS . . . . . 59  
 Pack contents . . . . . 10  
 Paging . . . . . 2, 82, 166  
 Pauses (PABX). . . . . 103  
 PC interface . . . . . 149  
 Personal Identification Number . . . . 166  
 Personal provider data. . . . . 113  
 Phone  
     configuring via PC . . . . . 104  
     functions, overview . . . . . 21  
     menu overview . . . . . 21  
     protecting (PIN). . . . . 96  
     setting (Web configurator) . . . . . 108  
     setting base station (on handset) . . 96  
     setting up . . . . . 10  
 Phone connection  
     configuring (handset) . . . . . 99  
 Phone jack pin configuration . . . . . 14  
 Phone status (Web configurator) . . . 135  
 Picture  
     deleting. . . . . 91  
     renaming . . . . . 91

- Picture-CLIP, see CLIP picture
  - PIN ..... 166
    - changing ..... 96
  - Playback (ans. mach.) ..... 50
    - remote operation ..... 67
  - Playing back
    - announcement (answer machine) . . . 63
    - message (answer machine) . . . . . 63
  - POP3 server ..... 128
  - Port. .... 166
  - Port forwarding ..... 166
  - Port number ..... 166
  - Power consumption
    - power consumption of
      - base station ..... 145
      - reducing for the base station. .... 20
  - Pre-dialling ..... 166
  - Predictive text ..... 148
  - Preferred DNS server
    - entering (handset) ..... 101
    - entering (Web configurator) ..... 109
  - Priority (messenger) ..... 127
  - Private IP address ..... 166
  - Problems and solutions ..... 136
  - Protocol. .... 166
  - Proxy ..... 167
  - Proxy server ..... 167
  - Proxy server address. .... 114
  - Public IP address ..... 167
- Q**
- Quality of Service. .... 167
  - Questions and answers ..... 136
  - Quick dial ..... 41, 43, 87
- R**
- RAM ..... 167
  - Random Access Memory ..... 167
  - Read Only Memory ..... 167
  - Reading message (messenger) ..... 76
  - Reading the subject (e-mail) ..... 69
  - Ready to chat (messenger) ..... 73
  - Recall ..... 84
  - Recall key ..... 1
    - function for VoIP. .... 122
  - Receive number
    - answer machine ..... 61
    - assigning to answer machine .... 121
    - assigning to handset. .... 120
    - display on the handset. .... 29
  - Recording
    - announcement/notification (answer machine) ..... 62
    - quality (answer machine) ..... 66
    - time (answer machine) ..... 66
    - two-way recording. .... 65
  - Registering
    - handset. .... 12, 81
    - with the Web configurator ..... 105
  - Registrar ..... 167
    - server ..... 114
    - server port ..... 114
  - Registration name
    - e-mail ..... 128
    - VoIP account ..... 17, 101, 113
  - Registration password
    - e-mail ..... 128
    - VoIP account ..... 17, 101, 113
  - Registration refresh time ..... 114
  - Reminder call (anniversary) ..... 45
  - Remote access to Web configurator . . 110
  - Remote management ..... 110
  - Remote operation ..... 66
  - Resetting
    - base station. .... 96
    - handset. .... 96
  - Resource name (messenger) ..... 127
  - RFC 2833 (DTMF signalling). .... 122
  - Ringback
    - initiating (fixed line network) . . . . 38
    - when busy ..... 167
    - when the call is not answered . . . 167
  - Ringer tone
    - activating/deactivating. .... 89
    - changing. .... 89
    - deactivating permanently. .... 89
    - muting ..... 28
    - setting melody. .... 89
    - setting volume ..... 89
  - ROM ..... 167
  - Room monitor. .... 84
  - Router ..... 167
    - connecting base station. .... 15
  - Routing ..... 168
  - RSS feeds (info service) ..... 128
  - RTP ..... 168
  - RTP port ..... 122, 168

**S**

Safety precautions . . . . . 6

Scope of delivery . . . . . 10

Screensaver . . . . . 86

Search for subscriber on Gigaset.net . . . 34

Searching

- for service information . . . . . 142
- handset . . . . . 82
- in directory . . . . . 42

Selecting

- announcement mode (ans. mach.) . 62
- connection (line suffix) . . . . . 27
- entry (menu) . . . . . 146
- online directory . . . . . 129

Send number

- assigning to handset . . . . . 120
- selecting via line suffix . . . . . 27

Sender's address (e-mail) . . . . . 70

Sensitivity (room monitor) . . . . . 85

Server . . . . . 168

Server for firmware update . . . . . 132

Server port . . . . . 114

Service . . . . . 143

Setting

- base station . . . . . 96
- date/time on handset . . . . . 11
- default connection . . . . . 98, 119
- flash time (PABX) . . . . . 102
- handset . . . . . 86
- online directory . . . . . 129
- phone for VoIP telephony . . . . . 111
- ringer tone melody . . . . . 89
- screensaver . . . . . 86
- time zone . . . . . 134

Shortcut (digit combination) . . . . . 21

Signal strength . . . . . 1

Signal tone, see Advisory tones

Simple Transversal of UDP over NAT . 168

SIP . . . . . 168

SIP address . . . . . 168

SIP Info (DTMF signalling) . . . . . 122

SIP port . . . . . 122, 168

SIP provider . . . . . 168

SIP proxy server . . . . . 168

Slumber mode (alarm clock) . . . . . 92

SMS . . . . . 53

- activating/deactivating function . . 59
- changing mailbox . . . . . 58
- deleting . . . . . 55
- draft message list . . . . . 54
- forwarding . . . . . 56
- input language . . . . . 54, 149
- linked . . . . . 53
- mailbox ID . . . . . 57
- notification by SMS . . . . . 57
- notification number . . . . . 57
- notification type . . . . . 57
- PIN protection . . . . . 58
- reading . . . . . 55
- receiving . . . . . 55
- registration assistant . . . . . 53
- replying to and forwarding . . . . . 56
- rules . . . . . 53
- saving number . . . . . 56
- self help with error messages . . . . 60
- sending to a personal mailbox . . . . . 58
- setting up a mailbox . . . . . 57
- to a PABX . . . . . 59
- troubleshooting . . . . . 60
- writing/sending . . . . . 54

SMS centre

- changing number . . . . . 58
- setting . . . . . 58

Snooze (alarm clock) . . . . . 92

Sound, see Ringer tone

Special characters . . . . . 147

Specifications . . . . . 145

Standard gateway

- entering (handset) . . . . . 101
- entering (Web configurator) . . . . 109

Star key . . . . . 1, 89

Starting connection assistant

- (menu) . . . . . 99

State of presence (messenger) . . . 71, 73

- setting own . . . . . 73

Static IP address . . . . . 109, 168

Status

- buddy . . . . . 71
- changing own (messenger) . . . . . 73
- VoIP connection . . . . . 111

Status codes (VoIP)

- activating display (handset) . . . . 102
- activating display (Web config.) . . 132
- codes table . . . . . 140

Structure of IP address . . . . . 165

STUN . . . . . 168

STUN port . . . . . 115

STUN refresh time . . . . . 115

- STUN server . . . . . 115
  - Submenu . . . . . 33
  - Subnet . . . . . 168
  - Subnet mask . . . . . 168
    - defining (handset) . . . . . 101
    - defining (Web configurator) . . . . . 109
  - Suffix . . . . . 111
    - dialling with . . . . . 27
  - Summer time
    - changing automatically to . . . . . 134
  - Suppressing
    - speech pauses (VoIP) . . . . . 119
    - silence (VoIP) . . . . . 119
    - speech pauses (VoIP) . . . . . 119
  - Switching off
    - call forwarding (fixed line network) . 37
    - call forwarding (VoIP) . . . . . 39
  - Switching on
    - call forwarding (fixed line network) . 37
    - call forwarding (VoIP) . . . . . 39
  - Symmetric NAT . . . . . 168
  - Synchronisation with time server . . 134
  - System settings . . . . . 96
- T**
- Talk key . . . . . 1
  - TCP . . . . . 169
  - Telephone connection
    - configuring (Web config.) . . . . . 110
  - Text information in idle display
    - mode . . . . . 128
  - Text message, see SMS
  - Time
    - set manually . . . . . 11
    - transferring from time server . . . . . 134
  - Time server . . . . . 134
  - TLS . . . . . 169
  - Toggling . . . . . 169
    - disconnecting call . . . . . 38, 40
    - fixed line network . . . . . 38
    - VoIP . . . . . 40
  - Touch tone dialling . . . . . 103
  - Transferring PC address book
    - to directory . . . . . 130
  - Transmission Control Protocol . . . . . 169
  - Transmission power
    - reducing for the base station . . . . . 20
    - reducing for the handset . . . . . 20
  - Transmission rate . . . . . 169
  - Transport Layer Security . . . . . 169
  - Transport protocol . . . . . 169
  - Troubleshooting . . . . . 136
    - e-mail . . . . . 69
    - general (table) . . . . . 136
    - Internet connection . . . . . 18
    - SMS . . . . . 60
- U**
- UDP . . . . . 169
  - Uniform Resource Identifier . . . . . 169
  - Universal Resource Locator . . . . . 169
  - Unknown . . . . . 30
  - Unknown caller . . . . . 30
  - URI . . . . . 169
  - URL . . . . . 169
  - Use random ports . . . . . 122
  - User Datagram Protocol . . . . . 169
  - User identification . . . . . 169
  - User name
    - (VoIP-Account) . . . . . 17, 100, 113
- V**
- vCard format . . . . . 132
  - vcf file . . . . . 130
  - Version check, automatic . . . . . 133
  - VIP (directory entry) . . . . . 43
  - Voice over Internet Protocol . . . . . 9, 169
  - Voice quality . . . . . 117
  - Voice quality and infrastructure . . . 119
  - VoIP . . . . . 169
    - accepting/rejecting call waiting . . . 40
    - activate/deactivate network mailbox 78
    - activating/deactivating call waiting. 39
    - activating/deactivating status
      - message . . . . . 102
    - advantages . . . . . 9
    - anonymous calling . . . . . 37
    - assigning IP address . . . . . 101
    - call forwarding . . . . . 39, 40
    - completing settings . . . . . 18
    - conference call . . . . . 40
    - configuring account . . . . . 111
    - configuring account (first) . . . . . 17
    - connection name . . . . . 112
    - enter network mailbox . . . . . 78
    - external consultation call . . . . . 40
    - loading provider data . . . . . 16, 100, 112
    - making call settings . . . . . 39
    - network services . . . . . 39
    - phone number . . . . . 17, 112

## Index

- preconditions . . . . . 9
- setting call forwarding . . . . . 123
- settings (on handset) . . . . . 99
- show called party number . . . . . 30
- starting connection assistant . . . 15, 99
- status codes (table) . . . . . 140
- toggle . . . . . 40
- withholding phone numbers . . . . . 37
- VoIP connection
  - activating/deactivating . . . . . 111, 116
  - automatic configuration . . . . . 112
  - configuring (handset) . . . . . 99
  - configuring (Web configurator) . . . 111
  - line suffix . . . . . 111
  - name (Web configurator) . . . . . 112
  - name/provider (Web config.) . . . . . 111
- VoIP provider . . . . . 169
  - downloading data . . . . . 16, 100, 112
  - selecting (handset) . . . . . 16, 100
  - selecting (Web configurator) . . . . . 113
  - updating data automatically . . . . . 133
- VoIP status messages
  - activating display (handset) . . . . . 102
  - activating display (Web config.) . . . 132
  - status codes table . . . . . 140
- VoIP telephony
  - settings (Web config.) . . . . . 111
- VoIP user data
  - entering (connection assistant) . . . . . 17
  - entering (handset) . . . . . 100
  - entering (Web configurator) . . . . . 113
- Volume
  - earpiece volume . . . . . 32, 88
  - handsfree . . . . . 32, 88
  - loudspeaker . . . . . 88
  - ringer tone . . . . . 89
- W**
- Wall mounting
  - base station . . . . . 184
  - charging cradle . . . . . 183
- WAN . . . . . 169
- Warning tone, see Advisory tones
- Weather forecasts, in idle display
  - mode . . . . . 129
- Weather reports (info service) . . . . . 128
- Web configurator . . . . . 104
  - (de)activating VoIP connection . . . 111
  - alternative DNS server . . . . . 109
  - assign receive number . . . . . 121
  - assign receive number to
    - ans. mach. . . . . 121
  - assigning receive number . . . . . 120
  - assigning send number . . . . . 120
  - checking EEPROM version . . . . . 135
  - checking firmware version . . . . . 135
  - checking IP address . . . . . 135
  - checking MAC address . . . . . 135
  - connecting with PC . . . . . 104
  - creating e-mail settings . . . . . 128
  - defining IP address . . . . . 109
  - defining standard gateway . . . . . 109
  - de-registering . . . . . 105
  - directory transfer . . . . . 130
  - DTMF-reminder for VoIP . . . . . 122
  - firmware update . . . . . 132
  - interface language . . . . . 105
  - IP configuration . . . . . 109
  - local network . . . . . 109
  - menu . . . . . 25
  - messenger access data . . . . . 126
  - name of a VoIP connection . . . . . 112
  - name/provider of a connection . . . 111
  - number assignment . . . . . 120, 121
  - opening Web page . . . . . 107
  - phone status . . . . . 135
  - preferred DNS server . . . . . 109
  - remote access . . . . . 110
  - selecting IP address type . . . . . 109
  - setting phone . . . . . 108
  - specifying dialling plans . . . . . 124
  - status of a VoIP connection . . . . . 111
  - structure of the Web pages . . . . . 106
  - subnet mask . . . . . 109
- Web interface, see Web configurator
- Web page (Web configurator)
  - opening . . . . . 107
  - structure . . . . . 106
- Web server, see Web configurator
- Wide Area Network . . . . . 169
- Withhold number display . . . . . 37
- Withhold phone number display . . . . . 37
- Working area (Web configurator) . . . 107
- Writing (SMS) . . . . . 54
- Writing, editing text . . . . . 147

## Mounting the charging cradle to the wall, connecting the charging cradle

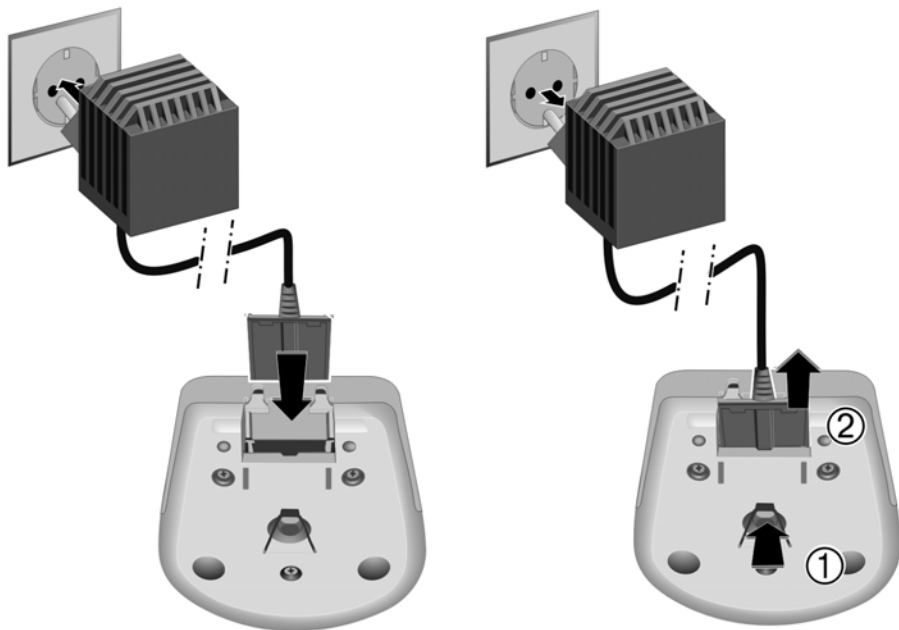
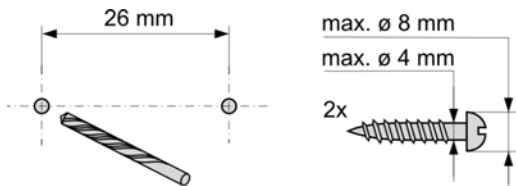



# Mounting the base station to the wall

---

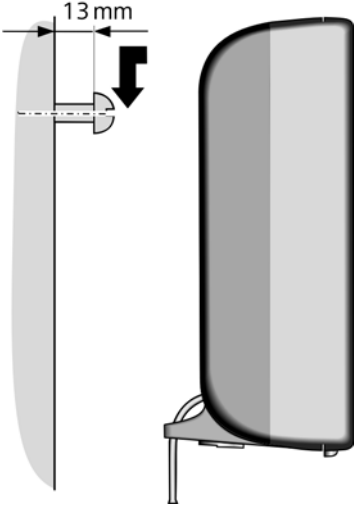
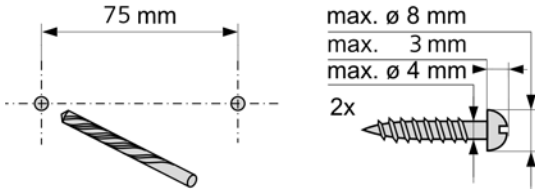

Issued by  
Siemens Home and Office Communication Devices GmbH & Co. KG  
Schlavenhorst 66  
D-46395 Bocholt

© Siemens Home and Office Communication Devices GmbH & Co. KG 2008  
All rights reserved. Subject to availability.  
Rights of modification reserved.

[www.siemens.com/gigaset](http://www.siemens.com/gigaset)