

Doro PhoneEasy® 520X

English

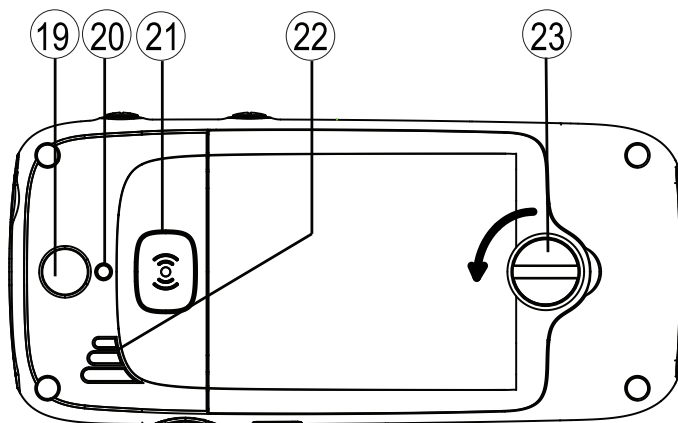

doro 

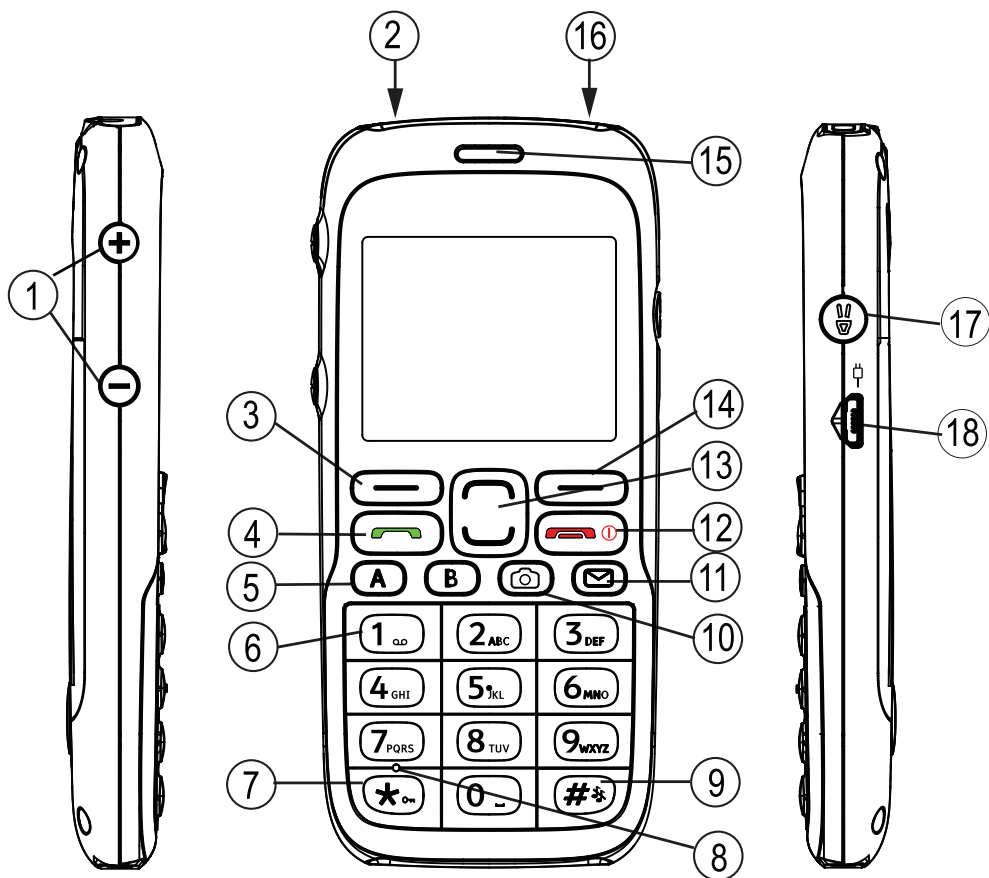





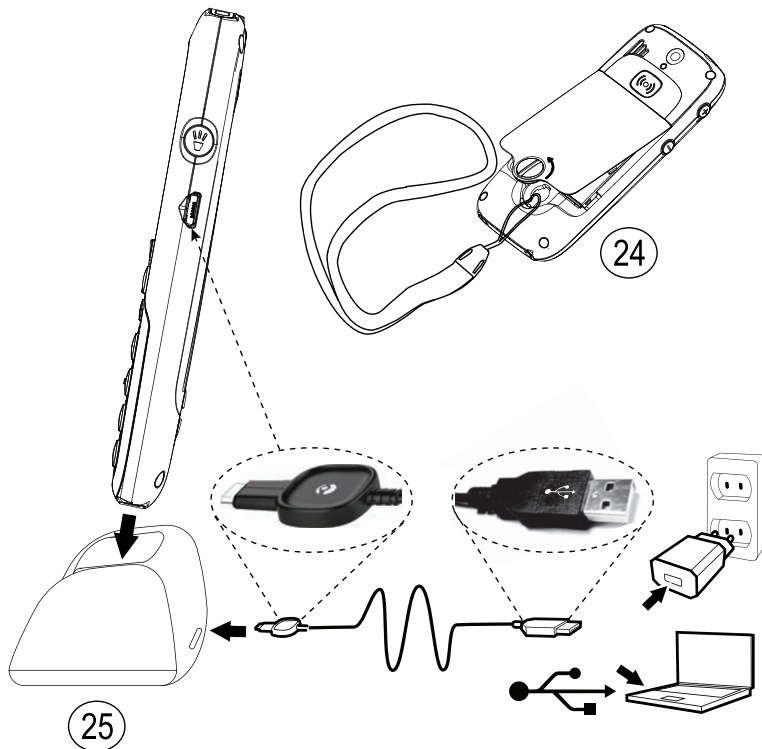

English

1. Volume control
2. Headset socket
3. Left selection button
4. Call button
5. Speed dial
6. Voice mail
7. Key lock
8. Microphone
9. Silent/Input method
10. Camera shortcut
11. SMS shortcut
12. End call/**Power on/off**
13. Arrow buttons
14. Right selection button
15. Earpiece
16. Torch
17. Torch button
18. Charging socket
19. Camera lens
20. Camera flash
21. Assistance button
22. Loudspeaker
23. Battery cover/lock
24. Lanyard
25. Charging stand



Contents

Installation	1
Installing the SIM card, memory card and the battery	1
Charging	2
Symbols	3
Assistive functions	3
Display status symbols	3
Display main symbols.....	4
Operation.....	5
Activating the phone	5
Making a call.....	6
Making a call from the Phonebook.....	6
Receiving a call	6
Volume control.....	6
Entering text 	6
Call options	7
Call waiting	8
Call information	8
Speed dial 	9
Key lock.....	9
Silent.....	9
Headset	9
SOS calls	9
Assistance button 	10
Phonebook.....	12
Creating a phonebook entry.....	12
Creating ICE entry (In Case of Emergency) 	12
Managing phonebook entries.....	12
ICE (In Case of Emergency) 	14
Messages	15
Creating and sending SMS.....	15
Creating and sending voice message.....	16
Creating and sending MMS	16
Inbox, Sent, Outbox	17
Call log.....	19
Retrieving and dialling.....	19
Camera (take photos).....	19

Camera, options.....	20
Camera adjustments.....	20
Image viewer.....	20
Image viewer, options.....	21
Connecting the phone to a computer.....	22
Drag and drop content between phone and a computer.....	22
Disconnect the USB cable safely.....	23
Settings.....	23
General.....	23
Sound.....	27
Display.....	29
Calls.....	30
Messages.....	35
Camera.....	38
Assistance 	39
Bluetooth®.....	41
Security.....	42
File manager.....	45
Additional functions.....	47
Alarm.....	47
Organizer.....	47
Calculator.....	48
FM radio.....	49
Status.....	51
Instructions for the REMOTE USER.....	51
Troubleshooting.....	55
Safety instructions.....	56
Network services and costs.....	57
Operating environment.....	57
Medical units.....	57
Areas with explosion risk.....	58
Li-ion battery.....	58
Protect your hearing.....	58
Emergency calls.....	59
Vehicles.....	59
Care and maintenance.....	60
Warranty.....	60
Specifications.....	60

Hearing aid	61
Specific Absorption Rate (SAR)	61
Declaration of Conformity	61

Installation

IMPORTANT!

Turn off the phone and disconnect the charger before removing the battery cover.

Installing the SIM card, memory card and the battery

The SIM and memory card holder's are located inside the battery compartment.

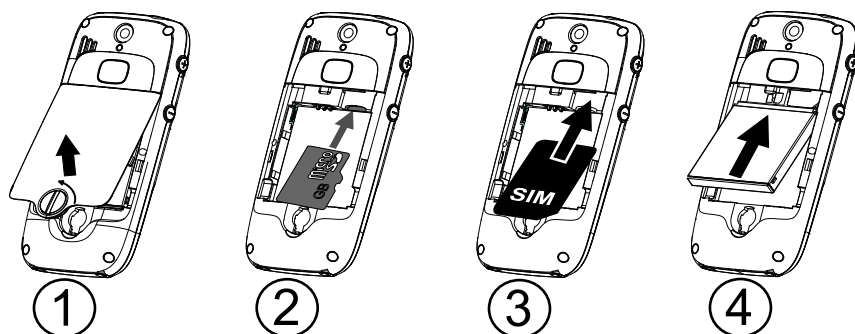

1. Remove the battery cover and the battery if it is already installed. Unlock the battery cover by turning the screw a quarter of a turn counter clockwise.
2. Optional: Insert the memory card into the slot under the SIM card holder. Make sure that the memory card contacts are facing inwards and push the card in, until you hear a click. Take care not to scratch or bend the contacts on the card. To remove or replace the card, push the card in until you hear a click and then pull the card out.
3. Insert the SIM card by gently sliding it into the holder. Make sure that the SIM card's contacts are facing inwards and that the cut off corner is pointing downwards. Take care not to scratch or bend the contacts on the SIM card.
4. Insert the battery by sliding it into the battery compartment with the contacts facing upwards to the left. Replace the battery cover and lock it by turning the screw a quarter of a turn clockwise.



IMPORTANT!



Use only compatible memory cards for use with this device. Compatible card type: **microSD, microSDHC**.

Incompatible cards may damage the card itself, the device and corrupt data stored on the card. Depending on the market some phones may have a pre-installed memory card.

Charging**⚠ CAUTION**

Only use batteries, charger and accessories that have been approved for use with this particular model. Connecting other accessories may be dangerous and may invalidate the phones type approval and guarantee.

When the battery is running low,  is displayed and a warning signal is heard. To charge the battery, connect the mains adapter to a wall socket and to the charging socket .

 is displayed briefly when the charger is connected to the phone, and  when it is disconnected. The battery charge indicator will be animated while charging. It takes approximately 3 hours to fully charge the battery.

 is displayed on the screen when charging is completed. If the phone is turned off when the charger is connected to the phone only the battery charge indicator will be shown on the display.

Note!

To save power the LCD backlight goes off after a while. Press any button to illuminate the display. Full battery capacity will not be reached until the battery has been charged 3–4 times. Batteries degrade over time, which means that call time and standby time will normally decrease with regular use.





Save energy

When you have fully charged the battery and disconnected the charger from the device, unplug the charger from the wall outlet.

















Symbols

Assistive functions























The following symbols indicate information in the manual about assistive functions for:

	Seeing		Handling
	Hearing		Safety

Display status symbols

	Signal strength		No network coverage
	Ring only		Unread message in Inbox
	Ring + vibration		Alarm active
	Vibration only		Battery level
	Silent		Call forward activated
	Roaming (in other network)		Bluetooth on, visible to others
	Missed call		Bluetooth on, invisible to others
	Headset connected		Bluetooth connected
	Voice mail message received		



Display main symbols

	Mute		Charger connect
	Message sending success		Charger removed
	Message sending failed		Headset in
	Error		Headset out
	Warning		Speaker on
	Query		Speaker off
	Done (confirmed)		Incoming call
	New message		Outgoing call
	Battery level low		Call ended
	Searching		Missed call. Press Read to see the missed calls.
	Emergency call		Call on-hold
	vCard message		SOS calls only
	Volume control		Processing, please wait

Operation

Activating the phone

Press and hold the red button  on the phone to turn it on/off. Confirm with **Yes** to power off.

If the SIM card is valid but protected with a PIN code (Personal Identification Number), **PIN** is displayed. Enter the PIN code and press **OK** ( upper left corner of keypad). Delete with **Clear** ( upper right corner of keypad).

Note!

If PIN and PUK codes were not provided with your SIM card, please contact your service provider.

Attempts: # shows the number of PIN attempts left. When no more attempts remain, **PIN blocked** is displayed. The SIM card must now be unlocked with the PUK code (Personal Unblocking Key).

1. Enter the PUK code and confirm with **OK**.
2. Enter a new PIN code and confirm with **OK**.
3. Re-enter new PIN code and confirm with **OK**.

Start-up wizard

When starting the telephone for the first time, you can use the Start-up wizard to set some basic settings.

Press **Yes** to change or **No** if you do not want to change.

Tip:

You can run the Start-up wizard later if you want, see [Start-up wizard, p.24](#).

Standby (Idle mode)

When the phone is ready to use, and you have not keyed in any characters, the phone is in standby.

Left selection button in standby is **Menu**.

Right selection button in standby is **Name**.



Tip:

You can always press  to return to standby.

Changing the language, time and date

The default language is determined by the SIM card. See [General, p.23](#) on how to change language, time and date.



Making a call

1. Enter the phone number including the area code. Delete with **Clear**.
2. Press  to dial. Press **Abort** to cancel dialling.
3. Press  to end the call.



Tip:

For international calls, always use **+** before the country code for best operation. Press  twice for the international prefix **+**.

Making a call from the Phonebook

1. Press **Name** to open the phonebook.
2. Use the arrow buttons / to scroll through the phonebook, or quick search by pressing the key corresponding to the first letter of the entry, see [Entering text !\[\]\(8fd54d112e752061b5361c5bdf346185_img.jpg\)](#), p. 6.
3. Press **Call** to dial the selected entry, or press **Back**.

Receiving a call

1. Press  to answer, or press **Silent** to switch off the ring signal and then **Reject** to reject the call (busy signal). Alternatively, press  to reject the call directly.
2. Press  to end the call.

Volume control

Use the side buttons **+/-** to adjust the sound volume during a call. The volume level is indicated on the display. If you use hearing aid or have hearing difficulties when using the telephone in noisy environment, you can customize the phone's audio settings, see [Audio setup !\[\]\(fe3aebe81acea8d45108cd2768939da7_img.jpg\)](#), p.27.

Entering text

Press a numerical key repeatedly until the desired character is shown. Wait a few seconds before entering the next character.

Press ***** for a list of special characters. Select the desired character with **▼/▲** and press **OK** to enter it.

Use the side keys **+/-** or **▼/▲** to move the cursor within the text.

Press **#** to cycle upper case, lower case and numerals.

Press and hold **#** to change input language.

Entering text with predictive text

In some languages you can use the Smart ABC (eZiType™) input method which uses a dictionary to suggest words. See [Predictive text](#) , [p.35](#) on how to activate predictive text.

Press each key **once**, even if the displayed character is not the one you want. The dictionary will suggest words based on the keys you have pressed.

1. To write the word “**Fred**”, press **3**, **7**, **3**, **3**. Complete the word before looking at the suggestions.
2. Use **▼/▲** to view the suggested words.
3. Press **Select** and continue with the next word.
Alternatively, press **0** to continue with the next word.

If none of the suggested words are correct, use manual input mode.

The icon on the top left of the display indicates the input mode:

<input checked="" type="checkbox"/> Abc	Sentence case with predictive text
<input checked="" type="checkbox"/> ABC	UPPER CASE with predictive text
<input checked="" type="checkbox"/> abc	lower case with predictive text
Abc	Sentence case
ABC	UPPER CASE
abc	lower case
123	Numerals

Call options

During a call the selection buttons¹ () give access to additional functions:

1. selection buttons have multiple functions. The current key function is shown above the selection button on the display.

Options (left selection button)

A menu with the following options is displayed:

Hold single call/Retrieve single	Hold/retrieve the current call.
End single call	End the current call (same as ).
New call	Call another number (Conference).
Phonebook	Search the phonebook.
Messages	Write or read SMS messages.
Mute	Disable the microphone.

SPK on (right selection button)

Activates handsfree mode, which allows you to speak without holding the phone. Speak clearly into the microphone at a maximum distance of 1 m. Use the side keys **+/-** to adjust the loudspeaker volume. Press **SPK off** to return to normal mode.

Note!

The handsfree function allows only one person at a time to talk. Switching between talk/listen is triggered by the sound of the person talking. Loud noises (music, etc.) in the background may interfere with the function.

Call waiting

An alert tone will be heard if there is an incoming call while talking. To put the current call on hold and answer the incoming call, press **Options**, select **Answer** and then **OK**.

Tip:

Call waiting must be activated, see [Call setup, p.33](#).

Call information

During a call, the outgoing or incoming phone number and the elapsed call time is displayed. If the identity of the caller is withheld, **Unknown** is displayed.

Speed dial

You can use keys **A** and **B** and you can also use the numerical keys **0** and **2–9**. To speed dial an entry from standby, press and hold the corresponding key. See [Speed dial !\[\]\(d84e7ea36f695d92cb39ec32c307ac93_img.jpg\) , p.31](#).

Key lock

You can lock the keypad to prevent the keys being accidentally pressed, for example, when your phone is in your handbag.

Press and hold ***** to lock/unlock the keypad.

Incoming calls can be answered by pressing  even if the keypad is locked. During the call, the keypad is unlocked. When the call is ended or rejected, the keypad is locked again. See [Keypad lock, p.43](#).

Note!

The emergency number can be dialled without unlocking the keypad.

Silent

Silent is a fixed profile with Keypad tone, Message tone and Ring tone disabled, while Vibration, Tasks and Alarm are unchanged.

Tip:

*Press and hold shortcut button **#** to activate/deactivate Silent.*

Headset

When a headset is connected, the internal microphone in the phone is automatically disconnected.

When receiving a call you can use the answer key on the headset cable (if it has one) to answer and end calls.

CAUTION

Using a headset at high volume may damage your hearing. Adjust the volume level carefully when using a headset.

SOS calls

As long as the phone is switched on, it is always possible to place an SOS call by entering the main local emergency number for your present location followed by .

Some networks accept calls to emergency numbers without a valid SIM card. Contact your service provider for more information.

Assistance button +



IMPORTANT!

Always inform recipients in the **Number list** that they are listed as your assistance contacts.

CAUTION

When an assistance call is activated the phone is pre-set to handsfree/speakerphone mode. Do not hold the device near your ear when the handsfree mode is in use, because the volume may be extremely loud.

The Assistance button allows easy access to contact your predefined help numbers (Number list) should you need help. The Assistance function may need to be activated before use. See [Assistance +, p.39](#) on how to activate as described or with 3 button presses, how to enter recipients in the numbers list, and how to edit the text message.

- Press and hold the Assistance button for 3 seconds, or press it twice within 1 second. The assistance call begins after a delay of 5 seconds. In this time you can prevent a possible false alarm by pressing .
- An assistance SMS is sent to all recipients.
- The first recipients in the list is dialled. If the call is not answered within 25 seconds, the next number is dialled. Dialling is repeated 3 times or until the call is answered, or until  is pressed.
- The assistance function may be configured so that the receiver of the call must press "0" (zero) to confirm, in order to stop the alarm sequence. If there is a risk that the assistance call will be answered by a voice mail/answering service, please activate the function Confirm with "0". See [Confirm with "0", p.40](#).

Note!

Some private security companies can accept automatic calls from their clients. Always contact the security company before using their phone number.

IMPORTANT!









Information to the receiver of an assistance call, when Confirm with "0" is activated:

- After receiving the assistance message, each number in the Number list will be called sequentially.
- To confirm the assistance call, the receiver needs to press **0**.
- If the receiver doesn't press **0** within 60 seconds (after answering) the call will be disconnected and the next number in sequence will be called.
- If the receiver presses **0** within 60 seconds, the call is confirmed and no further call attempts will be made (assistance sequence interrupted).

Phonebook

The phonebook can store 300 entries with 3 phone numbers in each entry.

Creating a phonebook entry

1. Press **Menu**, scroll to  and press **OK**.
2. Select **-New contact-** and press **Add**.
3. Enter a  **Name** for the contact, see [Entering text](#) , [p. 6](#) .
Delete with **Clear**.
4. Use / to select  **Mobile**,  **Home** or  **Office**, and enter the phone number(s) including the area code.
5. Select  **Picture** and press **Edit** to associate a picture to the contact.
This picture will be displayed when the corresponding contact is calling you and may also be visible in the phonebook, see [Phonebook picture, p.27](#).
 - Select **Take picture** and press **OK** for using the camera to take a picture.
 - Select **My pictures** and press **OK** to select an existing picture.
6. Press **Save**.

Tip:

For international calls, always use + before the country code for best operation. Press  twice for the international prefix +.

Creating ICE entry (In Case of Emergency) +

With this additional information and medical information, first responders can access this information from the victim's phone in case of emergency. In the event of a trauma, it is critical to have this information as early as possible which can increase the chances of survival. All fields are optional, but the more information provided the better. See [ICE \(In Case of Emergency\) +](#), [p.14](#) on how to configure your ICE information.

Managing phonebook entries



1. Press **Menu**, scroll to  and press **OK**.

2. Select a contact and press **Options**.
3. Select one of the following options and press **OK**.

View

Show details for the selected contact.

Edit

1. Use / to move the cursor. Delete with **Clear**.
2. Press **Save**.

Add

See [Creating a phonebook entry, p.12](#).

Call

Press **OK** to call the contact.

Top 10

Press **OK** to set the entry as one of the first 10 contacts listed in the phonebook, see [Top 10 !\[\]\(4fe57c3593bf1b21d272ae7ac8dfaf77_img.jpg\) , p.31](#).

Send SMS

Press **OK** to write a SMS message, see [Creating and sending SMS, p.15](#).

Send MMS

Press **OK** to write a MMS message, see [Creating and sending MMS, p.16](#).

Delete

Press **OK** to delete the selected phonebook entry. Press **Yes** to confirm or **No** to abort.

Delete all

Select **From SIM** or **From phone** and press **OK** to delete all phonebook entries from the SIM card or phone memory.



Enter the phone code and press **OK** to confirm. The default phone code is **1234**.

Copy all

Select **From SIM** and press **OK** to copy all phonebook entries from the SIM card to the phone memory. Press **Yes** to confirm or **No** to abort.

Select **From phone** and press **OK** to copy all phonebook entries from the phone memory to the SIM card. Press **Yes** to confirm or **No** to abort.

Send vCard





Select **Send by SMS** and press **OK** to send the selected phonebook entry as a vCard via SMS. Enter the phone number of the recipient. Alternatively use the arrow keys / to scroll through the phonebook, or quick search by pressing the key corresponding to the first letter of the entry, see [Entering text](#) , [p. 6](#) . Press **OK** to send.

Select **Send by MMS** and press **OK** to send the selected phonebook entry as a vCard via MMS. Type your message, then press **Options**. Add items to your message from the options **Add subject** and **Add picture**. Add recipients with **To** and **Send** when ready.

Select **Send by Bluetooth** and press **OK** to send the selected phonebook entry as a vCard via Bluetooth®. See [Bluetooth®](#), [p.41](#) on how to connect with Bluetooth.

ICE (In Case of Emergency) +

First responders can access additional information such as medical information from the victim's phone in case of emergency. In the event of a trauma, it is critical to have this information as early as possible to increase the chances of survival. All fields are optional, but the more information provided the better.

1. Press **Menu**, scroll to  and press **OK**.
2. Select **+ICE** and press **OK**, then use / to scroll the list of entries.
3. Press **Edit** to add or edit information in each entry, see [Entering text](#) , [p. 6](#) . Delete with **Clear**. Press **Save** when done.

Name:	Your own name.
Birth:	Your date of birth.



Height:	Your height.
Weight:	Your weight.
Language:	Your language.
Insurance:	Your insurance provider and policy number.
Contact 1: Contact 2: Doctor:	Press Options and then OK to Add or Delete a contact from the phonebook, or Save to accept the current entry. If possible, add your relationship to your ICE contacts in the phonebook, such as "ICE Wife Mary Smith".
Condition:	Any medical conditions/medical devices (e.g. diabetic, pacemaker).
Allergies:	Any known allergies (e.g. penicillin, bee stings).
Blood type:	Your blood type.
Vaccination:	Any relevant vaccination.
Medication:	Any medication that you are treated with.
Other info:	Other information (e.g. organ donor, living will, consent to treat).

Messages

Creating and sending SMS

Note!

Before you can send any SMS, you need to save your message centre number. The number to your service centre is supplied by your service provider and is usually set on the SIM card. If not, you can enter the number yourself. See [Profile set, p.35](#).



1. Press shortcut button  or press **Menu**, scroll to  and press **OK**.
2. Select **SMS** and press **OK**.
3. Type your message, see [Entering text](#) , [p. 6](#), then press **To**.
4. Select a recipient from **Phonebook** and press **OK**.
Alternatively, select **Enter number** and press **OK** to add recipient manually and press **Done**.
5. Select **Add** to add more recipient or select **Send** to send and then press **OK**.
6. You can also modify the recipients by selecting one and press **Options** to **Edit**, **Delete** or **Edit**.

Note!

If you choose to add multiple recipients, you will be charged for each recipient (maximum 10). For international calls, always use + before the country code for best operation. Press * twice for the international prefix +.

Creating and sending voice message

A voice message use the same technology as a MMS. Both you and the recipient must have subscriptions that support MMS. The settings for MMS is supplied by your service provider and can be sent to you automatically via SMS. If not, see [MMS settings, p.36](#) on how to set your MMS profile.



1. Press shortcut button  or press **Menu**, scroll to  and press **OK**.
2. Select **Voice message** and press **OK**.
3. Recording will start immediately. Press **Stop** when done and press **Yes** to save.
4. Select an already added recipient from **Phonebook** and press **OK**. Alternatively, select **Enter number** and press **OK** to add recipient manually and press **Done**.
5. Select **Add** to add more recipient or select **Send** to send and then press **OK**.
6. You can also modify the recipients by selecting one and press **Options** to **Edit**, **Delete** or **Delete all**.

Note!

If you choose to add multiple recipients, you will be charged for each recipient (maximum 10). For international calls, always use + before the country code for best operation. Press * twice for the international prefix +.

Creating and sending MMS

A MMS message can contain text and media objects such as pictures, sound recordings and video. Both you and the recipient must have subscriptions that support MMS. The settings for MMS is supplied by your service provider and can be sent to you automatically via SMS. If not, see [MMS settings, p.36](#) on how to set your MMS profile.

1. Press shortcut button  or press **Menu**, scroll to  and press **OK**.
2. Select **MMS** and press **OK**.
3. Type your message, see [Entering text](#) , p. 6 , then press **Options**.
4. Select **Add picture** to add items to your message, or select **Add subject** to enter subject.
5. Add recipients with **To** and **Send** when ready.

Add picture

1. Select **Add picture** and press **OK**.
2. Select **My pictures** and press **OK**
Alternatively, select **Take picture** and press **OK** for using the camera to take a picture.
3. Select a file and press **OK**.









Add subject



1. Select **Add subject** and press **OK**.
2. Type your subject, then press **Done**.

Add recipients (To)

1. Select **To** and press **OK** to select recipient from **Phonebook** and press **OK**.
Alternatively, select **Enter number** and press **OK** to add recipient manually and press **Done**.
2. Select **Add** to add more recipient or select **Send** to send and then press **OK**.
3. You can also modify the recipients by selecting one and press **Options** to **Edit**, **Delete** or **Delete all**.

Inbox, Sent, Outbox

 / 	SMS/MMS unread	 / 	SMS/MMS sent
 / 	SMS/MMS read	 / 	SMS/MMS unsent

1. Press **Menu**, scroll to  and press **OK**.
2. Select **Inbox/Sent/Outbox** and press **OK**.
3. Select a message and press **Read**.
Use  /  to scroll the message up/down.

4. Press **Options** for the following options:

View (MMS only)

To view the message.

Call

Press **OK** to call the contact.

Resend

Send again to the same receiver.

Reply

Type your reply, then press **Send**. The message will be sent immediately.

Delete

Press **Yes** to delete the message, or **No** to return.

Download/Cancel download

If the message is not downloaded yet, press **Download**.

Edit

Edit the message, then press **Send**.

Forward

Forward a message. Edit the message (if desired), then press **Send**.

Use number

Displays all phone numbers contained in the message as well as the sender's number.

Call	Call the selected number.
Save	Save the number in the Phonebook.
Send SMS	Write a new SMS message.
Send MMS	Write a new MMS message.

Save objects (MMS only)

To save text and media objects such as pictures, sound recordings and video.









Details (MMS only)

To view details of the message.

Call log

Received, missed, and dialled calls are saved in a combined call log. 20 calls of each type can be stored in the log. For multiple calls related to the same number, only the most recent call is saved.



Retrieving and dialling

- Press .
Alternatively, press **Menu**, scroll to  and press **OK**.
- Use / to scroll through the **Call log**.
 -  Received call
 -  Dialled call
 -  Missed call
- Press  to dial the number or press **Options** for the following settings:

View	Show details for the selected call.
Delete	Delete the call.
Delete all	Delete all calls in the Call log.
Save	Save the number in the Phonebook.

Camera (take photos)

To get sharp photos, wipe the lens clean with a dry cloth.

- Press shortcut  or press **Menu**, scroll to  and press **OK**.
- Press  to take photo.
- Press **Options** or **Back** (if you do not make any selection the picture is saved).

Camera, options

Send

Select an option, then press **OK**:

Send by MMS	Send as MMS. Press OK to create a message, see Creating and sending MMS, p.16 .
Send by Bluetooth	Send to other Bluetooth devices, see Bluetooth®, p.41 .

Delete



Press **OK** to delete selected image. Press **Yes** to confirm or **No** to return.

Use

Select an option from the list, then press **OK**.

Wallpaper	Save as display background. Press OK
Phonebook picture	Save as phonebook contact. Press OK .

Camera adjustments

- Use / to zoom in and out.
- Use the side buttons **+/-** to adjust EV/Light sensitivity.

Note!

Zoom may reduce image quality.

For more camera settings, see [Camera, p.38](#).

Image viewer

View your saved images.

1. Press **Menu**, scroll to  and press **OK**.
2. Select an image, then press **Options**.
3. Select one of the following options and press **OK**.

Image viewer, options

View

Single view. Press **Back** when done.

Send

Select an option, then press **OK**:

Send by MMS	Send image as MMS. Press OK to create a message, see Creating and sending MMS, p.16 .
Send by Bluetooth	Send image to other Bluetooth devices, see Bluetooth®, p.41 .

Delete

Press **OK** to delete selected image. Press **Yes** to confirm or **No** to return.

Use

Select an option from the list, then press **OK** to confirm.

Wallpaper	Save as display background. Press OK .
Phonebook picture	Save as phonebook contact. Press OK .

Details

View detailed information about the file, e.g. date, size, copyright.

Rename

Rename image. Delete with **Clear** and press **Done** to confirm.

Browse style

You can change image view. Default is **Large**, you can also select **List** or **Medium**.

In **List** the file name, the date and the size of the image is shown.

Sort by

Select if you want to sort your images by **Name** or **Time**.

Storage

Select where the phone should save files if you have memory card installed.

Delete all

Press **OK** to delete all images. Press **Yes** to confirm or **No** to return.

Connecting the phone to a computer

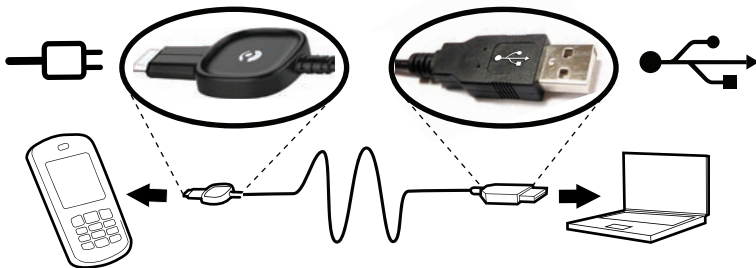

Connect the phone to a computer and start transferring pictures, music and other file types. All you have to do is connect a USB cable between the phone and computer. From your computer's file explorer, you can drag and drop content between your phone and the computer.

Note!

You might not be able to transfer some copyright-protected material.

Drag and drop content between phone and a computer

1. Connect your phone to a computer using a USB cable.
2. Wait until the phone/memory card appears as external disks in the file explorer.
3. Drag and drop selected files between the phone and the computer.

Note!

When the phone/memory card is mounted to the computer, the phone cannot access the memory card. Some functionality and applications in the phone, such as the camera, may not be accessible.

You can transfer files by using a USB cable on most devices and operating systems supporting a USB Mass Storage interface.

Disconnect the USB cable safely

1. Make sure to enable the hardware to be safely removed.
2. Disconnect the USB cable.

Note!

Do not disconnect the USB cable when transferring content as this may corrupt the content.

Computer instructions may vary depending on your operating system. See the documentation of your computer's operating system for more information.

Settings

Note!

The settings described in this chapter are carried out in standby mode. Press  to return to standby mode.

General

Time & date

Setting the time and date

1. Press **Menu**, scroll to  and press **OK**.
2. Select **General** and press **OK**.
3. Select **Time & date** and press **OK**.
4. Select **Set time** and press **OK**.
5. Enter the time (**HH:MM**), then press **OK**.
6. Select **Set date** and press **OK**.
7. Enter the date (**DD/MM/YYYY**), then press **OK**.

Setting the time/date format

1. Press **Menu**, scroll to  and press **OK**.
2. Select **General** and press **OK**.
3. Select **Time & date** and press **OK**.
4. Select **Set format** and press **OK**.
5. Select **Time format** and press **OK**.
6. Select **12 hours** or **24 hours** and press **OK**.
7. Select **Date format** and press **OK**.
8. Select the desired date format and press **OK**.



Setting Auto time on/off

1. Press **Menu**, scroll to  and press **OK**.
2. Select **General** and press **OK**.
3. Select **Time & date** and press **OK**.
4. Select **Auto time** and press **OK**.
5. Select **On/Off** and press **OK**.

To set the phone to automatically update the time and date according to the current time zone, select **On**. Automatic update of date and time does not change the time you have set for the alarm clock or the calendar. They are in local time. Updating may cause some alarms you have set to expire. Depending on network support and subscription.

Language

The default language for the phone menus, messages etc. is determined by the SIM card. You can change this to any other language supported by the phone.

1. Press **Menu**, scroll to  and press **OK**.
2. Select **General** and press **OK**.
3. Select **Language** and press **OK**.
4. Scroll / to select a language, then press **OK**.

Start-up wizard

Use the Start-up wizard to set some basic settings.

Press **Yes** to change or **No** if you don't want to change.

- Language
- Time & date
- Display settings such as Themes, Text size or Wallpaper.
- Sound settings such as Ring tone, Volume, or Audio setup.
- Messages settings such as Predictive text and Write speed.

Owner number

The phone numbers assigned to your SIM card are saved in Owner number if this is allowed by the card.

To view/edit or the numbers:

-
1. Press **Menu**, scroll to  and press **OK**.
 2. Select **General** and press **OK**.
 3. Select **Owner number** and press **OK**.

See *Phonebook, p.12* on how to add names/numbers.

To edit or delete an existing entry, select it and press **Options**, then select **Edit** or **Delete** and press **OK**.

Block function

You can disable functions to simplify use of the phone.

1. Press **Menu**, scroll to  and press **OK**.
2. Select **General** and press **OK**.
3. Select **Block function** and press **OK**.
4. Select each function you want to disable and press **Off**.
5. Press **Done** to confirm.

Network setup

Your phone automatically selects your (service provider's) home network if this is within range. If not within range, you may use another network, provided your network operator has an agreement that allows you to do so. This is called roaming. Contact your service provider for more information.

1. Press **Menu**, scroll to  and press **OK**.
2. Select **General** and press **OK**.
3. Select **Network setup** and press **OK**.
4. Select one of the following options and press **OK** to confirm.

New search

Perform new search if connection is lost.

Select network

To view available network, press **Select network**. A list of available network operators is displayed (after a short delay). Select desired operator and press **OK**.

Network mode

To select another network, select **Network mode** and then select one of the following options.

Automatic	Network is selected automatically.
Manual	Network is selected manually. Use Select network to select desired operator.

Services

This menu may contain pre-programmed services from your network provider. Depending on network support and subscription.

1. Press **Menu**, scroll to  and press **OK**.
2. Select **General** and press **OK**.
3. Select **Services** and press **OK**.

Torch

Set the automatic switch off time for the built in torch.

1. Press **Menu**, scroll to  and press **OK**.
2. Select **General** and press **OK**.
3. Select **Torch** and press **OK**.
4. Select one of the following options and press **OK**.

1 min	Turns off automatically after 1 min
2 min	Turns off automatically after 2 min
No limit	No automatic turn off

Note!

The torch will drain the battery very quickly. Remember to turn off the torch after use.

Phonebook storage

1. Press **Menu**, scroll to  and press **OK**.
2. Select **General** and press **OK**.
3. Select **Phonebook storage** and press **OK**.
4. Select one of the following options and press **OK**.

SIM	1 phone number per contact. Number and length of the phone numbers/contacts that can be stored will vary depending on SIM card/service provider preferences.
Phone	300 contacts with 3 phone numbers each Mobile, Home or Office .

Phonebook picture

You can change the phonebook view mode. Select **On** to see the contacts associate picture (**Picture**), or select **Off** to display only the names of contacts.

1. Press **Menu**, scroll to  and press **OK**.
2. Select **General** and press **OK**.
3. Select **Phonebook picture** and press **OK**.
4. Select **On** or **Off** and press **OK**.

Sound

Note!

Silent needs to be set to **Off** to access *Tone setup*, *Volume*, *Alert type* and *Extra tone*. See [Silent, p.28](#).



Audio setup

If you use a hearing aid or have hearing difficulties when using the telephone in a noisy environment, you can customize the phone's audio settings.

1. Press **Menu**, scroll to  and press **OK**.
2. Select **Sound** and press **OK**.
3. Select **Audio setup** and press **OK**.
4. Select one of the following options and press **OK**.



Normal	For normal hearing in normal conditions.
Medium	For mild hearing impairment or usage in noisy environment.
High	For moderate hearing impairment or usage in very noisy environment.

Tone setup

1. Press **Menu**, scroll to  and press **OK**.
2. Select **Sound** and press **OK**.
3. Select **Tone setup** and press **OK**.
4. Select **Ring tone** and press **OK**.
5. Scroll / to select one of the available melodies, the melody will be played. Press **OK** to confirm or **Back** to discard changes.

- Set up the **Alarm, Message tone, Keypad tone, Power on** and **Power off** in the same way.

Ringtone volume

- Press **Menu**, scroll to  and press **OK**.
- Select **Sound** and press **OK**.
- Select **Volume** and press **OK**.
- Scroll / to change the ring volume, then press **OK**.

Silent



- Press **Menu**, scroll to  and press **OK**.
- Select **Sound** and press **OK**.
- Select **Silent** and press **OK**.
- Select **On** or **Off** and press **OK**.

Tip:

Press and hold shortcut button  to activate/deactivate Silent.

Alert type

Incoming calls can be signalled by a ring tone and/or vibration.

- Press **Menu**, scroll to  and press **OK**.
- Select **Sound** and press **OK**.
- Select **Alert type** and press **OK**.
- Scroll / to select signalling mode, then press **OK**.

Ring only	Ring tone only.
Vib. only	Vibration only.
Vib. and ring	Vibration and ring tone.
Vib. then ring	Starts with vibration and adds ring tone after a short while.
Silent	No sound or vibration, the display light is lit.

Extra tone

Warning and error tones are used to alert you of low battery power, phone and SIM card errors, etc.



- Press **Menu**, scroll to  and press **OK**.
- Select **Sound** and press **OK**.

3. Select **Extra tone** and press **OK**.
4. Select **Warning** and press **On/Off** to enable/disable.
5. Select **Error** and press **On/Off** to enable/disable.
6. Press **Done** to save.

Display

Wallpaper

You can select different display backgrounds.

1. Press **Menu**, scroll to  and press **OK**.
2. Select **Display** and press **OK**.
3. Select **Wallpaper** and press **OK**.
4. Scroll / to display available wallpapers.
5. Press **OK** to confirm or **Back** to discard changes.

Text size

You can customize the text size for messages and the phonebook.

1. Press **Menu**, scroll to  and press **OK**.
2. Select **Display** and press **OK**.
3. Select **Text size** and press **OK**.
4. Select **Normal** or **Large** and press **OK**.

Idle display



In standby mode the display can show clock only, clock and the service provider, or all information.

1. Press **Menu**, scroll to  and press **OK**.
2. Select **Display** and press **OK**.
3. Select **Idle display** and press **OK**.
4. Select **Clock only**, **Clock & Operator** or **All info** and press **OK**.

Themes

You can select different themes to personalise the phone's texts and background.

1. Press **Menu**, scroll to  and press **OK**.
2. Select **Display** and press **OK**.
3. Select **Themes** and press **OK**.

-
4. Scroll / to select a theme.
 5. Press **OK** to confirm or **Back** to discard changes.

LCD backlight

Select the delay time for the display backlight.

1. Press **Menu**, scroll to  and press **OK**.
2. Select **Display** and press **OK**.
3. Select **LCD backlight** and press **OK**.
4. Select **15 sec.**, **30 sec.** or **1 min** and press **OK**.

Brightness

You can customize the phone's brightness settings.

1. Press **Menu**, scroll to  and press **OK**.
2. Select **Display** and press **OK**.
3. Select **Brightness** and press **OK**.
4. Select **Level 1–Level 3** and press **OK**.

Calls

Voice mail

If your subscription includes an answering service, callers can leave a voice mail message when you cannot answer a call. **Voice mail** is a network service and you may need to subscribe to it first. For more information and for the voice mail number, contact your service provider.

1. Press **Menu**, scroll to  and press **OK**.
2. Select **Calls** and press **OK**.
3. Select **Voice mail** and press **OK**.
4. Select **Empty** and press **Add**.
5. Select **Phonebook** to add a contact from the Phonebook.
Alternatively, press **Manual**. See [Phonebook, p.12](#) on how to add names/numbers.
6. Press **OK**.

To edit or delete an existing entry, select it and press **Options**, then select **Edit** or **Delete** and press **OK**.

Call voice mail

1. Press **Menu**, scroll to  and press **OK**.
2. Select **Calls** and press **OK**.
3. Select **Voice mail** and press **OK**.
4. Select **Options** and press **OK**.
5. Select **Call voice mail** and press **OK** to call the voice mailbox.

Tip:

Press and hold shortcut button **1** to call your voice mail.

If activated reminder in the Messages settings, a reminder signal will be heard after 10 minutes if not listening to the voice mail message.

Speed dial

A, **B**, and the numerical keys **0** and **2–9** can be used for speed dialling.



Adding speed dial numbers

1. Press **Menu**, scroll to  and press **OK**.
2. Select **Calls** and press **OK**.
3. Select **Speed dial** and press **OK**.
4. Select **A** and press **Add**.
5. Select an entry from the phonebook and press **OK**.
6. Repeat to add speed dial entries for buttons **B**, **0**, **2–9**.

To change contact, select an existing entry and press **Options**, then select **Edit** or **Delete** and press **OK**.



To speed dial an entry from standby, press and hold corresponding button.

You can edit the contact information for the dedicated speed dial buttons **A** and **B**.

1. Press corresponding button. Use / to highlight the name or the number, then press **Edit**.
2. Press **OK** to confirm. Delete with **Clear**.

Top 10

 Set the entry as one of the first 10 contacts listed in the phonebook.

1. Press **Menu**, scroll to  and press **OK**.
2. Select **Calls** and press **OK**.
3. Select **Top 10** and press **OK**.
4. Select one of the empty entries and press **Add**.
5. Use / to scroll through the phonebook, or quick search by pressing the key corresponding to the first letter of the entry.
6. Press **OK** to save the selected entry, or press **Back** to discard changes.

To delete a Top 10 entry, select the entry in the Top 10 list and press **Options**, then **Delete**.

Tip:

You can also add  entry from the phonebook. Select the contact and press **Options**, then **Top 10** and press **OK**.

Call time

During a call, the duration of the call is shown. You can check the duration of your calls.

1. Press **Menu**, scroll to  and press **OK**.
2. Select **Calls** and press **OK**.
3. Select **Call time** and press **OK**.
4. Select one of the following options and press **OK**.

Last call	Show the elapsed time of the most recent call.
Outgoing calls	Show the elapsed time of all dialled calls.
Received calls	Show the elapsed time of all received calls.
Reset all	Press Yes to reset the timer, or No to discard changes.

Any key

Select **Any key** and press **OK**, select **On** and press **OK** to be able to answer incoming calls by pressing any button (exemption .

Call setup

Depending on network support and subscription. Contact your service provider for more information.

Caller ID

Display or hide your phone number on the recipient's phone when you call.

1. Press **Menu**, scroll to  and press **OK**.
2. Select **Calls** and press **OK**.
3. Select **Call setup** and press **OK**.
4. Select **Caller ID** and press **OK**.
5. Select one of the following options and press **OK**.

Set by network	Use default setting by the network.
Hide ID	Never show your number.
Send ID	Always show your number.

Call waiting

You can handle more than one call at a time. An alert tone will be heard if there is an incoming call while talking. To put the current call on hold and answer the incoming call, press **Options**, select **Answer** and then **OK**.

1. Press **Menu**, scroll to  and press **OK**.
2. Select **Calls** and press **OK**.
3. Select **Call setup** and press **OK**.
4. Select **Call waiting** and press **OK**.
5. Select one of the following options and press **OK**.

Activate	Enables call waiting.
Deactivate	Disables call waiting.
Query status	Displays if call waiting is active or not.

Call divert

You can divert calls to an answering service, or to another phone number. Set up which calls should be diverted. Select a condition and press **OK**, then select **Activate**, **Deactivate** or **Query status** (see [Call waiting, p.33](#)) for each.

1. Press **Menu**, scroll to  and press **OK**.
2. Select **Calls** and press **OK**.
3. Select **Call setup** and press **OK**.
4. Select **Call divert** and press **OK**.
5. Select one of the following options and press **OK**.

Voice calls	Diverts all voice calls.
Unreachable	Diverts incoming calls if the phone is turned off or out of range.
No reply	Diverts incoming calls if unanswered.
If busy	Diverts incoming calls if the line is busy.
Cancel diverts	Do not divert calls.

Call barring

Your phone can be restricted to disallow certain types of calls.

Note!

A password is needed to apply Call barring. Contact your service provider to get the password.

1. Press **Menu**, scroll to  and press **OK**.
2. Select **Calls** and press **OK**.
3. Select **Call setup** and press **OK**.
4. Select **Call barring** and press **OK**.
5. Select one of the following options and press **OK**.

Outgoing calls	Press OK then select:
All calls	User can answer incoming calls but not dial out.
Internat.calls	User can not call international numbers.
Int. except home	User can not call international numbers except to the country associated with the SIM card.
Incoming calls	Press OK then select:
All calls	User can dial out but not receive incoming calls.

When roaming	User can not receive incoming calls while roaming (operating in other networks).
Cancel all	Cancel all call barring (password needed).

Messages

1. Press **Menu**, scroll to  and press **OK**.
2. Select **Messages** and press **OK**.
3. Select one of the following options and press **OK**.

Predictive text

Select **On** and press **OK** to enable Predictive text/eZiType™, see [Entering text !\[\]\(d66ff64371a51729ac8c1cdaa685ba6f_img.jpg\) , p. 6](#).

Write speed

You can change the speed at which keypad characters repeat (before the cursor moves onto the next character).

Select **Fast**, **Normal** or **Slow** and press **OK**.

SMS settings

Memory status

Displays the percentage of memory space used on the SIM card and in the phone memory. Phone memory can store up to 200 messages.

Storage

1. Select **SIM** (default) to store messages on the SIM card, or **Phone** to store messages in the phone memory.
2. Press **OK**.

Profile set

This number is needed to use the message function. The number to your service centre is supplied by your service provider and is usually set on the SIM card. If the service centre number is saved on the SIM card it is shown. If not, you can enter the number yourself. Contact your service provider for more information.

1. Press **Edit** and enter the service centre number. Press **Clear** to delete.
2. Press **OK** to save the new number.

Cell information

You can receive messages on various topics from your service provider, such as weather or traffic conditions in a particular region. For available channels and relevant channel settings, contact your service provider. Cell broadcast messages cannot be received when the device is roaming.

Select **Cell information** and press **OK** for the following settings:

Function on/off	To turn information On or Off .
Read messages	Press OK to read the message.
Languages	Select language On/Off and press Done .
Channel settings	Select from which channels you want to receive/subscribe messages. Use the options Subscribe , Cancel subscription , Add , Edit and Delete to define your channels.

MMS settings

Memory status

Displays the percentage of memory space used in the phone memory.

MMS profile

These settings are needed to use the MMS function. The settings for MMS is supplied by your service provider and can be sent to you automatically.

1. Select **MMS profile** and press **OK**.
2. Select your service provider and press **Options**.
3. Select **Activate** and press **OK**.

If your service provider is not in the list, do the following:

1. Select **MMS profile** and press **OK**.
2. Select **Add** and press **OK** for the following settings:
Enter the settings for your service provider. The correct settings can be obtained from the service provider.

Account name	Add account name.
APN	Add APN (Access Point Name).
User name	Add user name.
Password	Add password.
Homepage	Add homepage.
Connection type	Use the side buttons +/- to select connection type HTTP or WAP .
Proxy address	Add proxy address.
Proxy port	Add proxy port.
User name	Add proxy user name.
Password	Add proxy password.

3. Press **OK** and press **Yes** to save or **No** to exit without saving.
4. Select your new profile and press **Options**.
5. Select **Activate** and press **OK**.

You can also activate/modify a MMS profile by selecting one and press **Options** to **Activate/Edit/Delete** the account.

Note!

Some service provider's require you to send an MMS message before you will be able to receive one. Send a MMS with text only to activate the service. Some service provider's require that you contact them before enabling MMS for your account. Contact your service provider's Customer Services. Press  during set up to exit without saving.

Reminder

The SMS reminder alerts you once if you haven't checked your text message or listened to your voice mail within 10 minutes from receipt. If notification envelope is removed by pressing , no reminder will be heard.

Select **Reminder** and press **On/Off** to enable/disable.

Vibration

The SMS vibration alert is several short vibrations that continues for either **Short** (4 seconds) or **Long** (12 seconds).

Note!

If Alert type is set to Ring only the phone will not vibrate.

Delivery report

You can select if you want the phone to notify you when your SMS has reached the receiver.

Select **Delivery report** and press **OK**. Select **On** or **Off** to enable/disable. Press **OK** to save.

Note!

*If you choose **Delivery report=On**, some operators will charge you for that message.*

Delete

Select **Inbox** to delete all messages in Inbox. Press **Yes** confirm or **No** to discard changes.

Select **Outbox** to delete all messages in Outbox. Press **Yes** confirm or **No** to discard changes.

Select **Sent** to delete all messages in Sent. Press **Yes** confirm or **No** to discard changes.

Select **Delete all** to delete all messages at the same time. Press **Yes** confirm or **No** to discard changes.

Camera

1. Press **Menu**, scroll to  and press **OK**.
2. Select **Camera** and press **OK**.
3. Select one of the following options and press **OK**.

EV information

EV/Light sensitivity can be adjusted by pushing volume keys up & down when in camera mode.

Flash

Select one of the following options **Auto**, **Off**, **On** or **Red-eye reduction**.

Image size

Select one of the following options **Wallpaper** (lowest quality), **1 MP**, **2 MP** or **3 MP** (highest quality).

Note!

With higher quality (more megapixels), less pictures can be stored in memory.

Shutter sound

Select one of the following options **Off**, **Low** or **High**.

Assistance +

Settings for the Assistance button function.

1. Press **Menu**, scroll to  and press **OK**.
2. Select **Assistance** and press **OK** for the following settings:

Activation

Select one of the following options and press **OK**.

On Normal	To activate, press and hold button for approximately 3 seconds, or press 2 times within 1 second.
On (3)	To activate, press button 3 times within 1 second.
Off	Assistance button disabled.

Number list

The list of numbers that will be called when the Assistance button is pressed.

1. Select **Empty** and press **Add**.
2. Select **Phonebook** to add a contact from the phonebook. Alternatively, press **Manual**. See [Phonebook, p.12](#) on how to add names/numbers.
3. Press **OK**.

Repeat until you have 5 contacts (maximum).

To edit or delete an existing entry, select it and press **Options**, then select **Edit** or **Delete** and press **OK**.

SMS

The message to be sent to the contacts in numbers list when the Assistance button is pressed.

Activation

Select one of the following options and press **OK**.

On	The phone sends a text message before dialling.
Off	The phone dials without sending a message first.

Message

Press **Edit** and enter the message and then press **OK** to confirm.

Note!

*You **must** write a message if you activate the SMS function.*

Confirm with "0"

Select one of the following options and press **OK**.

Off	The phone will dial the first number on the list. If the call is not answered within 25 seconds, the next number is dialled. Dialling is repeated 3 times or until the call is answered, or until  is pressed.
On	The function will work as above AND: If the receiver doesn't press 0 within 60 seconds the call will be disconnected and the next number in sequence will be called. If the receiver presses 0 within 60 seconds, the call is confirmed and no further call attempts will be made (assistance sequence interrupted).

Signal type

Adjustment of the signal type for notification of the assistance sequence.

Select one of the following options and press **OK**.

High	Loud signals (default).
Low	One low signal.
Silent	No sound indication, like a normal call.

Alarm info

Please read this important safety information before enabling the assistance function:

Be careful about including numbers with automatic answering in the call list, as the alarm sequence stops once the call is answered.

Note!

*This information is not applicable if **Confirm with "0"** is set to **On**.*

Bluetooth®

IMPORTANT!

When you are not using Bluetooth connectivity, select **Function on/off / Off** or **Visibility / Off**. Do not pair with an unknown device.

You can connect wireless to other Bluetooth compatible devices such as headsets.

1. Press **Menu**, scroll to  and press **OK**.
2. Select **Bluetooth** and press **OK** for the following settings:

Function on/off

Select **On/Off** and press **OK** to enable/disable Bluetooth.

Visibility

Select **On/Off** to make your phone visible/invisible to other devices.

Note!

*To prevent other devices from finding your device, select **Off**. Even if you select **Off**, paired devices can still detect your device.*

Device name

Enter the name your phone should appear with for other Bluetooth devices and press **OK**.

Search device

Search for available Bluetooth audio devices. If Bluetooth is not enabled you can enable it now by pressing **Yes**.

1. Select from the list of devices and press **Bond** to connect.

- When connecting to another Bluetooth device you need a shared password. Enter the password and press **OK**.

My device

Lists saved devices and enables you to add new devices. Select device from the list and press **Options**.

Connect/Disconnect	Connect/disconnect selected device. Select required profile, usually a headset.
Set default	Select the connected device as default.
Rename	Change the name of the device.
Delete	Delete the device from the list.
Delete all	Delete all devices from the list.

Audio path

Select one of the following options and press **OK**.

Phone	Incoming calls are answered with the phone.
Forward BT	Incoming calls are forwarded to Bluetooth device.

Security

- Press **Menu**, scroll to  and press **OK**.
- Select **Security** and press **OK**.

SIM lock

The SIM card is protected with a PIN code (Personal Identification Number). The phone can be set to ask for the PIN code on startup.

Select one of the following options and press **OK**.

On	PIN code activated, you need to enter the PIN code every time the phone is started.
Off	PIN code deactivated. Warning, if SIM card is lost/stolen it is unprotected.
Automatic	You do not need to enter the PIN code when the phone is started, the phone remembers it automatically. If SIM card is moved to another phone (lost/stolen), the PIN code needs to be entered to unlock.

Note!

You need to input the current PIN code to disable/enable SIM lock.

Phone lock



Select **On/Off** and press **OK** to enable/disable.

Note!

You need to input the current Phone code to disable/enable Phone lock.
The default Phone code is **1234**.

Keypad lock

Select one of the following options and press **OK**.

Auto keylock	Select the time delay for automatic keypad locking. Press OK to confirm.
Unlock mode	Select Single key to unlock the keypad with  or Dual key to lock/unlock with right selection button (Name/Unlock) and  . Press OK to confirm.

Auto keylock

Select **On/Off** and press **OK**.

Remote configuration 

Allow persons that you trust, usually a family member or friend, to send information to your Doro PhoneEasy® 520X. You can receive phonebook contacts and contacts for speed dial keys, calendar tasks and settings for the Assistance button. When activated, you don't have to do anything, it's the other person that sends information to you.

Select **Remote config** and press **OK** for the following settings:

Activation

Select **On** to activate remote configuration and press **OK**.

On	Remote configuration enabled.
Off	Remote configuration disabled.

Number list

You need to add the name and number of the people who are allowed to send information from their phone to your Doro PhoneEasy® 520X.

1. Select **Number list** and press **OK**.
2. Select **Empty** and press **Add**.
3. Select **Phonebook** to add a contact from the Phonebook. Alternatively, press **Manual**.
4. Press .
5. Enter the number and press **OK**.

Repeat until you have 5 contacts (maximum).

To edit or delete an existing entry, select it and press **Options**, then select **View**, **Edit** or **Delete** and press **OK**.

Fixed dial (FDN)

You can limit calls to certain numbers saved on the SIM card. The list of allowed numbers is protected by your PIN2-code.

Mode	Select On/Off and press OK . Enter PIN2. Press OK to confirm.
Fixed numbers	Press Add to enter the first allowed number. Alternatively, select an entry and press Options for the following settings: Add , Edit or Delete and press OK . Enter PIN2. Press OK to confirm.

Note!

You can save parts of phone numbers. For example, if you save 01234, allows calls to all numbers starting with 01234. It is possible to place an SOS call by entering the main local emergency number followed by  even when fixed dial is activated. When fixed dial is activated you are not allowed to view or manage any phone numbers saved on the SIM card. You are not able to send any SMS either.

Passwords (change your passwords)

To change the **PIN**, **PIN2** or the **Phone code** passwords:

1. Enter the current code and confirm with **OK**.
2. Enter a new code and confirm with **OK**.
3. Enter the new code again and confirm with **OK**.

Reset settings

If you select **Reset settings**, the changes that you have made to the phone settings will be reset to default settings. Input the phone password and press **OK** to reset.

Reset all

If you select **Reset all**, your phone's settings and content, such as contacts, number lists and messages, will be deleted in phone memory (SIM memory is not affected). Input the phone password and press **OK** to reset.

Note!

*The default Phone code is **1234**.*

File manager

Manage the contents and properties of files. You can open, delete, move, copy and rename files.



Supported image format: BMP/GIF/JPG/PNG. Photos taken with the built in camera are saved as JPG.

Supported audio format: WAV/AMR/MIDI/MP3/AAC/AAC+. Recordings made with the built in sound recorder are saved as AMR.

Supported video format: MP4/3GPP. Only playback is possible.

1. Press **Menu**, scroll to  and press **OK**.
2. Select **File manager**, then press **OK**.
3. Select **Phone/Memory card** and press **Open**.
4. Select a folder, eg **Photos** and press **Open**.
5. Select a file and press **Options** for the following options:

Play (audio/video/music)

Play file. Use  to **Play**, use  to **Stop** playback. Press **Back** when done.

View (photos/images)

Single view. Press **Back** when done.

Send

Select an option, then press **OK**:

Send by MMS	Send by MMS. Press OK to create a message, see Creating and sending MMS, p.16 .
Send by Bluetooth	Send to other Bluetooth devices, see Bluetooth®, p.41 .

Details

View detailed information about the file, e.g. date, size, copyright-protection.

Use

Select an option from the list, then press **OK**.

Wallpaper	Save as display background. Press OK .
Phonebook picture	Send to a phonebook contact. Press OK .

Rename

Rename the file. Delete with **Clear** and press **Done** to confirm.

Delete

Press **OK** to delete selected file. Press **Yes** to confirm or **No** to return.

Delete all

Press **OK** to delete all files in selected folder. Press **Yes** to confirm or **No** to return.

Sort by

Select if you want to sort your files by **Name** or **Time**.

Copy/Move

To copy or move a file to another folder:

1. Select **Copy/Move** and press **OK**.
2. Select **Phone/Memory card** and press **Options**.
3. Select **Open** and press **OK**.

4. Select a folder, eg **Photos** and press **Options**.
5. Select **Paste** and press **OK**.

Additional functions

Alarm

1. Press **Menu**, scroll to  and press **OK**.
2. Select **On** and press **OK**.
3. Enter the alarm time using the keypad, then press **OK**.
4. For a single occurrence, select **Single** and press **OK**.
5. For a repeated alarm, select **Repeated** and press **OK**. Scroll through the list of weekdays and press **On/Off** to enable/disable the alarm for each weekday, then press **Done**.
6. To edit an alarm, press **Edit**, then press **OK**.
7. To stop the alarm, press **Off**. The alarm is now deleted.

Note!

*The alarm will work even when the phone is switched off. Do not press **Yes** to power on if wireless phone use is prohibited or when it may cause interference or danger.*

*When the alarm goes off a signal will sound. Press **Stop** to turn off the alarm or press **Snooze** to repeat the alarm after 9 minutes.*

Organizer



1. Press **Menu**, scroll to  and press **OK**.
2. Select one of the following options and press **OK**.

Calendar

View

Show tasks for the selected date.

Add task

1. Enter date for the task, then press .
2. Enter time for the task, then press .
3. Enter subject.
4. Press **OK**.

Jump to date

Enter the date and press **OK**.

View all

Select a task and press **Options** for the following options:

Edit	Edit selected task.
Delete	Delete selected task.
Delete all	Delete all tasks.

Note!

*The calendar will work even when the phone is switched off. Do not press **Yes** to power on if wireless phone use is prohibited or when it may cause interference or danger.*

**Daily reminder**

1. Enter time for the task, then press .
2. Enter subject.
3. Press **OK** to save the task.

Note!

*Works even when the phone is switched off. Do not press **Yes** to power on if wireless phone use is prohibited or when it may cause interference or danger.*

*When the alarm goes off a signal will sound. Press **Stop** to turn off the alarm or press **Snooze** to repeat the alarm after 9 minutes.*

**Notes**

Write down notes as you would on a note pad.

1. Select **Add** to enter your note using the keypad.
2. Press **Save** to save the note.

Select a note and press **Options** for the following options:

Add	Add new note.
Edit	Edit selected note.
Delete	Delete selected note.
Delete all	Delete all notes.

Calculator





The calculator can perform basic mathematical operations.

1. Press **Menu**, scroll to  and press **OK**.
2. Enter the first number. Use **#** to enter decimal points.
3. Use the arrow buttons to select an operation (+, -, x, ÷) and press **OK**.
4. Enter the next number and press **OK**.
5. Repeat steps 2–4 as necessary.
Select **=** and press **OK** to calculate the result.



FM radio

The FM radio has a frequency range from 87.5 to 108.0 MHz and 9 preset channels.





Turning the radio on

1. Connect the headset to the headset socket .
2. Press **Menu**, scroll to  and press **OK**. The radio is turned on. The tuned frequency is displayed. Select channel using  or . Use the side keys **+/-** to adjust the volume.
3. Press  to return to standby mode. The radio will continue to play.

Loudspeaker

1. Connect the headset to the headset socket .
2. Press **Menu**, scroll to  and press **OK**.
3. Select **Options** then Loudspeaker and press **OK**.
4. Select **On** to activate the loudspeakers. Use the side buttons **+/-** to adjust the sound volume.
5. To turn off, select **Off**.

Save frequency

1. Press **Menu**, scroll to  and press **OK**.
2. Select channel using  or .
3. When a station has been found, select **Options**.
4. Select **Save frequency** and press **OK**.
5. Enter a name for the new channel, see [Entering text](#) , p. 6 .
6. Press **Save**.

Switch off

1. Press **Menu**, scroll to  and press **OK**.
2. Press **Options**, then press **Switch off**.

Tip:

Disconnecting the headset will also turn off the radio.

Channel list (editing the channel list)

1. Press **Menu**, scroll to  and press **OK**.
2. Select **Options**.
3. Select **Channel list** and press **OK**.
4. Select the channel you wish to edit and press **Options** or **Add**.
5. Select one of the following options and press **OK**.





Play	Play the selected channel.
Delete	Delete the channel. Press Yes to confirm or No to return to the channel list.
Edit	Edit the channel name, then press  to edit the frequency, use # to enter the decimal point. Press Save .

Selecting channels

Press keys **1-9** to quick-select a preset channel while the radio is playing.

Manual input (changing search mode)

1. Press **Menu**, scroll to  and press **OK**.
2. Select **Options**.
3. Select **Manual input** and press **OK**.
4. Select one of the following options and press **OK**.

Fine tune	Manual tuning with  or  .
Auto search	Automatic station search with  or  .

Auto save



Note!

This will overwrite all previously saved channels!

1. Press **Menu**, scroll to  and press **OK**.
2. Select **Options**.
3. Select **Auto save** and press **OK** to automatically install available radio stations in channels **1-9**.

Status

Scroll the status list to get further information about the icons shown on top of your display. Icons shown on the display varies depending on your phone status.

1. Press **Menu**, scroll to  and press **OK**.
2. Use  or  to scroll the list.
3. Press **Back** to return to standby mode.

Instructions for the REMOTE USER

Sending remote control commands by text message.

Activation must be set to **On** and the remote user must be entered in **Number list** on the Doro PhoneEasy® 520X.

Menu →  → **Security** → **Remote config**.

All contacts sent to Doro PhoneEasy® 520X by remote configuration are stored in the Phone (even if storage is set to SIM).

3 phone numbers for each contact  Mobile,  Home or  Office.

Note!

*SMS format must be ***#Command#**, otherwise the SMS cannot be identified as a remote control command.*

Parameters are the content you want to send and you must use # sign to separate two parameters. In tables P = Parameters.

Setting a contact in the phonebook

Command	P 1	P 2	P 3	P 4
phonebook	name max. length=30	mobile max. length=40	home	office

Example:

You want to send Jeff Jackson's mobile number, home number and his office number to Doro PhoneEasy® 520X. The mobile number is: 0700-393939. Home number: 046-280 50 11. Office number: 046-280 50 83.

*#phonebook#Jeff Jackson#0700393939#0462805011#0462805083#

The number will be saved in the 520X Phonebook as:



Jeff Jackson



0700393939



0462805011



0462805083

Note!

Only use numerals for parameters 2, 3 and 4. If you use letters in these parameters it will be stored as empty/blank in the Phonebook. Contacts already saved in the Phonebook, will not be replaced. They will be duplicated. This is to avoid unintentional removal of contacts from the Phonebook.

Tip:

When storing international numbers, always use + before the country code for best operation. Enter the phone number including the area code.

Setting the assistance function

Command	P 1	P 2	P 3	P 4
alert	a activation	0/1/2 0=Off 1=On Normal 2=On (3)		
alert	n number	1-5 location in Number list	Name max. length=30	number max. length=40

alert	m message	0/1 0=Off 1=On	Text max. length=70	
alert	c confirm with "0"	0/1 0=Off 1=On		
alert	s signal type	0/1/2 0=High 1=Low 2=Silent		

Example:

You want to activate the assistance function.

*#alert#a#1#

You want Jeff Jackson to be stored in Number list in position one (1) with phone number: 0700-393939.

*#alert#n#1#Jeff Jackson#0700393939#

You want the SMS message to be sent out when the **Assistance** button is pressed. Example of content in text message: This is an assistance message. Please take appropriate actions.

*#alert#m#1#This is an assistance message. Please take appropriate actions.#

You want to turn on the function Confirm with "0".

*#alert#c#1#

You want to set the Signal type to low.

*#alert#s#1#

Tip:

Remember to write down the positions you send. This way it is easier for you to later send changes.

Setting the one touch memories

Command	P 1	P 2	P 3
memorykey	a A key	Name max length = 30	number max length = 40
memorykey	b B key	Name max length = 30	number max length = 40
memorykey	c C key	Name max length = 30	number max length = 40

Example:

You want to set Jeff Jackson's mobile number in memory key **A** in Doro PhoneEasy® 520X.

Martha Thomson in memory key **B** and Steve Lewis in memory key **C**.

```
*#memorykey#a#Jeff Jackson#0700393939#
```

```
*#memorykey#b#Martha Thomson#0768991014#
```

```
*#memorykey#c#Steve Lewis#0709441819#
```

Add task to calendar

Command	P 1	P 2	P 3
task	yyyymmdd Date	hhmm Time	note description of task. max. length = 35

Example 1:

You want to send a new calendar task to Doro PhoneEasy® 520X. It is for a dentist appointment in December 1, 2010 at 10:30.

```
*#task#20101201#1030#dentist appointment#
```

Troubleshooting

Phone cannot be switched on

Battery charge low	Connect the power adapter and charge the battery for 3 hours. Full battery capacity is reached after the battery has been charged 3–4 times.
Battery incorrectly installed	Check the installation of the battery.

Failure to charge the battery

Battery or charger damaged	Check the battery and charger.
Battery should only be charged in temperatures between 0 °C and 40 °C	Improve the charging environment.
Charger incorrectly connected to phone or power socket	Check the charger connections.

Standby time decreases

Battery charge capacity too low	Install a new battery.
Too far from base station, phone is constantly searching for signal	Searching the network consumes battery power. Find a place with a stronger signal, or temporarily turn off the phone.

Failure to place or receive calls

Call barring activated	Deactivate call barring. If this does not solve the problem, contact your service provider.
-------------------------------	---

PIN code not accepted

Wrong PIN code entered too many times	Enter the PUK code to change the PIN code, or contact your service provider.
--	--

SIM card error

SIM card damaged	Check the condition of the SIM card. If it is damaged, contact your service provider.
SIM card incorrectly installed	Check the installation of the SIM card. Remove the card and reinstall it.
SIM card dirty or damp	Wipe the contact surfaces of the SIM card with a clean cloth.

Failure to connect to network

SIM card invalid	Contact your service provider.
No coverage of GSM service	Contact your service provider.

Weak signal

Too far from base station	Try again from another location.
Network congestion	Try calling at a later time.

Echo or noise

Regional problem from bad network relay	Hang up and redial. This may switch to another network relay.
--	---

Failure to add a contact

Phonebook memory full	Delete contacts to free up memory.
------------------------------	------------------------------------

Failure to set a function

Function not supported or subscribed from network	Contact your service provider.
--	--------------------------------

Safety instructions** CAUTION**

The unit and the accessories can contain small parts. Keep all of the equipment out of the reach of small children.
The mains adapter is the disconnect device between the product and mains power. The mains socket outlet must be close to the equipment and easily accessible.

Network services and costs

Your device is approved for use on the WCDMA 900/2100 MHz, GSM 900/1800/1900 MHz networks. To use the device, you need a subscription with a service provider.

Using network services may result in traffic costs. Some product features require support from the network, and you may need to subscribe to them.

Operating environment

Follow the rules and laws that apply wherever you are, and always turn off the unit whenever its use is prohibited or can cause interference or hazards. Only use the unit in its normal user position.

This unit complies with guidelines for radiation when it is used either in a normal position against your ear, or when it is at least 1.5 cm from your body. If the unit is carried close to your body in a case, belt holder or other holder, these holders should not contain any metal, and the product should be placed at the distance from your body specified above. Make sure that the distance instructions above are followed until the transfer is complete.

Parts of the unit are magnetic. The unit can attract metal objects. Do not keep credit cards or other magnetic media near the unit. There is a risk that information stored on them can be erased.

Medical units

The use of equipment that transmits radio signals, for example, mobile phones, can interfere with insufficiently protected medical equipment. Consult a doctor or the manufacturer of the equipment to determine if it has adequate protection against external radio signals, or if you have any questions. If notices have been put up at health care facilities instructing you to turn off the unit while you are there, you should comply. Hospitals and other health care facilities sometimes use equipment that can be sensitive to external radio signals.

Pacemakers

The Health Industry Manufacturers Association recommends that a minimum separation of 15 cm be maintained between a handheld wireless phone and a pacemaker to avoid potential interference with the pacemaker. Persons with pacemakers:

- Should always keep the phone more than 15 cm from their pacemaker when the phone is turned on.
- Should not carry the phone in a breast pocket.
- Should use the ear opposite the pacemaker to minimize the potential for interference.

If you have any reason to suspect that interference is taking place, turn the phone off immediately.

Areas with explosion risk

Always turn off the unit when you are in an area where there is a risk of explosion. Follow all signs and instructions. There is a risk of explosion in places that include areas where you are normally requested to turn off your car engine. In these areas, sparks can cause explosion or fire which can lead to personal injury or even death.

Turn off the unit at filling stations, and any other place that has fuel pumps and auto repair facilities.

Follow the restrictions that apply to the use of radio equipment near places where fuel is stored and sold, chemical factories and places where blasting is in progress.

Areas with risk for explosion are often – but not always – clearly marked. This also applies to below decks on ships; the transport or storage of chemicals; vehicles that use liquid fuel (such as propane or butane); areas where the air contains chemicals or particles, such as grain, dust or metal powder.

Li-ion battery

This product contains a Li-ion battery. There is a risk of fire and burns if the battery pack is handled improperly.



WARNING

Danger of explosion if battery is incorrectly replaced. To reduce risk of fire or burns, do not disassemble, crush, puncture, short external contacts, expose to temperature above 60° C (140° F), or dispose of in fire or water. Recycle or dispose of used batteries according to the local regulations or reference guide supplied with your product.

Protect your hearing

This device has been tested to comply with the Sound Pressure Level requirement laid down in the applicable EN 50332-1 and/or EN 50332-2 standards.

**WARNING**

Excessive exposure to loud sounds can cause hearing damage. Exposure to loud sounds while driving may distract your attention and cause an accident. Listen to a headset at a moderate level, and do not hold the device near your ear when the loudspeaker is in use.

Note!

For France, mobile headphones or earphones for this device have been tested to comply with the Sound Pressure requirement laid down in the applicable NF EN 50332-1:2000 and/or NF EN 50332-2:2003 standards as required by French Article L. 5232-1.

A pleine puissance, l'écoute prolongée du baladeur peut endommager l'oreille de l'utilisateur.

Emergency calls

IMPORTANT!

Mobile phones use radio signals, the mobile phone network, the terrestrial network and user-programmed functions. This means that connection cannot be guaranteed in all circumstances. Therefore, never rely only on a mobile phone for very important calls such as medical emergencies.

Vehicles

Radio signals can affect electronic systems in motor vehicles (for example, electronic fuel injection, ABS brakes, automatic cruise control, air bag systems) that have been incorrectly installed or are inadequately protected. Contact the manufacturer or its representative for more information about your vehicle or any additional equipment.

Do not keep or transport flammable liquids, gases or explosives together with the unit or its accessories. For vehicles equipped with air bags: Remember that air bags fill with air with considerable force.

Do not place objects, including fixed or portable radio equipment in the area above the airbag or the area where it might expand. Serious injuries may be caused if the mobile phone equipment is incorrectly installed and the airbag fills with air.

It is prohibited to use the unit in flight. Turn off the unit before you board a plane. Using wireless telecom units inside a plane can pose risks to air safety and interfere with telecommunications. It may also be illegal.

Care and maintenance

Your unit is a technically advanced product and should be treated with the greatest care. Negligence may void the warranty.

- Protect the unit from moisture. Rain/snowfall, moisture and all types of liquid can contain substances that corrode the electronic circuits. If the unit gets wet, you should remove the battery and allow the unit to dry completely before you replace it.
- Do not use or keep the unit in dusty, dirty environments. The unit's moving parts and electronic components can be damaged.
- Do not keep the unit in warm places. High temperatures can reduce the lifespan for electronic equipment, damage batteries and distort or melt certain plastics.
- Do not keep the unit in cold places. When the unit warms up to normal temperature, condensation can form on the inside which can damage the electronic circuits.
- Do not try to open the unit in any other way than that which is indicated here.
- Do not drop the unit. Do not knock or shake it either. If it is treated roughly the circuits and precision mechanics can be broken.
- Do not use strong chemicals to clean the unit.

The advice applies to the unit, battery, mains adapter and other accessories. If the phone is not working as it should, please contact the place of purchase for service. Don't forget the receipt or a copy of the invoice.

Warranty

This product is guaranteed for a period of 12 months from the date of purchase. In the unlikely event of a fault occurring during this period, please contact the place of purchase. Proof of purchase is required for any service or support needed during the guarantee period.

This guarantee will not apply to a fault caused by an accident or a similar incident or damage, liquid ingress, negligence, abnormal usage, non-maintenance or any other circumstances on the user's part. Furthermore, this guarantee will not apply to any fault caused by a thunderstorm or any other voltage fluctuations. As a matter of precaution, we recommend disconnecting the charger during a thunderstorm.

Batteries are consumables and are not included in any guarantee.

This guarantee does not apply if batteries other than DORO original batteries are used.

Specifications

Network:	WCDMA 900/2100 MHz, GSM 900/1800/1900 MHz
Dimensions:	118 mm x 53 mm x 13 mm

Weight:	93 g (including battery)
Battery:	3.7 V / 800 mAh Li-ion battery

Bluetooth® is a registered trademark of Bluetooth SIG, inc.

eZiType™ is a trademark of Zi Corporation.

vCard is a trademark of the Internet Mail Consortium.

Hearing aid

This device should work with most hearing aid equipment in the market. However, full compatibility with all equipment can not be promised.

Specific Absorption Rate (SAR)

This device meets applicable international safety requirements for exposure to radio waves. Doro PhoneEasy® 520X measures 0.721 W/kg measured over 10 g tissue.

The maximum limit according to WHO is 2.0 W/kg measured over 10 g tissue.

Declaration of Conformity

Doro hereby declares that Doro PhoneEasy® 520X conforms to the essential requirements and other relevant regulations contained in the Directives 1999/5/EC (R&TTE) and 2002/95/EC (RoHS). A copy of the Declaration of Conformity is available at www.doro.com/dofc

PhoneEasy 520X (2021)

English

Version 1.2

© 2012 Doro AB. All rights reserved.

www.doro.com

CE 0700

REV 6285 — STR 20121015