

# Yealink

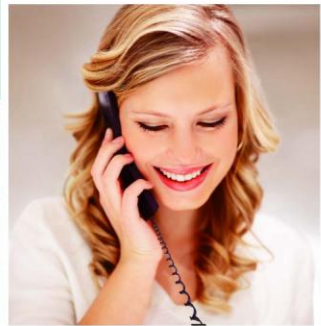

**HD** 



**SIP-T28P**

# Enterprise IP Phone

User Guide (V61.0)

# Copyright

**Copyright © 2011 YEALINK NETWORK TECHNOLOGY CO., LTD.**

Copyright © 2011 Yealink Network Technology CO., LTD. All rights reserved. No parts of this publication may be reproduced or transmitted in any form or by any means, electronic or mechanical, photocopying, recording, or otherwise, for any purpose, without the express written permission of Yealink Network Technology CO., LTD. Under the law, reproducing includes translating into another language or format.

When this publication is made available on media, Yealink Network Technology CO., LTD. gives its consent to downloading and printing copies of the content provided in this file only for private use and not for redistribution. No parts of this publication may be subject to alteration, modification or commercial use. Yealink Network Technology CO., LTD. will not be liable for any damages arising from use of an illegally modified or altered publication.

## Warranty

THE SPECIFICATIONS AND INFORMATION REGARDING THE PRODUCTS IN THIS GUIDE ARE SUBJECT TO CHANGE WITHOUT NOTICE. ALL STATEMENTS, INFORMATION, AND RECOMMENDATIONS IN THIS GUIDE ARE BELIEVED TO BE ACCURATE BUT ARE PRESENTED WITHOUT WARRANTY OF ANY KIND, EXPRESS OR IMPLIED. USERS MUST TAKE FULL RESPONSIBILITY FOR THEIR APPLICATION OF PRODUCTS.

YEALINK NETWORK TECHNOLOGY CO., LTD. MAKES NO WARRANTY OF ANY KIND WITH REGARD TO THIS GUIDE, INCLUDING, BUT NOT LIMITED TO, THE IMPLIED WARRANTIES OF MERCHANTABILITY AND FITNESS FOR A PARTICULAR PURPOSE. Yealink Network Technology CO., LTD. shall not be liable for errors contained herein nor for incidental or consequential damages in connection with the furnishing, performance, or use of this guide.

## Declaration of Conformity



Hereby, Yealink Network Technology CO., LTD. declares that this phone is in conformity with the essential requirements and other relevant provisions of the CE, FCC.

## CE Mark Warning

This device is marked with the CE mark in compliance with EC Directives 2006/95/EC and 2004/108/EC.

## Part 15 FCC Rules

This device is compliant with Part 15 of the FCC Rules. Operation is subject to the following two conditions:

1. This device may not cause harmful interference, and
2. This device must accept any interferences received, including interference that may cause undesired operation.

## Class B Digital Device or Peripheral

Note: This device is tested and complies with the limits for a Class B digital device, pursuant to Part 15 of the FCC Rules. These limits are designed to provide reasonable protection against harmful interference in a residential installation. This equipment generates, uses, and can radiate radio frequency energy and, if not installed and used in accordance with the instructions, may cause harmful interference to radio communications. However, there is no guarantee that interference will not occur in a particular installation. If this equipment does cause harmful interference to radio or television reception, which can be determined by turning the equipment off and on, the user is encouraged to try to correct the interference by one or more of the following measures:

1. Reorient or relocate the receiving antenna.
2. Increase the separation between the equipment and receiver.
3. Connect the equipment into an outlet on a circuit different from that to which the receiver is connected.
4. Consult the dealer or an experienced radio/TV technician for help.

## WEEE Warning



To avoid the potential effects on the environment and human health as a result of the presence of hazardous substances in electrical and electronic equipment, end users of electrical and electronic equipment should understand the meaning of the crossed-out wheeled bin symbol. Do not dispose of WEEE as unsorted municipal waste and have to collect such WEEE separately.



## About This Guide

Thank you for choosing the SIP-T28P IP phone, an exquisitely designed SIP IP phone. This unit provides business telephony features such as Call Hold, Call Transfer, Busy Lamp Field, Shared Line, Hot Desking, Multicast Paging and Conference over an IP network.

This guide provides everything you need to quickly use your new phone. Be sure to verify with your system administrator that your network is prepared for configuring your IP phone. As well, be sure to read the Packing List and Regulatory Notices sections in this guide before you set up and use the SIP-T28P IP phone.

If this is your first time using the SIP-T28P IP phone, we recommend that you first refer to the Quick Installation Guide and Quick Reference Guide. Documents are available for download at: <http://www.yealink.com/index.php/Support/>.

## In This Guide

This is the first edition based on firmware version 61.0. The topics provided in this guide include:

- Chapter 1 [Overview](#)
- Chapter 2 [Getting Started](#)
- Chapter 3 [Customizing Your Phone](#)
- Chapter 4 [Basic Call Features](#)
- Chapter 5 [Advanced Phone Features](#)



# Table of Contents

<b>About This Guide</b> .....	<b>v</b>
In This Guide.....	v
<b>Table of Contents</b> .....	<b>vii</b>
<b>Overview</b> .....	<b>1</b>
Hardware Component Instructions.....	1
Icon Instructions.....	3
LED Instructions .....	5
User Interfaces.....	6
Phone User Interface .....	6
Web User Interface.....	7
Documentation.....	9
<b>Getting Started</b> .....	<b>11</b>
Packing List.....	11
Phone Installation.....	13
Phone Initialization.....	15
Phone Status.....	16
Basic Network Settings.....	16
Registration .....	17
Idle Screen .....	17
<b>Customizing Your Phone</b> .....	<b>19</b>
General Settings.....	19
Contrast.....	19
Backlight.....	20
Language .....	21
Time and Date .....	21
Key as Send .....	24
Keypad Lock .....	24
Audio Settings.....	26
Volume.....	26
Ring Tones .....	26
Contact Management.....	27

Local Directory .....	28
Blacklist.....	32
Remote Phonebook.....	32
Call History Management.....	33
System Customizations.....	35
Logo Customization .....	35
Headset Use .....	35
DSS Keys .....	36
Account Management .....	41
Dial Plan .....	43
Emergency Number.....	46
Live Dialpad.....	46
Hot Line .....	47
<b>Basic Call Features .....</b>	<b>49</b>
Placing Calls.....	49
Answering Calls .....	51
Ending Calls .....	52
Redialing Numbers .....	53
Call Return .....	53
Call Mute.....	53
Call Hold/Resume .....	54
Do Not Disturb (DND) .....	55
Call Forward.....	55
Call Transfer .....	58
Conference.....	59
Local Conference.....	59
Network Conference .....	60
Call Park .....	61
Call Pickup.....	62
Anonymous Call.....	64
Anonymous Call Rejection.....	65
<b>Advanced Phone Features .....</b>	<b>67</b>
Busy Lamp Field (BLF).....	67
BLF List .....	68
Shared Line .....	69
Call Recording.....	71
Hot Desking.....	73
Intercom.....	74
Outgoing Intercom Calls .....	74
Incoming Intercom Calls.....	75
Multicast Paging .....	77



---

Sending RTP Stream .....	77
Receiving RTP Stream .....	78
Music on Hold .....	79
Automatic Call Distribution (ACD) .....	80
Messages .....	82
Short Message Service (SMS) .....	82
Voice Mail .....	84
Message Waiting Indicator (MWI) .....	86
<b>Troubleshooting .....</b>	<b>87</b>
<b>Regulatory Notices .....</b>	<b>91</b>
Service Agreements .....	91
Limitations of Liability .....	91
Safety Instructions .....	91
<b>Appendix A - Time Zones .....</b>	<b>93</b>
<b>Index .....</b>	<b>95</b>



# Overview

This chapter provides the overview of the SIP-T28P IP phone. The topics include:

- [Hardware Component Instructions](#)
- [Icon Instructions](#)
- [LED Instructions](#)
- [User Interfaces](#)
- [Documentation](#)



If you require additional information or assistance with your new phone, contact your system administrator.

## Hardware Component Instructions

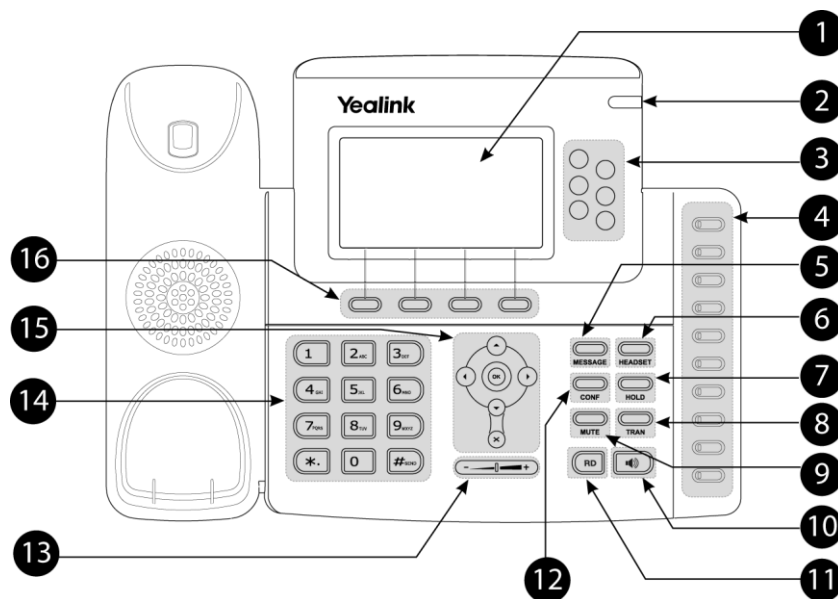
The main hardware components of the SIP-T28P IP phone are the LCD screen and the keypad.































Hardware component instructions of the SIP-T28P IP phone are:

	Item	Description
①	LCD Screen	Shows information about calls, messages, soft keys, time, date and other relevant data: <ul style="list-style-type: none"> <li>• Call information — caller ID, call duration</li> <li>• Icons (for example, <b>DND</b> )</li> <li>• Missed call text or second incoming caller information</li> <li>• Prompt text (for example, "Saving files! Please wait...")</li> <li>• Time and date</li> </ul>
②	Power Indicator LED	Indicates phone power status.
③	Line Keys	Use these keys to activate up to six accounts.
④	Memory Keys	Use these keys to assign various features. The key LED will light up when the assigned feature is enabled.
⑤	MESSAGE Key	Indicates and accesses voice messages.
⑥	HEADSET Key	Toggles and indicates the headset mode.
⑦	HOLD Key	Places a call on hold or resumes a held call.
⑧	TRAN Key	Transfers a call to another party.
⑨	MUTE Key	Toggles the Mute feature on or off.
⑩	Speakerphone Key	Toggles the hands-free speakerphone mode.
⑪	Redial Key	Redials a previously dialed number.
⑫	CONF Key	Conducts a conference call with multiple other parties.
⑬	Volume Key	Adjusts the volume of the handset, headset, speaker, and ringer.
⑭	Keypad	Provides the digits, letters, and special characters in context-sensitive applications.
⑮		Scroll through the displayed information.
		Confirms actions or answers an incoming call.
		Cancels actions or rejects an incoming call.
⑯	Soft Keys	Labels automatically to identify their context-sensitive features.

## Icon Instructions

Icons appear on the phone LCD screen are described in the following table:

Icons	Description
	Network is unavailable
	Registered successfully
	Registered fail
	Registering
	Hands-free speakerphone mode
	Handset mode
	Headset mode
	Multi-lingual lowercase letters input mode
	Multi-lingual uppercase letters input mode
	Alphanumeric input mode
	Numeric input mode
	Voice Mail
	Text Message
	Auto Answer
	Do Not Disturb
	Call Forward
	Call Hold
	Call Mute
	Ringer volume is 0

Icons	Description
	Keypad Lock
	Received Calls
	Dialed Calls
	Missed Calls
	Recording box is full
	A call cannot be recorded
	Recording starts successfully
	Recording cannot be started
	Recording cannot be stopped

## LED Instructions

### Power Indicator LED

LED Status	Description
Solid green	The phone is powered on.
Flashing green	The phone is ringing (Hardware version must be 1.0.0.1 or higher).
Off	The phone is powered off.

### Line key LED

LED Status	Description
Solid green	The line is active.
Fast flashing green	The line receives an incoming call, the phone is ringing.
Slow flashing green	The call is placed on hold.
Off	The line is inactive.

### Line key LED (configured as BLF key)

LED Status	Description
Solid green	The monitored user is idle.
Fast flashing green	The monitored user is ringing.
Slow flashing green	The monitored user is busy.
Off	The monitored user does not exist.

### Line key LED (configured as shared line key)

LED Status	Description
Solid green	All the shared line parties are idle.
Slow flashing green	The shared line is seized. Some party receives the ringback. The shared line conversation is placed on private hold. For multi-party call, all the parties place the shared line conversation on hold.
Fast flashing green	The shared line receives an incoming call. The shared line is in conversation. The shared line conversation is placed on public hold.
Off	The shared line does not exist.

### Memory key LED (configured as BLF key)

LED Status	Description
Solid green	The monitored user is idle.
Flashing red	The monitored user is ringing.

LED Status	Description
Solid red	The monitored user is busy.
Off	The monitored user does not exist.

#### Memory key LED (configured as shared line key)

LED Status	Description
Solid green	All the parties are idle.
Solid red	The shared line is seized.
Fast flashing green	Some party receives the ringback.
Fast flashing red	The shared line receives an incoming call.
Solid orange	The shared line is in conversation.
Slow flashing orange	The shared line conversation is placed on public hold.
Slow flashing green	The shared line conversation is placed on private hold.
Slow flashing red	For multi-party call, all the parties place the shared line conversation on hold.
Off	The shared line does not exist.

## User Interfaces

There are two ways to customize specific configurations on your SIP-T28P IP phone:

- Using the user interface on the IP phone.
- Using the user interface in an internet browser window from your PC.

The hardware components keypad and LCD screen constitute the phone user interface, which allows the user to execute all call operation tasks and basic configuration changes directly on the phone. In addition, you can use the web user interface to access all configuration settings. In many instances, it is possible to use both the phone user interface and the web user interface to operate the phone and change settings. However, in some instances, it is only possible to use the phone or the web user interface.

## Phone User Interface

You can customize your phone by pressing the Menu soft key to access the phone user interface. The "Advanced Settings" options are administrator level features only, the default password is admin (case-sensitive). For more information on customizing your phone using the available options from the phone user interface, refer to [Customizing Your Phone](#) on page 19.



## Web User Interface

In addition to the phone user interface, you can also customize your phone via web user interface. In order to access the web user interface, you need to know the IP address of your new phone. To obtain the IP address, press the OK key on the phone. Enter the IP address (e.g. <http://192.168.0.10> or 192.168.0.10) in the address bar of web browser on your PC. The default user name is admin (case-sensitive) and the password is admin (case-sensitive).

### Note

Please locate your PC in the same network segment of the IP phone (192.168.0.X) to access the web user interface.

The options you can use to customize the IP phone via phone user interface and/or via web user interface are listed in the following table:

Options	Phone User Interface	Web User Interface
<b>Status</b>		
--IP		
--MAC		
--Firmware	√	√
--Network		
--Phone		
--Accounts		
<b>Basic Call Features</b>		
--Call Forward	√	
--Call Park	√	
--Call Pickup	√	
--Call Return	√	√
--Conference		
--Anonymous Call	√	
--Anonymous Call Rejection	√	
--DND	√	
<b>Basic Phone Settings</b>		
--Language	√	√
--Time & Date	√	√
--Ring Tones	√	√
--Contrast	√	√
--Backlight	√	√
--Call Waiting	√	√
--Keypad Lock	√	√
--Phone Volume	√	
--Logo Customization		√
--Call History Management	√	√
--Contact Management		

Options	Phone User Interface	Web User Interface
--Local Directory	√	
--Blacklist	√	
--Remote Phonebook		
--Dial Plan		
--DSS Keys	√	√
--Key as Send	√	
--Hot Line	√	
--Live Dialpad		
--Emergency		
<b>Advanced Phone Features</b>		
--BLF/BLF List	√	
--Shared Line	√	
--Intercom	√	
--Call Recording	√	√
--Hot Desking	√	
--Multicast Paging	√	
--Music on Hold		
--ACD	√	
--Messages	√	
<b>SIP Account</b>		
--User Options		
--Register Status	√	
--Activation	√	
--Label	√	
--Display Name	√	
--Register Name	√	
--User Name	√	
--Password	√	√
--SIP Server	√	
--Server Option		
--Registrar Port		
--Outbound Status	√	
--Outbound Proxy	√	
--Backup Outbound Proxy	√	
--NAT Traversal		
--STUN Status	√	
--STUN Server	√	

**Note**

The table above lists most of the feature options. Please refer to the relevant sections for more information.

## Documentation

The following table shows documentations available for the SIP-T28P IP phone.

Name	Contents	Where found	Format/ Language
Quick Installation Guide	Basic set up of the phone	In the package	PDF/English
Quick Reference Guide	Basic call features and phone customizations	In the package	PDF/English
User Guide	Phone/ Web user interface settings Basic call features and advanced phone features	CD attached in the package	PDF/English

**Note**

You can also download the latest documentations from website:  
<http://www.yealink.com/index.php/Support/>



# Getting Started

This chapter provides basic installation instructions and information for obtaining the best performance with the SIP-T28P IP phone. The topics include:

- [Packing List](#)
- [Phone Installation](#)
- [Phone Initialization](#)
- [Phone Status](#)
- [Basic Network Settings](#)
- [Registration](#)
- [Idle Screen](#)

If you require additional information or assistance with your new phone, contact your system administrator.

## Packing List

The following components are included in your SIP-T28P IP phone package:

- **SIP-T28P IP phone**

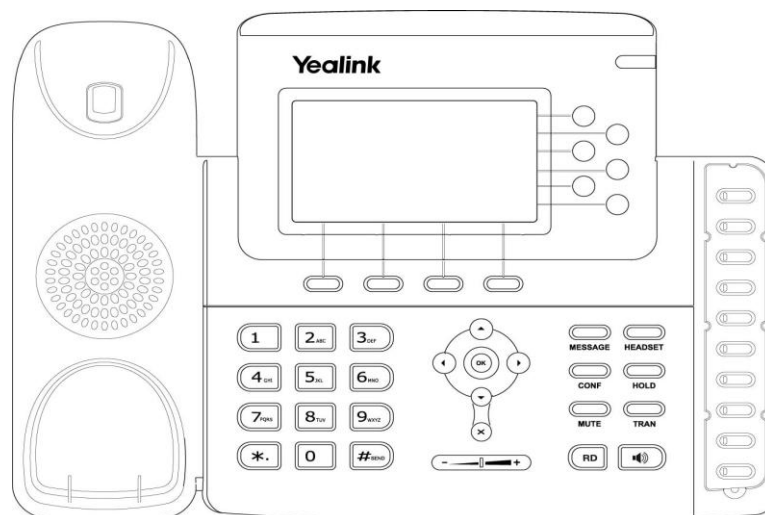

- **Phone Stand**

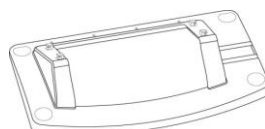

- **Power Adapter**

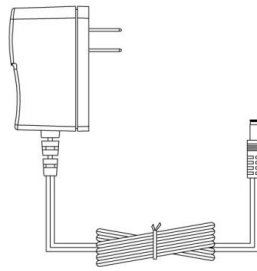

- **Handset & Handset Cord**

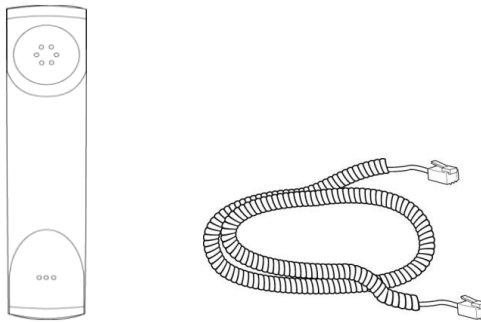

- **Ethernet Cable**

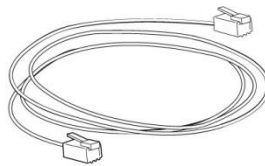

- **Quick Installation Guide & Quick Reference Guide**



- **CD-ROM**



Check the list before installation. If you find anything missing, contact your system administrator.

## Phone Installation

If your phone is already installed, proceed to [Phone Initialization](#) on page 15.

This section introduces how to install the phone with the components in the packing list:

- Attach the Stand
- Connect the Handset and optional Headset
- Connect the Network and Power

### 1) Attach the Stand:

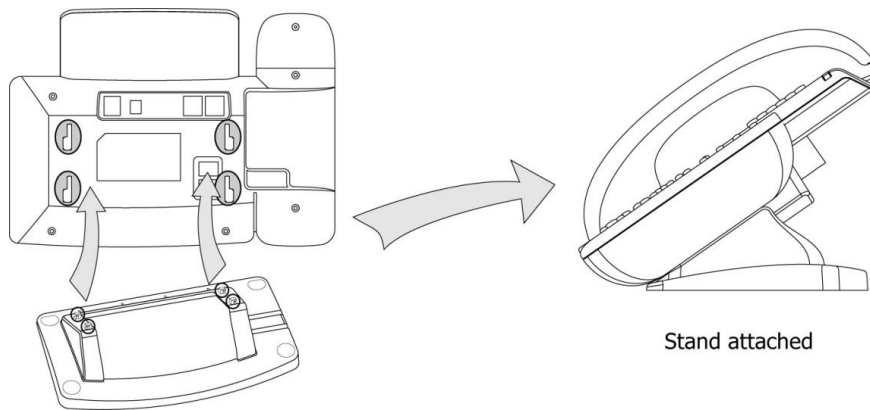

### 2) Connect the Handset and optional Headset:

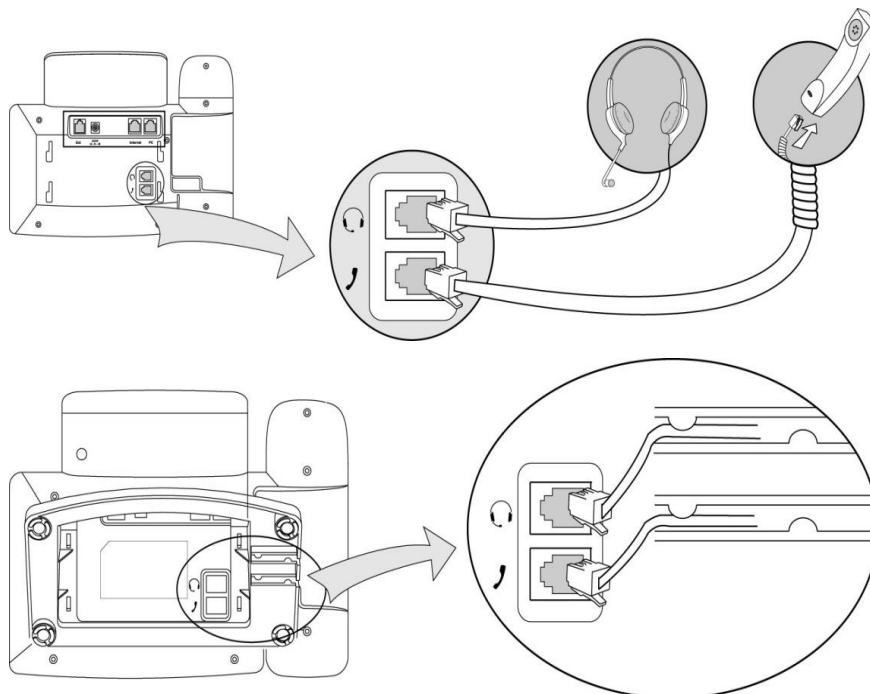

#### Note

A headset is not provided in the packing list. Contact your system administrator for more information.

### 3) Connect the Network and Power:

You have two options for power and network connections. Your system administrator will advise you which one to use.

- AC power
- Power over Ethernet (PoE)

#### AC Power

To connect the AC power:

1. Connect the DC plug on the power adapter to the DC5V port on the phone and connect the other end of the power adapter into an electrical power outlet.
2. Connect the supplied Ethernet cable between the Internet port on the phone and the Internet port in your network or switch/hub device port.

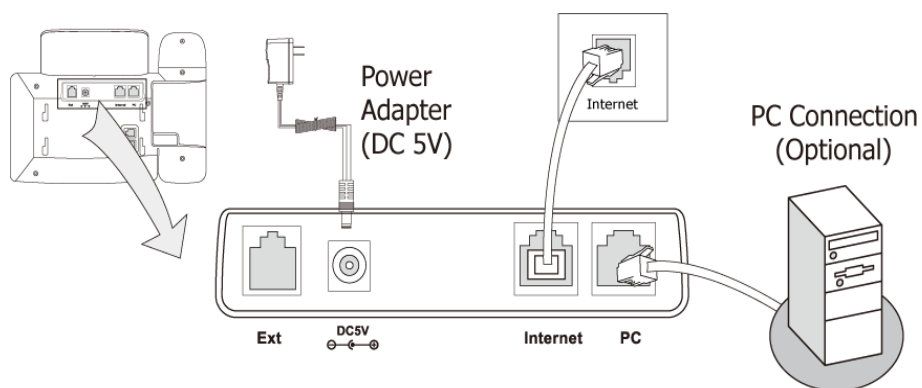

#### Power over Ethernet

Using a regular Ethernet cable, the SIP-T28P IP phone can be powered from a PoE (IEEE 802.3af) compliant switch or hub.



**To connect the PoE:**

1. Connect the Ethernet cable between the Internet port on the phone and an available port on the in-line power switch/hub.

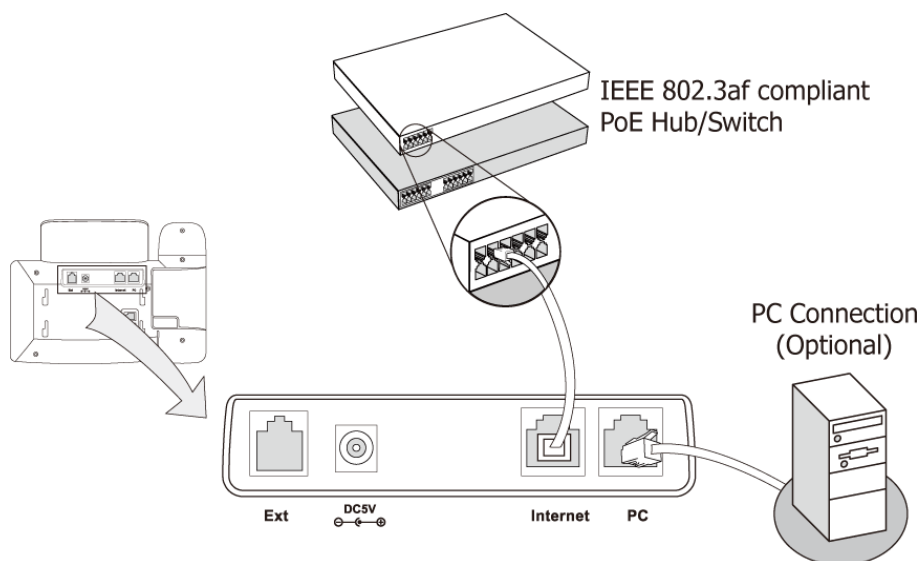
**Note**

If in-line power is provided, you don't need to connect the AC adapter. Make sure the Ethernet cable and switch/hub is PoE compliant.

The phone can also share the network with other network device such as a PC (personal computer). It is an optional connection.

**Important!** Do not unplug or remove power to the phone while it is updating firmware and configurations.

## Phone Initialization

After your phone has been powered up, the system boots up and performs the following steps:

### Automatic Phone Initialization

The phone finishes the initialization process by loading the saved configuration. The phone LCD screen will display "Initializing, Please Wait" during the initialization.

### DHCP (Dynamic Host Configuration Protocol)

By default the phone attempts to contact a DHCP server in your network in order to obtain its valid network settings, e.g. IP address, subnet mask, gateway, DNS server.

**Note**

If your network does not use DHCP, proceed to [Basic Network Settings](#) on page 16.



## Phone Status

You can view the system status of your phone via phone user interface or web user interface.

Available information of phone status includes:

- Network status including WAN port and LAN port information.
- Phone status including device model, firmware version and MAC address.
- Account status indicating the register status of sip accounts.

**To view the phone status via phone user interface:**

1. Press , or press **Menu->Status**.
2. Press  or  to scroll through the list and view the specific information.

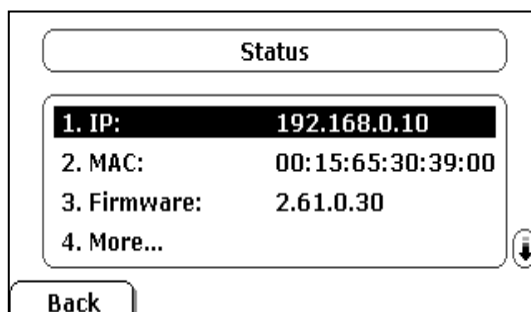

**To view the phone status via web user interface:**

1. Open the web browser of your computer.
2. Enter the IP address in the browser's address bar, and then click **Enter**.
3. Enter the **User Name** (admin) and **Password** (admin) in the pop-up dialogue box.
4. Click **OK** to log in.

## Basic Network Settings

If your phone cannot contact a DHCP server for any reason, you need to configure a static IP address manually.

**To configure a static IP address via phone user interface:**

1. Press **Menu->Settings->Advanced Settings** (password: admin) **->Network->WAN Port->Static IP Client**.

2. Enter the parameters IP, subnet mask, default gateway, primary DNS, second DNS in the corresponding fields.

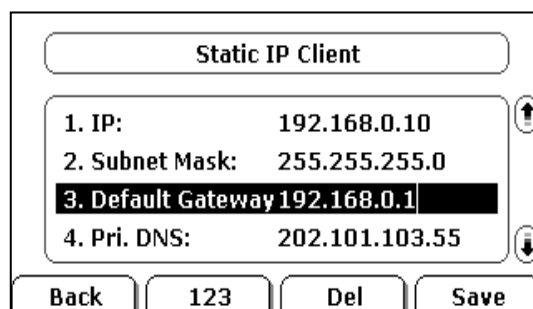

Static IP Client	
1. IP:	192.168.0.10
2. Subnet Mask:	255.255.255.0
3. Default Gateway:	192.168.0.1
4. Pri. DNS:	202.101.103.55

Back   123   Del   Save

3. Press the **Save** soft key to accept the change or the **Back** soft key to cancel.

**Note**

Using the wrong network parameters may result in inaccessibility of your phone and may also have an impact on your network performance. For more information about these parameters, contact your system administrator.

## Registration

Generally, your phone will be deployed with multiple other phones. In this case, your system administrator will configure the phone parameters beforehand, so that after you start up your phone, the phone will be registered and ready to use. If your phone is not registered, you may have to register it. For more information on how to register your phone, refer to [Account Management](#) on page 41.

## Idle Screen

If the phone has successfully started up, the idle screen will appear on the phone LCD screen as shown below.



The idle screen shows logo, time and date, label of each account and the four soft keys.



# Customizing Your Phone

You can customize your SIP-T28P IP phone by configuring the setting for time and date, display contrast, and ring tones, for example. You can add contacts to the phone's local directory manually or from call history. You can also handle incoming calls from different contacts in different ways.

This chapter provides basic operating instructions for customizing your phone. The topics include:

- [General Settings](#)
- [Audio Settings](#)
- [Contact Management](#)
- [Call History Management](#)
- [System Customizations](#)

If you require additional information or assistance with your new phone, contact your system administrator.

## General Settings



### Contrast

You can configure the contrast of the LCD screen to a comfortable level.

To configure the contrast via phone user interface:

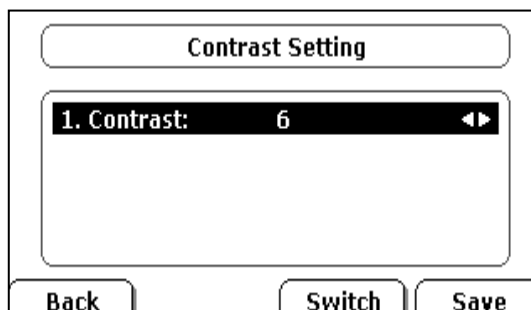
1. Press **Menu**->**Settings**->**Advanced Settings** (password: admin) ->**Phone Settings**->**Contrast**.



2. Press  or , or the **Switch** soft key to increase or decrease the intensity of contrast. The default contrast level is 6.
3. Press the **Save** soft key to accept the change or the **Back** soft key to cancel.

You can also configure contrast via web user interface at the path **Phone**->**Preference**.

## Backlight

You can configure the backlight status on the LCD screen as the following types:

- **Always off:** Backlight is turned off completely.
- **Always on:** Backlight is on permanently.
- **On (duration):** Backlight is turned off when the phone is inactive for approximately 15seconds, 30seconds, 60seconds or 120seconds.

To configure the backlight via phone user interface:

1. Press **Menu**->**Settings**->**Advanced Settings** (password: admin) ->**Phone Settings**->**Backlight**.

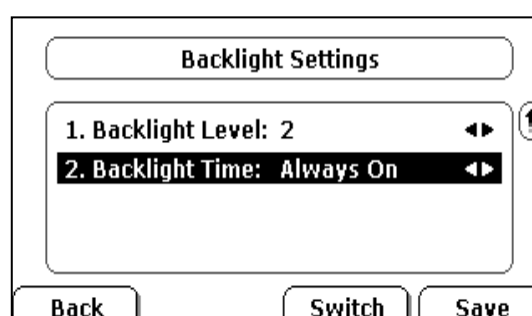

2. Press **◀** or **▶**, or the **Switch** soft key to select the desired level from the **Backlight Level** field.
3. Press **◀** or **▶**, or the **Switch** soft key to select the desired type from the **Backlight Time** field.
4. Press the **Save** soft key to accept the change or the **Back** soft key to cancel.

You can also configure the backlight via web user interface at the path **Phone**->**Preference**.

**Note** Backlight Level means the backlight intensity.



## Language

The default language of the phone user interface is English. The phone will detect and use the same language as which of your internet browser for the web user interface, if the language of your internet browser is not supported by the phone, the web user interface will use English by default. You can change the language for the phone user interface and the web user interface respectively from each other.

### Note

Not all languages are available for selection. The available languages depend on the language packs currently loaded to the IP phone. Please contact your system administrator for more information about the available languages of your new phone.

**To change the language for the phone user interface:**

1. Press **Menu->Settings->Basic Settings->Language**.
2. Press  or  to select the desired language.



3. Press the **Save** soft key to accept the change.  
Text appears on the LCD screen will change to the selected language.

**To change the language for the web user interface:**

1. Click on **Phone->Preference**.
2. Select the desired language from the pull-down list of **WEB Language**.
3. Click **Confirm** to accept the change.

Text displays on the web user interface will change to the selected language.

## Time and Date

The time and date appears on the LCD screen of the SIP-T28P IP phone. If the phone cannot obtain the time and date from the Simple Network Time Protocol (SNTP) server, contact your system administrator for more information. You can configure the phone to obtain the time and date from SNTP server automatically, or configure the time and date manually.

**To configure the SNTP settings via phone user interface:**

1. Press **Menu->Settings->Basic Settings->Time & Date->SNTP Settings**.
2. Press **◀** or **▶** , or the **Switch** soft key to select the time zone that applies to your area from the **Time Zone** field. The default time zone is "+8 China(Beijing)".
3. Enter the domain names or IP addresses in the **NTP Server1** and **NTP Server2** fields, respectively.
4. Press **◀** or **▶** , or the **Switch** soft key to select **Automatic** from the **Daylight Saving** field.

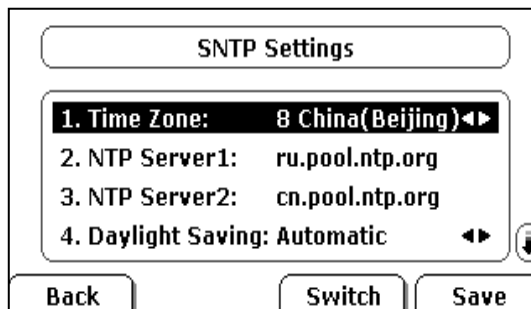

5. Press the **Save** soft key to accept the change or the **Back** soft key to cancel.

**Note**

Please refer to [Appendix A - Time Zones](#) for the list of available time zones on the IP phone.

**To configure the time and date manually via phone user interface:**

1. Press **Menu->Settings->Basic Settings->Time & Date->Manual Settings**.
2. Enter the specific **Date** and **Time**.

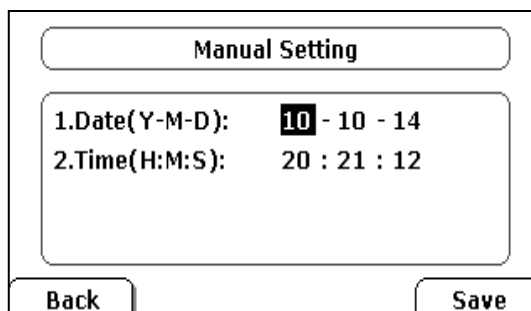



3. Press the **Save** soft key to accept the change.  
The time that appears on the LCD screen will change accordingly.



**To configure the time and date format via phone user interface:**

1. Press **Menu->Settings->Basic Settings->Time & Date->Time & Date Format**.

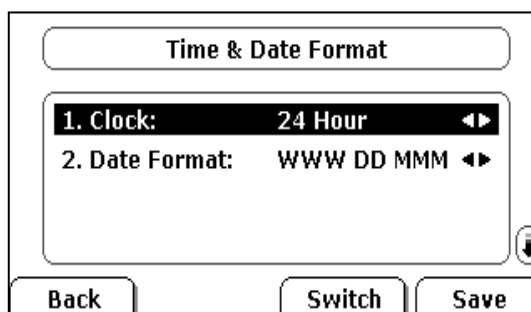

2. Press  or  , or the **Switch** soft key to select the desired time format(12 hour or 24 hour) from the **Clock** field.



3. Press  or  , or the **Switch** soft key to select the desired date format from the **Date Format** field.
4. Press the **Save** soft key to accept the change or the **Back** soft key to cancel.

There are 7 available date formats, for example, the date format "WWW DD MMM", "WWW" represents the first three letters of the week, "DD" represents two-digit of the date, and "MMM" represents the first three letters of the month.

The date formats you need to know:

Date Format	Example(2011-8-17)
WWW MMM DD	Wed Aug 17
DD-MMM-YY	17-Aug-11
YYYY-MM-DD	2011-08-17
DD/MM/YYYY	17/08/2011
MM/DD/YY	08/17/11
DD MMM YYYY	17 Aug 2011
WWW DD MMM	Wed 17 Aug

You can also configure the time and date settings via web user interface at the path **Phone->Preference**.

## Key as Send

You can set the "#" or "\*" to perform as a send key while dialing a call.

To set the key as send via phone user interface:

1. Press **Menu->Features->Key as Send**.

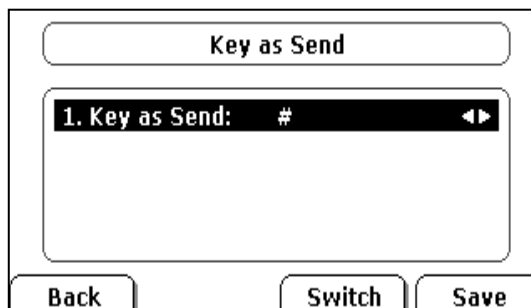

2. Press **◀** or **▶**, or the **Switch** soft key to select "#" or "\*" from the **Key as Send** field, or select **Disable** to disable this feature.
3. Press the **Save** soft key to accept the change or the **Back** soft key to cancel.

You can also configure key as send via web user interface at the path **Phone->Features**.

## Keypad Lock

You can lock the keypad of your phone when you are temporarily not using it. This feature helps you to protect your phone from unauthorized use.

This feature allows you to perform the following:

- Menu Key:** The Menu soft key is locked. You cannot access the menu of the phone until unlocked.
- Function Keys:** The function keys are locked. You cannot use the MESSAGE, RD, CONF, HOLD, MUTE, TRAN, OK, X, navigation keys, Volume key, soft keys, line keys and memory keys until unlocked.
- All Keys:** All keys are locked. You are only allowed to dial emergency numbers, answer incoming calls by lifting the handset, pressing the Speakerphone key or pressing the HEADSET key.
- Lock&Answer:** All keys are locked, except the Menu soft key and the HEADSET key. Incoming calls will be answered automatically, but cannot be ended by your party. The previous conversation is placed on hold.

### Note

The emergency number setting, if desired, must be made before lock activation. For more information, refer to [Emergency Number](#) on page 46.

**To activate the keypad lock via phone user interface:**

1. Press **Menu->Settings->Advanced Settings** (password: admin) ->**Phone Settings->Keypad Lock**.

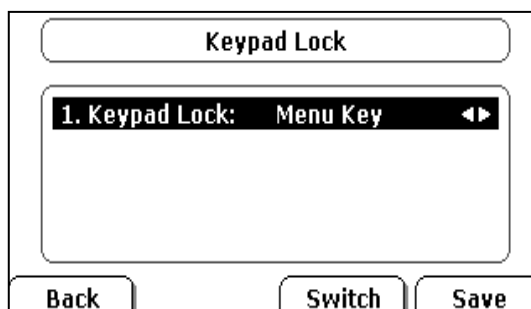

2. Press or , or the **Switch** soft key to select the desired type from the **Keypad Lock** field.
3. Press the **Save** soft key to activate the keypad lock.

The icon appears on the LCD screen. If the keypad lock feature is activated to be Lock&Answer, an additional icon will appear on the LCD screen.



**To deactivate the keypad lock via phone user interface:**

1. Press the **Menu** soft key, the LCD screen prompts for the password.
2. Enter the password (admin).
3. Press the **Confirm** soft key to deactivate the keypad lock.

The icon disappears from the LCD screen. If you want to deactivate the keypad lock type of Lock&Answer, you should press **Menu-> Settings->Advanced Settings** (password: admin) ->**Phone Settings-> Keypad Lock**, and then select **Disable** from the **Keypad Lock** field.

You can also activate or deactivate the keypad lock via web user interface at the path **Phone->Preference**.

**Note**



The default password for unlock is admin.

## Audio Settings

### Volume

You can press the Volume key to adjust the receiver volume of currently used audio devices (handset, speakerphone or headset), when the phone is in the dialing interface or during a call. You can also press the Volume key to adjust the ringer volume when the phone is idle.

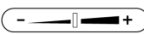
To adjust the volume via phone user interface:

1. Press **Menu->Settings->Basic Settings->Phone Volume**.
2. Select the **Handset Volume**, **Speaker Volume**, **Headset Volume** or **Ringer Volume**, and then press the **Enter** soft key.
3. Press ,  or  to adjust the volume.

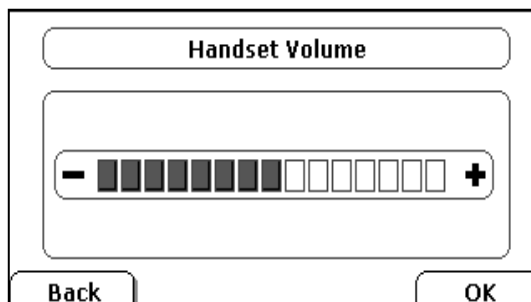

4. Press the **OK** soft key to accept the change or the **Back** soft key to cancel.

#### Note



If ringer volume is adjusted to minimum, the  icon will appear on the LCD screen.

### Ring Tones

Ring tones are used to indicate incoming calls. You can select different ring tones to distinguish the accounts or to distinguish your phone from your neighbor's.

To select a ring tone for the phone via phone user interface:

1. Press **Menu->Settings->Basic Settings->Ring Tones**.

2. Press  or  to select the desired ring tone.

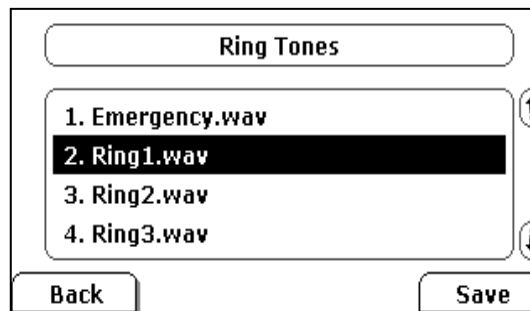

3. Press the **Save** soft key to accept the change or the **Back** soft key to cancel.

**To select a ring tone for the phone via web user interface:**

1. Click on **Phone->Preference**.
2. Select the desired ring tone from the pull-down list of **Ring Tones**.
3. Click **Confirm** to accept the change.

**To select a ring tone for the account via web user interface:**

1. Click on **Account**.
2. Select the desired account from the pull-down list of **Account**.
3. Select the desired ring tone from the pull-down list of **Ring tones**.

If **common** is selected, this account will use the ring tone selected for the phone at **Phone->Preference**. Refer to the above instruction.

4. Click **Confirm** to accept the change.

You can also upload custom ring tones for your phone, contact your system administrator for more information.

#### Note

The ring tone for an incoming call on the phone may be different. For example, when the phone receives an incoming call from a contact stored in the local directory, it will play the ring tone assigned to the contact in the contact directory (refer to [Adding Contacts](#) in the Contact Management section). Otherwise, the phone will play the ring tone assigned to the account. If both the contact ring tone and the account ring tone are not assigned, then the phone will play the ring tone assigned for the phone.

## Contact Management

This section provides the operating instructions for managing contacts. The topics include:

- [Local Directory](#)
- [Blacklist](#)
- [Remote Phonebook](#)

## Local Directory

The built-in phone directory stores the names and phone numbers of your contacts. You can store up to 300 contacts in your phone's local directory. You can add, edit, delete or search for a contact in the local directory. You can also dial a contact from the local directory.

## Adding Contacts

You can add contacts to your local directory in the following ways:

- Manually
- From call history
- From remote phonebook

### Adding Contacts Manually

To add a contact to the local directory manually:

1. Press **Directory**->**Local Directory**.
2. Select the desired contact group (For example, select **Contacts**).
3. Press the **Add** soft key.
4. Enter the **Name** and the **Office**, **Mobile** or **Other** numbers.

Add Contact	
Name:	abc
Office:	1234
Mobile:	4321
Other:	

Back    123    Delete    Save



5. Press ◀ or ▶, or the **Switch** soft key to select the desired account from the **Account** field. If **Auto** is selected, the phone will use the first available account when placing calls to the contact from the local directory.
6. Press ◀ or ▶, or the **Switch** soft key to select the desired ring tone from the **Ring Tones** field.
7. Press the **Save** soft key to accept the change or the **Back** soft key to cancel.

#### Note

If the contact has existed in the directory, the LCD screen will prompt "Existed in Contacts!".

## Adding Contacts from Call History

To add a contact to the local directory from the call history:

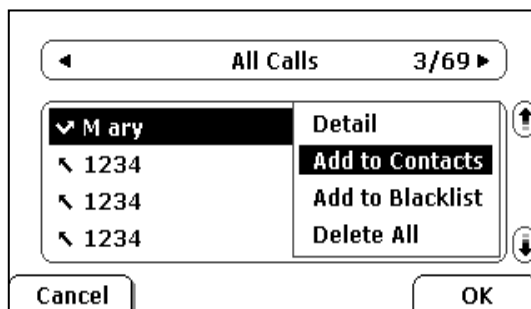

1. Press the **History** soft key.
2. Press  or  to highlight the desired entry.
3. Press the **Option** soft key, and then select **Add to Contacts** from the prompt list.



4. Enter the contact name.
5. Press the **Save** soft key to accept the change.  
The entry is successfully saved in the local directory.

## Adding Contacts from remote phonebook

To add a contact to the local directory from the remote phonebook:



1. Press **Directory->Remote Phonebook**.
2. Press  or  to highlight the desired entry.
3. Press the **Option** soft key, and then select **Move to Contacts** from the prompt list.
4. Press the **Save** soft key to save the contact in the local directory.

If the contact has already existed in the local directory, the LCD screen will prompt "Overwrite the original contact?". Press the **OK** soft key to overwrite the original contact in the local directory or the **Cancel** soft key to cancel.

For more information on remote phonebook operating, refer to [Remote Phonebook](#) on page 32.

## Editing Contacts

To edit a contact in the local directory:

1. Press **Directory->Local Directory->Contacts**.
2. Press  or  to highlight the desired contact.

3. Press the **Option** soft key, and then select **Detail** from the prompt list.

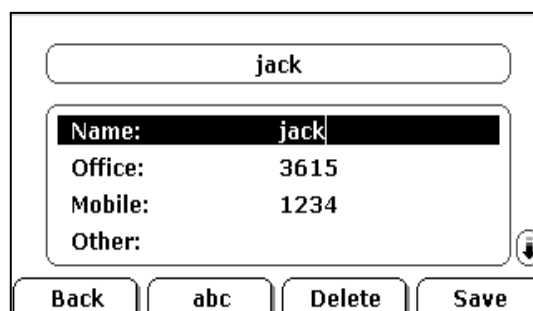

4. Press  $\uparrow$  or  $\downarrow$  to highlight the contact information and then edit.
5. Press the **Save** soft key to accept change or the **Back** soft key to cancel.

## Deleting Contacts

To delete a contact from the local directory:

1. Press **Directory**->**Local Directory**->**Contacts**.
2. Press  $\uparrow$  or  $\downarrow$  to highlight the desired contact.
3. Press the **Option** soft key, and then select **Delete** from the prompt list.

The LCD screen prompts the following warning:

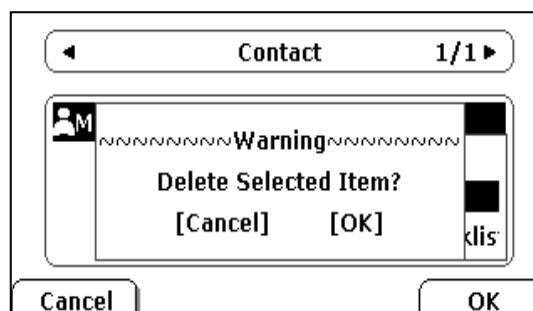

4. Press the **OK** soft key to confirm the deleting or the **Cancel** soft key to cancel.

## Placing Calls to Contacts

To place a call to a contact from the local directory:

1. Press **Directory**->**Local Directory**.
2. Select the desired contact group.
3. Press  $\uparrow$  or  $\downarrow$  to highlight the desired contact.
4. Press the **Dial** soft key.



## Searching for Contacts

To search for a contact in the local directory:

1. Press **Directory->Local Directory**.
2. Press the **Search** soft key.
3. Enter a few continuous characters of the contact name or continuous numbers of the contact phone number using the keypad.

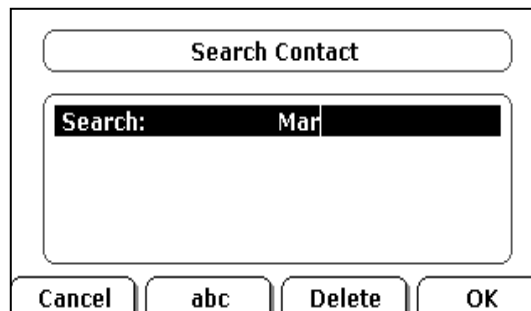

4. Press the **OK** soft key.

The contacts whose name or phone number matches the characters entered will appear on the LCD screen. You can dial from the result list.

## Importing/Exporting Contact lists

You can manage your phone's local directory via phone or web user interface. But you can only import or export the contact list via web user interface.

**To import an XML file of contact list via web user interface:**

1. Click on **Contacts->Local Directory**.
2. Click **Browse** to select a contact list file (file format must be .xml) from your local system.
3. Click **Import XML** to import the contact list.

The web user interface prompts "The original contact will be covered, continue?".

4. Click **OK** to complete importing the contact list.

**To import a CSV file of contact list via web user interface:**

1. Click on **Contacts->Local Directory**.
2. Click **Browse** to select a contact list file (file format must be .csv) from your local system.
3. Click **Import CSV** to import the contact list.

You can then select whether to delete all old contacts while importing the contact list, and select the contact information you want to import into the local directory. Such as contact name, office number or mobile number.

4. Click **Import** to complete importing the contact list.

**To export a contact list via web user interface:**

1. Click on **Contacts->Local Directory**.
2. Click **Export XML** (or **Export CSV**).
3. Click **Save** to save the contact list to your local system.

## Blacklist

The built-in phone directory stores the names and phone numbers of the blacklist. You can store up to 30 contacts in your phone's blacklist directory. You can add, edit, delete or search for a contact in the blacklist directory. You can also dial a contact in the blacklist directory, but an incoming call from the blacklist directory will be rejected automatically.

Operating instructions of adding blacklists, editing blacklists, deleting blacklists, placing call to blacklists and searching for contact in the blacklist, refer to the operating instructions of [Local Directory](#) on page 28.

## Remote Phonebook

You can access your corporate directory through your phone. You can add contacts from the corporate directory to your local directory. You can also dial a contact from the corporate directory.

You can configure your new phone to access up to 5 corporate directories. Contact your system administrator for the access URL of the corporate directory.

**To configure an access URL for remote phonebook via web user interface:**

1. Click on **Contacts->Remote PhoneBook**.
2. Enter the access URL in the **Phone Book Url** field.
3. Enter the name in the **Phone Book Name** field.
4. Click **Confirm** to accept the change.

**To access your corporate directory via phone user interface:**

1. Press **Directory->Remote Phonebook**.
2. Select the desired remote group, and then press the **Enter** soft key.

The phone connects to load the corporate directory, and then displays the corporate contact list on the LCD screen.

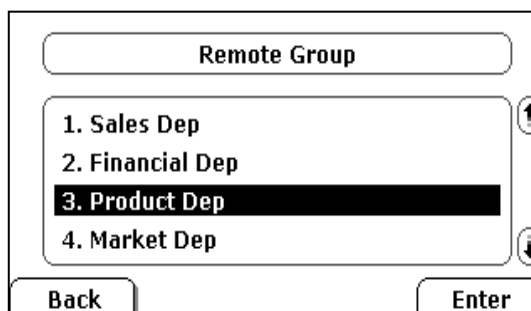

3. Press the **Cancel** soft key to back to the previous interface or the **Back** soft key to disconnect.

#### To place a call from the corporate directory:

1. Press **Directory**->**Remote Phonebook**.
2. Select the desired remote group, and then press the **Enter** soft key to load the corporate directory.
3. Select the desired contact in the corporate directory.
4. Press the **Dial** soft key.

In addition, you can enable the phone to present the caller identity stored in the corporate directory when receiving a call.

#### To enable the presentation of caller identity stored in the remote phonebook:



1. Click on **Phone**-> **Features**.
2. Select **Enabled** from the pull-down list of **SRemoteName**.
3. Enter the refresh period of corporate directory in the **SRemoteNameFlashTime** field. The default value is 3600 seconds.
4. Click **Confirm** to accept the change.

## Call History Management





The SIP-T28P IP phone maintains call history lists of Dialed Calls, Received Calls, Missed Calls and Forwarded Calls. The call history list supports up to 100 entries in all. You can check the call history, dial a call, add a contact or delete an entry from the call history list.

#### To check the call history:





1. Press the **History** soft key.  
The LCD screen displays **All Calls** list.
2. Press **◀** or **▶** to switch between **All Calls**, **Dialed Calls**, **Received Calls**, **Missed Calls** and **Forwarded Calls**.

3. Press  or  to select the desired entry.
4. Press the **Option** soft key, and then select **Detail** from the prompt list.  
The detailed information of the entry appears on the LCD screen.

**To dial a call from the call history list:**





1. Press the **History** soft key.
2. Press  or  to switch between **All Calls, Dialed Calls, Received Calls, Missed Calls** and **Forwarded Calls**.
3. Press  or  to select the desired entry.
4. Press the **Send** soft key.

**To add a contact from the call history list:**



1. Press the **History** soft key.
2. Press  or  to switch between **All Calls, Dialed Calls, Received Calls, Missed Calls** and **Forwarded Calls**.
3. Press  or  to select the desired entry.
4. Press the **Option** soft key, and then select **Add to Contacts** (or **Add to Blacklist**) from the prompt list.

For more information, refer to [Contact Management](#) on page 27.

**To delete an entry from the call history list:**

1. Press the **History** soft key.
2. Press  or  to switch between **All Calls, Dialed Calls, Received Calls, Missed Calls** and **Forwarded Calls**.
3. Press  or  to select the desired entry.
4. Press the **Delete** soft key.

**To delete all entries from the call history list:**

1. Press the **History** soft key.
2. Press  or  to switch between **All Calls, Dialed Calls, Received Calls, Missed Calls** and **Forwarded Calls**.
3. Press the **Option** soft key, and then select **Delete All** from the prompt list.
4. Press the **OK** soft key.  
The LCD screen prompts "Delete all records?".
5. Press the **OK** soft key to confirm the deleting or the **Cancel** soft key to cancel.

## System Customizations

### Logo Customization

You can upload your custom logo which will be shown on the idle screen.

**To upload a custom logo via web user interface:**

1. Click on **Phone->Features**.
2. Select **Custom Logo** from the pull-down list of **Use Logo**.
3. Click **Browse** to select the logo file from your local system.
4. Click **Upload** to upload the file.
5. Click **Confirm** to accept the change.
6. Reboot the phone, the custom logo will be shown on the LCD screen after rebooting.

#### Note

The logo file format must be “.dob”, contact your system administrator for more information.

### Headset Use

Physically connect your headset, refer to [Phone Installation](#) on page 13 and activate/deactivate it for use.

### Headset Activation/Deactivation

**To activate the headset mode:**

1. Press  on the phone.

The HEADSET key LED illuminates solid green indicates that the headset mode is activated. Press the line key or the **Answer** soft key to receive a call, the call will connect to your headset automatically.

**To deactivate the headset mode:**

1. Press  again on the phone.

The HEADSET key LED turns off when the headset mode is deactivated.

### Headset Prior

You can use headset in priority when enabling the headset prior feature. This feature is especially useful for permanent or full-time headset users.

**To enable Headset Prior via web user interface:**

1. Click on **Phone->Features**.
2. Select **Enabled** from the pull-down list of **Headset Prior**.
3. Click **Confirm** to accept the change.

**To use headset prior, you should activate the headset mode in advance:**

1. Physically connect the headset.
2. Press  to activate the headset mode.

**Note**

If headset prior feature is enabled, the headset mode will not be deactivated until you press the HEADSET key again.

## Dual Headset

You can use two headsets when enabling the dual headset feature. To use this feature, you must physically connect headsets both to the headset jack and handset jack respectively. Once the phone joins in a call, people with the headset connected to the headset jack has a full-duplex conversation, another people with the headset connected to the handset jack is only allowed to listen to.

**To enable Dual Headset via web user interface:**

1. Click on **Phone->Features**.
2. Select **Enabled** from the pull-down list of **Dual Headset**.
3. Click **Confirm** to accept the change.

## DSS Keys

There are three types of DSS keys: Memory Keys, Line Keys and Programmable Keys. The details will be introduced as following. The use of line keys and memory keys are almost the same. The SIP-T28P IP phone supports 10 memory keys and 6 line keys.

## Memory Keys

You can assign predefined functionalities to the memory keys located on the right of the phone. Memory keys allow you to use quick access features such as Call Return and Voice Mail. The memory keys LED will indicate the monitoring status when the keys are assigned specific features, such as BLF and Shared Line. The default key type of each memory key is N/A, which indicates that this memory key provides no functionality.

**To configure the memory key via phone user interface:**

1. Press **Menu->Features->DSS Keys->Memory Keys**.
2. Select the desired memory key, and then press the **Enter** soft key.

3. Select the desired key type from the **Type** field.
4. (Optional.) Select the desired key event type from the **Key Type** field.
5. (Optional.) Select the desired line from the **Account ID** field.
6. (Optional.) Enter the corresponding value in the **Value** field.
7. (Optional.) Enter the corresponding value in the **Extension** field.
8. Press the **Save** soft key to accept the change or the **Back** soft key to cancel.

You can also configure the memory key via web user interface at the path **Phone->DSS Keys->Memory Keys**.

The memory key features are explained in the following subchapters in detail:

- Line
- Speed Dial
- DTMF
- Prefix
- Conference
- Forward
- Transfer
- Hold
- DND
- Redial
- SMS
- Group Listening

For more information, contact your system administrator.

### Line

You can use this key feature to accept the incoming calls, place active calls on hold or resume a held call. It performs the same as a hard line key.

**Dependencies:** *Type (Line)*

*Account ID (the account this feature will be applied to)*

**Usage:** When receiving an incoming call, the DSS key LED flashes green:

1. Press the DSS key to accept the incoming call.
2. Press the DSS key to place the active call on hold.
3. Press the DSS key again to resume the held call.

If **Auto** is selected from the **Account ID** field, press the DSS key when the phone is idle, you can then dial out using the first registered account.

### Speed Dial

You can use this key feature to speed up dialing the numbers often used or hard to remember.

**Dependencies:** *Type (Speed Dial)*

*Value (the number you want to dial out)*

*Account ID (the account this feature will be applied to)*

**Usage:** Press the DSS key to dial out the number specified in the **Value** field, using the account selected from the **Account ID** field.

## DTMF

You can use this key feature to send the specification of arbitrary key sequences via DTMF.

**Dependencies:** *Type (Key Event)*

*Key Type (DTMF)*

*Value (DTMF sequence)*

### Note

DTMF sequence is allowed to be: "0-9", "\*", "#" and "A-D".

**Usage:** Press the DSS key during an active call to send the key sequence specified in the **Value** field.

## Prefix

You can use this key feature to dial a call with a specified prefix number.

**Dependencies:** *Type (Key Event)*

*Key Type (Prefix)*

*Value (the prefix number)*

**Usage:** Press the DSS key when the phone is idle, the phone will be ready to make a new call and show up the prefix number which you specified in the **Value** field, enter other digits and then dial out.

## Conference

You can use this key feature to set up a conference call. For more information, refer to [Conference](#) on page 59.

**Dependencies:** *Type (Key Event)*

*Key Type (Conf)*

*Value (the number you want to add to the conference)*

**Usage:** Press the DSS key during an active call to set up a conference with the number specified in the **Value** field.

### Note

When leaving the **Value** field blank, the DSS key performs the same as the **CONF** key or the **Conf** soft key during a call.



## Forward

You can use this key feature to forward an incoming call to someone else. For more information, refer to [Call Forward](#) on page 55.

**Dependencies:** *Type (Key Event)*

*Key Type (Forward)*

*Value (the number you want to forward to)*

**Usage:** Press the DSS key to forward an incoming call to the number specified in the **Value** field.

### Note

When leaving the **Value** field blank, the DSS key performs the same as the **Forward** soft key when receiving an incoming call.

## Transfer

You can use this key feature to perform a Blind/Attended/Semi-Attended Transfer during a call. For more information, refer to [Call Transfer](#) on page 58.

**Dependencies:** *Type (Key Event)*

*Key Type (Transfer)*

*Value (the number you want to transfer to)*

**Usage:** Press the DSS key during a call to transfer the call to the number specified in the **Value** field.

### Note

When leaving the **Value** field blank, the DSS key performs the same as the **TRAN** key or the **Transfer** soft key during a call.

## Hold

You can use this key feature to place an active call on hold or retrieve a held call.

**Dependencies:** *Type (Key Event)*

*Key Type (Hold)*

**Usage:**

1. Press the DSS key during an active call to place the call on hold.
2. Press the DSS key again to retrieve the held call.

## DND

You can use this key feature to activate or deactivate the DND mode.

**Dependencies:** *Type (Key Event)*

*Key Type (DND)*

**Usage:**

1. Press the DSS key to activate the DND mode.

2. Press the DSS key again to deactivate the DND mode.

**Note**

When the DND mode is activated, all incoming calls will be rejected automatically.

### Redial

You can use this key feature to access the **Dialed Calls** list. Press the DSS key when the phone is idle, then you can select an entry to redial.

**Dependencies:** *Type (Key Event)*

*Key Type (Redial)*

**Usage:**

1. Press the DSS key when the phone is idle to access the dialed calls list.
2. Select an entry and press the DSS key again to redial the call.

### SMS

You can use this key feature to quick access the text message feature. For more information, refer to [Short Message Service \(SMS\)](#) on page 82.

**Dependencies:** *Type (Key Event)*

*Key Type (SMS)*

**Usage:** Press the DSS key when the phone is idle to access the text message feature.

### Group Listening

You can use this key feature to activate the Speakerphone and Handset/Headset mode at the same time. It is suitable for the group conversation which has more than one person at one side. You are able to speak and listen through the handset/headset, meanwhile the others nearby can only listen through the speaker.

**Dependencies:** *Type (Key Event)*

*Key Type (Group Listening)*

**Usage:**

1. During a call, press the DSS key to activate group listening mode.  
You can then speak and listen through the handset/headset, other people at your side can listen through speaker at the same time.
2. Press the DSS key again to deactivate group listening mode.

## Line Keys

You can assign predefined functionalities to the line keys. You can also define a label for the line key feature which will appear on the LCD screen. The default key type of each line key is Line.

**To configure the line key via phone user interface:**

1. Press **Menu->Features->DSS Keys->Line Keys**.

2. Select the desired line key, and then press the **Enter** soft key.
3. Select the desired key type from **Type** field.
4. (Optional.) Select the desired key event type from the **key type** field.
5. (Optional.) Select the desired line from the **Account ID** field.
6. (Optional.) Enter the string that will appear on the LCD screen in the **Label** field.
7. (Optional.) Enter the corresponding value in the **Value** field.
8. (Optional.) Enter the corresponding value in the **Extension** field.
9. Press the **Save** soft key to accept the change or the **Back** soft key to cancel.

You can also configure the line key via web user interface at the path **Phone->DSS Keys->Line Keys**.

For more information on using the line keys, refer to [Memory Keys](#) introduced above.

## Programmable Keys

You can customize the soft keys, navigation keys and function keys on the keypad.

**To customize the programmable keys via web user interface:**

1. Click on **Phone->DSS Keys->Programmable Keys**.
2. Customize specific features for these keys.
3. Click **Confirm** to accept the change.

### Note

You can configure the programmable keys via web user interface only.

## Account Management

You can register one or multiple accounts on the SIP-T28P IP phone. You can also configure each line key associated with an account or configure multiple line keys associated with an account.

## Account Registration

**To register an account via phone user interface:**

1. Press **Menu->Settings->Advanced Settings** (password: admin) ->**Accounts**.
2. Select the desired account and then press the **Enter** soft key.
3. Select **Enable** from the **Activation** field.
4. Enter the **Label, Display Name, Register Name, User Name, Password** and **SIP Server** respectively. Contact your system administrator for more information.
5. Press the **Save** soft key to accept the change or the **Back** soft key to cancel.
6. Repeat steps 2 to 5 until you have registered all accounts.

The following figures show single or multiple accounts registered on the phone:

**Single account:**



**Multiple accounts:**



**To disable an account via phone user interface:**

1. Press **Menu**->**Settings**->**Advanced Settings** (password: admin) ->**Accounts**.
2. Select the desired account and then press the **Enter** soft key.
3. Select **Disable** from the **Activation** field.
4. Press the **Save** soft key to accept the change or the **Back** soft key to cancel.

You can also register or disable an account via web user interface at the path **Account**->**Basic**.

## Multiple Line Keys per Account

You can configure multiple line keys associated with an account. This enhances call visualization and simplifies call handling. If this is the case, the LCD screen could resemble the following figure:



Incoming calls to this line will be distributed evenly among the available line keys. Similarly, outgoing calls will be distributed.

Your phone can be configured to have a combination of lines with a single line key and lines with multiple line keys.

## Dial Plan

Dial plan is a string of characters that governs the way your SIP-T28P IP phone processes the inputs received from your phone keypad. The SIP-T28P IP phone supports the following dial plan features:

- [Replace Rule](#)
- [Dial-now](#)
- [Area Code](#)
- [Block Out](#)

The basic expression syntax you need to know:

.	The dot "." can be used as a placeholder or multiple placeholders for any character. Example: "12." would match "123", "1234", "12345", "12abc", etc.
x	An "x" can be used as a placeholder for any character. Example: "12x" would match "121", "122", "123", "12a", etc.
[]	The square brackets "[]" can be used as a placeholder for a single character which matches any of a set of characters. Example: "91[5-7]1234" would match "9151234", "9161234", "9171234", etc.
()	The parentheses "( )" can be used to group together patterns, for instance, to logically combine two or more patterns. Example: "([1-9])([2-7])3" would match "923", "153", "773", etc.
\$	Followed by the sequence number of a pattern. Example: A replace rule configuration: Prefix: "9([5-7])(.)", Replace: "5\$2". When you enter "95123" to dial out on your phone, the number will be replaced as "5123" and then dialed out.

**Note** You can configure the dial plan rules via web user interface only.

## Replace Rule

You can configure one or more replace rules to remove the specified string and replace it with another string. You can configure a pattern with wildcards (expression syntax refer to the table above), so that any string that matches the pattern will be replaced. This feature is designed for convenience when you try to dial out a number. For example, a replace rule is configured as "Prefix: 1" and "Replace: 1234567", then when you try to

dial out the number "1234567", you just need to enter "1" on the phone and then press the Send soft key.

**To add a replace rule via web user interface:**

1. Click on **Phone->Dial Plan->Replace Rule**.
2. Enter the string (e.g. 2xx) in the **Prefix** field.
3. Enter the string (e.g. 12345) in the **Replace** field.
4. Enter the desired line ID in the **Account** field or leave it blank.
5. Click **Add** to add the replace rule.

When you enter the number "234" using the keypad and then dial out, the phone will dial out "12345" instead.

**Note**

The valid value of **Account** field can be one or more digits among 1, 2, 3, 4, 5 and 6. Each digit must be separated by a ",". For example: when you enter the value "1, 2" in the **Account** field, this replace rule will apply to account1 and account2.

If you leave the **Account** field blank or enter an invalid value, then the replace rule will apply to all accounts.

**To edit a replace rule via web user interface:**

1. Click on **Phone->Dial Plan->Replace Rule**.
2. Select the desired replace rule by checking the check box.
3. Edit the values in the **Prefix** and **Replace** fields.
4. Enter the desired line ID in the **Account** field or leave it blank.
5. Click **Edit** to accept the change.

**To delete one or more replace rules via web user interface:**

1. Click on **Phone->Dial Plan->Replace Rule**.
2. Select the one or more replace rules by checking the check box(es).
3. Click **Del** to delete the replace rule(s).

## Dial-now

You can configure one or more dial-now rules on your phone. When the dialed out number matches the dial-now string, the number will be dialed out automatically. For example, a dial-now rule is configured as "2xx", then entering any three-digit string begins with 2 will be dialed out automatically on the phone.

**To add a dial-now rule via web user interface:**

1. Click on **Phone->Dial Plan->Dial-now**.
2. Enter the desired value (e.g. 1234) in the **Dial-now Rule** field.
3. Enter the desired line ID in the **Account** field or leave it blank.

4. Click **Add** to add the dial-now rule.  
When you enter the number "1234" using the keypad, the phone will dial out "1234" automatically without pressing any key.

**Note**

You can also edit or delete the dial-now rule, refer to [Replace Rule](#) on page 43 for more information.

**Time Out for Dial-now Rule**

You can configure the interval for dial-now rules. That is, you can configure your phone to dial out the phone number, which matches a dial-now rule, in a fixed time.

**To configure the timeout for dial-now rule via web user interface:**

1. Click on **Phone->Features**.
2. Enter the time within 0-14 (in seconds) in the **Time Out for Dial-now Rule** field.
3. Click **Confirm** to accept the change.

**Area Code**

Area codes are also known as Numbering Plan Areas (NPAs). They usually indicate geographical areas in a country. This feature is necessary only when dialing outside the code area. For example, area code is configured as "Code: 011, Min Length: 4, Max Length: 11", then when you dial out the number "56789", the phone will add the area code and dial out the number "01156789".

**To configure the area code and lengths via web user interface:**

1. Click on **Phone->Dial Plan->Area Code**.
2. Enter the desired values in the **Code**, **Min Length** and **Max Length** fields.
3. Enter the desired line ID in the **Account** field or leave it blank.
4. Click **Confirm** to accept the change.

**Note**

The default values of minimum and maximum length are 1 and 15 respectively.

**Block Out**

You can block the dialing of specific numbers. When you dial a block out number on your phone, the dialing will fail and the LCD screen will prompt "Forbidden Number".

**To add a block out number via web user interface:**

1. Click on **Phone->Dial Plan->Block Out**.
2. Enter the desired value in the **Block Out Number** field.
3. Enter the desired line ID in the **Account** field or leave it blank.
4. Click **Add** to add the block out number.

## Emergency Number

Public telephone networks in countries around the world have a single emergency telephone number (emergency services number), that allows a caller to contact local emergency services for assistance when required. The emergency telephone number may differ from country to country. It is typically a three-digit number so that it can be easily remembered and dialed quickly. Some countries have a different emergency number for each of the different emergency services.

You can specify the emergency telephone numbers on the IP phone for contacting the emergency services in an emergency situation.

### Note

Contact your local phone service provider for available emergency numbers in your area.

#### To specify emergency numbers via web user interface:

1. Click on **Phone->Features**.
2. Enter the emergency services number in the **Emergency** field. For multiple numbers, enter a "," between each emergency number (Default value for this field is blank).
3. Click **Confirm** to accept the change.

## Live Dialpad

You can enable the live dialpad feature on the SIP-T28P IP phone, which enables the IP phone to automatically dial out the phone number without pressing any other key. You can also configure a period of time before automatically dialing out the phone number.

#### To enable the live dialpad via web user interface:

1. Click on **Phone->Preference**.
2. Select **Enable** from the pull-down list of **Live Dialpad**.
3. Enter the desired delay time (0~14s) in the **Inter Digit Time** field.
4. Click **Confirm** to accept the change.

### Note

The default delay time of live dialpad feature is 4s.  
You can configure live dialpad via web user interface only.



## Hot Line

You can dial a hotline number immediately once you lift the handset, press the speakerphone key or press a line key. You can also configure to dial out the hotline number in a period of time, the phone will dial out the hotline number automatically after the specified delay time.

To configure the hot line number via phone user interface:

1. Press **Menu->Features->Hot Line**.
2. Enter the desired number in the **Number** field.
3. Enter the delay time (seconds) in the **HotLine Delay** field.

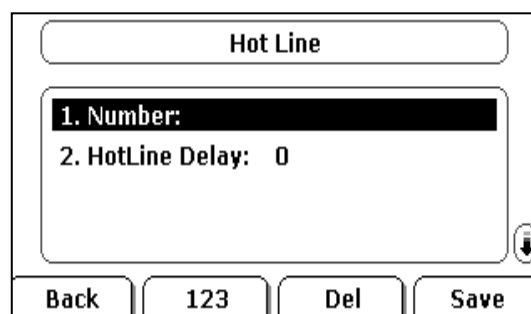

The screenshot shows a phone's user interface for configuring a Hot Line. At the top, there is a title bar labeled "Hot Line". Below the title bar, there are two input fields. The first field is labeled "1. Number:" and is currently empty. The second field is labeled "2. HotLine Delay: 0" and contains the value "0". To the right of the second field, there is a small icon of a hand with a downward arrow. At the bottom of the screen, there are four soft keys: "Back", "123", "Del", and "Save".

4. Press the **Save** soft key to accept the change or the **Back** soft key to cancel.

You can also configure hot line via web user interface at the path **Phone->Features**.



## Basic Call Features

---

The SIP-T28P IP phone is designed to be easily used like a regular phone on a public switched telephone network (PSTN). You can place calls, answer calls, transfer a call to someone else, or conduct a conference call.

This chapter provides basic operating instructions for the SIP-T28P IP phone. The topics include:

- [Placing Calls](#)
- [Answering Calls](#)
- [Ending Calls](#)
- [Redialing Numbers](#)
- [Call Return](#)
- [Call Mute](#)
- [Call Hold/Resume](#)
- [Do Not Disturb \(DND\)](#)
- [Call Forward](#)
- [Call Transfer](#)
- [Conference](#)
- [Call Park](#)
- [Call Pickup](#)
- [Anonymous Call](#)
- [Anonymous Call Rejection](#)

If you require additional information or assistance with your new phone, contact your system administrator.

## Placing Calls

You can place a call in three ways using your SIP-T28P IP phone:

- Using the handset
- Using the speakerphone
- Using the headset

You can also dial the number first, and then choose the way you want to speak to the other party.

You can search the call history, the local contact directory or the remote phonebook and



dial from the search results. For more information, refer to [Contact Management](#) on page 27 and [Call History Management](#) on page 33.

During a call, you can alternate between Speakerphone, Headset, or Handset modes by pressing the Speakerphone key, the HEADSET key, or picking up the handset.

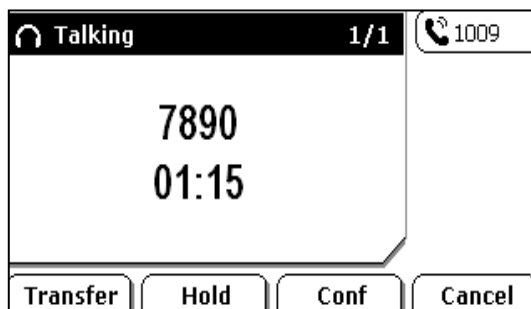
The call duration of active calls is visible on the LCD screen. In the figure below, the call to the number "7890" has lasted 1 minute and 15 seconds.



#### To place a call using the handset:

1. Pick up the handset.
2. Enter the desired number using the keypad.
3. Press  ,  , or the **Send** soft key.

By default, the # key is set as a send key. You can set the \* key as send key or set neither of them as send keys. For more information, refer to the [Key as Send](#) on page 24.







#### Note

You can also dial using the SIP URI or IP address. To obtain the IP address of your phone, press the **OK** key. The maximum SIP URI or IP address length is 32 characters. For example, 192.168.1.15, sip:2210@sip.com.

Your phone may not support direct IP dialing. Contact your system administrator for more information.

#### To place a call using the hands-free speakerphone mode:

Do one of the following:



- With the handset on-hook, press  or the line key to obtain a dial tone.  
Enter the desired number using the keypad.  
Press  ,  , or the **Send** soft key.
- With the handset on-hook, enter the desired number using the keypad.  
Press  ,  ,  , or the **Send** soft key.

#### To place a call using the headset:

Do one of the following:



- With the optional headset connected, press  to activate the headset mode.  
Press the line key to obtain a dial tone.

Enter the desired number using the keypad.

Press  ,  , or the **Send** soft key.

- With the optional headset connected, press  to activate the headset mode.

Enter the desired number using the keypad.





Press  ,  , or the **Send** soft key.



### Note

To permanently enable your headset, refer to [Headset Prior](#) on page 35.

### To place multiple calls:

You can have more than one call on your SIP-T28P IP phone. To place a new call during an active call, do one of the following:

- Press the line key. The active call is placed on hold.  
Enter the desired number using the keypad.  
Press  ,  , or the **Send** soft key.
- Press  or the **Hold** soft key to place the original call on hold.  
Press the **NewCall** soft key.  
Enter the desired number using the keypad.  
Press  ,  , or the **Send** soft key.

You can press  or  to switch between the calls, and then press the **Resume** soft key to retrieve the desired call.

## Answering Calls

When you are not in another call, you can answer a call in three ways:

- Using the handset
- Using the speakerphone
- Using the headset

### Note

You can ignore incoming calls by pressing the **X** key, the **Reject** soft key or the **Silence** soft key. You can also activate Do Not Disturb mode to ignore all incoming calls without ring on your phone. For more information, refer to [Do Not Disturb \(DND\)](#) on page 55.

You can forward incoming calls to someone else by pressing the **Forward** soft key. For more information, refer to [Call Forward](#) on page 55.

### Answering When Not in Another Call

In all cases, the active call will appear on the LCD screen showing call duration and destination.

**To answer a call using the handset:**

1. Pick up the handset.

**To answer a call using the hands-free speakerphone mode:**

Do one of the following:

- Press  .
- With the handset on-hook and the headset mode deactivated, press the **Answer** soft key.
- With the handset on-hook and the headset mode deactivated, press the line key (the line key LED flashes green).



**To answer a call using the headset:**

Do one of the following:

- Press  .
- With the headset mode activated, press the **Answer** soft key.
- With the headset mode activated, press the line key (the line key LED flashes green).

**Answering When in Another Call**

If you have an active call, and an incoming call arrives on the phone, do one of the following:

- Press the **Answer** soft key.  
The incoming call is answered and the original call is placed on hold.
- Press  to access the new call.  
Press  or the **Answer** soft key.  
The incoming call is answered and the original call is placed on hold.

## Ending Calls

**To end a call:**

Do one of the following:

- If you are using the handset, press the **Cancel** soft key or hang up the handset.
- If you are using a headset, press the **Cancel** soft key.
- If you are using the speakerphone, press  or the **Cancel** soft key.

**Note**





To end a call placed on hold, you can press the **Cancel** soft key to end the call directly, or press the **Resume** soft key to resume the call before ending it.

## Redialing Numbers

To redial the last placed call from your phone:

1. Press  twice.  
A call to your last placed call is attempted.





To redial a previously placed call from your phone:

1. Press  when the phone is idle.
2. Press  or  to select the desired entry from the dialed calls list, and then press  or the **Send** soft key.

## Call Return

You can press a call return key to place a call back to the last incoming call.

To configure a call return key via phone user interface:

1. Press **Menu->Features->DSS Keys->Memory Keys** (or **Line Keys**).
2. Select a desired DSS key.
3. Press  or , or the **Switch** soft key to select **Key Event** from the **Type** field.
4. Press  or , or the **Switch** soft key to select **Call Return** from the **Key Type** field.

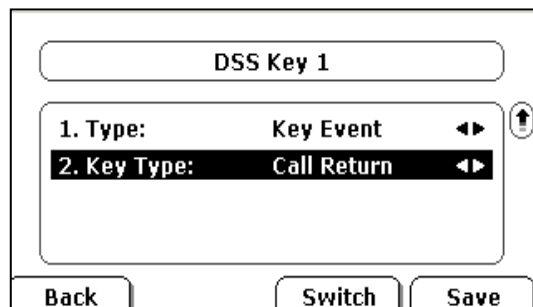

5. Press the **Save** soft key to accept the change or the **Back** soft key to cancel.

You can also configure a call return key via web user interface at the path **Phone->DSS Keys**.

## Call Mute

You can mute the microphone of the active audio device during an active call, then the other party cannot hear you.

To mute a call:

1. Press  during an active call.

The phone LCD screen indicates that the call is on mute.

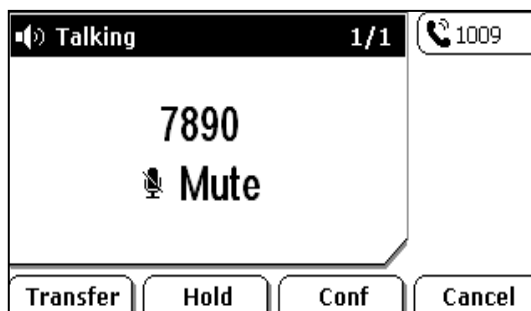

**To un-mute a call:**

1. Press  again to un-mute the call.

## Call Hold/Resume

You can place an active call on hold. At any time, at most one active call can be in progress on your phone, other calls can be received and made while placing the original call on hold. When placing a call on hold, your IP PBX might play a melody or message to the other party while waiting.

**To place a call on hold:**

1. Press  or the **Hold** soft key during a call.

The phone LCD screen shows the call is on hold and the line key LED flashes green.





### Note

The phone will beep softly every 30 seconds to remind you that you still have a call on hold.

**To resume a held call:**

1. Press  or the **Resume** soft key.

**Multiple Calls on Hold:**

If multiple calls are placed on hold, press  or  to switch between the calls, and then press the **Resume** soft key to retrieve the desired call.



If more than two calls are on hold, an indication appears on the LCD screen, for example "2/4", indicating that this is the second call out of four calls.

If multiple calls are on hold on more than one line keys, you can view the details of the calls by pressing the corresponding line key, and then press the **Resume** soft key to retrieve the call.

## Do Not Disturb (DND)

You can enable or disable the Do Not Disturb (DND) mode on the phone. If DND mode is enabled, the phone will reject all incoming calls automatically, and the callers will hear a busy signal or a message, depending on how your system administrator set up the configuration server.

### To activate DND mode on the SIP-T28P IP phone:

1. Press the **DND** soft key when the phone is idle.

The **DND** icon on the idle screen indicates that the Do Not Disturb mode is enabled. Incoming calls will be rejected automatically and "**n New Missed Call**" ("n" indicates the number of the missed call) will prompt on the LCD screen.

#### Note



The Do Not Disturb feature is local to the phone, and may be overridden by the server settings. For more information, contact your system administrator.

## Call Forward

You can configure your phone to forward incoming calls to another party by the Static Forwarding. You can also forward calls while your phone rings, refer to the Dynamic Forwarding.

### Static Forwarding

#### To enable call forward:

1. Press **Menu->Features->Call Forward**.
2. Press  or  to select the desired forwarding type, and then press the **Enter** soft key. The options are:

**Always Forward:** Incoming calls are immediately forwarded.

**Busy Forward:** Incoming calls are immediately forwarded if the phone is busy.

**No Answer Forward:** Incoming calls are forwarded if not answered after a period of time.

3. Depending on your selection:
  - a.) If you select **Always Forward**:

- 1) Press ◀ or ▶ , or the **Switch** soft key to select **Enable** from the **Always** field.
- 2) Enter the destination number you want to forward all incoming calls to in the **Forward to** field.
- 3) (Optional.) Enter the always forward on code or always off code respectively in the **On Code** or **Off Code** field.

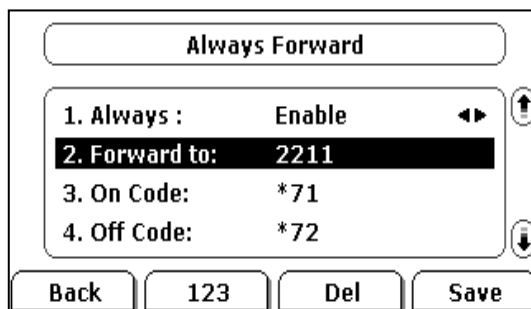

b.) If you selected **Busy Forward**:

- 1) Press ◀ or ▶ , or the **Switch** soft key to select **Enable** from the **Busy** field.
- 2) Enter the destination number you want to forward all incoming calls to when the phone is busy in the **Forward to** field.
- 3) (Optional.) Enter the busy forward on code or busy off code respectively in the **On Code** or **Off Code** field.

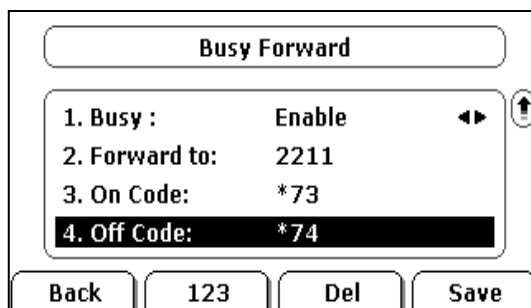

c.) If you selected **No Answer Forward**:

- 1) Press ◀ or ▶ , or the **Switch** soft key to select **Enable** from the **No Answer** field.
- 2) Enter the destination number you want to forward all unanswered incoming calls to in the **Forward to** field.
- 3) Press ◀ or ▶ , or the **Switch** soft key to select the ring time to wait before forwarding in the **After Ring Time** field (The default ring time is 60 seconds).

- 4) (Optional.) Enter the no answer forward on code or off code respectively in the **On Code** or **Off Code** field.

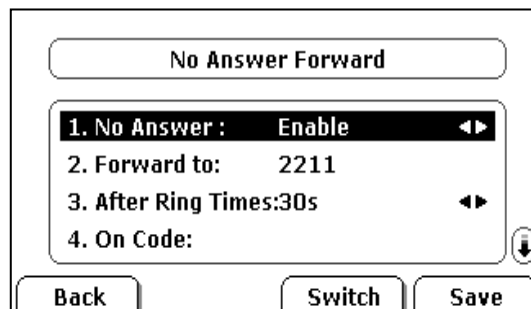

4. Press the **Save** soft key to accept the change or the **Back** soft key to cancel.

The  icon on the idle screen indicates the call forward is enabled.

You can also configure forward feature via web user interface at the path **Phone->Features**.





#### Note

You can also enter the SIP URL or IP address in the **Forward to** field. For more information on using the SIP URL or IP address, refer to [Placing Calls](#) on page 49.

Call forward feature is local to the phone, and may be overridden by the server settings. Call forward on code or off code may be different between servers. For more information, contact your system administrator.

#### To disable call forward:

Do one of the following:

- Press  when the phone is idle.
- Press **Menu->Features->Call Forward**.  
Press  or  to select the desired forwarding type, then press the **Enter** soft key.  
Press  or , or the **Switch** soft key to select **Disable** to disable the call forward.

## Dynamic Forwarding

#### To forward an incoming call to another party:

1. When the phone rings, press the **Forward** soft key.

2. Enter the number you want to forward the incoming call to.

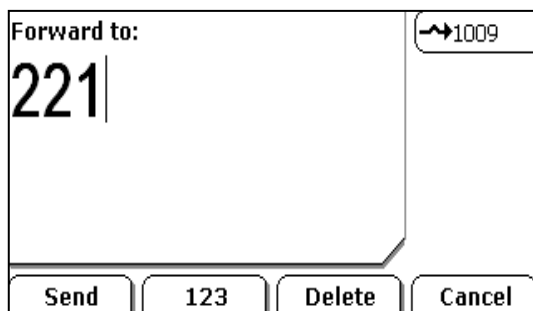

3. Press  ,  , or the **Send** soft key.

The LCD screen prompts a call forward message.

## Call Transfer

You can transfer a call to another party in one of the three ways:

- **Blind Transfer:** Transfer a call directly to another party without consulting.
- **Semi-Attended Transfer:** Transfer a call when the target phone is ringing.
- **Attended Transfer:** Transfer a call with prior consulting.

**To perform a blind transfer:**





1. Press  or the **Transfer** soft key during a call.
2. Enter the number you want to transfer the call to.







3. Press  or the **Transfer** soft key to complete the transfer.

Then the call is connected to the number to which you are transferring.

**To perform a semi-attended transfer:**

1. Press  or the **Transfer** soft key during a call.
2. Enter the number you want to transfer the call to.
3. Press  or  to dial out.
4. Press  or the **Transfer** soft key to complete the transfer when receiving ringback.

**To perform an attended transfer:**

1. Press  or the **Transfer** soft key during a call.
2. Enter the number you want to transfer the call to.
3. Press  or  to dial out.
4. After the party answers the call, press  or the **Transfer** soft key to complete the transfer.

If you are using a handset, the transfer can be completed by hanging up the handset.

You can cancel the transfer before the call connects by pressing the **Cancel** soft key.

## Conference

You can create a conference with other parties using the phone's local conference feature. You can create a conference between an active call and a call on hold (on the same or another line) by pressing the **CONF** key or the **Conf** soft key. The network conference feature allows you to add and remove specific conference parties.



### Note

The network conference feature is not available on all servers. For more information, contact your system administrator.

## Local Conference

The SIP-T28P IP phone supports up to 3 parties (including yourself) in a conference call. This is called Local Conference and is the default method of conference.

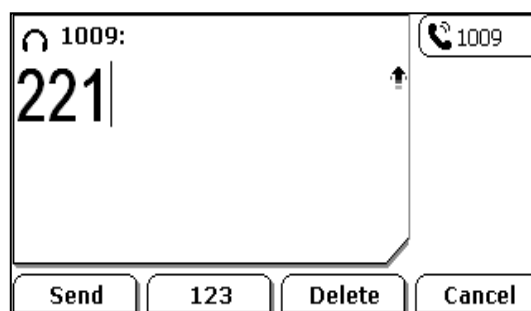

**To set up a local conference call:**

1. Place a call to the first party.
2. Press  or the **Conf** soft key to create a new call  
The active call is placed on hold.
3. Enter the number of the second party and press , , or the **Send** soft key.



4. When the second party answers the call, you can consult with him or her before adding to the conference.
5. Press  or the **Conf** soft key again to join all parties in the conference.

**To join two calls in a conference:**

1. Place two calls using two different accounts on the phone (for example, place the first call using account 1, and then place the second call using account 2).
2. Press  or  to select the call for conference and make sure the call is active (for example, select the call on account 1).
3. Press  or the **Conf** soft key to join the two calls in the conference on account 1.

You can press  or the **Hold** soft key to place the conference on hold. You can press the **Split** soft key to split the conference call into two individual calls. To drop the conference call, press the **Cancel** soft key.

## Network Conference

You can use network conference feature on the SIP-T28P IP phone to conduct a conference with multiple participants.







This feature allows you to perform the following:

- Join two calls together into a conference call.
- Invite another party into an active conference call.

To use this feature, contact your system administrator for the network conference-URI in advance, and configure the phone via web user interface:

1. Click on **Account->Advanced**.
2. Select the desired conference type from the pull-down list of **Conference Type**.
3. Enter the conference URI (e.g. conference@example.com) in the **Conference URI** field.
4. Click **Confirm** to accept the change.

**To set up a network conference call:**

1. Place a call to the first party.
2. Press  or the **Conf** soft key to create a new call.  
The active call is placed on hold.
3. Enter the number of the second party and press , , or the **Send** soft key.
4. When the second party answers the call, press  or the **Conf** soft key to add the second party to the conference.
5. Press the **Conf** soft key to create a new call.  
The conference is placed on hold.
6. Enter the number of the new party and then press , , or the **Send** soft key.
7. When the new party answers the call, press  or the **Conf** soft key to add the new party to the conference.
8. Repeat steps 5 to 7 until you have added all intended parties.

The procedures to set up a network conference call for specific servers may be different from introduced above. Contact your system administrator for more information.

## Call Park

You can use call park feature to place a call on hold, and then retrieve the call from another phone in the system (for example, a phone in another office or conference room). You can park an active call by pressing the call park key on the phone. If the call is parked successfully, the response is either a voice prompt confirming that the call was parked, or a visible indication on the LCD screen. When the call is parked successfully, someone can retrieve the parked call on another phone.

### Note

Call Park feature is not available on all servers. Contact your system administrator for more information.

#### To configure a call park key via phone user interface:

1. Press **Menu->Features->DSS Keys->Memory Keys** (or **Line Keys**).
2. Select the desired DSS key.
3. Press ◀ or ▶, or the **Switch** soft key to select **Key Event** from the **Type** field.
4. Press ◀ or ▶, or the **Switch** soft key to select **Call Park** from the **Key Type** field.
5. Press ◀ or ▶, or the **Switch** soft key to select the desired line from the **Account ID** field.
6. Enter the call park feature code (contact your system administrator for it) in the **Value** field.

DSS Key 1	
1. Type:	Key Event
2. Key Type:	Call Park
3. Account ID:	Line 1
4. Value:	*68

Back   2aB   Del   Save

7. Press the **Save** soft key to accept the change or the **Back** soft key to cancel.

You can also configure a call park key via web user interface at the path **Phone->DSS Keys**.

#### To use the Call Park feature:

1. User on phone A places a call to phone B.
2. User on phone A wants to take the call in a conference room for privacy, then presses the call park key on phone A.

3. (Optional.)The SIP Server sends the first available call park extension (e.g.150), will appear on the LCD screen of phone A.
4. The user on phone A walks to an available conference room where the phone is designated as phone C. The user dials the call park retrieve code (or the call park extension (e.g. 150)) to retrieve the parked call.

The system establishes call between phone C and B.

**Note**

The call park feature code and call park extension are predefined on the system server. Contact the system administrator for more information.

If the parked call is not retrieved within a period time assigned by the system, the phone performing call park feature will receive call back.

## Call Pickup

You can press a pickup key to answer someone else’s incoming call on the phone. The SIP-T28P IP phone supports the directed call pickup and group call pickup features. Directed call pickup is used for picking up a call that is ringing at a specific phone number. Group call pickup is used for picking up a call that is ringing at any phone number in the group. The pickup group should be predefined, contact your system administrator for more information.

**Note**

If there are many incoming calls at the same time, press the pickup key on the phone will pick up the call that rings first.

### Directed Call Pickup

To configure a pickup key via phone user interface:

1. Press **Menu->Features->DSS Keys->Memory keys** (or **Line keys**).
2. Select the desired DSS key.
3. Press **◀** or **▶** , or the **Switch** soft key to select **Key Event** from the **Type** field.
4. Press **◀** or **▶** , or the **Switch** soft key to select **Pick Up** from the **Key Type** field.
5. Press **◀** or **▶** , or the **Switch** soft key to select the desired line from the **Account ID** field.

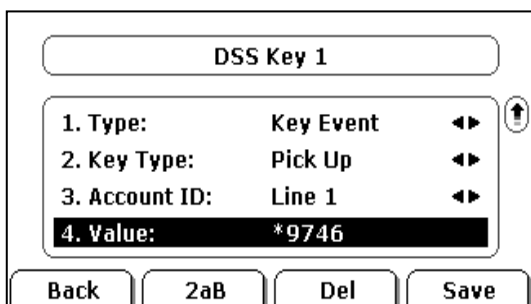



6. Enter the pickup code followed by the specific phone number you want to pick up in the **Value** field.
7. Press the **Save** soft key to accept the change or the **Back** soft key to cancel.

You can also configure a direct pickup key via web user interface at the path **Phone->DSS Keys**.

#### To pick up a call directly:

1. Press the pickup key on your phone when the specific phone number receives an incoming call.  
The call is answered on your phone.

## Group Call Pickup

#### To configure a group pickup key via phone user interface:

1. Press **Menu->Features->DSS Keys->Memory Keys** (or **Line Keys**).
2. Select the desired DSS key.
3. Press ◀ or ▶, or the **Switch** soft key to select **Key Event** from the **Type** field.
4. Press ◀ or ▶, or the **Switch** soft key to select **Group Pick Up** from the **Key Type** field.
5. Press ◀ or ▶, or the **Switch** soft key to select the desired line from the **Account ID** field.
6. Enter the group pickup feature code in the **Value** field.

DSS Key 1	
1. Type:	Key Event
2. Key Type:	Group Pick Up
3. Account ID:	Line 1
4. Value:	*98

Back    2aB    Del    Save

7. Press the **Save** soft key to accept the change or the **Back** soft key to cancel.

You can also configure a group pickup key via web user interface at the path **Phone->DSS Keys**.

#### To pick up a call in the group:

1. Press the group pickup key on your phone when a phone number in the group receives an incoming call.  
The call is answered on your phone.

## Anonymous Call

You can use anonymous call feature to block the identity and phone number from showing up to the called party when you call someone. For example, you want to call to consult some of the services, but you don't want to be harassed.

**Note**

The anonymous call feature is not available on all servers. Contact your system administrator for the anonymous call on code and off code.

**To configure anonymous call via phone user interface:**

1. Press **Menu->Features->Anonymous Call**.
2. Press **◀** or **▶** , or the **Switch** soft key to select the desired line from the **Line ID** field.
3. Press **◀** or **▶** , or the **Switch** soft key to select **Enable** from the **Anonymous Call** field.
4. (Optional.) Enter the anonymous call on code in the **Call On Code** field.
5. (Optional.) Enter the anonymous call off code in the **Call Off Code** field.

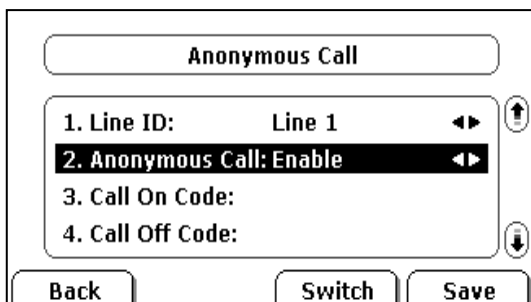

6. Press the **Save** soft key to accept the change or the **Back** soft key to cancel.

You can also configure anonymous call via web user interface at the path **Account->Basic**.

**To place an anonymous call:**



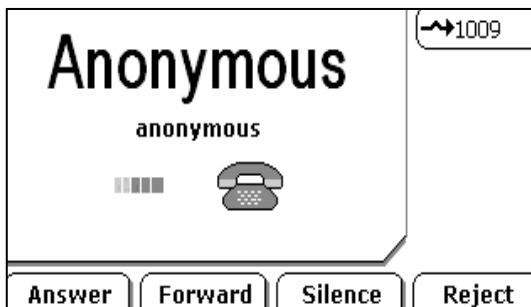



1. Using the specific line on the phone to place a call to phone B.  
The LCD screen of phone B prompts an incoming call from anonymity.



## Anonymous Call Rejection

You can use anonymous call rejection feature to reject incoming calls from anonymous callers. Anonymous call rejection automatically rejects incoming calls from callers who deliberately block their identities and numbers from showing up.

**To configure anonymous call rejection via phone user interface:**

1. Press **Menu->Features->Anonymous Call**.
2. Press  or  , or the **Switch** soft key to select the desired line from the **Line ID** field.
3. Press  or  to scroll to the **Rejection** field.
4. Press  or  , or the **Switch** soft key to select **Enable** from the **Rejection** field.
5. (Optional.) Enter the anonymous call rejection on code in the **Reject On Code** field.
6. (Optional.) Enter the anonymous call rejection off code in the **Reject Off Code** field.
7. Press the **Save** soft key to accept the change or the **Back** soft key to cancel.

You can also configure anonymous call rejection via web user interface at the path **Account->Basic**.



# Advanced Phone Features

This chapter provides operating instructions for the advanced features of the SIP-T28P IP phone. The topics include:

- [Busy Lamp Field \(BLF\)](#)
- [BLF List](#)
- [Shared Line](#)
- [Call Recording](#)
- [Hot Desking](#)
- [Intercom](#)
- [Multicast Paging](#)
- [Music on Hold](#)
- [Automatic Call Distribution \(ACD\)](#)
- [Messages](#)





If you require additional information or assistance with your new phone, contact your system administrator.

## Busy Lamp Field (BLF)

You can use the BLF feature to monitor a specific user for status changes on the phone. For example, you can configure a BLF key on the phone for monitoring the status of a friend's phone (busy or idle). When the friend picks up his phone to make a call, the BLF key (memory key) LED illuminates solid red on your phone to indicate that the friend's phone is in use and busy. For more BLF key LED indications, refer to [LED Instructions](#) on page 5.

You can press a BLF key to dial out the monitored user when he is in idle. You can also pick up a call directly by pressing the BLF key when the monitored user is ringing. For more information, contact your system administrator.

### To configure a BLF key via phone user interface:

1. Press **Menu->Features->DSS Keys->Memory Keys** (or **Line Keys**).
2. Select the desired DSS key.
3. Press  or  , or the **Switch** soft key to select **BLF** from the **Type** field.
4. Press  or  , or the **Switch** soft key to select the desired line from the **Account ID** field.
5. Enter the phone number or extension you want to monitor in the **Value** field.

- (Optional.) Enter the pickup code in the **Extension** field.

DSS Key 1	
1. Type:	BLF
2. Account ID:	Line 1
3. Value:	3601
4. Extension:	*88

Back    2aB    Del    Save

- Press the **Save** soft key to accept the change or the **Back** soft key to cancel.

You can also configure the BLF key via web user interface at the path **Phone->DSS Keys**.

## BLF List

You can use the BLF List feature to monitor a list of users defined by your system administrator. For example, your system administrator enables BLF List, and creates a BLF List URI (e.g., BLFList@example.com) including a list of user1, user2 and user3 on the server. You can configure BLF List keys on the phone to monitor the status changes of user1, user2 and user3. The key LEDs illuminate either flashing or solid depending on the status of those users. For more BLF List key LED indications, refer to [LED Instructions](#) on page 5.

You can use the BLF List keys in the following ways:

- When the monitored user is in idle, press the BLF List key to dial out the phone number.
- When the monitored user is ringing, press the BLF List key to pick up the call directly.
- When there is a conversation on the monitored user, press the BLF List key to barge in and set up a conference call.

**To configure the BLF List settings via web user interface:**

- Click on **Account**.
- Select the desired account from the **Account** field.
- Click on **Advanced**.
- Enter the BLF List URI in the **BLF List URI** field.
- (Optional.) Enter the BLF pickup code in the **BLF List Code** field.
- (Optional.) Enter the BLF barge in code in the **BLFListBargeInCode** field.
- Click **Confirm** to accept the change.

### Note

For more information about the BLF List pickup and BLF List barge in feature, contact your system administrator.

You can configure the BLF List settings via web user interface only.

**To assign BLF List keys via phone user interface:**

1. Press **Menu->Features->DSS Keys->Memory Keys** (or **Line Keys**).
2. Select the desired DSS key.
3. Press ◀ or ▶, or the **Switch** soft key to select **BLF List** from the **Type** field.
4. Press ◀ or ▶, or the **Switch** soft key to select the desired line from the **Account ID** field.

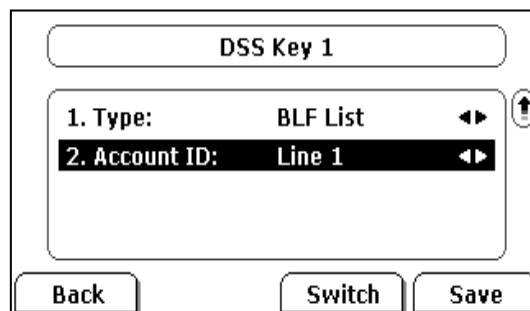

5. Press the **Save** soft key to accept the change.
6. Repeat steps 2 to 5 to configure more BLF List keys.

You can also configure the BLF List key via web user interface at the path **Phone->DSS Keys**.

After the above configurations, according to the response message from the BLF List server, the IP phone will automatically assign the phone number of the BLF List users to the BLF List keys in order.

## Shared Line

Shared line is configured by assigning the same extension number to multiple lines. You can use the shared line feature to share an extension number which is used on two or more IP phones at the same time. An incoming call to that number will cause all phones to ring simultaneously. The incoming call can be answered on one of the phones but not all of them. This feature is very useful in the boss and secretary scenario. For example, the secretary can share the boss' extension number by configuring a shared line key on her phone. When there is an incoming call to the extension number of the boss, both the phones of the boss and the secretary will ring simultaneously. Either the boss or the secretary can answer the call. Calls on shared line can be placed on hold or barged in.

### Note

The shared Line feature is not available on all servers. For more information, contact your system administrator.

**To place a call on public hold:**





1. Press , the shared line key or the **Hold** soft key, when there is an active call on the shared line.

**To retrieve a call placed on public hold:**

1. Press the shared line key on any phone when there is a public held call on the shared line.

The shared line key LED illuminates flashing when the shared line call is placed on public hold. For more Shared Line key LED indications, refer to [LED Instructions](#) on page 5.

**To place the call on private hold, you should configure a private hold key in advance:**

1. Press **Menu->Features->DSS Keys->Memory Keys** (or **Line Keys**).
2. Select the desired DSS key.
3. Press  or , or the **Switch** soft key to select **Key Event** from the Type field.
4. Press  or , or the **Switch** soft key to select **Private Hold** from the **Key Type** field.

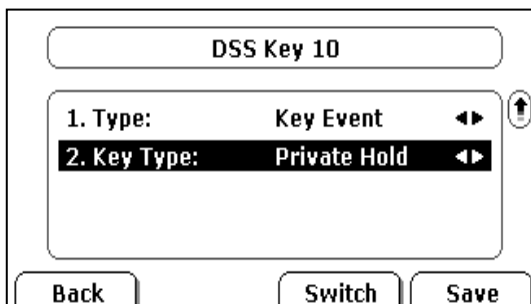

5. Press the **Save** soft key to accept the change.

You can also configure a private hold key via web user interface at the path **Phone->DSS Keys**.

**To place a call on private hold:**

1. Press the private hold key when there is an active call on the shared line.

**Note**

The private held call can be only retrieved by the hold party.  
If the call is placed on private hold, and you attempt to pick up the call by pressing the shared line key, the retrieve will fail and the LCD screen will prompt "Forbidden".

**To barge in a shared line call:**

1. Press the shared line key on any other phone when there is an active call on the shared line.

For more shared line key LED instructions, refer to [LED Instructions](#) on page 5.



## Call Recording

You can record calls by pressing a record key on the SIP-T28P IP phone. There are 2 different ways of configuring call recording and they even work differently:

- **Record:** The phone sends SIP INFO message containing a specific header to trigger a recording.
- **URL Record:** The phone sends HTTP URL request to trigger a recording. Contact your system administrator for the predefined URL.

### Note

The record feature is not available on all servers. Contact your system administrator for more information.

To configure a Record key via phone user interface:

1. Press **Menu->Features->DSS Keys->Memory Keys** (or **Line Keys**).
2. Select the desired DSS key.
3. Press ◀ or ▶, or the **Switch** soft key to select **Key Event** from the **Type** field.
4. Press ◀ or ▶, or the **Switch** soft key to select **Record** from the **Key Type** field.

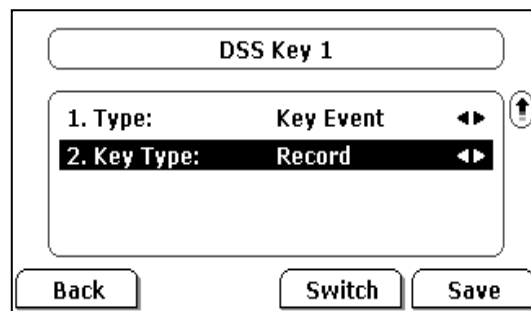

5. Press the **Save** soft key to accept the change or the **Back** soft key to cancel.

To configure a URL Record key via phone user interface:

1. Press **Menu->Features->DSS Keys->Memory Keys** (or **Line Keys**).
2. Select the desired DSS key.
3. Press ◀ or ▶, or the **Switch** soft key to select **URL Record** from the **Type** field.
4. Enter the URL (e.g. <http://10.1.2.224/phonerecording.cgi>) in the **Value** field.
5. Press the **Save** soft key to accept the change or the **Back** soft key to cancel.

You can also configure the Record or URL Record keys via web user interface at the path **Phone->DSS Keys**.

The Record/URL Record keys control the recording and are available:

- During an active call
- When calls are on hold or mute

- During a blind or attended transfer
- During a conference call
- When the phone prompts you to answer an incoming call





**The Record/ URL Record keys are not available:**

- When there are no connected calls on your phone
- When you place a new call

**To record a call:**

1. Press a Record or URL Record key during a call.  
If the recording starts successfully, the recording icon appears on the LCD screen and the Record or URL Record key LED flashes green.
2. Press the Record or URL Record key again to stop recording.  
The recording icon disappears from the LCD screen and the Record or URL Record key LED turns off.

Recording status indications you need to know:

Circumstance	Icons on the LCD screen
A recording is started	 appears on the LCD screen
A recording cannot be started	 appears for 1 second
A recording cannot be stopped	 appears for 1 second, then goes back
The recording box is full	 appears for 1 second
The cannot be recorded	 appears for 1 second

You can listen to the recordings stored on your server system. For example, you can dial an access code to listen to the recordings.

**Note** The way listening to the recordings may be different on different servers. Contact your system administrator for more information.

## Hot Desking

Hot Desking originates from the definition of being the temporary physical occupant of a work station or surface by a particular employee. A primary motivation for Hot Desking is cost reduction. This feature is regularly used in places where not all the employees are in the office at the same time, or not in the office for very long at all, which means actual personal offices would be often vacant, consuming valuable space and resources.

You can use Hot Desking on the SIP-T28P IP phone to log out the existing accounts and then log in a new account, that is, many users can share the phone resource in different time. To use this feature, you need to configure a Hot Desking key in advance.

### Note

The hot desking feature is not available on all servers. Contact your system administrator for more information.

To configure a hot desking key via phone user interface:

1. Press **Menu->Features->DSS Keys->Memory Keys (or Line Keys)**.
2. Select the desired DSS key.
3. Press **◀** or **▶**, or the **Switch** soft key to select **Key Event** from the **Type** field.
4. Press **◀** or **▶**, or the **Switch** soft key to select **Hot Desking** from the **Key Type** field.
5. Leave the **Value** field blank.

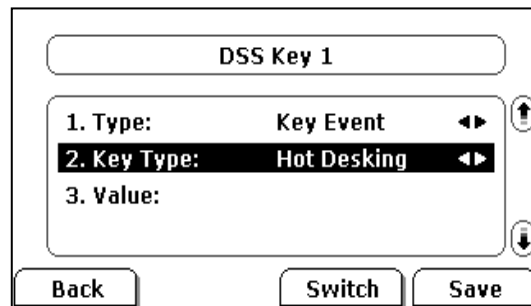

6. Press the **Save** soft key to accept the change or the **Back** soft key to cancel.

You can also configure a hot desking key via web user interface at the path **Phone->DSS Keys**.

To use hot desking:

1. Press the hot desking key when the phone is idle.

The phone prompts the following warning:

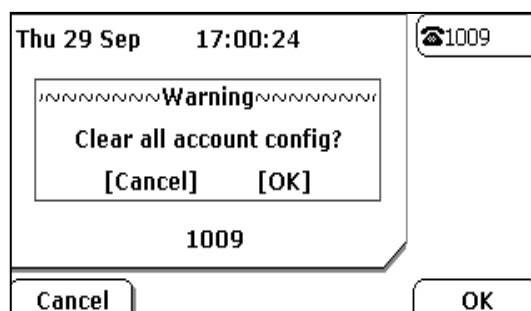

2. Press the **OK** soft key, all currently configured accounts will be unregistered immediately and their configuration data will be removed from the phone.
3. The login wizard will be shown as below:

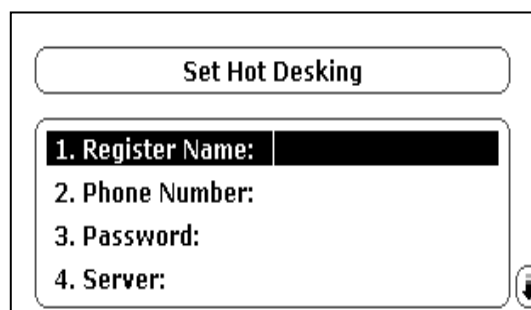

4. Enter the Login information in each field.  
After successfully login, you can place calls, receive messages, answer calls, etc.
5. Press the hot desking key again to log out.

## Intercom

Intercom is a useful feature in an office environment to quickly connect with the operator or the secretary. You can press the configured intercom key to automatically connect with a remote extension for outgoing intercom calls, and the remote extension will automatically answer the incoming intercom calls.

### Note

The intercom feature is not available on all servers. Contact your system administrator for more information.

## Outgoing Intercom Calls

To configure an intercom key via phone user interface:

1. Press **Menu->Features->DSS Keys->Memory Keys** (or **Line Keys**).
2. Select the desired DSS key.
3. Press **◀** or **▶**, or the **Switch** soft key to select **Intercom** from the **Type** field.

- Select the desired line from the **Account ID** field.

The screenshot shows a configuration window titled "DSS Key 1". Inside the window, there is a list of three items:

- 1. Type: Intercom
- 2. Account ID: Line 1
- 3. Value: 2201

The "3. Value" field is highlighted with a black background. To the right of the list is a small icon of a hand with an upward arrow. Below the list are four buttons: "Back", "123", "Del", and "Save".

- Enter the remote extension number in the **Value** field.
- Press the **Save** soft key to accept the change or the **Back** soft key to cancel.

You can also configure an intercom key via web user interface at the path **Phone->DSS Keys**.

#### To place an intercom call:

- Press the intercom key when the phone is idle.  
The phone is automatically connected to the extension specified in the **Value** field.
- Press the intercom key again or the **Cancel** soft key to end the intercom call.

## Incoming Intercom Calls

By default, the SIP-T28P IP phone supports to answer an incoming intercom call automatically. The phone automatically plays a warning tone when it receives an incoming intercom call. In addition, you can enable the phone to mute the microphone when it automatically answers an incoming intercom call. You can also enable the phone to automatically answer an incoming intercom call while there is already an active call on the phone, the active call is placed on hold.

Intercom features you need to know:

Intercom features	Description
Intercom Allow	Allows you to enable or disable the IP phone to automatically answer an incoming intercom call.
Intercom Mute	Allows you to enable or disable the microphone on the IP phone for Intercom calls.
Intercom Tone	Allows you to enable or disable a warning tone when the phone receives an incoming intercom call.
Intercom Barge	Allows you to enable or disable the IP phone to automatically answer an incoming intercom call while there is already an active call on the phone.

**To configure intercom features via phone user interface:**

1. Press **Menu->Features->Intercom**.
2. Make the desired changes.

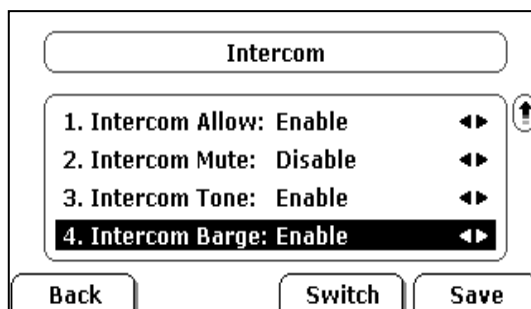

3. Press the **Save** soft key to accept the change or the **Back** soft key to cancel.

You can also configure these specific parameters via web user interface at the path **Phone->Features**.

**Intercom Allow**

You can enable or disable the phone to automatically answer an incoming intercom call. If Intercom Allow is enabled, the phone automatically answers an incoming intercom call. If Intercom Allow is disabled, the phone rejects incoming intercom calls and sends a busy signal to the caller. Intercom Allow is enabled by default.

**Note**

Your administrator can set a time period delay before the phone automatically answers. Contact your system administrator for more information.

**Intercom Mute**

You can mute or un-mute the microphone on the phone for intercom calls automatically. If Intercom Mute is enabled, the microphone is muted for intercom calls. If Intercom Mute is disabled, the microphone is un-muted for incoming calls. Intercom Mute is disabled by default.

**Intercom Tone**

You can enable or disable the phone to play a warning tone when receiving an intercom call. If Intercom Tone is enabled, the phone plays a warning tone to alert you before answering the intercom call. If Intercom Tone is disabled, the phone automatically answers the intercom call without warning. Intercom Tone is enabled by default.

**Intercom Barge**

You can enable or disable the phone to automatically answer an incoming intercom call while there is already an active call on the phone. If Intercom Barge is enabled, the phone automatically answers the intercom call and places the active call on hold. If





Intercom Barge is disabled, the phone handles an incoming intercom call like a waiting call. Intercom Barge is disabled by default.

## Multicast Paging

You can use multicast paging to quickly and easily forward time sensitive announcements out to people within the multicast group. You can configure a multicast paging key on the phone, which allows you to send a Real Time Transport Protocol (RTP) stream to the pre-configured multicast address(es) without involving SIP signaling. You can configure the phone to allow it to receive an RTP stream from pre-configured multicast listening address(es) without involving SIP signaling. You can specify up to 10 multicast listening addresses.

## Sending RTP Stream

To configure a multicast paging key via phone user interface:

1. Press **Menu->Features->DSS Keys->Memory Keys** (or **Line Keys**).
2. Select the desired DSS key.
3. Press  or , or the **Switch** soft key to select **Key Event** from the **Type** field.
4. Press  or , or the **Switch** soft key to select **Multicast paging** from the **Key Type** field.
5. Enter the multicast IP address and port number (e.g. 224.5.6.20:10008) in the **Value** field.

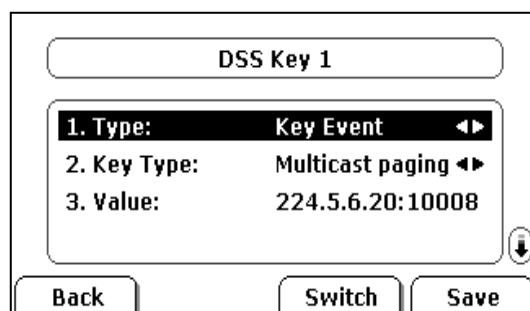

6. Press the **Save** soft key to accept the change or the **Back** soft key to cancel.

You can also configure a multicast paging key via web user interface at the path **Phone->DSS Keys**.

You can also configure the phone to use a default codec for sending Multicast RTP stream via web user interface.

To configure a default codec for multicast paging via web user interface:

1. Click on **Phone->Features**.
2. Select the desired codec from the pull-down list of **MulticastCodec**.

3. Click **Confirm** to accept the change.

**Note**

If G722 codec is used for multicast paging, the phone LCD screen prompts "HD" to indicate that is providing high definition voice.

**To send RTP stream:**

1. Press the multicast paging key when the phone is idle.

The phone sends RTP to a preconfigured multicast address (IP: Port). Any phone in the local network then listens to the RTP on the preconfigured multicast address (IP: Port). For both sending and receiving of the multicast RTP there is no sip signaling involved.

The multicast paging key LED illuminates solid green.

The following figure shows a multicast RTP session on the phone:

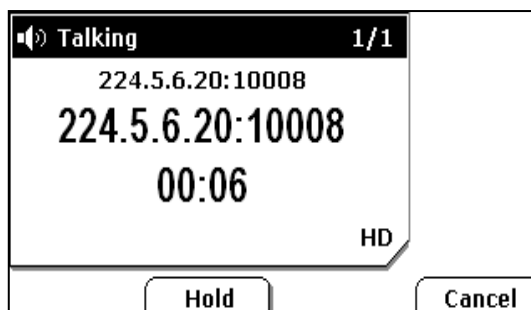

2. Press the **Hold** soft key to place the current multicast RTP session on hold.
3. Press the **Cancel** soft key to cancel the multicast RTP session.

**Note**

Multicast RTP is one way only from sender to the multicast address(es) (receiver). For outgoing RTP multicasts, all other existing calls on the phone will be placed on hold.

## Receiving RTP Stream

You can configure the phone to receive a Real Time Transport Protocol (RTP) stream from the pre-configured multicast address(es) without involving SIP signaling. You can specify up to 10 multicast addresses that the phone listens to on the network.

You can also change the behavior of how the phone handles incoming multicast paging calls by configuring specific parameters via web user interface. The specific parameters are: Paging Barge and Paging Priority Active.

### Paging Barge

You can use the paging barge feature to define the priority of the voice call in progress. If the priority of an incoming multicast paging call is lower than that of the active call, then it will be ignored automatically. If Disabled is selected from the pull-down list of



Paging Barge, the voice call in progress shall take precedence over all incoming multicast paging calls. The valid values in the Paging Barge field are:

- **1 to 10:** Define the priority of the active call, 1 is the highest priority, 10 is the lowest priority.
- **Disabled:** The voice call in progress shall take precedence over all incoming paging calls.

### Paging Priority Active

You can enable or disable this feature to decide how the phone handles the incoming multicast paging calls, when there is already a multicast paging call on the phone. If enabled, the phone will ignore the incoming multicast paging call with a lower priority, otherwise, the phone will play the incoming multicast RTP and place the previous multicast paging call on hold. If disabled, the phone will automatically ignore all incoming multicast paging calls.

**To configure multicast listening addresses via web user interface:**

1. Click on **Contacts->MulticastIP**.
2. Select the desired value from the pull-down list of **Paging Barge**.
3. Select the desired value from the pull-down list of **Paging Priority Active**.
4. Enter the multicast IP address(es) and port number(e.g. 224.5.6.20:10008) which the phone listens for incoming RTP multicast in the **Listening Address** field.
5. Enter the label in the **Label** field. Label will appear on the LCD screen when receiving the RTP multicast.
6. Click **Confirm** to accept the change.

#### Note

The multicast IP addresses range from 224.0.0.0 to 239.255.255.255. The priorities of listening addresses are predefined: 1 with the highest priority, 10 with the lowest priority.

Both the multicast paging sender and the receiver will play a warning tone when pressing the multicast paging key.

## Music on Hold

Music on hold (MOH) is the business practice of playing recorded music to fill the silence that would be heard by the callers who have been placed on hold. To use this feature, you should specify a SIP URI pointing to a Music on Hold Server account, when placing a call on hold, the phone will invite this SIP URI to the Music on Hold Server account. The Music on Hold account automatically answers to the SIP INVITE messages and immediately plays audio from some source located anywhere (LAN, Internet) to the held party. Contact your system administrator for the SIP URI.

**To configure music on hold server via web user interface:**

1. Click on **Account**.
2. Select the desired account from the pull-down list of **Account**.
3. Click on **Advanced**.
4. Enter the SIP URI in the **Music on hold server** field.
5. Click **Confirm** to accept the change.

When you have placed a call on hold, the held party can then hear the music.

**Note**

All involved parties cannot use encrypted RTP (SRTP).

## Automatic Call Distribution (ACD)

ACD feature is often used in offices for customer service, such as call center. The ACD system handles large volumes of incoming calls from callers who have no need to talk to a specific person but who require assistance from any of multiple persons at the earliest opportunity. The ACD feature on the SIP-T28P IP phone allows the ACD system to distribute calls from large volumes of incoming calls to the registered IP phone users. To use this feature, you should configure an ACD key in advance.

**To configure an ACD key via phone user interface:**

1. Press **Menu->Features->DSS Keys->Memory Keys** (or **Line Keys**).
2. Select the desired DSS key.
3. Press  $\leftarrow$  or  $\rightarrow$ , or the **Switch** soft key to select **ACD** from the **Type** field.
4. Press  $\leftarrow$  or  $\rightarrow$ , or the **Switch** soft key to select the desired line from the **Account ID** field.

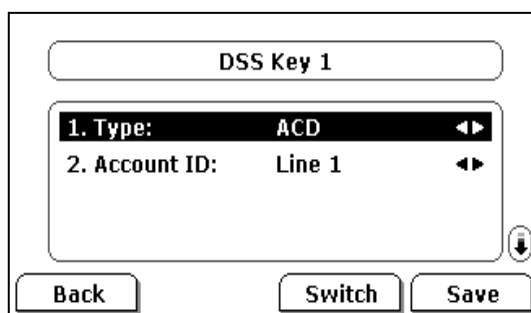

5. Press the **Save** soft key to accept the change or the **Back** soft key to cancel.

You can also configure an ACD key via web user interface at the path **Phone->DSS Keys**.

**To use the ACD feature:**

1. Press the ACD key when the phone is idle.

The phone LCD screen prompts you the following information:

**User ID:** the phone number used to log in the queue.

**Password:** the password used to log in the queue.

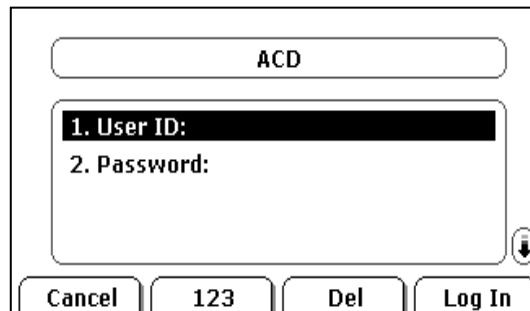

2. Press the **Log In** soft key to log in.

**Note**

Contact your system administrator for the User ID and Password to access the ACD system.

After configuring an ACD key, you can press the ACD key to log in the ACD system. After logging in, you are ready to receive calls from the ACD system. You can press the ACD key to show your current phone status. You can press the **Available/Unavailable** soft key to change your phone status. The system server monitors your phone status. When you set the phone status to available, the ACD key LED illuminates solid green, and then the server begins distributing calls to your phone. When you set the phone to unavailable, the ACD key LED illuminates flashing green, and then the server temporarily stops distributing calls to your phone. To log out the ACD system, press the **Log Out** soft key.

**Note**

It is recommended you configure no more than one ACD key per phone. At any time, at most one ACD key can be in progress on your phone.

## Messages

### Short Message Service (SMS)

You can send and receive text messages using the SIP-T28P IP phone. New text messages can be indicated both acoustically and visually. When receiving a new text message, the phone will play a warning tone, the phone LCD screen will prompt receiving new text messages with the number of waiting messages (example: 5 New Text Message) and a flashing icon.



#### Note

The SMS feature is not available on all servers. Contact your system administrator for more information.

To read a text message:

1. Press **Menu->Messages->Text Message->Inbox**.

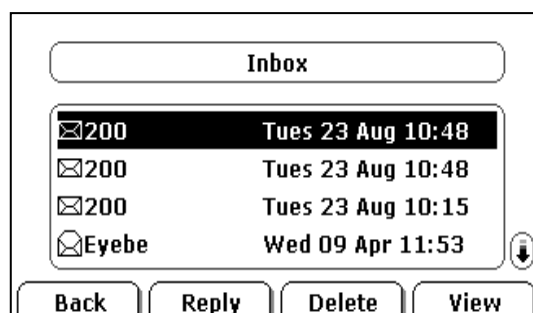

2. Select the desired message and press the **View** soft key.

#### Note

If the phone prompts receiving new text messages, you can also press the **View** soft key to read the new messages directly.

To send a text message:

1. Press **Menu->Messages->Text Message->New Message**.
2. Compose the new text message. You can press the **abc** soft key to change the input

mode.

3. Press the **Send** soft key.
4. (Optional.) Press ◀ or ▶ , or the **Switch** soft key to select the desired account from the **From** field.
5. Enter the number you want to send the message to in the **To** field.
6. Press the **Send** soft key to send the message or the **Back** soft key to cancel.

You can also send a text message via web user interface at the path **Phone->SMS**.

#### To reply a text message:

1. Press **Menu->Messages->Text Message->Inbox**.
2. Select the desired message and press the **Reply** soft key.
3. Compose the new text message. You can press the **abc** soft key to change the input mode.

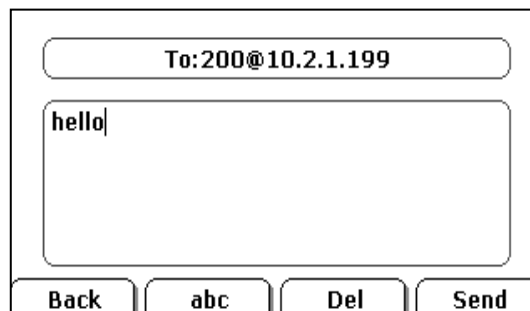

4. Press the **Send** soft key after completing the content.

#### To delete a text message:

1. Press **Menu->Messages->Text Message->Inbox (Sentbox, Outbox or Draftbox)**.
2. Select the desired message and then press the **Delete** soft key.

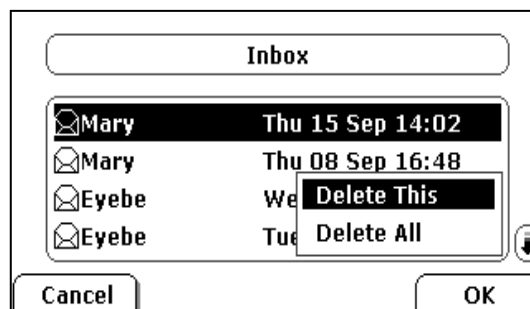

3. Select **Delete This** to delete the desired message.

The LCD screen prompts "Delete Message?".

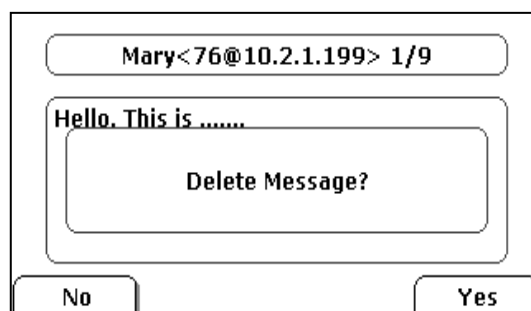

4. Press the **Yes** soft key to delete this message or the **No** soft key to cancel.

**Note**

You can also delete all text messages by pressing the **Delete** soft key and then select **Delete All**. You can refer to the above steps.

You can also delete a specific message after retrieving by pressing the **Delete** soft key.

## Voice Mail

You can leave voice mails for someone else on the SIP-T28P IP phone. You can also listen to the voice mails stored in a centralized location. When receiving a new voice mail, the phone will play a warning tone and the MESSAGE key LED will illuminate. The phone LCD screen will prompt receiving a new voice mail and a flashing icon.

**Note**

Voice Mail feature is not available on all servers, contact your system administrator for more information.

**To leave a voice mail:**

You can leave a voice mail for someone else when he/she is busy or inconvenient to answer the call. Follow the voice prompt from the system server to leave the voice mail, and then hang up after completing the voice mail.

To configure voice mail access codes via phone user interface:

1. Press **Menu->Messages->Voice Mail->Set Voice Mail**.

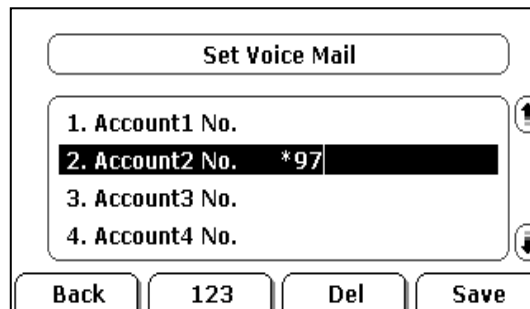

2. Press the navigation keys to highlight the account which you want to set.
3. Press the **123** soft key to select the proper input mode and then enter the voice mail access code (e.g. \*97).
4. Press the **Save** soft key to accept the change or the **Back** soft key to cancel.

**Note**

Voice mail access code must be predefined on the system server. Contact your system administrator for the more information.

To listen to the voice mails:

1. When the phone user interface prompts receiving new voice mails, press  or the **Connect** soft key to dial out the access voice mail code.
2. Follow the voice prompt to listen to the voice mails.

**Note**

Before listening to the voice mails, make sure the voice mail access code has been configured.

When all new voice mails are retrieved, the MESSAGE key LED will turn off.

To view the voice mail via phone user interface:

1. Press **Menu->Messages->Voice Mail->View Voice Mail**.

The phone LCD screen displays the amount of the voice mails that includes new or old voice mails.

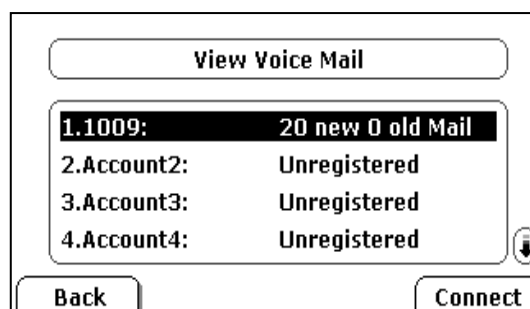

2. Select an account and then press the **Connect** soft key to listen to the voice mails.

## Message Waiting Indicator (MWI)

The SIP-T28P IP phone supports MWI feature when receiving a new voice message. If someone leaves you a voicemail, you will receive a message waiting indicator. MWI will be indicated in three ways: a warning tone, the MESSAGE key LED illuminates solid green and an indicator message (including a voice mail icon) appears on the LCD screen. This is cleared only when you retrieve all voice mails or delete them.

For some particular servers, the MWI service is unsolicited. So the SIP-T28P IP phone just need to handle the MWI messages sent from the server. But for some servers, the MWI service is solicited. In this case, the SIP-T28P IP phone must enable the MWI Subscription for MWI messages.

### Note

MWI service is not available on all servers. Contact your system administrator for more information.

The MWI Subscription parameters you need to know:

Options	Description
<b>Subscribe for MWI</b>	Enable or disable a subscription for MWI service.
<b>MWI Subscription Period</b>	Period of MWI subscription. The IP phone re-sends a MWI subscription before expiring.

**To enable MWI subscription via web user interface:**

1. Click on **Account->Advanced**.
2. Select **Enabled** from the pull-down list of **Subscribe for MWI**.
3. Enter the period time (in seconds) in the **MWI Subscription Period** field.
4. Click **Confirm** to accept the change.



# Troubleshooting

---

This chapter provides general troubleshooting information to help you solve the problems you might encounter when using your SIP-T28P IP phone.

If you require additional information or assistance with your new phone, contact your system administrator.

## Why is the phone LCD screen blank?

- Ensure your phone is properly plugged into a functional AC outlet.
- Ensure that the phone isn't plugged into a plug controlled by a switch that is off.
- If the phone is plugged into a power strip, try plugging it directly into a wall outlet instead.
- If your phone is powered from PoE, ensure you use a PoE compliant switch or hub, or contact your system administrator for more information.
- Check that the power LED is on to ensure the phone is powered on.

## Why does the LCD screen have bad contrast?

You need to adjust the contrast of LCD screen. To adjust the contrast, refer to [Contrast](#) on page 19.

## Why does the phone display "Network Unavailable"?

- Ensure that the Ethernet cable is plugged into the Internet port of the phone and the Ethernet cable is not loose.
- Ensure that the switch or hub in your network is operational.
- Contact your system administrator for more information.

## Why does the phone display "No Service"?

The phone LCD screen prompts "No Service" message when the SIP accounts do not register successfully. Contact your system administrator for more information on account settings.

## Why can't I get a dial tone?

Check for any loose connections and that the phone has been installed properly. For the installation instructions, refer to [Phone Installation](#) on page 13.

Check whether dial tone is present on one of the audio modes.

- Switch between the Handset, Headset (if present) or Hands-Free Speakerphone to check whether dial tone is present for one of the audio modes.

- If the dial tone exists on another audio mode, connect a different handset or headset to isolate the problem.

#### **Why doesn't the phone ring?**

Check the ringer volume on your phone. To adjust the ringer volume setting, press the Volume key when the phone is on-hook and idle. For more information, refer to [Volume](#) on page 26.

#### **Why can't I receive calls?**

- Check the SIP registration with your system administrator.
- Check DND (Do Not Disturb) mode is turned off on your phone. Refer to [Do Not Disturb \(DND\)](#) on page 55.
- Check call forward feature is disabled on the phone. Refer to [Call Forward](#) on page 55.
- Check whether the caller number is stored in the blacklist directory. Refer to [Blacklist](#) on page 32.

#### **Why is my handset not working?**

Check to ensure that the handset cord is fully connected to both the handset jack on the phone and handset. Refer to [Phone Installation](#) on page 13.

#### **Why is my headset not working?**

- Check to ensure that the headset cord is fully connected to the headset jack on the phone. Refer to [Phone Installation](#) on page 13.
- Check to ensure that the headset mode is activated. Refer to [Headset Activation/Deactivation](#) on page 35.
- Check to ensure that the headset volume is adjusted to an appropriate level. Refer to [Volume](#) on page 26.

#### **How to change the user password?**

You can change the user password via web user interface:

1. Click on **Security->Password**.
2. Enter the current user password in the **Current Password** field.
3. Enter the new user password in the **New Password** field and **Confirm Password** field.
4. Click **Confirm** to accept the change.

You can also contact your system administrator for help.

### How to reboot the phone?

To reboot the IP phone via web user interface:

1. Click on **Upgrade->Basic**.
2. Click **Reboot** to reboot the IP phone.



#### Note

Any reboot of your phone may take a few minutes.

### How to reset your phone?

Reset your phone when other Troubleshooting suggestions do not correct the problem. You need to note that all customized settings will be overwritten after resetting. We recommend asking your system administrator for advice before resetting your phone.

To reset your phone via phone user interface:

1. Press **Menu->Settings->Advanced Settings** (password: admin).
2. Press  or  to scroll to **Reset to factory**, and then press the **Enter** soft key.

The LCD screen prompts the following message:

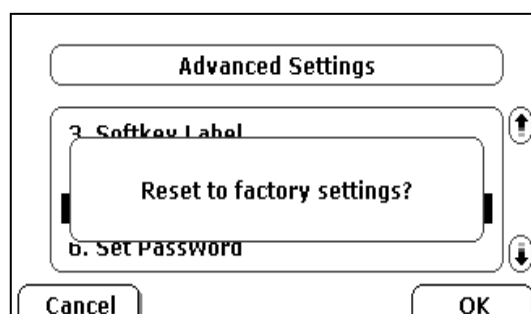

3. Press the **OK** soft key.

#### Note

Reset of your phone may take a few minutes.

### How to Export PCAP Trace?

We may need you to provide a PCAP Trace to help analyze your problem.

To export a PCAP Trace via web user interface:

1. Click on **Upgrade->Advanced**.
2. Click **Start** to begin recording signal traffic.
3. Recreate the error to be documented in the trace.
4. Click **Stop** to end recording.
5. Click **Export** to open file download window, and then save the file to your local system.

### How to Export System Log?

We may need you to provide a System Log to help analyze your problem.

#### To export a System Log via web user interface:

1. Click on **Upgrade->Advanced**.
2. Select **Local** from the pull-down list of **Export System Log**.
3. Click **Export** to open file download window, and then save the file to your local system.

You can also export the system log to a Syslog Server, contact your system administrator for more information.

### How to Export/ Import phone Configurations?

We may need you to provide your phone configurations to help analyze your problem. In some instance, you may need to import configurations to your phone.

#### To export your phone configurations via web user interface:

1. Click on **Upgrade->Advanced**.
2. Click **Export** to open file download window, and then save the file to your local system.

#### To Import phone configurations via web user interface:

1. Click on **Upgrade->Advanced**.
2. Click **Browse** to select a configuration file from your local system.
3. Click **Import** to import the configuration file.

#### Note

The file format of configuration file must be “.bin”.

# Regulatory Notices

## Service Agreements

Contact your Yealink Authorized Reseller for information about service agreements applicable to your product.

## Limitations of Liability

TO THE FULL EXTENT ALLOWED BY LAW, YEALINK EXCLUDES FOR ITSELF AND ITS SUPPLIERS ANY LIABILITY, WHETHER BASED IN CONTRACT OR TORT (INCLUDING NEGLIGENCE), FOR INCIDENTAL, CONSEQUENTIAL, INDIRECT, SPECIAL, OR PUNITIVE DAMAGES OF ANY KIND, OR FOR LOSS OF REVENUE OR PROFITS, LOSS OF BUSINESS, LOSS OF INFORMATION OR DATA, OR OTHER FINANCIAL LOSS ARISING OUT OF OR IN CONNECTION WITH THE SALE, INSTALLATION, MAINTENANCE, USE, PERFORMANCE, FAILURE, OR INTERRUPTION OF ITS PRODUCTS, EVEN IF YEALINK OR ITS AUTHORIZED RESELLER HAS BEEN ADVISED OF THE POSSIBILITY OF SUCH DAMAGES, AND LIMITS ITS LIABILITY TO REPAIR, REPLACEMENT, OR REFUND OF THE PURCHASE PRICE PAID, AT YEALINK'S OPTION. THIS DISCLAIMER OF LIABILITY FOR DAMAGES WILL NOT BE AFFECTED IF ANY REMEDY PROVIDED HEREIN SHALL FAIL OF ITS ESSENTIAL PURPOSE.

## Safety Instructions

**Save these instructions. Read these safety instructions before use!**

The following basic safety precautions should always be followed to reduce risk of fire, electrical shock, and other personal injury.

### General Requirements

- Before you install and use the device, read the safety instructions carefully and observe the situation during operation.
- During the process of storage, transportation, and operation, please always keep the device dry and clean.
- During the process of storage, transportation, and operation, please avoid collision and crash of the device.
- Please attempt not to dismantle the device by yourself. In case of any discrepancy, please contact the appointed maintenance center for repair.
- Without prior written consent, no organization or individual is permitted to make any change to the structure or the safety design of the device. Yealink is under no circumstance liable to consequences or legal issues caused by such changes.
- Please refer to the relevant laws and statutes while using the device. Legal rights of others should be respected as well.

### Environmental Requirements

- Place the device at a well-ventilated place. Do not expose the device under direct sunlight.
- Keep the device dry and free of dusts.

- Place the device on a stable and level platform.
- Please place no heavy objects on the device in case of damage and deformation caused by the heavy load.
- Keep at least 10 cm between the device and the closest object for heat dissipation.
- Do not place the device on or near any inflammable or fire-vulnerable object, such as rubber-made materials.
- Keep the device away from any heat source or bare fire, such as a candle or an electric heater.
- Keep the device away from any household appliance with strong magnetic field or electromagnetic field, such as a microwave oven or a refrigerator.

### **Operating Requirements**

- Do not let a child operate the device without guidance.
- Do not let a child play with the device or any accessory in case of accidental swallowing.
- Please use the accessories provided or authorized by the manufacturer only.
- The power supply of the device shall meet the requirements of the input voltage of the device. Please use the provided surge protection power socket only.
- Before plugging or unplugging any cable, make sure that your hands are completely dry.
- Do not spill liquid of any kind on the product or use the equipment near water, for example, near a bathtub, washbowl, kitchen sink, wet basement or near a swimming pool.
- Do not tread on, pull, or over-bend any cable in case of malfunction of the device.
- During a thunderstorm, stop using the device and disconnect it from the power supply. Unplug the power plug and the Asymmetric Digital Subscriber Line (ADSL) twisted pair (the radio frequency cable) to avoid lightning strike.
- If the device is left unused for a rather long time, disconnect it from the power supply and unplug the power plug.
- When there is smoke emitted from the device, or some abnormal noise or smell, disconnect the device from the power supply, and unplug the power plug immediately. Contact the specified maintenance center for repair.
- Do not insert any object into equipment slots that is not part of the product or auxiliary product.
- Before connecting a cable, connect the grounding cable of the device first. Do not disconnect the grounding cable until you disconnect all other cables.

### **Cleaning Requirements**

- Before cleaning the device, stop using it and disconnect it from the power supply.
- Use a piece of soft, dry and anti-static cloth to clean the device.
- Keep the power plug clean and dry. Using a dirty or wet power plug may lead to electric shock or other perils.

## Appendix A - Time Zones

Time Zone	Time Zone Name
- 11:00	Samoa
- 10:00	United States-Hawaii-Aleutian
- 10:00	United States-Alaska-Aleutian
- 09:00	United States-Alaska Time
- 08:00	Canada(Vancouver, Whitehorse)
- 08:00	Mexico(Tijuana, Mexicali)
- 08:00	United States-Pacific Time
- 07:00	Canada(Edmonton, Calgary)
- 07:00	Mexico(Mazatlan, Chihuahua)
- 07:00	United States-Mountain Time
- 07:00	United States-MST no DST
- 06:00	Canada-Manitoba(Winnipeg)
- 06:00	Chile(Easter Islands)
- 06:00	Mexico(Mexico City, Acapulco)
- 06:00	United States-Central Time
- 05:00	Bahamas(Nassau)
- 05:00	Canada(Montreal, Ottawa, Quebec)
- 05:00	Cuba(Havana)
- 05:00	United States-Eastern Time
- 04:30	Venezuela(Caracas)
- 04:00	Canada(Halifax, Saint John)
- 04:00	Chile(Santiago)
- 04:00	Paraguay(Asuncion)
- 04:00	United Kingdom-Bermuda(Bermuda)
- 04:00	United Kingdom(Falkland Islands)
- 04:00	Trinidad&Tobago
- 03:30	Canada- New Foundland(St.Johns)
- 03:00	Denmark-Greenland(Nuuk)
- 03:00	Argentina(Buenos Aires)
- 03:00	Brazil(no DST)
- 03:00	Brazil(DST)
- 02:00	Brazil(no DST)
- 01:00	Portugal(Azores)
0	GMT
0	Greenland
0	Denmark-Faroe Islands(Torshaven)
0	Ireland(Dublin)
0	Portugal(Lisboa, Porto, Funchal)
0	Spain-Canary Islands(Las Palmas)
0	United Kingdom(London)
0	Morocco
+ 01:00	Albania(Tirana)
+ 01:00	Austria(Vienna)
+ 01:00	Belgium(Brussels)
+ 01:00	Caicos
+ 01:00	Chatam
+ 01:00	Croatia(Zagreb)
+ 01:00	Czech Republic(Prague)
+ 01:00	Denmark(Copenhagen)
+ 01:00	France(Paris)
+ 01:00	Germany(Berlin)

Time Zone	Time Zone Name
+01:00	Hungary(Budapest)
+01:00	Italy(Rome)
+01:00	Luxembourg(Luxembourg)
+01:00	Macedonia(Skopje)
+01:00	Netherlands(Amsterdam)
+01:00	Namibia(Windhoek)
+02:00	Estonia(Tallinn)
+02:00	Finland(Helsinki)
+02:00	Gaza Strip(Gaza)
+02:00	Greece(Athens)
+02:00	Israel(Tel Aviv)
+02:00	Jordan(Amman)
+02:00	Latvia(Riga)
+02:00	Lebanon(Beirut)
+02:00	Moldova(Kishinev)
+02:00	Russia(Kaliningrad)
+02:00	Romania(Bucharest)
+02:00	Syria(Damascus)
+02:00	Turkey(Ankara)
+02:00	Ukraine(Kyiv, Odessa)
+02:00	Syria(Damascus)
+03:00	East Africa Time
+03:00	Iraq(Baghdad)
+03:00	Russia(Moscow)
+03:30	Iran(Teheran)
+04:00	Armenia(Yerevan)
+04:00	Azerbaijan(Baku)
+04:00	Georgia(Tbilisi)
+04:00	Kazakstan(Aqtau)
+04:00	Russia(Samara)
+05:00	Kazakstan(Aqtobe)
+05:00	Kyrgyzstan(Bishkek)
+05:00	Pakistan(Islamabad)
+05:00	Russia(Chelyabinsk)
+05:30	India(Calcutta)
+06:00	Kazakhstan(Astana, Almaty)
+06:00	Russia(Novosibirsk, Omsk)
+07:00	Russia(Krasnoyarsk)
+07:00	Thailand(Bangkok)
+08:00	China(Beijing)
+08:00	Singapore(Singapore)
+08:00	Australia(Perth)
+09:00	Korea(Seoul)
+09:00	Japan(Tokyo)
+09:30	Australia(Adelaide)
+09:30	Australia(Darwin)
+10:00	Australia(Sydney, Melbourne, Canberra)
+10:00	Australia(Brisbane)
+10:00	Australia(Hobart)
+10:00	Russia(Vladivostok)
+10:30	Australia(Lord Howe Islands)
+11:00	New Caledonia(Noumea)
+12:00	New Zeland(Wellington, Auckland)
+12:45	New Zeland(Chatham Islands)
+13:00	Tonga(Nukualofa)



# Index

## A

About This Guide [v](#)  
 Account Registration [41](#)  
 Account Management [41](#)  
 Adding Contacts [28](#)  
 Anonymous Call [64](#)  
 Anonymous Call Rejection [65](#)  
 Answering Calls [51](#)  
 Area Code [45](#)  
 Attaching Stand [13](#)  
 Automatic Call Distribution (ACD) [80](#)  
 Audio Settings [26](#)

## B

Backlight [20](#)  
 Basic Network Settings [16](#)  
 Blacklist [32](#)  
 BLF list [68](#)  
 Block Out [45](#)  
 Busy Lamp Field (BLF) [67](#)

## C

CE Mark Warning [vi](#)  
 Call History Management [33](#)  
 Call Forward [55](#)  
 Call Mute [53](#)  
 Call Hold/Resume [54](#)  
 Call Recording [71](#)  
 Conference [59](#)  
 Contrast [19](#)  
 Copyright [vi](#)  
 Customizing Your Phone [19](#)  
 Contact Management [27](#)  
 Call Park [61](#)  
 Call Pickup [62](#)  
 Call Return [53](#)  
 Call Transfer [58](#)

## D

Declaration of Conformity [vi](#)  
 Deleting Contacts [30](#)  
 Dial-now [44](#)  
 Dial Plan [43](#)  
 Documentation [9](#)  
 Do Not Disturb (DND) [55](#)  
 DSS Keys [36](#)  
 Dual Headset [36](#)

## E

Editing Contacts [29](#)  
 Emergency Number [46](#)  
 Ending Calls [52](#)

## G

Getting Started [11](#)  
 General Settings [19](#)

## H

Hardware Component Instructions [1](#)  
 Headset Use [35](#)  
 Headset Activation/Deactivation [35](#)  
 Headset Prior [35](#)  
 Hot Desking [73](#)  
 Hot Line [47](#)

## I

Icon Instructions [3](#)  
 Idle screen [17](#)  
 Importing/Exporting Contact lists [31](#)  
 Incoming intercom call features [75](#)  
 Intercom [74](#)  
 In This Guide [v](#)

## K

Key as Send [24](#)  
 Keypad Lock [24](#)

## L

Language [21](#)  
 LED Instructions [5](#)  
 Limitation of Liability [91](#)  
 Line Keys [40](#)  
 Live Dialpad [46](#)  
 Local Conference [59](#)  
 Local Directory [28](#)  
 Logo Customization [35](#)

## M

Memory Keys [36](#)  
 Messages [82](#)  
 Message Waiting Indicator [86](#)  
 Multiple Line Keys per Account [42](#)  
 Music on Hold [79](#)  
 Multicast Paging [77](#)

## N

Network Conference [60](#)  
 Network Connection [13](#)  
 No answer Forward [55](#)

## P

Packing List [11](#)  
 Phone Installation [13](#)  
 Phone Initialization [15](#)  
 Phone Status [16](#)

Phone User Interface	6
Placing Calls to Contacts	30
Placing Calls	49
Programmable Keys	41

## O

Overview	1
Outgoing intercom Calls	74

## R

Registration	17
Redialing Numbers	53
Regulatory Notices	91
Remote Phonebook	32
Replace Rule	43
Ring Tones	26
Receiving RTP Stream	78

## S

Searching for Contacts	31
Safety Instructions	91
Semi-attended Transfer	58
Sending RTP Stream	77
Service Agreements	91
Shared Lines	69
Short Message Service(SMS)	82
System Customizations	35

## T

Time and Date	21
Time Zones	93
Troubleshooting	87

## V

Voice Mail	84
Volume	26

## W

Warranty	vi
WEEE Warning	vii
Web User Interface	7