



User Manual

snom[®] VISION

TABLE OF CONTENTS

Copyright, Trademarks, GPL, Legal Disclaimers	3
Important information	4
Safety instructions	4
SELV (Safety Extra Low Voltage) compliance	4
Standards conformance	4
Product specifications	5
Disposal of the device	5
Cleaning	5
Setting up the snom Vision	6
Delivery Content	6
Attaching and detaching the footstand	6
Connecting.....	6
Initializing	8
Pairing	8
Configuring the snom Vision.....	10
How the web interface works	10
Configuring the function keys	11
Context	12
Type	12
Number (Value).....	12
Short Text (Name).....	12
Image	12
Settings examples	13
Using the snom Vision	15
The display screens.....	15
Using the function keys.....	16
Appendix 1 - Key events	17
Appendix 2 - Initializing without DHCP	18
Appendix 3 - GNU General Public License.....	19

Copyright, Trademarks, GPL, Legal Disclaimers

© 2012 snom technology Aktiengesellschaft

All Rights Reserved.

snom, the names of snom products, and snom logos are trademarks owned by snom technology AG. All other product names and names of enterprises are the property of their respective owners.

Product specifications are subject to change without notice.

snom technology AG reserves the right to revise and change this document at any time, without being obliged to announce such revisions or changes beforehand or after the fact.

Texts, images, and illustrations and their arrangement in this document are subject to the protection of copyrights and other legal rights worldwide. Their use, reproduction, and transmittal to third parties without express written permission may result in legal proceedings in the criminal courts as well as civil courts.

When this document is made available on snom's web page, snom technology AG gives its permission to download and print copies of its content for the intended purpose of using it as a manual. No parts of this document may be altered, modified or used for commercial purposes without the express written consent of snom technology AG.

Although due care has been taken in the compilation and presentation of the information in this document, the data upon which it is based may have changed in the meantime. snom therefore disclaims all warranties and liability for the accurateness, completeness, and currentness of the information published, except in the case of intention or gross negligence on the part of snom or where liability arises due to binding legal provisions.

Our firmware includes some source code that may be used and modified by anyone and everyone under the GNU Public License (GPL) (enclosed at Appendix 5), provided they, in turn, make it available to everyone else with the same licensing agreement. Please go to <http://www.snom.com/en/support/download/gpl-quellcode/> for the original GPL license and the source code of components licensed under GPL and used in snom products.

Important information

Please read the instructions on safety and disposal and on how to set up and use the device before using it and also give them to other users to read or inform those users of their contents. Save this manual and do not give the device to third parties without it.

Safety instructions

Follow the instructions in this manual and other applicable documentation of the device.

- If the device is not supplied with power via an Ethernet cable, use only a power adapter expressly recommended by snom technology. Other power supplies may damage or destroy the device, affect its behavior, or induce noise.
- Avoid placing the cables where people may trip over them or where they may be exposed to mechanical pressure as this may damage them.
- This device is for indoor use only! NOT FOR OUTDOOR USE!
- Do not install the device in rooms with high humidity (for example, in bathrooms, laundry rooms, damp basements). Do not immerse the device in water and do not spill or pour liquids of any kind onto or into the device.
- Do not install the device in surroundings at risk for explosions (paint shops, for example). Do not use the device if you smell gas or other potentially explosive fumes.
- Do not use the device during thunderstorms. Lightning striking the power grid may cause electric shocks.

SELV (Safety Extra Low Voltage) compliance

Safety status of Input/Output connections comply with SELV requirements.

Warning: To avoid electric shock, do not connect safety extra-low voltage (SELV) circuits to telephone-network voltage (TNV) circuits. LAN ports contain SELV circuits, and PSTN ports contain TNV circuits. Some LAN and PSTN ports both use RJ-45 (8P8C) connectors. Use caution when connecting cables.

Standards conformance



This device is CE and FCC-certified and meets European and US health, safety, and environmental standards.



Unauthorized opening, changing, or modifying the device will cause the warranty to lapse and may also result in the lapse of the CE and FCC certifications. In case of malfunction contact authorized service personnel, your seller, or snom.

Product specifications

- **Safety:** IEC 60950-1:2005
- **Certifications:** FCC Class B, CE Mark
- **Power consumption:** 2.5 - 2.9 watts (without USB peripherals)
- **Power:** 5 V DC
- **Ethernet:** 10/100 Mbps
- **Power** over Ethernet: IEEE 802.3af, Class 2
- **Connectors:**
 - 1 x LAN: RJ45 (Ethernet)
 - USB: 2 x type A, 1 x type B

Disposal of the device



This device is subject to European Directive 2002/96/EC and may not be disposed of with general household garbage.

If you do not know where you may dispose of the device at the end of its lifespan, contact your municipality, your local waste management provider, or your seller.

Cleaning

To clean the device, use an anti-static cloth. Please avoid cleaning liquids as they might damage the surface or internal electronics of the device.

Setting up the snom Vision

Delivery Content

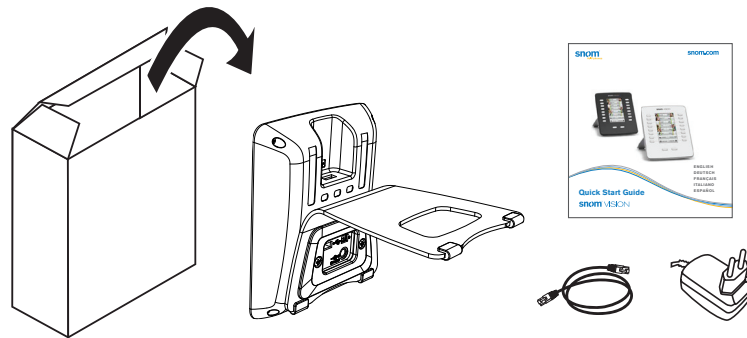

- snom Vision
- Footstand (attached to snom Vision)
- Power adapter
- Ethernet cable
- Quick Start Guide

Attaching and detaching the footstand

The footstand can be attached at two different angles: 55° and 33°. The snom Vision is delivered with the footstand attached at the 55° angle.

- To detach the footstand, unscrew the two screws holding it in place.
- Attach the footstand with the bracket and the 2 screws.

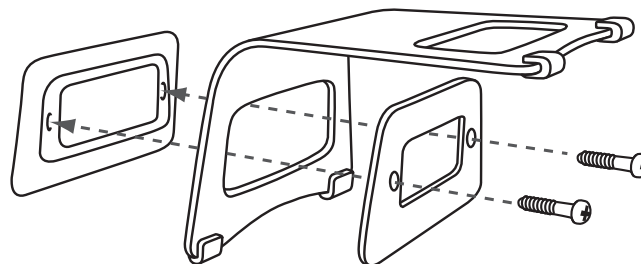

Connecting

The snom Vision can be operated with Power over Ethernet (PoE) provided via the network cable or, if PoE is not available in your network, with the 5V DC power adapter.

- Plug the Ethernet (network) cable into the RJ45 connector labeled "NET", and plug the other end into the network side to establish a data link.

- If PoE is not available, insert the plug of the power supply into the connector labeled "DC 5V", and hook up the plug to the wall outlet.

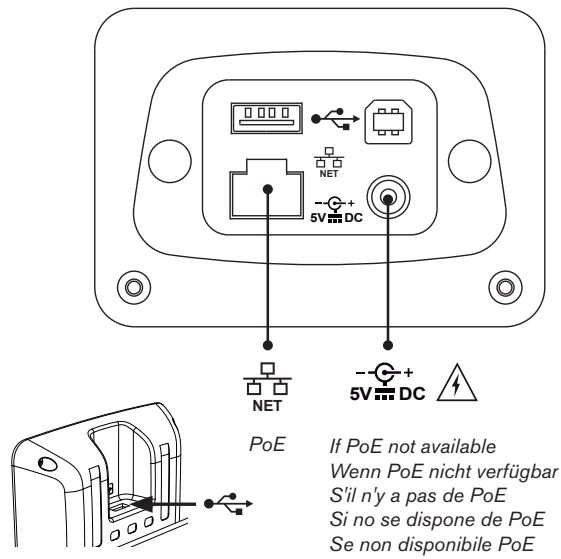

Initializing

Normally the network initialization is completely automatic, using DHCP. If your network does not support DHCP, see "Appendix 2 - Initializing without DHCP" on page 18 for the instructions on entering the necessary network data manually. After the device has been added to the network, you will see a screen similar to this one:

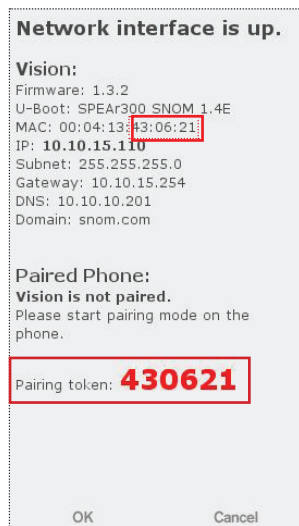

Before you can use the snom Vision, it must be paired with your snom phone. The pairing is initiated from the phone's Settings menu.

Note: The phone must be running firmware version 8.7.4 or higher.

Phones with a lower firmware version can only be used with snom Visions running firmware version 1.2. In that case, the two devices are connected from the web interface of the snom Vision by entering the phone's IP address and, if applicable, HTTP user name and password.

Pairing

Open the Settings menu of the phone. Select 5 Maintenance and then 6 Vision.

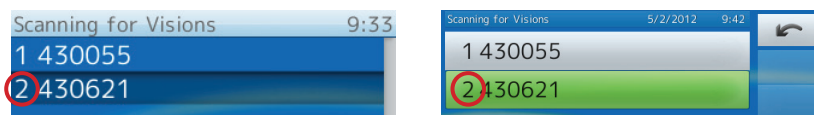

The screen "Scanning for Visions" contains the list of unpaired snom Visions available in your network, represented by their respective pairing tokens, which are the last six digits of the MAC address. Select yours by pressing its number on the alphanumeric keypad. In our example, press 2.

After successful pairing, the display of the snom Vision will show Page 1 of the three function key screens. The factory settings of all function keys is "Speed dial", with the exception of the low bottom keys on Page 1 which are mapped with the function "Application" and the values "Info", and "Photo album", respectively.



Configuring the snom Vision

For general information on function keys on snom phones and on the available functionalities, please see the manual of your phone, chapter "Configuring the Function Keys".

The configuration of the snom Vision is done on its web interface. To open it, type the device's IP address (for example, http://10.10.15.110) into the address bar of your PC's web browser and press ENTER.

Note: To find the IP address, tap the "Info" touch screen button or press the hard key to the left of it. If none of the function keys is mapped with the "Info" function or if the "Info" key is not on the visible screen, press the left arrow key for three (3) seconds to open the info screen.

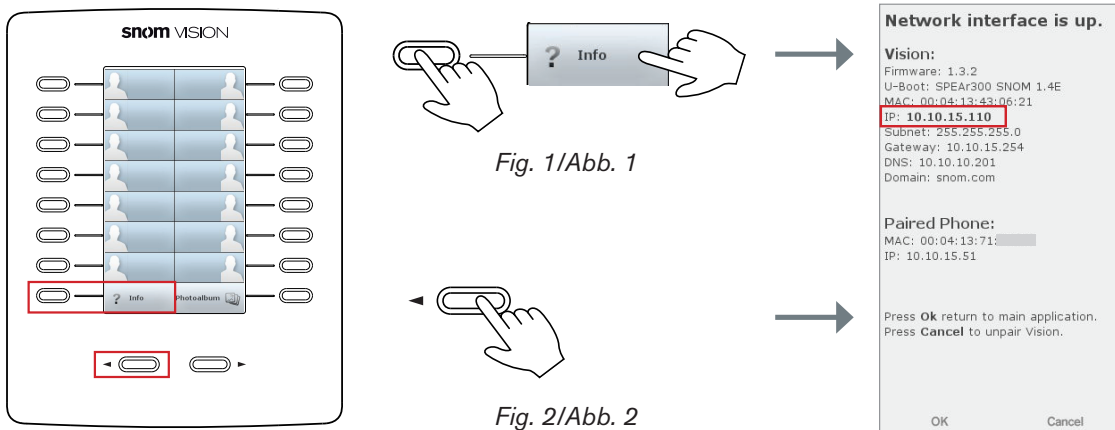

How the web interface works

The vertical menu on the left side of the window is always the same, no matter which window happens to be open at the time.

Click on a menu item to open that page.

Note: Changes are automatically saved to the flash memory every few seconds. If you want to save your entries immediately, click on "Save current settings".

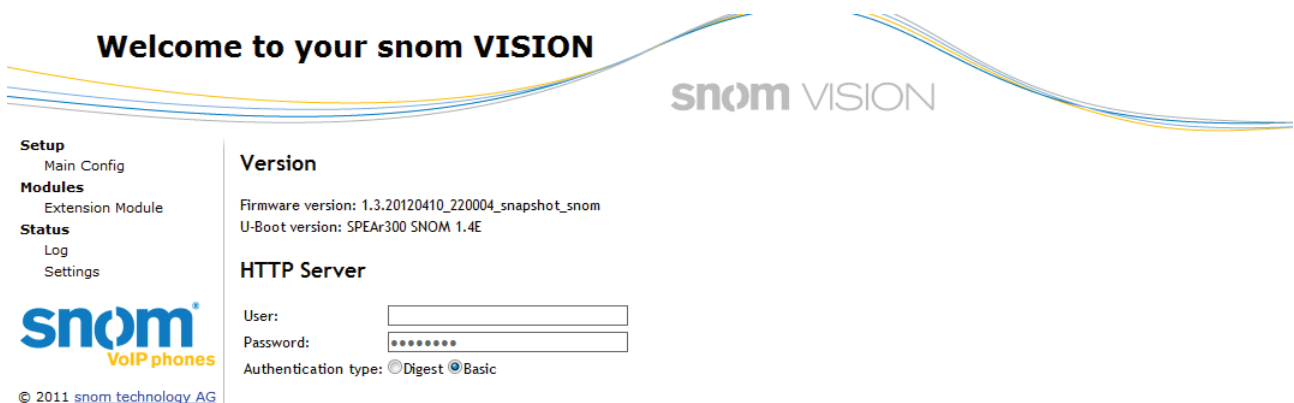

Configuring the function keys

Click on "Extension Module"/"Function Keys" in the menu on the left side to open the function keys page.



The snom Vision has 48 freely programmable function keys with LEDs on three display screens or "pages" that you can select from the drop-down menu.

Button configuration



Each function key consists of a touch screen area on the display and a hardkey with LED; their arrangement corresponds to that on the Function Keys page of the snom Vision's web interface.

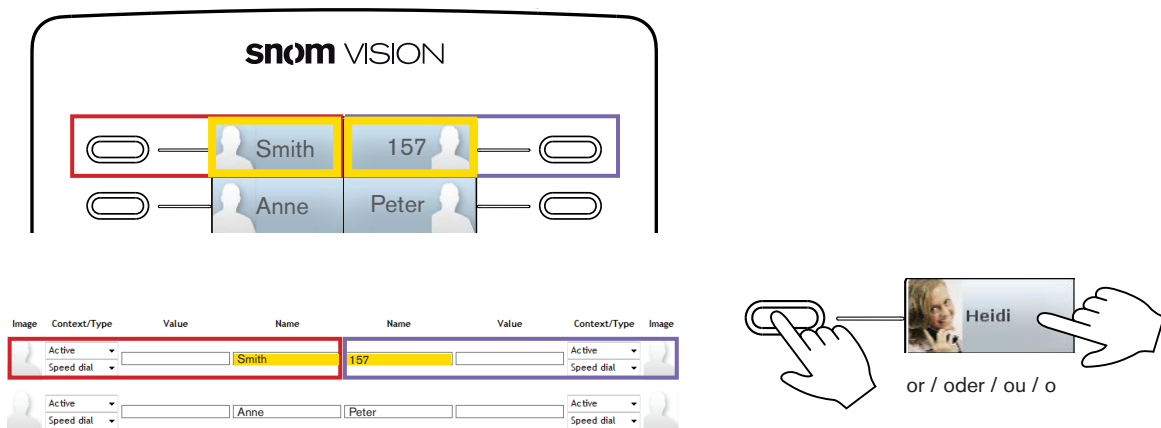

All available functionalities, including key events, can be programmed onto them. Please refer to your phone's user manual for more information on the available functions.

There is one snom Vision-specific function called "Trigger URL" that is currently not available on the phones. This function triggers an URL without any content being shown on the Vision's or the phone's

display; typical uses would be operating a door opener or turning an electric device on and off.

Context

This setting specifies which of the identities configured on the phone will be used when executing the functionality of the key. You may want to use this feature when you have accounts with different providers or when you wish to present different identities to certain destinations.

For example: If you have programmed the top right key to speed dial a specific number and you want to use configured identity 2 to call that number, select configured identity 2 from the drop-down menu of the key's "Context". When you speed dial the number by pressing the hard key or tapping the key's touch screen area, identity 2 will be used as the outgoing identity.

The default setting is "Active", which means that the identity selected as the phone's outgoing identity at any given time will be used.

Type

Select the type of functionality from the drop-down list. The default setting is "Speed dial".

Number (Value)

Enter one phone number or value for the function. Enter phone numbers exactly the way they need to be dialed, i.e. type the number without spaces or punctuation marks between the digits. For example, a number with an area code that might conventionally be notated as (916) 555-1234 should be entered as 9165551234.

If you have selected "Key Event" in the drop-down menu of Context/Type, please look up the syntax for the entry in the table attached at "Appendix 1 - Key events" on page 17.

Short Text (Name)

This is the text that is shown in the touch screen area of the function key. It can be used to show the phone or extension number, the name associated with the phone number, or any other descriptive text.

NOTE: If you leave this text field blank, the display button will show no name or number or other text. This is different from the virtual function keys of the phones, where the entry in the "Number"/"Value" text field is shown on the display when there is no entry in the "Short Text"/"Name" text field.

Image

1. Click on the image area to open the window for uploading an image file or deleting the current image.

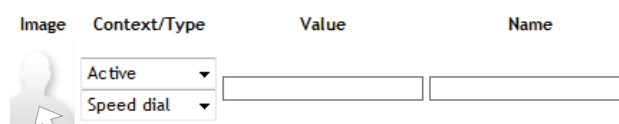



2. Enter the URL of the image file in the text field or click on "Browse" and select an image from your files.



3. Click on "Upload".

Settings examples

Here are some examples of settings and what they look like on the display of the snom Vision:

Page 1

Image	Context/Type	Value	Name	Name	Value	Context/Type	Image
	Active Extension	141	Heidi	Michael	130	Active Extension	
	Active Extension	142	Lisa	Marie	131	Active Extension	
	Active Extension	143	Joao	Oliver		Active Extension	
	Active Extension	144	Martha	Tessa		Active Extension	
	Active Extension	145	Steve	Martin		Active Extension	
	Active Extension	146	Peter Miller	Birgit		Active Extension	
	Active Extension	147	Peter Smith	Marketing		Active Extension	
	Active Extension	148	Sales	Accounting		Active Extension	

Save current settings

Page 2

Image	Context/Type	Value	Name	Name	Value	Context/Type	Image
	Active Speed dial	0017815692044	Boston Office	Milan Office	00390200611212	Active Speed dial	
	Active Speed dial	0033180876487	Paris Office	UK Office	00441133503111	Active Speed dial	
	Active Speed dial	00886287511120	Taiwan Office	Smithers Inc		Active Speed dial	
	Active Speed dial	123456	Office Supplies	Travel Agency		Active Speed dial	
	Active Speed dial	234567	DHL	FedEx		Active Speed dial	
	Active Speed dial	345678	UPS	Taxi 1		Active Speed dial	
	Active Speed dial	456789	Taxi 2	Hotel Res. 1		Active Speed dial	
	Active Application	Info	Info	Hotel Res. 2		Active Speed dial	

Save current settings

	Boston Office	Milan Office	
	Paris Office	UK Office	
	Taiwan Office	Smithers Inc	
	Office Supplies	Travel Agency	
	DHL	FedEx	
	UPS	Taxi 1	
	Taxi 2	Hotel Res. 1	
	Info	Hotel Res. 2	

Button configuration

Page 3

Image	Context/Type	Value	Name	Name	Value	Context/Type	Image
	Active Forward to	148	Fwd. to Sales	Park Orbit 1	301	Active Park-Orbit	
	Active Forward to	136	Fwd. to Marketing	Park Orbit 2	302	Active Speed dial	
	Active Forward to	137	Fwd. to Accounting	Park Orbit 3		Active Speed dial	
	Active Intercom	101	Intercom Reception	Park Orbit 4		Active Speed dial	
	Active Multicast Page	201	Multicast Shop Floor 1	Multicast Shop Floor 2		Active Speed dial	
	Active Multicast Page	203	Multicast Shop Floor 3	Multicast Shop Floor 4		Active Speed dial	
	Active Multicast Page	200	Multicast all	Reboot		Active Event	
	Active Key Event	F_REDIRECT	Forward all calls	DND		Active Event	

Save current settings

	Fwd. to Sales	Park Orbit 1	
	Fwd. to Marketing	Park Orbit 2	
	Fwd. to Accounting	Park Orbit 3	
	Intercom Reception	Park Orbit 4	
	Multicast Shop Floor 1	Multicast Shop Floor 2	
	Multicast Shop Floor 3	Multicast Shop Floor 4	
	Multicast all	Reboot	
	Forward all calls	DND	

Using the snom Vision

The function keys on the snom Vision work like the function keys on the phone it is paired with. Please refer to the user manual of your phone for more information on the available functions.

The display screens

The snom Vision has 48 function keys on 3 display "pages". After the snom Vision has booted up, Page 1 is visible and Pages 2 and 3 can be put on-screen by pressing the left or right arrow keys below the display. Thereafter, whichever page is on-screen will remain there until you put another one on-screen (or until you reboot the snom Vision).

The arrow keys work in both directions like a revolving cylinder; pressing the left or right arrow key three times will bring you full circle to the screen you started out from.

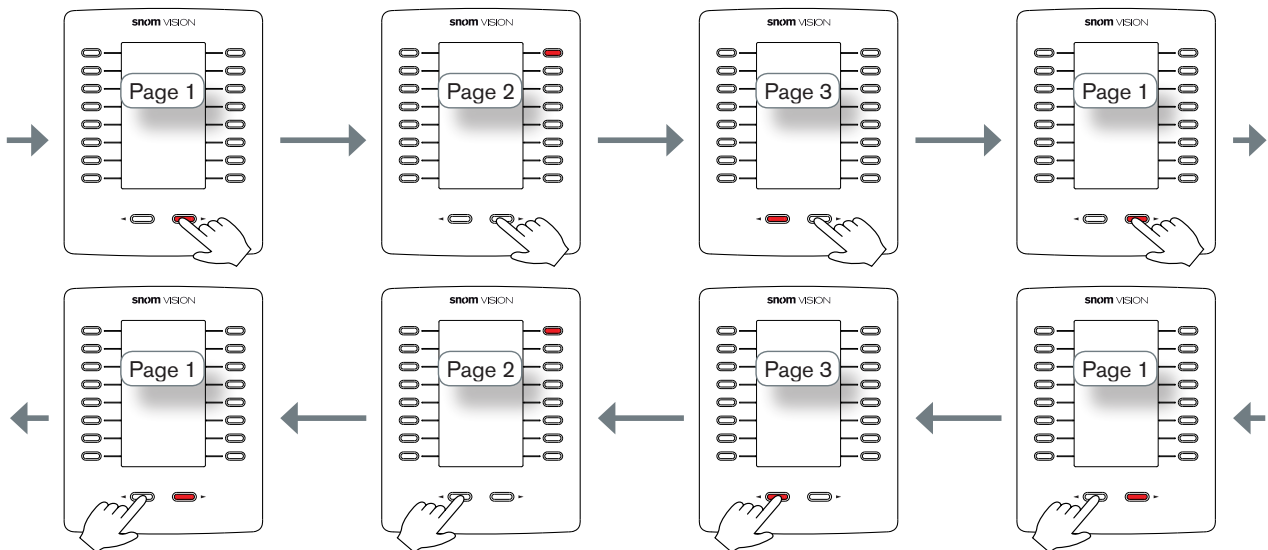

When a function key lights up on a page that is not visible at a given moment, the LED on one of the arrow keys lights up as well. In the following examples Page 2 is visible, and there are incoming calls on the two screens that are not visible. In Fig. 1, there is an incoming call on a monitored extension on Page 1; therefore, the LED on the left arrow key is blinking. In Fig. 2, there is an incoming call on a monitored extension on Page 3; therefore, the LED on the right arrow key is blinking. Pressing the blinking key will put the respective page on-screen, and you will see the blinking LED key of the monitored extension.

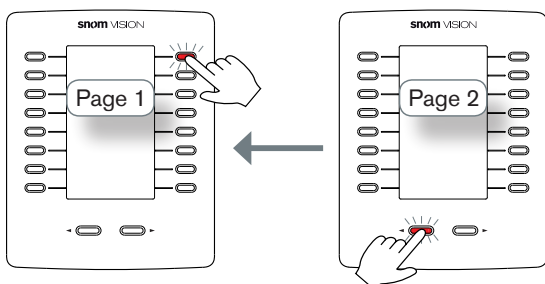

Fig. 1 / Abb. 1

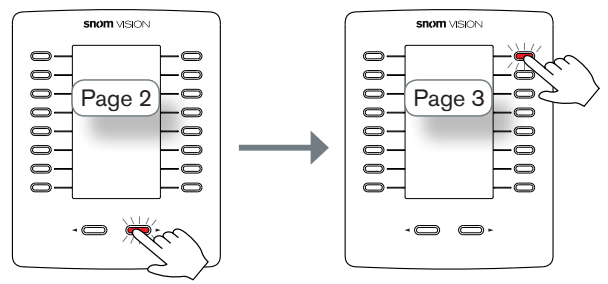
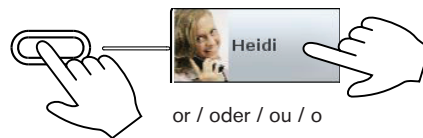

Fig. 2 / Abb. 2

Using the function keys

The function key you wish to use must be on-screen. To use it, you can either tap the key's touch screen area or press the associated hardkey.



Two of the most common uses of the functions keys are the functions **Extension** (or **BLF**, depending on your PBX) and **Speed dial**.

- Function key type Extension (or BLF, depending on your PBX). Examples:
 - If extension 157 is mapped onto an extension key, you can call that extension by touching the key's touch screen area or pressing the associated LED key.
 - If both your phone and extension 157 are allowing extension monitoring and are using the same group ID (and if this function is supported by your PBX):
 - Visible screen: The LED of the hardkey will blink red to indicate an incoming call ringing on extension 157; you can pick up unanswered calls on your phone by touching the key's touch screen area or pressing the associated LED key.
 - Invisible screens: If an incoming call is ringing on an extension mapped onto a function key on one of the two screens not visible at the time, the LED on one of the arrow key will blink red. Press the key with the blinking LED to make the screen visible. The LED of the hardkey will blink red to indicate an incoming call ringing on extension 157; you can pick up unanswered calls on your phone by touching the key's touch screen area or pressing the associated LED key

Function key type Speed dial:

- Call the speed dial number mapped onto the key by touching the key's touch screen area or pressing the associated LED key. You can also end the call by touching the touch screen button or pressing the hardkey.
- When a call comes in from a speed dial number, the LED either of the function key mapped with that speed dial number or of the corresponding arrow key will flash:
 - Visible screen: You can accept the call by touching the key's touch screen area or by pressing the flashing LED key. (This function must be supported by your PBX).
 - Invisible screens: If an incoming call from a speed dial number on one of the two screens not visible at the time is ringing, the LED on the corresponding arrow key will blink. Press the key with the blinking LED to make the screen visible. You can accept the call by touching the key's touch screen area or by pressing the flashing LED key. (This function must be supported by your PBX).

Appendix 1 - Key events

NAME	SYNTAX
ABS	F_ABS
Accepted Calls	F_ACCEPTED_LIST
Call Lists	F_CALL_LIST
Change active ID	F_REGS
Conference	F_CONFERENCE
Contacts	F_CONTACTS
Directory	F_ADR_BOOK
DND	F_DND
Favorites	F_FAVORITES
Forward all	F_REDIRECT
Help	F_HELP
Hold	F_HOLD
LDAP Directory	F_DIRECTORY_SEARCH
Logoff Identities	F_LOGOFF_ALL
Menu	F_SETTINGS
Missed Calls	F_MISSED_LIST
Monitor Calls (not available on snom 300)	F_DIALOG
Mute	F_MUTE
Next Outgoing ID	F_NEXT_ID
Presence State	F_PRESENCE
Prev. Outgoing ID	F_PREV_ID
Reboot	F_REBOOT
Record	F_RECORD
Redial	F_REDIAL
Retrieve	F_RETRIEVE
Status Messages	F_STATUS
Transfer	F_TRANSFER

Please refer to the phone's user manual and snom's Wiki for a description of these functions.

Appendix 2 - Initializing without DHCP

If your network does not support DHCP, you must obtain a static IP address, the netmask, and the IP gateway from your Internet service provider or your network administrator and enter them manually on the touchscreen.

- Delete character to the left of the cursor: 
- Delete all entries and start over: Press the right arrow key

Enter IP address, netmask, and IP gateway. Press the left arrow key when finished.

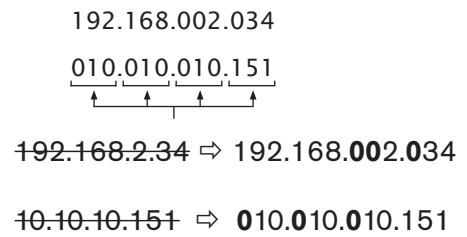
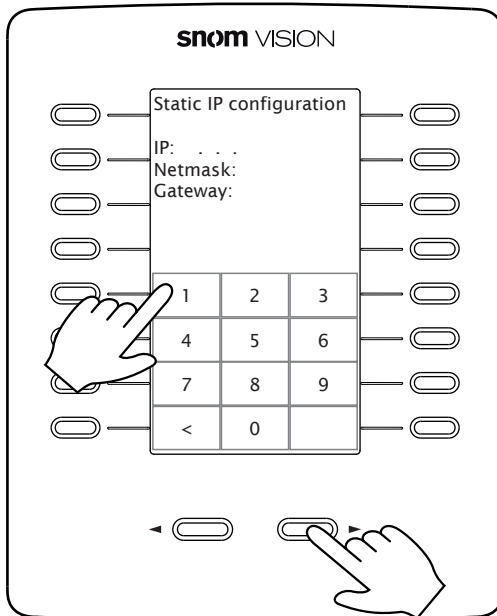

Appendix 3 - GNU General Public License

COPYRIGHT NOTICE AND WARRANTY DISCLAIMER

I.

Das Produkt enthält Software, die unter der GNU General Public License, Version 2, frei genutzt werden darf.

This Product contains Software applicable to GNU General Public License, Version 2 which can be used freely.

II.

Im Verhältnis zu den Lizenzgebern der Software gilt der folgende Haftungsausschluss:

Towards the licensor of this Software the following liability is disclaimed:

This program is distributed in the hope that it will be useful, but WITHOUT ANY WARRANTY; without even the implied warranty of MERCHANTABILITY or FITNESS FOR A PARTICULAR PURPOSE. See the GNU General Public License for more details.

III.

Der Lizenztext der GPL lautet wie folgt:
The GNU General Public License is as follows:

GNU GENERAL PUBLIC LICENSE Version 2, June 1991

Copyright (C) 1989, 1991
Free Software Foundation, Inc.
59 Temple Place, Suite 330
Boston, MA 02111-1307, USA

Everyone is permitted to copy and distribute verbatim copies of this license document, but changing it is not allowed.

Preamble

The licenses for most software are designed to take away your freedom to share and change it. By contrast, the GNU General Public License is intended to guarantee your freedom to share and change free software- to make sure the software is free for all its users. This General Public License applies to most of the Free Software Foundation's software and to any other program whose authors commit to using it. (Some other Free Software Foundation software is covered by the GNU Library General Public License instead.) You can apply it to your programs, too.

When we speak of free software, we are referring to freedom, not price. Our General Public Licenses are designed to make sure that you have the freedom to distribute copies of free software (and charge for this service if you wish), that you receive source code or can get it if you want it, that you can change the software or use pieces of it in new free programs; and that you know you can do these things.

To protect your rights, we need to make restrictions that forbid anyone to deny you these rights or to ask you to surrender the rights. These restrictions translate to certain responsibilities for you if you distribute copies of the software, or if you modify it. For example, if you distribute copies of such a program, whether gratis or for a fee, you must give the recipients all the rights that you have. You must make sure that they, too, receive or can get the source code. And you must show them these terms so they know their rights.

We protect your rights with two steps: (1) copyright the software, and (2) offer you this license which gives you legal permission to copy, distribute and/or modify the software.

Also, for each author's protection and ours, we want to make certain that everyone understands that there is no warranty for this free software. If the software is modified by someone else and passed on, we want its recipients to know that what they have is not the original, so that any problems introduced by others will not reflect on the original authors' reputations.

Finally, any free program is threatened constantly by software patents. We wish to avoid the danger that redistributors of a free program will individually obtain patent licenses, in effect making the program proprietary. To prevent this, we have made it clear that any patent must be licensed for everyone's free use or not licensed at all.

The precise terms and conditions for copying, distribution and modification follow.

GNU GENERAL PUBLIC LICENSE

TERMS AND CONDITIONS FOR COPYING, DISTRIBUTION AND MODIFICATION

0. This License applies to any program or other work which contains a notice placed by the copyright holder saying it may be distributed under the terms of this General Public License. The „Program“, below, refers to any such program or work, and a „work based on the Program“ means either the Program or any derivative work under copyright law: that is to say, a work containing the Program or a portion of it, either verbatim or with modifications and/or translated into another language. (Hereinafter, translation is included without limitation in the term „modification“.) Each licensee is addressed as „you“.

Activities other than copying, distribution and modification are not covered by this License; they are outside its scope. The act of running the Program is not restricted, and the output from the Program is covered only if its contents constitute a work based on the Program (independent of having been made by running the Program). Whether that is true depends on what the Program does.

1. You may copy and distribute verbatim copies of the Program's source code as you receive it, in any medium, provided that you conspicuously and appropriately publish on each copy an appropriate copyright notice and disclaimer of warranty; keep intact all the notices that refer to this License and to the absence of any warranty; and give any other recipients of the Program a copy of this License along with the Program.

You may charge a fee for the physical act of transferring a copy, and you may at your option offer warranty protection in exchange for a fee.

2. You may modify your copy or copies of the Program or any portion of it, thus forming a work based on the Program, and copy and distribute such modifications or work under the terms of Section 1 above, provided that you also meet all of these conditions:

- a) You must cause the modified files to carry prominent notices stating that you changed the files and the date of any change.
- b) You must cause any work that you distribute or publish, that in whole or in part contains or is derived from the Program or any part thereof, to be licensed as a whole at no charge to all third parties under the terms of this License.
- c) If the modified program normally reads commands interactively when run, you must cause it, when started running for such interactive use in the most ordinary way, to print or display an announcement including an appropriate copyright notice and a notice that there is no warranty (or else, saying that you provide a warranty) and that users may redistribute the program under these conditions, and telling the user how to view a copy of this License. (Exception: if the Program itself is interactive but does not normally print such an announcement, your work based on the Program is not required to print an announcement.)

These requirements apply to the modified work as a whole. If identifiable sections of that work are not derived from the Program, and can be reasonably considered independent and separate works in themselves, then this License, and its terms, do not apply to those sections when you distribute them as separate works. But when you distribute the same sections as part of a whole which is a work based on the Program, the distribution of the whole must be on the terms of this License, whose permissions for other licensees extend to the entire whole, and thus to each and every part regardless of who wrote it.

Thus, it is not the intent of this section to claim rights or contest your rights to work written entirely by you; rather, the intent is to exercise the right to control the distribution of derivative or collective works based on the Program. In addition, mere aggregation of another work not based on the Program with the Program (or with a work based on the Program) on a volume of a storage or distribution medium does not bring the other work under the scope of this License.

3. You may copy and distribute the Program (or a work based on it, under Section 2) in object code or executable form under the terms of Sections 1 and 2 above provided that you also do one of the following:

- a) Accompany it with the complete corresponding machine-readable source code, which must be distributed under the terms of Sections 1 and 2 above on a medium customarily used for software interchange; or,
- b) Accompany it with a written offer, valid for at least three years, to give any third party, for a charge no more than your cost of physically performing source distribution, a complete machine-readable copy of the corresponding source code, to be distributed under the terms of Sections 1 and 2 above on a medium customarily used for software interchange; or,
- c) Accompany it with the information you received as to the offer to distribute corresponding source code. (This alternative is allowed only for noncommercial distribution and only if you received the program in object code or executable form with such an offer, in accord with Subsection b above.)

The source code for a work means the preferred form of the work for making modifications to it. For an executable work, complete source code means all the source code for all modules it contains, plus any associated interface definition files, plus the scripts used to control compilation and installation of the executable. However, as a special

exception, the source code distributed need not include anything that is normally distributed (in either source or binary form) with the major components (compiler, kernel, and so on) of the operating system on which the executable runs, unless that component itself accompanies the executable.

If distribution of executable or object code is made by offering access to copy from a designated place, then offering equivalent access to copy the source code from the same place counts as distribution of the source code, even though third parties are not compelled to copy the source along with the object code.

4. You may not copy, modify, sublicense, or distribute the Program except as expressly provided under this License. Any attempt otherwise to copy, modify, sublicense or distribute the Program is void, and will automatically terminate your rights under this License. However, parties who have received copies, or rights, from you under this License will not have their licenses terminated so long as such parties remain in full compliance.

5. You are not required to accept this License, since you have not signed it. However, nothing else grants you permission to modify or distribute the Program or its derivative works. These actions are prohibited by law if you do not accept this License. Therefore, by modifying or distributing the Program (or any work based on the Program), you indicate your acceptance of this License to do so, and all its terms and conditions for copying, distributing or modifying the Program or works based on it.

6. Each time you redistribute the Program (or any work based on the Program), the recipient automatically receives a license from the original licensor to copy, distribute or modify the Program subject to these terms and conditions. You may not impose any further restrictions on the recipients' exercise of the rights granted herein. You are not responsible for enforcing compliance by third parties to this License.

7. If, as a consequence of a court judgment or allegation of patent infringement or for any other reason (not limited to patent issues), conditions are imposed on you (whether by court order, agreement or otherwise) that contradict the conditions of this License, they do not excuse you from the conditions of this License. If you cannot distribute so as to satisfy simultaneously your obligations under this License and any other pertinent obligations, then as a consequence you may not distribute the Program at all. For example, if a patent license would not permit royalty-free redistribution of the Program by all those who receive copies directly or indirectly through you, then the only way you could satisfy both it and this License would be to refrain entirely from distribution of the Program.

If any portion of this section is held invalid or unenforceable under any particular circumstance, the balance of the section is intended to apply and the section as a whole is intended to apply in other circumstances.

It is not the purpose of this section to induce you to infringe any patents or other property right claims or to contest validity of any such claims; this section has the sole purpose of protecting the integrity of the free software distribution system, which is implemented by public license practices. Many people have made generous contributions to the wide range of software distributed through that system in reliance on consistent application of that system; it is up to the author/donor to decide if he or she is willing to distribute software through any other system and a licensee cannot impose that choice. This section is intended to make thoroughly clear what is believed to be a consequence of the rest of this License.

8. If the distribution and/or use of the Program is restricted in certain countries either by patents or by copyrighted interfaces, the original copyright holder who places the Program under this License may add an explicit geographical distribution limitation excluding those countries, so that distribution is permitted only in or among countries not thus excluded. In such case, this License incorporates the limitation as if written in the body of this License.

9. The Free Software Foundation may publish revised and/or new versions of the General Public License from time to time. Such new versions will be similar in spirit to the present version, but may differ in detail to address new problems or concerns. Each version is given a distinguishing version number. If the Program specifies a version number of this License which applies to it and „any later version“, you have the option of following the terms and conditions either of that version or of any later version published by the Free Software Foundation. If the Program does not specify a version number of this License, you may choose any version ever published by the Free Software Foundation.

10. If you wish to incorporate parts of the Program into other free programs whose distribution conditions are different, write to the author to ask for permission. For software which is copyrighted by the Free Software Foundation, write to the Free Software Foundation; we sometimes make exceptions for this. Our decision will be guided by the two goals of preserving the free status of all derivatives of our free software and of promoting the sharing and reuse of software generally.

NO WARRANTY

11. BECAUSE THE PROGRAM IS LICENSED FREE OF CHARGE, THERE IS NO WARRANTY FOR THE PROGRAM, TO THE EXTENT PERMITTED BY APPLICABLE LAW. EXCEPT WHEN OTHERWISE STATED IN WRITING THE COPYRIGHT HOLDERS AND/OR OTHER PARTIES PROVIDE THE PROGRAM „AS IS“ WITHOUT WARRANTY OF ANY KIND, EITHER EXPRESSED OR IMPLIED, INCLUDING, BUT NOT LIMITED TO, THE IMPLIED WARRANTIES OF MERCHANTABILITY AND FITNESS FOR A PARTICULAR PURPOSE. THE ENTIRE RISK AS TO THE QUALITY AND PERFORMANCE OF THE PROGRAM IS WITH YOU. SHOULD THE PROGRAM PROVE DEFECTIVE, YOU ASSUME THE COST OF ALL NECESSARY SERVICING, REPAIR OR CORRECTION.

12. IN NO EVENT UNLESS REQUIRED BY APPLICABLE LAW OR AGREED TO IN WRITING WILL ANY COPYRIGHT HOLDER, OR ANY OTHER PARTY WHO MAY MODIFY AND/OR REDISTRIBUTE THE PROGRAM AS PERMITTED ABOVE, BE LIABLE TO YOU FOR DAMAGES, INCLUDING ANY GENERAL, SPECIAL, INCIDENTAL OR CONSEQUENTIAL DAMAGES ARISING OUT OF THE USE OR INABILITY TO USE THE PROGRAM (INCLUDING BUT NOT LIMITED TO LOSS OF DATA OR DATA BEING RENDERED INACCURATE OR LOSSES SUSTAINED BY YOU OR THIRD PARTIES OR A FAILURE OF THE PROGRAM TO OPERATE WITH ANY OTHER PROGRAMS), EVEN IF SUCH HOLDER OR OTHER PARTY HAS BEEN ADVISED OF THE POSSIBILITY OF SUCH DAMAGES.

END OF TERMS AND CONDITIONS

How to Apply These Terms to Your New Programs

If you develop a new program, and you want it to be of the greatest possible use to the public, the best way to achieve this is to make it free software which everyone can redistribute and change under these terms.

To do so, attach the following notices to the program. It is safest to attach them to the start of each source file to most effectively convey the exclusion of warranty; and each file should have at least the „copyright“ line and a pointer to where the full notice is found.

<one line to give the program's name and a brief idea of what it does>Copyright (C) <year> <name of author>

This program is free software; you can redistribute it and/or modify it under the terms of the GNU General Public License as published by the Free Software Foundation; either version 2 of the License, or (at your option) any later version.

This program is distributed in the hope that it will be useful, but WITHOUT ANY WARRANTY; without even the implied warranty of MERCHANTABILITY or FITNESS FOR A PARTICULAR PURPOSE. See the GNU General Public License for more details.

You should have received a copy of the GNU General Public License along with this program; if not, write to the Free Software Foundation, Inc., 59 Temple Place, Suite 330, Boston, MA 02111-1307 USA

IV.

Den vollständigen korrespondierenden Sourcecode der Software schickt Ihnen die snom technology AG auf Nachfrage gerne auf einem üblichen Datenträger gegen Erstattung der Herstellungskosten in Höhe von EUR 5,- zu.

Der vollständige korrespondierende Sourcecode kann auch über unsere Website unter http://www.snom.com/gpl_.html?&L=0 herunter geladen werden.

If requested by you, the complete corresponding source code of the Software can be sent by snom technology AG on a standard data storage medium against the reimbursement of the manufacturing costs of EUR 5.- per unit.

The complete corresponding source code of the Software can also be downloaded from our web site http://www.snom.com/gpl_.html?&L=0.

V..

Weitere Informationen finden Sie auch unter <http://www.snom.com>.

For further information see <http://www.snom.com>.

snom technology AG
Charlottenstr. 68-71
10117 Berlin, Deutschland
Tel. +49 30 39 83 3-0
Fax +49 30 39 83 31 11
info@snom.com, sales@snom.com

snom France SARL
6 Parc des fontenelles
78870 Bailly, France
Tel. +33 1 80 87 62 87
Fax +33 1 80 87 62 88
info@snom.com, sales@snom.com

snom technology, Inc.
18 Commerce Way, Suite 6000
Woburn, MA 01801, USA
Tel. 781-569-2044
Fax 978-998-7883
infoUSA@snom.com

snom technology SRL
Via A. Lusardi 10
20122 Milano, Italia
Tel +39 02 00611212
Fax +39 02 93661864
info@snom.com, sales@snom.com

snom UK Ltd
Aspect Court
47 Park Square East
Leeds, LS12NL, UK
Tel. +44 1133 503 111
Fax +44 1133 503 110
uksales@snom.com, info@snom.com

snom technology Ltd.
Rm. A2, 3F, No. 37, Ln. 258
Ruiguang Rd., Neihu Dist.
Taipei City 114, Taiwan
Tel +886-2-8751-1120
Fax +886-2-8751-1130
infoASIA@snom.com

**Your specialist retailer - Ihr Fachhändler -
Votre distributeur - Su distribuidor - Il tuo rivenditore:**

