



Quick Start Guide

snom[®] VISION

ENGLISH
DEUTSCH
FRANÇAIS
ITALIANO
ESPAÑOL

A

**Delivery content - Lieferumfang - Contenu de l'emballage -
En la caja - Contenuto della confezione - Incluídos no pacote**

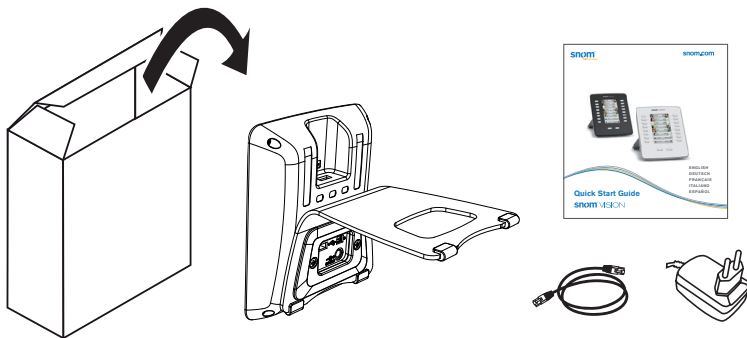
**B**

- Detaching/attaching
- Abmontieren/montieren
- Démontar/attacher
- Desmontar/montaje
- Smantellare/fissare

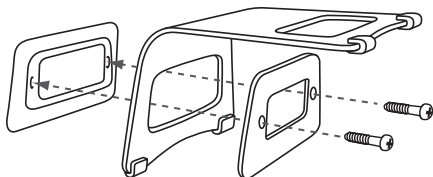
**C**

**Connecting - Anschließen -
Connector - Connector - Collegare**

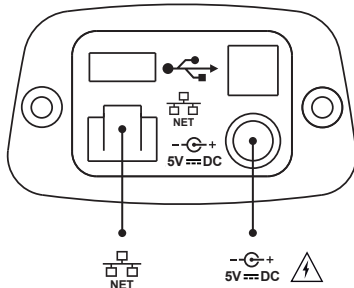

PoE

*If PoE not available
Wenn PoE nicht verfügbar
S'il n'y a pas de PoE
Si no se dispone de PoE
Se non disponibile PoE*

D

**At a glance - Auf einen Blick - D'un seul coup d'oeil -
In sintesi - De un vistazo**

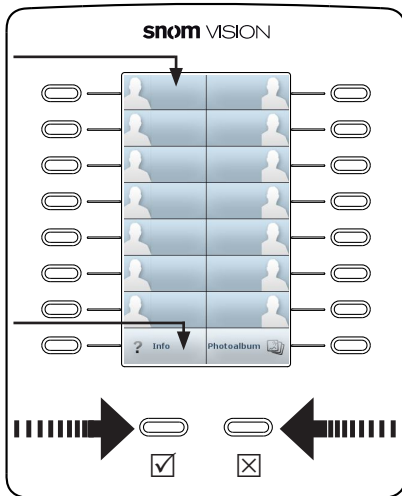
1**2****3****4**

- 1**
- Extension or line
 - Nebenstelle oder Leitung
 - Poste supplémentaire ou ligne extérieure
 - Interno o linea
 - Extensión o línea

2

If available - falls verfügbar - si disponible - si disponibile - si está disponible:

3

- Additional extensions + lines
- Weitere Nebenstellen + Leitungen
- Autres postes supplémentaires + lignes extérieures

4

- Interni y linee aggiuntive
- Extensiones y líneas adicionales

ENGLISH	5
Initializing and registering via DHCP ▪ Configuring	
DEUTSCH	9
Initialisierung und Registrierung über DHCP ▪ Einstellungen	
FRANÇAIS	13
Initialisation et enrégistrement avec DHCP ▪ Configurer les paramètres	
ITALIANO	17
Inizializzazione e registrazione tramite DHCP ▪ Impostazioni	
ESPAÑOL	21
Inicialización e registraci3n sin DHCP ▪ Configuraci3n	
 APPENDICES ▪ ANLAGEN ▪ ANNEXES ▪ APENDICI ▪ ANEXOS	
1. Initializing and registering without DHCP ▪ Initialisierung und Registrierung ohne DHCP ▪ Initialisation et enrégistrement sans DHCP ▪ Inizializzazione e registrazione senza DHCP ▪ Inicializaci3n e registraci3n sin DHCP	25
2. GNU General Public License	27

This quick start guide describes the installation and setup of the snom Vision. For further information please refer to the manual on our web page,

http://wiki.snom.com/Accessories/snom_Vision

Copyright, Trademarks, GPL, Legal Disclaimers

© 2012 snom technology Aktiengesellschaft
All Rights Reserved.

snom, the names of snom products, and snom logos are trademarks owned by snom technology AG. All other product names and names of enterprises are the property of their respective owners.

Product specifications are subject to change without notice.

snom technology AG reserves the right to revise and change this document at any time, without being obliged to announce such revisions or changes beforehand or after the fact. Texts, images, and illustrations and their arrangement in this document are subject to the protection of copyrights and other legal rights worldwide. Their use, reproduction, and transmittal to third parties without express written permission may result in legal proceedings in the criminal courts as well as civil courts.

Although due care has been taken in the compilation and presentation of the information in this document, the data upon which it is based may have changed in the meantime. snom therefore disclaims all warranties and liability for the accurateness, completeness, and currentness of the information published, except in the case of intention or gross negligence on the part of snom or where liability arises due to binding legal provisions.

Our firmware includes some source code that may be used and modified by anyone and everyone under the GNU Public License (GPL) (see Appendix on page), provided they, in turn, make it available to everyone else with the same licensing agreement. Please go to <http://www.snom.com/en/support/download/gpl-quellcode/> for the original GPL license and the source code of components licensed under GPL and used in snom products.

Important Information

Please read the instructions on safety and disposal and on how to set up and use the device before using it and also give them to other users to read or inform those users of their contents. Save this manual and do not give the device to third parties without it.

Safety Instructions

Follow the instructions in this manual and other applicable documentation of the device.

- If the phone is not supplied with power via an Ethernet cable, use only the power adapter included in the package or one expressly recommended by snom technology. Other power supplies may damage or destroy the phone, affect its behavior, or induce noise.
- Avoid placing the cables where people may trip over them or where they may be exposed to mechanical pressure as this may damage them.
- This device is for indoor use only! Do not install outdoors - NOT FOR OUTDOOR USE!
- Do not install the device in rooms with high humidity (for example, in bathrooms, laundry rooms, damp basements). Do not immerse the device in water and do not spill or pour liquids of any kind onto or into the device.
- Do not install the device in surroundings at risk for explosions (paint shops, for example). Do not use the device if you smell gas or other potentially explosive fumes.
- Do not use the device during thunderstorms. Lightning striking the power grid may cause electric shocks.

SELV (Safety Extra Low Voltage) Compliance

Safety status of Input/Output connections comply with SELV requirements.

Warning: To avoid electric shock, do not connect safety extra-low voltage (SELV) circuits to telephone-network voltage (TNV) circuits. LAN ports contain SELV circuits, and PSTN ports contain TNV circuits. Some LAN and PSTN ports both use RJ-45 (8P8C) connectors. Use caution when connecting cables.

Standards conformance



This device is CE and FCC-certified and meets European and US health, safety, and environmental standards.



Unauthorized opening, changing, or modifying the device will cause the warranty to lapse and may also result in the lapse of the CE and FCC certifications. In case of malfunction contact authorized service personnel, your seller, or snom.

- Safety: IEC 60950-1:2005
- Certifications: FCC Class B, CE Mark
- Power consumption: 2.5 - 7 watts (without USB peripherals)
- Power: 5 V DC
- 1 x LAN: RJ45 (Ethernet) 1 x 10/100 Mbps
- Power over Ethernet: IEEE 802.3af, Class 2
- USB connector slots: 2 x type A, 1 x type B

Disposal of the device



This device is subject to European Directive 2002/96/EC and may not be disposed of with general household garbage.

If you do not know where you may dispose of the device at the end of its lifespan, contact your municipality, your local waste management provider, or your seller.

Cleaning

To clean the device, use an anti-static cloth. Please avoid cleaning liquids as they might damage the surface or internal electronics of the device.

Initializing and registering

Normally the initialization and registration is completely automatic, using DHCP.

If your network does not support DHCP, see page 25.

Configuring the settings

Open a web browser on your PC. Enter the snom Vision's IP address (for example, http://10.10.10.115) in the address bar and press ENTER to open its web interface. Click on "Extension Module" in the menu on the left side. Make entries as necessary. Press  to save and move the cursor to the next field.

Phone IP: IP address of the phone you are connecting to the expansion module

User & Password: The user name and password for the web interface of the phone. Leave blank if none have been set.

Identity for outgoing calls: Optional. If none is set the current outgoing identity of the phone will be used.

Image: Click on the image to open the window for uploading an image file or deleting the current image

Value: Enter extension number or outside phone number

Name: Enter the name or number to be shown on the display

Select image to upload: Enter the URL of the image file and click on "Upload"

Phone configuration

Phone IP: http https

User:

Password:

Button configuration

Page 1 ▾

Image	Context/Type	Value	Name
	Identity 2 ▾	158	Michelle Martin
	Speed dial ▾		

Select image to upload

Delete image

Diese Kurzanleitung beschreibt die Installation, Einrichtung und den Betrieb des snom Vision. Weitere Informationen finden Sie auf unserer Webseite,

http://wiki.snom.com/Accessories/snom_Vision

Copyright, Markenrechte, GNU Lizenz, Haftung

© 2012 snom technology Aktiengesellschaft
Alle Rechte reserviert.

snom sowie die Namen der snom-Produkte und die snom logos sind gesetzlich geschützte Marken der snom technology AG. Alle anderen Produkt- und Firmennamen sind Marken der jeweiligen Inhaber.

Produktspezifikationen können ohne Vorankündigung verändert werden.

snom technology AG behält sich jederzeit das Recht auf Überarbeitung und Änderung dieses Dokumentes vor, ohne verpflichtet zu sein, die vorgenommenen Änderungen anzukündigen oder mitzuteilen.

Texte, Bilder, Grafiken und deren Anordnung in diesem Dokument unterliegen weltweit dem Schutz des Urheberrechts und anderen Schutzgesetzen. Ihre Verwendung, Reproduktion oder Weitergabe ohne ausdrückliche schriftliche Zustimmung der snom technology AG können sowohl straf- als auch zivilrechtlich verfolgt werden.

Trotz der angewandten Sorgfalt bei der Zusammenstellung und Präsentation der Informationen in diesem Dokument können sich Daten zwischenzeitlich geändert haben. Daher übernimmt snom keine Gewähr für die Richtigkeit, Vollständigkeit oder Aktualität der zur Verfügung gestellten Informationen. Jegliche Haftung für Schäden ist ausgeschlossen, sofern diese nicht auf Vorsatz oder grober Fahrlässigkeit auf seiten von snom beruhen oder sofern keine Haftung aufgrund zwingender gesetzlicher Bestimmungen eintritt.

Unsere Firmware enthält teilweise Quellcodes, die unter der GNU Public License (GPL) von jedermann genutzt und modifiziert werden dürfen, solange sie wiederum mit denselben Lizenzbedingungen zur allgemeinen Nutzung veröffentlicht werden. Die Quellcodes der von snom genutzten und der GPL unterliegenden Komponenten können Sie auf der Supportseite unserer Webseite auf www.snom.com, den Wortlaut der GPL auf <http://www.snom.com/de/support/download/gpl-quellcode/> herunterladen.

Wichtige Hinweise

Lesen Sie bitte vor Inbetriebnahme die Sicherheitshinweise und die Bedienungsanleitung. Lassen Sie sie auch von den Mitbenutzern des Gerätes lesen oder informieren Sie sie über deren Inhalt. Bewahren Sie diese Bedienungsanleitung auf und geben Sie das Telefon nur mit der Bedienungsanleitung an Dritte weiter..

Sicherheit

Befolgen Sie die Anweisungen in dieser Bedienungsanleitung und in der sonstigen Dokumentation des Geräts.

- Falls die Stromversorgung nicht über das Ethernetkabel erfolgt, verwenden Sie nur das mitgelieferte Netzteil. Die Verwendung anderer Netzteile könnte das Telefon beschädigen oder gar zerstören.
- Vermeiden Sie es, die Netz- und Stromkabel so zu verlegen, dass sie durch mechanischen Druck beschädigt werden oder dass Personen darüber stolpern könnten.
- Dieses Gerät ist nur für den Gebrauch in Innenräumen bestimmt - NICHT FÜR DEN AUSSENBEREICH!
- Stellen Sie das Telefon nicht in Räumen mit hoher Luftfeuchtigkeit wie z.B. Badezimmern, Waschküchen, feuchten Kellerräumen auf. Tauchen Sie das Telefon nicht in Wasser und gießen Sie keine Flüssigkeiten auf oder in das Gerät.
- Stellen Sie das Telefon nicht in explosionsgefährdeten Umgebungen (z.B. Lackierereien) auf. Benutzen Sie das Telefon nicht, wenn Sie Gas oder andere möglicherweise explosionsgefährliche Dämpfe riechen.
- Telefonieren Sie nicht während eines Gewitters (Stromschlaggefahr bei Blitzeinschlag ins Netz).

SELV (Safety Extra Low Voltage) Einhaltung

Die Eingangs-/Ausgangsverbindungen halten die SELV-Richtlinien für Kleinspannungsgeräte ein.

Warnung: Um elektrische Schläge zu vermeiden, verbinden Sie keine SELV-Geräte mit Geräten, die Telefon-/Netzwerk-Spannung (TNV) führen. Nur an LAN-Ports anschließen!

Normkonformität



Dieses Gerät ist CE- und FCC-geprüft und entspricht den geltenden europäischen und US-amerikanischen Richtlinien.



Die eigenmächtige Öffnung des Geräts sowie Änderungen und Modifizierungen am Gerät führen zum Erlöschen der Gewährleistungspflicht und können darüberhinaus zum Erlöschen der Zulassungen führen. Wenden Sie sich bei Betriebsstörungen oder Defekten an autorisiertes Servicepersonal, an Ihren Verkäufer oder an snom.

- Sicherheit: IEC 60950-1:2005
- Zertifikate: FCC Class B, CE Mark
- Stromspeisung: Über Netzwerk (PoE, IEEE 802.3af, Klasse 2) oder Netzteil 5 V DC
- Leistungsaufnahme: 2,5 - 7 Watt (ohne USB-Peripheriegeräte)
- 1 x LAN: RJ45 (Ethernet) 1 x 10/100 Mbps
- USB-Anschlüsse: 2 x Typ A, 1 x Typ B

Entsorgung des Produkts



Dieses Gerät unterliegt der europäischen Richtlinie 2002/96/EG und darf nicht im Hausmüll entsorgt werden.

Wenn Sie nicht wissen, wo Sie Ihr Altgerät entsorgen können, wenden Sie sich bitte an Ihre Kommune, Ihren örtlichen Müllentsorger oder Ihren Fachhändler.

Reinigung

Benutzen Sie ein antistatisches Tuch. Benutzen Sie kein Wasser und keine Reinigungsflüssigkeiten, da sie die Oberfläche und die Elektronik des Gerätes beschädigen könnten.

Initialisierung und Registrierung

Die Initialisierung und Registrierung erfolgt normalerweise automatisch über DHCP.

Falls DHCP in Ihrem Netzwerk nicht zur Verfügung steht, siehe Seite 25.

Einstellungen

Öffnen Sie den Webbrowser Ihres PCs, tippen Sie `http://` und die IP-Adresse in die Adresszeile (z. B. `http://10.10.10.115`) und drücken Sie auf die Eingabe-Taste, um die Webseite des snom Vision zu öffnen. Klicken Sie im linken Menü auf **Click on "Extension Module"**. Nehmen Sie die erforderlichen Eingaben vor. Drücken Sie auf , um zu speichern und in das nächste Eingabefeld zu gelangen.

Phone IP: IP-Adresse des Telefons, an das Sie das Erweiterungsmodul anschließen

User & Password: Benutzername und Kennwort zum Öffnen des Webbrowsers des Telefons, falls erforderlich

Identity for outgoing calls: Identität für ausgehende Anrufe. Wenn Sie keine Identität eingeben, wird die jeweilige ausgehende Identität des Telefons genommen.

Image: Klicken Sie auf die Bildfläche, um das Fenster zum Herunterladen oder Löschen einer Bilddatei zu öffnen

Value: Geben Sie die Nummer einer Nebenstelle oder eines externen Anschlusses ein

Name: Geben Sie den Namen oder die Nummer ein, die auf dem Bildschirm angezeigt werden sollen

Select image to upload: Geben Sie die URL der Bilddatei ein und klicken Sie auf "Upload"

Delete Image: Klicken Sie auf "Delete", um das derzeitige Bild zu löschen

Phone configuration

Phone IP: http https

User:

Password:

Button configuration

Page 1 ▾

Image	Context/Type	Value	Name
	Identity 2 ▾ Speed dial	158	Michelle Martin

Select image to upload

Delete image

Ce manuel abrégé décrit l'installation, l'initialisation et la mise en service du snom Vision. Consultez notre site web pour des informations complémentaires:

http://wiki.snom.com/Accessories/snom_Vision

Copyright, Marques Déposées, GPL, Non Responsabilité

© 2012 snom technology Aktiengesellschaft

Tous droits réservés.

snom, les noms des produits snom et les logos snom sont des marques déposées par snom technology AG. Tous les autres noms de produits et noms d'entreprises sont les propriétés de leurs détenteurs respectifs.

Toutes les spécifications du produit peuvent être modifiées sans préavis.

snom technology AG se réserve le droit de modifier et de changer ce document à n'importe quel moment, sans devoir annoncer de telles modifications ou changements avant ou après leur mise en place.

Les textes, images et illustrations ainsi que leur mise en page dans ce document sont protégés par les copyrights et autres dispositions légales internationales. Leur utilisation, leur reproduction et leur transmission à des parties tierces sans accord express écrit peut induire des poursuites devant les cours criminelles et civiles.

Bien que le plus grand soin ait été apporté à la compilation et à la présentation des informations contenues dans ce document, les données sur lesquelles elles sont basées peuvent entre-temps avoir été modifiées. snom doit donc décliner toute garantie et toute responsabilité quand à l'exactitude et à l'exhaustivité des informations publiées excepté en cas de négligence flagrante de la part de snom ainsi que des les cas ou la responsabilité de snom est engagée de par la loi.

Notre firmware inclus des éléments de code source qui peuvent être utilisés et modifié par quiconque selon les termes des licences GPL (cf. page 110), à condition qu'à leurs tours ils les rendent disponibles selon les mêmes termes. Veuillez vous rendre sur <http://www.snom.com/de/support/download/gpl-quellcode/> pour consulter la licence GPL originelle et le code source des composants couverts par la licence GPL qui sont utilisé dans les produits snom.

Informations importantes

Veillez lire les informations concernant la sécurité et la mise au rebut de l'appareil ainsi que celles concernant son installation et son utilisation avant d'utiliser l'appareil. Communiquez également ces informations aux autres utilisateurs ou faites-les leur lire. Conservez ce manuel et ne cédez pas l'appareil à une tierce partie sans y joindre le manuel.

Sécurité

Suivez les instructions présentes dans ce manuel et dans les autres documents concernant l'appareil.

- Evitez de placer le câble d'alimentation de l'appareil dans un endroit où il est possible de trébucher dessus. Evitez également de le placer là où il pourrait être exposé à un écrasement car il pourrait en être endommagé. Si le cordon d'alimentation ou la fiche sont endommagés, débranchez l'appareil et contactez du personnel d'entretien qualifié.
- Cet appareil est destiné à une utilisation en intérieur uniquement! Ne l'installez pas au dehors!
- N'installez pas l'appareil dans des pièces très humides (par exemple, dans une salle de bain, une buanderie ou un sous-sol humide). N'immergez pas l'appareil dans l'eau et ne versez pas de liquides d'aucune sorte sur ou dans l'appareil.
- N'installez pas l'appareil dans un lieu présentant un risque d'explosion (un magasin de peinture par exemple). N'utilisez pas l'appareil si vous sentez une odeur de gaz ou d'autres émanations potentiellement explosives.
- N'utilisez pas l'appareil durant les orages, le choc d'un éclair sur les circuits électriques peut provoquer une électrocution.

Conforme à T.B.T.S (Très Basse Tension de Sécurité)

Le niveau de sécurité des connexions d'entré/sortie est conforme aux recommandations T.B.T.S (SELV).

Avertissement : Pour éviter les électrocutions, ne connectez pas les circuits de SELV / TBTS aux circuits sous tension du réseau téléphonique (TNV). Ne connectez le câble NET/Ethernet qu'à un port LAN!

Conformité au standards



Cet appareil est certifié CE et FCC et répond aux standards environnementaux, de sécurité et de santé européens et américains.



L'ouverture, la modification ou le remplacement sans autorisation de l'appareil annule la garantie et peut également annuler les certifications CE et FCC. En cas de mauvais fonctionnement, veuillez contacter le personnel d'entretien agréé, votre revendeur ou bien snom.

- Sécurité: IEC 60950-1:2005
- Certificat: FCC Class B, CE Mark
- Consommation d'énergie: 2,5 - 7 Watts (sans périphériques informatiques US)
- Alimentation: Par transformation 5 V DC ou PoE (Power over Ethernet) IEEE 802.3af, Classe 2
- 1 x LAN: RJ45 (Ethernet) 1 x 10/100 Mbps
- Connecteurs USB: 2 x type A, 1 x type B

Mise au Rébut du Produit



Cet appareil est soumis à la Directive 2002/96/CE et ne peut être mis au rebut avec les déchets ménagers normaux.

Si vous ne savez pas où mettre au rebut ou faire recycler l'appareil lorsqu'il arrive au terme de son existence, contactez votre municipalité, la société locale en charge de la gestion des déchets ou votre vendeur.

Nettoyage

Utilisez un tissu antistatique. N'utilisez pas de l'eau ou un produit de nettoyage liquide ou solide. Ils peuvent endommager l'électronique ou les surfaces de l'appareil.

Initialisation et enrégistration

L'initialisation et l'enrégistration est normalement fait automatiquement via DHCP.

Si votre réseau ne supporte pas le protocole DHCP, voir la page 25.

Configurer les paramètres

Ouvrez le navigateur web de votre PC et saisissez l'adresse IP de l'appareil dans la barre d'adresse. Exemple: `http://10.10.10.115`. Cliquez sur Click on "Extension Module" au menu à gauche. Appuyez sur la touche d'entrée pour ouvrir la page d'accueil de l'interface Web de l'appareil. Appuyez sur  pour sauvegarder votre modifications et déplacer le curseur dans le champ suivant.

Phone IP: Adresse IP du téléphone à laquelle vous voulez enregistrer le module snom Vision

User & Password: Le nom d'utilisateur et mot de passe pour l'interface web du téléphone. Laissez vide si aucun n'a été fixé.

Identity for outgoing calls: L'identité pour les appels sortants. Si aucun n'est défini, l'identité sortant du téléphone sera utilisé.

Image: Cliquez sur l'image pour ouvrir la fenêtre pour le téléchargement d'un fichier image ou la suppression de l'image courante

Value: Entrez le numéro de poste ou le numéro de téléphone à l'extérieur

Name: Entrez le nom ou le numéro doit être indiqué sur l'écran

Select image to upload: Entrez l'URL de l'image fichier à télécharger et cliquez sur "Upload"

Delete Image: Cliquez sur "Delete" pour supprimer l'image actuelle

Phone configuration

Phone IP: http https

User:

Password:

Button configuration

Page 1

Image	Context/Type	Value	Name
	Identity 2 <input type="button" value="v"/>	158 <input type="text"/>	Michelle Martin
	Speed dial <input type="button" value="v"/>		

Select image to upload

Delete image

Questa è la guida rapida per l'installazione, l'impostazione e il funzionamento dello snom Vision. Per ulteriori informazioni consultare la nostra pagina web:

http://wiki.snom.com/Accessories/snom_Vision

Copyright, Marchi registrati, GPL, Declinazione di responsabilità

© 2012 snom technology Aktiengesellschaft

Tutti i diritti riservati.

snom, i nomi dei prodotti snom, ed i loghi snom sono marchi registrati di proprietà di snom technology AG. Tutti gli altri nomi di prodotti e di imprese sono proprietà dei rispettivi proprietari.

Le specifiche dei prodotti contenute in questo documento possono variare senza previa notifica.

snom technology AG si riserva il diritto di rivedere e modificare il presente documento in qualsiasi momento senza alcun obbligo di notifica precedente o posteriore a tali cambiamenti.

Testi, immagini ed illustrazioni ed il loro ordine in questo documento sono soggetti a protezione del diritto d'autore ed altri diritti legali a livello mondiale. Il loro utilizzo, riproduzione e trasmissione a terzi senza il permesso scritto potrebbe dar luogo ad azioni legali, in sede penale e civile.

Sebbene sia stata prestata la massima attenzione nella stesura e presentazione delle informazioni in questo documento, i dati su cui si basa potrebbero già aver subito variazioni. snom pertanto declina ogni responsabilità riguardo a tutte le garanzie di affidabilità, accuratezza, completezza ed attualità delle informazioni pubblicate, tranne nel caso di grossolana negligenza da parte di snom o laddove per legge è ritenuta responsabile.

Il nostro firmware include codice sorgente utilizzabile e modificabile da chiunque. La licenza pubblica GNU (GPL) (cfr. pag. 92), consente di rendere disponibile il software con lo stesso accordo di licenza. Visitate <http://www.snom.com/de/support/download/gpl-quellcode/> per la licenza GPL originale e per i codici di sorgente di componenti sotto licenza GPL ed utilizzati in prodotti snom.

Informazioni importanti

Pregasi leggere con attenzione le istruzioni inerenti la sicurezza, lo smaltimento e l'installazione del dispositivo prima del suo impiego. Tali informazioni vanno condivise con gli altri utenti. È altresì necessario conservare questo manuale, consegnandolo insieme al dispositivo qualora esso venga dato a terzi.

Sicurezza

Seguite le istruzioni in questo manuale e tutta la documentazione relativa al dispositivo.

- Utilizzate solo l'adattatore del dispositivo. Altri adattatori di corrente potrebbero danneggiare, anche irreversibilmente, il dispositivo soggetto a pressione meccanica ed il cavo. Se il cavo o la spina si danneggiano, scollegare il dispositivo e contattare il personale di assistenza qualificato.
- Non posizionare il cavo di corrente del telefono dove può essere calpestato. Non posizionare il cavo di corrente del telefono dove può essere soggetto a pressione meccanica perchè potrebbe danneggiare il cavo. Se il cavo o la spina si danneggiano, scollegare il telefono e contattare il personale di assistenza qualificato.
- Questo apparecchio si può impiegare solo al chiuso! Non installare all'aperto!
- Non installare il dispositivo in ambienti con alta umidità (ad es., in bagno, lavanderia, seminterrati umidi). Non immergere il dispositivo in acqua e non versarvi liquidi sopra
- Non installare il dispositivo nei pressi di locali a rischio esplosione (colorifici, ad es.). Non utilizzare il dispositivo se sentite odore di gas o di altra esalazione potenzialmente esplosiva.
- Non utilizzare il dispositivo durante i temporali. Qualora un fulmine colpisca la rete elettrica, è passibile di scossa.

Conforme al circuito SELV (bassissima tensione di sicurezza)

Il livello di sicurezza dei circuiti in ingresso / uscita è conforme alle raccomandazioni SELV.

Attenzione: Per evitare scosse elettriche non collegare i circuiti SELV a quelli della rete telefonica (TNV). Le porte LAN hanno circuiti SELV, le porte PSTN hanno circuiti TNV. Alcune porte LAN e PSTN fanno uso di connettori RJ-45. Fare attenzione quando si collegano cavi.

Conformità



Il dispositivo è certificato CE e FCC e risponde agli standard europei e statunitensi di salute, sicurezza ed ambientali.



Eventuali modifiche, cambiamenti e l'apertura non autorizzata del dispositivo invalidano la garanzia e potrebbero eventualmente annullare le certificazioni CE e FC. In caso di malfunzionamento contattare il personale di assistenza autorizzato, il rivenditore, o snom.

- Sicurezza: IEC 60950-1:2005
- Certificazioni: FCC Class B, Marchio CE
- Consumo di potenza: 2,5 - 7 Watt (senza unità perifericas)
- Potenza: 5 V DC o PoE (Power over Ethernet) IEEE 802.3af, Class 2
- 1 x LAN: RJ45 (Ethernet) 1 x 10/100 Mbps
- Connettori USB: 2 x tipo A, 1 x tipo B

Smaltimento del dispositivo



Questo dispositivo è soggetto alla Direttiva Europea 2002/96/EC e non può essere smaltito con i rifiuti domestici.

Se non sapete come smaltire l'apparecchio una volta inutilizzabile, contattate il comune, la nettezza urbana locale, o il vostro rivenditore.

Pulizia

Utilizzare un panno antistatico. Evitare acqua e altri liquidi o detersivi solidi che potrebbero danneggiare la superficie o l'elettronica interna.

Inizializzazione e registrazione

L'inizializzazione e la registrazione avviene normalmente tramite DHCP.

Se la tua rete non supporta il DHCP, vedi pagina 25.

Impostazioni

Aprire il browser web del vostro PC e digitare l'indirizzo IP di snom Vision nella barra degli indirizzi (p.es. http://10.10.10.115.). Premere Invio per aprire l'interfaccia Web di snom Vision e cliccare su "Extension Module" nel menu a sinistra. Effettuare le impostazioni necessarie. Premere su  per salvare e spostare il cursore al campo successivo.

Phone IP: L'indirizzo IP del telefono a cui si vuole collegare il modulo di espansione

User & Password: Nome utente e password per l'interfaccia web del telefono. Lasciare vuoto se non sono state impostate

Identity for outgoing calls: Identità per la chiamata in uscita. Se non si immette un'identità, l'apparecchio impiega l'identità corrente del telefono.

Image: Clicca sull'immagine per aprire la finestra per caricare o eliminare un'immagine

Value: Inserisci qui il numero di interno desiderato o un recapito telefonico esterno

Name: Immettere il nome o il numero da visualizzare sul display

Select image to upload: Inserisci l'URL dell'immagine da caricare e cliccare su "Upload"

Delete Image: Clicca su "Delete" per eliminare l'immagine corrente



Phone configuration

Phone IP: http https

User:

Password:

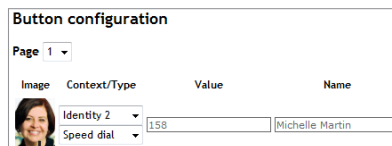

Button configuration

Page 1

Image	Context/Type	Value	Name
	Identity 2	158	Michelle Martin
	Speed dial		

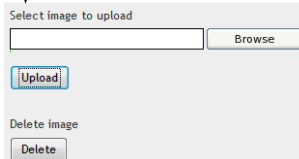

Select image to upload

Delete image

Esta es la Guía de Inicio Rápido para la instalación, configuración y uso del snom Vision. Para más información, consulte el manual en nuestra página web

http://wiki.snom.com/Accessories/snom_Vision

Propiedad intelectual, Marcas registradas, GPL, Exención de responsabilidad

© 2012 snom technology Aktiengesellschaft

Todos los derechos reservados.

snom, los nombres de los productos snom, y los logos de snom son marcas comerciales propiedad de snom technology AG. Los demás nombres de producto y empresas son propiedad de sus respectivos propietarios.

Las especificaciones de los productos contenidas en este documento pueden modificarse sin previo aviso.

snom technology AG se reserva el derecho de revisar y modificar este documento en cualquier momento, sin obligación de notificar estas revisiones o modificaciones por adelantado o con posterioridad a su realización.

Los textos, imágenes e ilustraciones, y su presentación en este documento, están sujetos a la protección de copyright y otros derechos legales internacionales. Su uso, reproducción y transmisión a terceros sin permiso expreso por escrito puede dar lugar al inicio de procedimientos legales en los tribunales penales y civiles.

Aunque se han tomado todas las precauciones posibles en la compilación y presentación de la información de este documento, los datos en los que se basa pueden haber cambiado con el tiempo. snom, por lo tanto, renuncia a cualquier garantía y responsabilidad respecto a la precisión, exhaustividad y vigencia actual de la información publicada, excepto en el caso de intencionalidad o negligencia grave por parte de snom cuando se deriven responsabilidades de acuerdo con las disposiciones legales vinculantes.

Nuestro firmware incluye código fuente que puede ser usado y modificado por cualquier persona bajo la licencia pública GNU (GPL) (vease la página <?>), siempre que, a su vez, lo ponga a disposición de cualquier otra persona que tenga el mismo acuerdo de licencia. Acceda a <http://www.snom.com/de/support/download/gpl-quellcode/> para obtener la licencia GPL original y el código fuente de los componentes con licencia en virtud de la GPL y utilizados en productos snom.

Información importante

Lea las instrucciones sobre seguridad y reciclaje del teléfono, y sobre cómo configurar y utilizar el teléfono antes de usarlo, y ofrézcalas igualmente a otros usuarios para que las lean o se informen de su contenido. Conserve este manual y no entregue el teléfono a terceros sin el mismo.

Seguridad

Siga las instrucciones de este manual y cualquier otra documentación aplicable del dispositivo.

- Si la alimentación del teléfono no se realiza mediante/por Ethernet, use exclusivamente el adaptador de alimentación entregado con el teléfono o uno recomendado de forma expresa por snom. Otros adaptadores pueden dañar o incluso destruir el teléfono, afectar a su funcionamiento o provocar ruidos.
- Evite poner los cables de modo que otras personas puedan tropezar con el mismo. No coloque los cables de forma que pueda verse sometido a presiones mecánicas, ya que eso podría dañar los cables. Si el cable de alimentación o el enchufe están dañados, desconecte el teléfono y contacte con personal de servicio cualificado.
- Este dispositivo es solamente para uso en interiores.
- No instale el teléfono en lugares con humedad elevada (por ejemplo, en baños, lavaderos, o sótanos húmedos). No sumerja el teléfono en agua ni derrame o vierta líquidos de ningún tipo sobre el teléfono.
- No instale el teléfono cerca de lugares con riesgo de explosión (talleres de pintura, por ejemplo). No use el teléfono si huele a gas o a otros vapores que puedan ser explosivos.
- No use el teléfono durante una tormenta; los rayos que impacten en la red eléctrica pueden descargar eléctricas.

Cumplimiento de los requisitos SELV (Tensión Extra-Baja de Seguridad)

Las condiciones de seguridad de las conexiones de entrada/salida cumplen con los requisitos SELV.

Atención: Para evitar descargas eléctricas, no conecte circuitos de seguridad de tensión extra-baja (SELV) a circuitos de tensión de red telefónica (TNV). Los puertos LAN contienen circuitos SELV, los puertos contienen circuitos TNV. Algunos puertos LAN y PSTN utilizan conectores RJ-45 (8P8C). Tome precauciones cuando conecte los cables..

Cumplimiento con la normativa



Este teléfono tiene certificación CE y FCC, y cumple con los estándares de salud, seguridad y medioambientales europeos y de Estados Unidos.



La apertura, cambio, o modificación no autorizadas del teléfono provocarán que la garantía se cancele, y también pueden resultar en la cancelación de las certificaciones CE y FCC. En caso de avería, contacte con personal de servicio autorizado, su vendedor, o snom.

- Seguridad: IEC 60950-1:2005
- Certificados: FCC Class B, Indicación CE
- Consumo eléctrico: 2,5-7 W (sin unidades periféricas)
- 1 x LAN: RJ45 (Ethernet) 1 x 10/100 Mbps
- Alimentación: 5 V DC o PoE (Power over Ethernet) IEEE 802.3af, Clase 2
- Conectores USB: 2 x tipo A, 1 x tipo B

Eliminación



Este teléfono está sujeto a la Directriz Europea 2002/96/EC, y no se puede desechar con los residuos domésticos generales.

Si no sabe dónde reciclar el dispositivo cuando deje de funcionar, contacte con las autoridades municipales, con su proveedor de gestión de residuos local o con su vendedor.

Limpieza

Use una paño antiestático. No utilice agua ni productos de limpieza, ya que podrían dañar la superficie o los componentes electrónicos del aparato.

Inicialización y registro

Normalmente la inicialización es totalmente automática y se realiza a través del protocolo DHCP.

Si su red no admite DHCP, consulte la página 25.

Configuración

Abra el navegador de su PC. Teclee la dirección IP del snom Vision en la barra de direcciones (por ejemplo: <http://10.10.10.115>) y pulse Enter para abrir la interfaz web del snom Vision. Haga clic en "Extension Module" del menú de la izquierda. Introduzca los datos necesarios. Pulse  para guardar y pasar al siguiente campo.

Phone IP: Dirección IP del teléfono al que se conecta el módulo de ampliación

User & Password: El nombre de usuario y la contraseña para abrir el navegador web del teléfono en caso de que sea necesario

Identity for outgoing calls: Identidad para las llamadas salientes. Si no se indica ninguna identidad, se utilizará la identidad de salida del teléfono.

Image: Haga clic en la imagen para abrir la ventana para cargar un archivo de imagen o borrar la imagen actual

Value: Introduzca el número de extensión/ teléfono supletorio o de una línea externa

Name: Introduzca el nombre o número que se debe mostrar en la pantalla

Select image to upload: Introduzca la URL del fichero de imagen y haga clic en "Upload"

Delete Image: Haga clic en "Delete" para eliminar la imagen actual

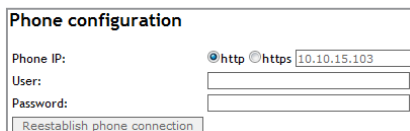

Phone configuration

Phone IP: http https

User:

Password:

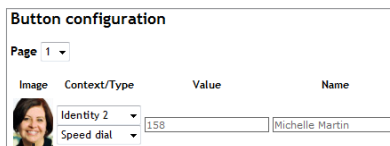

Button configuration

Page

Image	Context/Type	Value	Name
	Identity 2 Speed dial	158	Michelle Martin

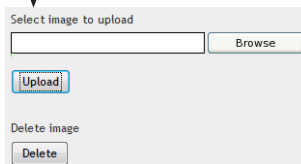

Select image to upload

Delete image

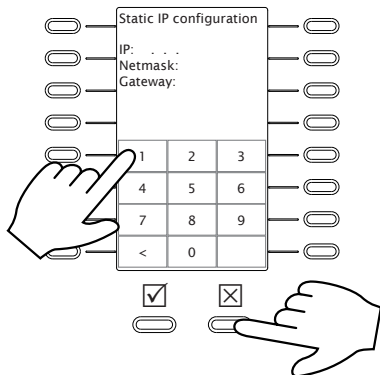



192.168.002.034

$$\overbrace{010.010.010.151}^{\uparrow \quad \uparrow \quad \uparrow \quad \uparrow}$$
192.168.2.34 \Rightarrow 192.168.002.03410.10.10.151 \Rightarrow 010.010.010.151

ENGLISH: Initializing and registering without DHCP



If your network does not support DHCP, you must obtain a static IP address, the netmask, and the IP gateway from your Internet service provider or your network administrator and enter them manually on the touchscreen.

- Delete character to the left of the cursor: 
- Delete all entries and start over: Press the  key

Enter IP address, netmask, and IP gateway. Press  when finished.

DEUTSCH: Initialisierung und Registrierung ohne DHCP

Falls Ihr Netzwerk DHCP nicht unterstützt, lassen Sie sich von Ihrem Netzwerkadministrator die IP-Adresse, die Netzmaske, und den IP-Gateway geben und tragen Sie sie manuell auf dem Touchscreen ein.

- Zeichen links vom Cursor löschen: 
- Alle Eingaben löschen und neu beginnen: Drücken Sie auf die Taste 

Geben Sie IP-Adresse, Netzmaske und IP-Gateway ein. Drücken Sie auf . wenn Sie alle Eingaben beendet haben.

FRANÇAIS: Initialisation et enrégistration sans DHCP

Si votre réseau ne supporte pas le protocole DHCP, vous devez également saisir l'adresse IP, le sous-réseau et la passerelle IP manuellement. Demandez-les de votre administrateur réseau et saisissez-les à l'écran tactile.

- Supprimer le caractère à la gauche du curseur:
- Supprimer tous les caractères et commencer de nouveau: Appuyez sur la touche

Saisissez l'adresse IP, le sous-réseau et la passerelle IP. Appuyez sur la touche .

ITALIANO: Inizializzazione e registrazione senza DHCP

Se la tua rete non supporta il DHCP, è necessario richiedere un indirizzo IP statico, la sottorete, il gateway predefinito all'amministratore di sistema o il tuo provider internet ed immettere tali dati manualmente tramite il display sensibile al tatto.

- Per cancellare il carattere a sinistra del cursore premi :
- Per annullare e reinserire i dati premi il tasto

Digitare l'indirizzo IP, la sottorete ed il gateway IP. Al termine premere il tasto .

ESPAÑOL: Inicialización y registro sin DHCP

Si su red no admite DHCP, deberá obtener una dirección IP estática, la máscara de red y la IP de la puerta de enlace de su proveedor de internet o su administrador de red e introducirlos manualmente en la pantalla táctil.

- Eliminar el carácter a la izquierda del cursor:
- Eliminar todos los caracteres y empezar de nuevo: Pulse la tecla

Teclee la dirección IP, la máscara de red y el IP de la puerta de enlace. Cuando finalice, pulse la tecla .

COPYRIGHT NOTICE AND WARRANTY DISCLAIMER

I.

Das Produkt enthält Software, die unter der GNU General Public License, Version 2, frei genutzt werden darf. This Product contains Software applicable to GNU General Public License, Version 2 which can be used freely.

II.

Im Verhältnis zu den Lizenzgebern der Software gilt der folgende Haftungsausschluss:
Towards the licensor of this Software the following liability is disclaimed:

This program is distributed in the hope that it will be useful, but WITHOUT ANY WARRANTY; without even the implied warranty of MERCHANTABILITY or FITNESS FOR A PARTICULAR PURPOSE. See the GNU General Public License for more details.

III.

Der Lizenztext der GPL lautet wie folgt:
The GNU General Public License is as follows:

GNU GENERAL PUBLIC LICENSE

Version 2, June 1991

Copyright (C) 1989, 1991 Free Software Foundation, Inc.
59 Temple Place, Suite 330, Boston, MA 02111-1307, USA

Everyone is permitted to copy and distribute verbatim copies of this license document, but changing it is not allowed.

Preamble

The licenses for most software are designed to take away your freedom to share and change it. By contrast, the GNU General Public License is intended to guarantee your freedom to share and change free software - to make sure the software is free for all its users. This General Public License applies to most of the Free Software Foundation's software and to any other program whose authors commit to using it. (Some other Free Software Foundation software is covered by the GNU Library General Public License instead.) You can apply it to your programs, too.

When we speak of free software, we are referring to freedom, not price. Our General Public Licenses are

designed to make sure that you have the freedom to distribute copies of free software (and charge for this service if you wish), that you receive source code or can get it if you want it, that you can change the software or use pieces of it in new free programs; and that you know you can do these things.

To protect your rights, we need to make restrictions that forbid anyone to deny you these rights or to ask you to surrender the rights. These restrictions translate to certain responsibilities for you if you distribute copies of the software, or if you modify it.

For example, if you distribute copies of such a program, whether gratis or for a fee, you must give the recipients all the rights that you have. You must make sure that they, too, receive or can get the source code. And you must show them these terms so they know their rights.

We protect your rights with two steps: (1) copyright the software, and (2) offer you this license which gives you legal permission to copy, distribute and/or modify the software.

Also, for each author's protection and ours, we want to make certain that everyone understands that there is no warranty for this free software. If the software is modified by someone else and passed on, we want its recipients to know that what they have is not the original, so that any problems introduced by others will not reflect on the original authors' reputations.

Finally, any free program is threatened constantly by software patents. We wish to avoid the danger that redistributors of a free program will individually obtain patent licenses, in effect making the program proprietary. To prevent this, we have made it clear that any patent must be licensed for everyone's free use or not licensed at all.

The precise terms and conditions for copying, distribution and modification follow.

GNU GENERAL PUBLIC LICENSE TERMS AND CONDITIONS FOR COPYING, DISTRIBUTION AND MODIFICATION

0. This License applies to any program or other work which contains a notice placed by the copyright holder saying it may be distributed under the terms of this General Public License. The „Program“, below, refers to any such program or work, and a „work based on the Program“ means either the Program or any derivative work under copyright law: that is to say, a work containing the Program or a portion of it, either verbatim or with modifications and/or translated into another language. (Hereinafter, translation is included without limitation in the term „modification“.) Each licensee is addressed as „you“.

Activities other than copying, distribution and modification are not covered by this License; they are outside its scope. The act of running the Program is not restricted, and the output from the Program is covered only if its contents constitute a work based on the Program (independent of having been made by running the Program). Whether that is true depends on what the Program does.

1. You may copy and distribute verbatim copies of the Program's source code as you receive it, in any medium, provided that you conspicuously and appropriately publish on each copy an appropriate copyright notice and disclaimer of warranty; keep intact all the notices that refer to this License and to the absence of any warranty; and give any other recipients of the Program a copy of this License along with the Program. You may charge a fee for the physical act of transferring a copy, and you may at your option offer warranty protection in exchange for a fee.

2. You may modify your copy or copies of the Program or any portion of it, thus forming a work based on the Program, and copy and distribute such modifications or work under the terms of Section 1 above, provided that you also meet all of these conditions:

a) You must cause the modified files to carry prominent notices stating that you changed the files and the date of any change.

b) You must cause any work that you distribute or publish, that in whole or in part contains or is derived from the Program or any part thereof, to be licensed as a whole at no charge to all third parties under the terms of this License.

c) If the modified program normally reads commands interactively when run, you must cause it, when started running for such interactive use in the most ordinary way, to print or display an announcement including an appropriate copyright notice and a notice that there is no warranty (or else, saying that you provide a warranty) and that users may redistribute the program under these conditions, and telling the user how to view a copy of this License. (Exception: if the Program itself is interactive but does not normally print such an announcement, your work based on the Program is not required to print an announcement.)

These requirements apply to the modified work as a whole. If identifiable sections of that work are not derived from the Program, and can be reasonably considered independent and separate works in themselves, then this License, and its terms, do not apply to those sections when you distribute them as separate works. But when you distribute the same sections as part of a whole which is a work based on the Program, the distribution of the whole must be on the terms of this License, whose permissions for other licensees extend to the entire whole, and thus to each and every part regardless of who wrote it.

Thus, it is not the intent of this section to claim rights or contest your rights to work written entirely by you; rather, the intent is to exercise the right to control the distribution of derivative or collective works based on the Program.

In addition, mere aggregation of another work not based on the Program with the Program (or with a work based on the Program) on a volume of a storage or distribution medium does not bring the other work under the scope of this License.

3. You may copy and distribute the Program (or a work based on it, under Section 2) in object code or executable form under the terms of Sections 1 and 2 above provided that you also do one of the following:

- a)** Accompany it with the complete corresponding machine-readable source code, which must be distributed under the terms of Sections 1 and 2 above on a medium customarily used for software interchange; or,
- b)** Accompany it with a written offer, valid for at least three years, to give any third party, for a charge no more than your cost of physically performing source distribution, a complete machine-readable copy of the corresponding source code, to be distributed under the terms of Sections 1 and 2 above on a medium customarily used for software interchange; or,
- c)** Accompany it with the information you received as to the offer to distribute corresponding source code. (This alternative is allowed only for noncommercial distribution and only if you received the program in object code or executable form with such an offer, in accord with Subsection b above.)

The source code for a work means the preferred form of the work for making modifications to it. For an executable work, complete source code means all the source code for all modules it contains, plus any associated interface definition files, plus the scripts used to control compilation and installation of the executable. However, as a special exception, the source code distributed need not include anything that is normally distributed (in either source or binary form) with the major components (compiler, kernel, and so on) of the operating system on which the executable runs, unless that component itself accompanies the executable.

If distribution of executable or object code is made by offering access to copy from a designated place, then offering equivalent access to copy the source code from the same place counts as distribution of the source code, even though third parties are not compelled to copy the source along with the object code.

- 4.** You may not copy, modify, sublicense, or distribute the Program except as expressly provided under this License. Any attempt otherwise to copy, modify, sublicense or distribute the Program is void, and will automatically terminate your rights under this License. However, parties who have received copies, or rights, from you under this License will not have their licenses terminated so long as such parties remain in full compliance.
- 5.** You are not required to accept this License, since you have not signed it. However, nothing else grants you permission to modify or distribute the Program or its derivative works. These actions are prohibited by law if you do not accept this License. Therefore, by modifying or distributing the Program (or any work based on the Program), you indicate your acceptance of this License to do so, and all its terms and conditions for copying, distributing or modifying the Program or works based on it.
- 6.** Each time you redistribute the Program (or any work based on the Program), the recipient automatically receives a license from the original licensor to copy, distribute or modify the Program subject to these terms and conditions. You may not impose any further restrictions on the recipients' exercise of the rights granted herein. You are not responsible for enforcing compliance by third parties to this License.
- 7.** If, as a consequence of a court judgment or allegation of patent infringement or for any other reason (not limited to patent issues), conditions are imposed on you (whether by court order, agreement or otherwise) that

contradict the conditions of this License, they do not excuse you from the conditions of this License. If you cannot distribute so as to satisfy simultaneously your obligations under this License and any other pertinent obligations, then as a consequence you may not distribute the Program at all. For example, if a patent license would not permit royalty-free redistribution of the Program by all those who receive copies directly or indirectly through you, then the only way you could satisfy both it and this License would be to refrain entirely from distribution of the Program.

If any portion of this section is held invalid or unenforceable under any particular circumstance, the balance of the section is intended to apply and the section as a whole is intended to apply in other circumstances.

It is not the purpose of this section to induce you to infringe any patents or other property right claims or to contest validity of any such claims; this section has the sole purpose of protecting the integrity of the free software distribution system, which is implemented by public license practices. Many people have made generous contributions to the wide range of software distributed through that system in reliance on consistent application of that system; it is up to the author/donor to decide if he or she is willing to distribute software through any other system and a licensee cannot impose that choice. This section is intended to make thoroughly clear what is believed to be a consequence of the rest of this License.

8. If the distribution and/or use of the Program is restricted in certain countries either by patents or by copyrighted interfaces, the original copyright holder who places the Program under this License may add an explicit geographical distribution limitation excluding those countries, so that distribution is permitted only in or among countries not thus excluded. In such case, this License incorporates the limitation as if written in the body of this License.

9. The Free Software Foundation may publish revised and/or new versions of the General Public License from time to time. Such new versions will be similar in spirit to the present version, but may differ in detail to address new problems or concerns.

Each version is given a distinguishing version number. If the Program specifies a version number of this License which applies to it and „any later version“, you have the option of following the terms and conditions either of that version or of any later version published by the Free Software Foundation. If the Program does not specify a version number of this License, you may choose any version ever published by the Free Software Foundation.

10. If you wish to incorporate parts of the Program into other free programs whose distribution conditions are different, write to the author to ask for permission. For software which is copyrighted by the Free Software Foundation, write to the Free Software Foundation; we sometimes make exceptions for this. Our decision will be guided by the two goals of preserving the free status of all derivatives of our free software and of promoting the sharing and reuse of software generally.

NO WARRANTY

11. BECAUSE THE PROGRAM IS LICENSED FREE OF CHARGE, THERE IS NO WARRANTY FOR THE PROGRAM, TO THE EXTENT PERMITTED BY APPLICABLE LAW. EXCEPT WHEN OTHERWISE STATED IN WRITING THE COPYRIGHT HOLDERS AND/OR OTHER PARTIES PROVIDE THE PROGRAM „AS IS“ WITHOUT WARRANTY OF ANY KIND, EITHER EXPRESSED OR IMPLIED, INCLUDING, BUT NOT LIMITED TO, THE IMPLIED WARRANTIES OF MERCHANTABILITY AND FITNESS FOR A PARTICULAR PURPOSE. THE ENTIRE RISK AS TO THE QUALITY AND PERFORMANCE OF THE PROGRAM IS WITH YOU. SHOULD THE PROGRAM PROVE DEFECTIVE, YOU ASSUME THE COST OF ALL NECESSARY SERVICING, REPAIR OR CORRECTION.

12. IN NO EVENT UNLESS REQUIRED BY APPLICABLE LAW OR AGREED TO IN WRITING WILL ANY COPYRIGHT HOLDER, OR ANY OTHER PARTY WHO MAY MODIFY AND/OR REDISTRIBUTE THE PROGRAM AS PERMITTED ABOVE, BE LIABLE TO YOU FOR DAMAGES, INCLUDING ANY GENERAL, SPECIAL, INCIDENTAL OR CONSEQUENTIAL DAMAGES ARISING OUT OF THE USE OR INABILITY TO USE THE PROGRAM (INCLUDING BUT NOT LIMITED TO LOSS OF DATA OR DATA BEING RENDERED INACCURATE OR LOSSES SUSTAINED BY YOU OR THIRD PARTIES OR A FAILURE OF THE PROGRAM TO OPERATE WITH ANY OTHER PROGRAMS), EVEN IF SUCH HOLDER OR OTHER PARTY HAS BEEN ADVISED OF THE POSSIBILITY OF SUCH DAMAGES.

END OF TERMS AND CONDITIONS

How to Apply These Terms to Your New Programs

If you develop a new program, and you want it to be of the greatest possible use to the public, the best way to achieve this is to make it free software which everyone can redistribute and change under these terms.

To do so, attach the following notices to the program. It is safest to attach them to the start of each source file to most effectively convey the exclusion of warranty; and each file should have at least the „copyright“ line and a pointer to where the full notice is found.

```
<one line to give the program's name and a brief idea of what it does>
Copyright (C) <year> <name of author>
```

This program is free software; you can redistribute it and/or modify it under the terms of the GNU General Public License as published by the Free Software Foundation; either version 2 of the License, or (at your option) any later version.

This program is distributed in the hope that it will be useful, but WITHOUT ANY WARRANTY; without even the implied warranty of MERCHANTABILITY or FITNESS FOR A PARTICULAR PURPOSE. See

the GNU General Public License for more details.

You should have received a copy of the GNU General Public License along with this program; if not, write to the Free Software Foundation, Inc., 59 Temple Place, Suite 330, Boston, MA 02111-1307 USA

IV.

Den vollständigen korrespondierenden Sourcecode der Software schickt Ihnen die snom technology AG auf Nachfrage gerne auf einem üblichen Datenträger gegen Erstattung der Herstellungskosten in Höhe von EUR 5,- zu.

Der vollständige korrespondierende Sourcecode kann auch über unsere Website unter http://www.snom.com/gpl_html?&L=0 herunter geladen werden.

If requested by you, the complete corresponding source code of the Software can be sent by snom technology AG on a standard data storage medium against the reimbursement of the manufacturing costs of EUR 5.- per unit.

The complete corresponding source code of the Software can also be downloaded from our web site http://www.snom.com/gpl_html?&L=0.

V.

Weitere Informationen finden Sie auch unter <http://www.snom.com>.

For further information see <http://www.snom.com>.

snom technology AG
Charlottenstr. 68-71
10117 Berlin, Deutschland
Tel. +49 30 39 83 3-0
Fax +49 30 39 83 31 11
info@snom.com, sales@snom.com

snom technology, Inc.
18 Commerce Way, Suite 6000
Woburn, MA 01801, USA
Tel. 781-569-2044
Fax 978-998-7883
infoUSA@snom.com

snom UK Ltd
Aspect Court
47 Park Square East
Leeds, LS12NL, UK
Tel. +44 1133 503 111
Fax +44 1133 503 110
uksales@snom.com, info@snom.com

snom France SARL
6 Parc des fontenelles
78870 Bailly, France
Tel. +33 1 80 87 62 87
Fax +33 1 80 87 62 88
info@snom.com, sales@snom.com

snom technology SRL
Via A. Lusardi 10
20122 Milano, Italia
Tel +39 02 00611212
Fax +39 02 93661864
info@snom.com, sales@snom.com

snom technology Ltd.
Rm. A2, 3F, No. 37, Ln. 258
Ruiguang Rd., Neihu Dist.
Taipei City 114, Taiwan
Tel +886-2-8751-1120
Fax +886-2-8751-1130
infoASIA@snom.com

**Your specialist retailer - Ihr Fachhändler -
Votre distributeur - Su distribuidor - Il tuo rivenditore:**

