



# User Guide

## BT RESPONSE 75



This product is intended for connection to analogue public switched telephone networks and private switchboards in the United Kingdom.

**Please open this page for an ‘at a glance’  
guide to your BT Response 75**

# At a glance

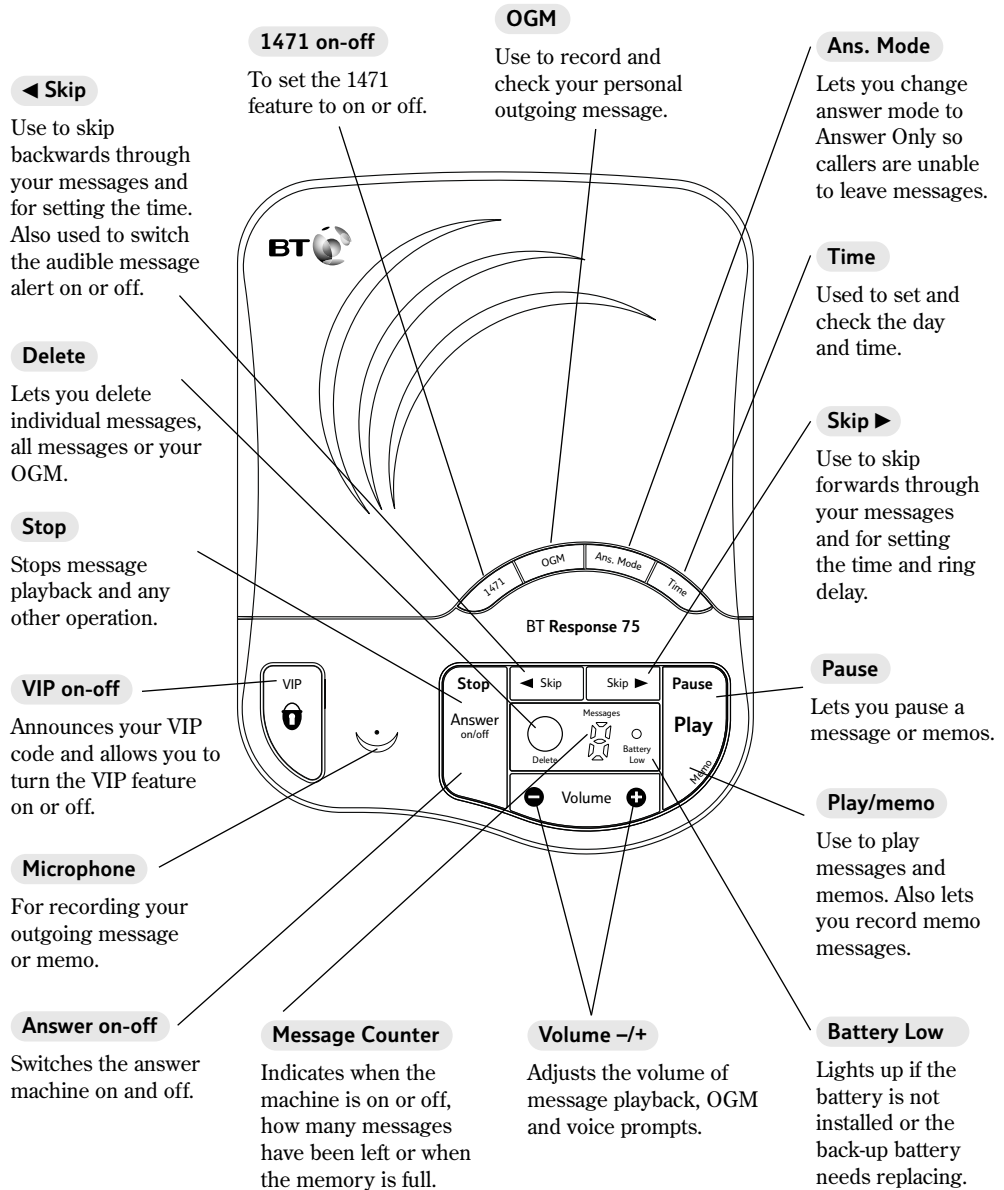

# Key features

## 36 minutes recording capacity

Offers the benefits of digital recording.

## Voice prompts

Helps you to follow instructions more easily.

## VIP feature

Sets your answering machine to answer calls silently but allows designated callers to alert you with a beep tone.

## Call return 1471

After each incoming message the machine will dial 1471 and record the announcement that gives you the telephone number of your caller whether they leave a message or not.

## Audible Message Alert

Audible message alert beeps to let you know when you have new messages. This can be switched on and off.

## Remote access

You can ring your BT Response 75 from another phone and switch it on or operate it to play back your messages.

## Time saver

You can set your BT Response 75 so that it will answer after 2 rings if messages have been left. If there are no new messages it will answer after 6 rings. During remote access this allows you to hang up before your BT Response 75 answers, therefore avoiding the cost of a call.

## Message counter

Allows you to see if the machine is on or off, how many messages have been left, or when the memory is full.

## Time & day stamp

Announces the time and day each message was received.

## Answer delay

Allows you to set the number of rings before calls are answered.

## 8 step electronic volume control

Lets you set the loudspeaker volume for message playback, outgoing message and voice prompts.

### Note

*On the underside of the unit you will find a quick reference guide which you can swing out, giving you instructions on some of the products most useful features.*

# *In this guide*

<b>At a glance</b>	<b>1</b>
<b>Key features</b>	<b>2</b>
<b>Introduction</b>	<b>4</b>
<b>Setting up</b>	<b>5</b>
<b>Safety instructions</b>	<b>8</b>
<b>Using your BT Response 75</b>	<b>9</b>
<i>Answering machine controls</i>	9
<i>Outgoing message</i>	11
<i>Receiving messages</i>	13
<i>Audible message alert</i>	14
<i>Call screening</i>	15
<i>VIP feature</i>	15
<i>1471 feature</i>	16
<b>Remote access</b>	<b>18</b>
<i>Your security code</i>	18
<i>Menu for remote access</i>	19
<b>Help</b>	<b>21</b>
<i>Guide to the display</i>	23
<b>General information</b>	<b>24</b>
<i>Guarantee</i>	24
<i>Technical information</i>	25
<i>Switchboard compatibility</i>	25
<b>Wall mounting template</b>	<b>27</b>
<b>Index</b>	<b>29</b>

# Introduction

Your BT Response 75 has been designed for ease of use and made to the high standards set by BT

You can expect your BT Response 75 to give you many years of trouble-free service.

Please read the instructions carefully before use and keep this User Guide for future reference.

## Unpacking your BT Response 75

If anything is missing, please contact your place of purchase immediately.

- BT Response 75 digital answering machine with telephone line cable attached.



- Plug mounted, 13 amp mains adaptor.

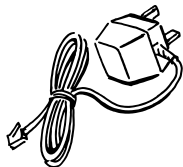

- Screws and wall plugs for wall mounting.



## For your records

Date of purchase:

Place of purchase:

Serial number (on the underside of the unit):

Purchase price:

For guarantee purposes, proof of purchase is required, so please keep your receipt.

Keep a reference of your Remote access Security Code here:

See 'Remote Access', page 18.

# Setting up

Follow these steps to set up your BT Response 75 ready for use

## Plan the location of your BT Response 75

Situate your BT Response 75 close enough to the phone and mains power sockets so that the cables will reach.

### 1 Check your telephone wall socket

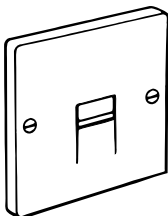

If you do not have a modern phone socket, call **Freephone 0800 800 150** and ask for a BT engineer to come and fit the correct socket.

This is a chargeable service.

### 2 Plug the mains power cord into the back of the machine

To prevent the mains cable being pulled out accidentally, place the cable behind the clip on the back of the unit.

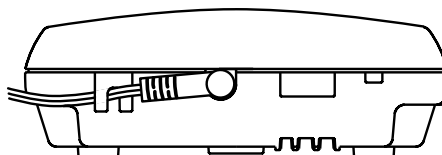

### 3 Plug the adaptor into a mains power socket

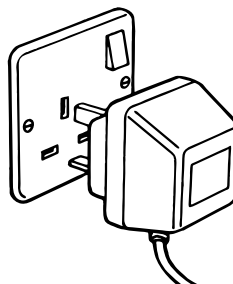

The display will flash for 38 seconds. It will then show the normal 'no messages' display. The display will flash slowly until any button is pressed.

**4 Insert the back-up battery**

Before inserting the back-up battery you must ensure that your unit is connected to the mains power.

The back-up battery (9V alkaline not supplied) ensures that all settings and messages are saved for up to six hours in the event of a power cut.

If the back-up battery runs out, or no battery is fitted, then in the event of a power failure your BT Response 75 will revert to its original settings and messages will be lost.

If the battery is low the “Battery Low” light will come on.

Insert a 9V alkaline battery into the battery compartment.

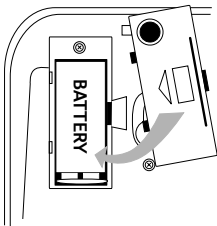

**Please note**

*Your BT Response 75 Plus battery low light, located beside the display, indicates back-up battery strength.*

*The LED will light up when the battery is low. It also remains lit when no back-up battery is inserted.*

**5 Plug your BT Response 75 into the telephone socket**

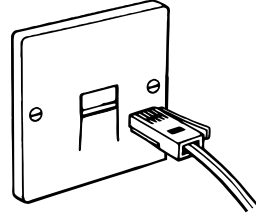

**6 You can now plug your telephone line cord into your BT Response 75**

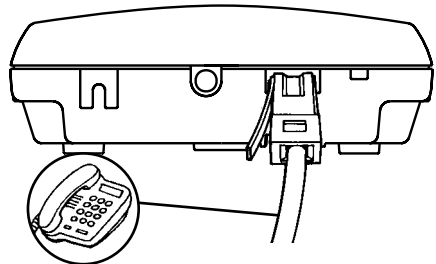

You will now be able to use your telephone as normal.

Your BT Response 75 is now ready to use.



**7 Wall mounting your  
BT Response 75**

Use the template on page 27 to drill holes in the wall. Leave a small gap between the screw heads and the wall.

Place your BT Response 75 over the screw heads and slide down.

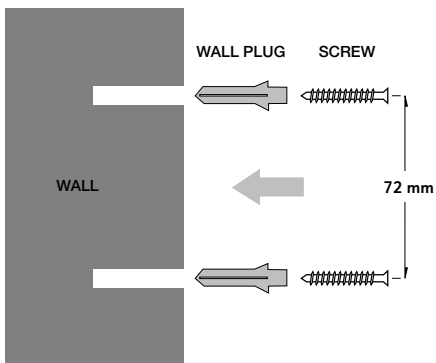

# *Safety instructions*

## General

- Simply clean your BT Response 75 with a damp (not wet) cloth, or an antistatic wipe. Never use household polish as this may damage the product. Never use a dry cloth as this may cause static shock.
- Only use the power supply included with the product. Using an unauthorised power supply unit will invalidate your guarantee and may damage the answer machine. The item number for the power supply unit is **872300**.
- Do not open the BT Response 75. This could expose you to high voltages or other risks.
- This product should not be used near emergency/intensive care medical equipment and should not be used by people with pacemakers.
- Never dispose of batteries in a fire. There is a serious risk of explosion and/or the release of highly toxic chemicals.

## Environmental

- Do not expose to direct sunlight.
- The product may heat up. This is normal. However, we recommend that you do not place the product on antique/veneered wood to avoid damage.
- Do not stand your product on carpets or other surfaces which generate fibres, or place it in locations preventing free flow of air over its surfaces.
- Do not submerge any part of your product in water and do not use it in damp or humid conditions, such as in bathrooms.
- Do not expose your product to fire, explosive or other hazardous conditions.
- There is a slight chance that your phone could be damaged by an electrical storm. We recommend that you unplug the power and telephone line cord for the duration of the storm as damage is not covered by the guarantee.

# Using your BT Response 75

## Answering machine controls

### To set the answering machine Mode-Answer on/off or Answer Only

You can switch your answering machine on and off or set it to Answer Only mode so callers are unable to leave messages.

*Press buttons in the order shown*

*To switch the answering machine on or off:*

Answer on/off

Press the **Answer on/off** button. You will hear “Answer on” or “Answer off”.

When off, the display shows a single dash.

When on, the display shows the number of messages received e.g 5.

Answer on/off

Press the **Answer on/off** button again to switch between on and off.

*To set the answering machine to Answer Only mode:*

Ans. mode

Press the **Ans. Mode** button.

You will hear “Answer Only on” and the display will show .

Callers will not be able to leave a message.

Ans. mode

If you press the **Ans. Mode** button again you will hear “Answer only off”. Your BT Response 75 will return to Answer On mode and display the number of messages received.

### To adjust the loudspeaker volume

The message playback volume can be set to a level suitable for you.

The original volume setting is 3 (mid-level).

Volume 

To increase the volume.

 Volume

To decrease the volume.

As you press, a beep sounds at the level you are selecting.

When the volume is at its highest or lowest level you will hear 2 beeps.

**Please note**

*If you alter the volume during playback of a message, the beep does not sound but the volume will change accordingly. If the volume is below mid-volume, it will automatically return to the mid-volume setting when any buttons are pressed (for example, if a message is played back). The volume is unaffected during remote access or call screening.*

**To set the time and day**

Your BT Response 75 will store the day and time an incoming message or memo was recorded. The BT Response 75 uses the 12 hour clock.

*To check the time:*

**Time**

Press and release the **Time** button, your BT Response 75 will announce the day and time in hours and minutes.

*To set the time:*

Press and hold down the **Time** button, your BT Response 75 announces the current day setting.

Whilst holding down the **TIME** button, press the **Skip▶** or **◀Skip** buttons to select the correct day.

When the day setting you require is announced, release the **Time** button.

**Time**

Press and hold down the **Time** button, your BT Response 75 announces the current hour setting.

**Skip▶****◀Skip**

Whilst holding down the **Time** button, press the **Skip▶** or **◀Skip** buttons to select the correct hour.

**Skip▶****◀Skip**

Press and hold the **Skip▶** or **◀Skip** buttons to move rapidly through the hour settings.

When the hour setting you require is announced, release the **Time** button.

**Time**

Press and hold down the **Time** button, your BT Response 75 announces the current minute setting.

**Skip▶****◀Skip**

Whilst holding down the **Time** button, press the **Skip▶** or **◀Skip** buttons to select the correct minutes.

**Skip▶****◀Skip**

Press and hold the **Skip▶** or **◀Skip** buttons to move rapidly through the minute settings.

When the minute setting you require is announced, release the **Time** button.

Your BT Response 75 will announce the full day and time.

**Please note**

*The time on your BT Response 75 is announced using the 12-hour clock. Be sure to hold down the ◀ or ▶ buttons long enough for your machine to say whether it is am or pm.*

## Outgoing message

The outgoing message is the message a caller hears when your BT Response 75 answers a call.

Your BT Response 75 comes with 2 pre-recorded outgoing messages. When set to Answer On your BT Response 75 will announce, *“Hello, your call cannot be taken at the moment, so please leave your message after the tone”*.

When set to Answer Only your BT Response 75 will announce, *“Hello, your call cannot be taken at the moment and you cannot leave a message, so please call later”* and they will not be able to leave a message.

You can use these outgoing messages or you may prefer to record your own.

### To record your own outgoing message

*Select the answer mode in which you want to record your own outgoing message:*

Answer  
on/off

Answer on/off

or

Ans. mode

Answer Only.

#### Please note

*Your outgoing message may sound something like this: ‘Hello, I’m sorry I can’t take your call at present. If you would like to leave a message, please speak after the tone.’*

Your 2 outgoing messages will be stored separately and the outgoing message played will depend on the mode you have selected.

#### Please note

*When set to Answer only, pressing the **Answer on/off** button will not function.*

OGM

You can record an outgoing message of up to 2 minutes long.

Press and hold the **OGM** button. Your BT Response 75 will beep and the display will show r.

Keep holding down the **OGM** button and record your message clearly about 15-30 cms from the microphone.

When you have finished recording, release the **OGM** button. You will hear a long beep and your message will be played back to you. You will then hear a long beep and your BT Response 75 will return to the answer mode selected.

To re-record your OGM repeat this procedure.

## To check your outgoing message

Select the Answer mode in which you want to check your OGM:

Answer  
on/off

Answer on/off

or

Ans. mode

Answer Only.

OGM

Press the **OGM** button.

Your outgoing message will be played back to you.

## To delete your outgoing message

You can delete either of your outgoing messages and return to one of the pre-recorded outgoing messages.

Ensure that you select the correct outgoing message that you want to delete. For example, if you want to delete the Answer Only outgoing message make sure your BT Response 75 is set to Answer Only first.

OGM

Press the **OGM** button.



Delete

During playback of your outgoing message press the **Delete** button.

Your OGM will stop playing, you will hear a short beep and your BT Response 75 will return back to the pre-recorded outgoing message

## Call counter

The counter will display the number of messages that have been recorded in the memory.

If you have received 10 or more messages the display will flash  to indicate this. Please see page 23 for a guide to the display.

## To set the answer delay

Your BT Response 75 is set to answer calls after 4 rings

You can change the number of rings before your BT Response 75 will answer a call. You have a choice of between 2-9 rings and Time Saver.

### Please note

*The Time Saver setting can avoid you the cost of a call when accessing your machine remotely from an external telephone.*

When set to Time Saver your BT Response 75 will answer after 6 rings if no new messages have been recorded, or 2 rings if new messages have been recorded (for more information on remote access, see page 18).

Skip ►

Press and hold the **Skip** ► button.

Your BT Response 75 announces the current ring delay and the message counter displays the selected answer delay setting.

Keep holding the **Skip▶** button. Your BT Response 75 announces and displays the answer delay options.

When you hear your desired setting, release the **Skip▶** button. After 2 seconds your BT Response 75 will announce the new answer delay setting and then return to 'Answer On' mode. The setting will be shown on the display.

### To check the answer delay setting

**Skip▶** Press the **Skip▶** button.

You BT Response 75 will announce the current ring delay setting and show the setting on the display.

### Receiving messages

After following the set-up procedure your BT Response 75 is ready to receive messages.

### To receive incoming messages

Your BT Response 75 will automatically record an incoming message when it is connected to your phone socket and is set to 'Answer On'.

When your BT Response 75 has received new messages (or memos) it will beep (*see 'Audible Message Alert to switch off'*) and the display will show the number of messages received. If you have more than 9 messages, the display will flash ☹.

#### Please note

*Two minutes is the maximum time allowed for each incoming message. If the maximum message length is reached, your BT Response 75 will announce, "Thank you for calling" and disconnect the line.*

If the memory is full then it will announce, *"Memory full, thank you for calling"* and disconnect the line.

Your BT Response 75 can record up to 30 messages and memos, within a total recording time of 36 minutes. If the memory capacity is full, the display will flash F and your answering machine will not record further messages.

## Audible message alert

Press and hold **◀Skip** to toggle between on and off.

You can stop your BT Response 75 from beeping to indicate new memos and messages have been left.

Press and hold **◀Skip** button. Your BT Response 75 announces “*Message Alert off*”.

To switch message alert on press and hold the **◀Skip** button again. Your BT Response 75 announces “*Message Alert On*”.

## To record a memo

You can use your BT Response 75 to record a memo which can be played back by another user.

A memo can be of any length, up to the maximum recording time available (36 minutes).



Press and hold the **Play/memo** button.

Your BT Response 75 will beep and the display flashes ‘r’.

Keep holding the **Play/memo** button and record your memo clearly, about 15-30 cms from the microphone.

To end the recording release the **Play/memo** button.

Your BT Response 75 stores memos and treats them in the same way as incoming messages.

## Please note

*To play back, delete or skip forward or backward through memos, follow the instructions for playing back messages (see below).*

## To playback messages and memos



Press the **Play/memo** button. Your BT Response 75 will announce “*You have X messages*”.

Messages and memos are announced and played back in the order they were received.

During message playback the message indicator shows the number of the message being played.  flashes if the message is number 10 or more.

**Skip▶**

Press the **Skip▶** button to skip forward to the beginning of the next message.

**Skip▶**

Press the **◀Skip** button once to return to the start of the current message or twice to go back to the previous message.

**Pause**

Press the **Pause** button to pause playback. The display will flash **P**. Press it again to resume playback.

When all your messages have been played, your BT Response 75 announces “*End of messages*” and the message indicator counts down from 8 to 0.



### To delete individual messages



Delete

During message playback press the **Delete** button.

Your BT Response 75 announces “*Message deleted*”.

By pressing the **Stop** button during the 8 second countdown at the end of all message play, the messages selected for deletion will be saved.

### To delete all messages



Delete

Wait until playback of all messages has finished and the message counter begins to count down from 8 to 0.

During this time, press the **Delete** button. Your BT Response 75 announces “*All messages deleted*”.

Stop

By pressing the **Stop** button during the 8 second countdown your messages will be saved.

### Call screening

You can let your BT Response 75 answer an incoming call and hear the caller’s voice through the loudspeaker so you can decide whether or not to take the call in person.

Make sure that the volume is set to an audible level and that the VIP feature is off.

Allow the incoming call to be answered by your BT Response 75 as normal. You will hear the caller begin to leave a message.

If you want to talk to the caller in person, pick up your handset and speak. Your BT Response 75 will automatically stop recording and reset to answer new calls.

### VIP feature

Your BT Response 75 has a VIP feature which sets your answering machine to answer calls silently (do not disturb) but allows designated VIP callers to alert you with a beep tone that they are trying to contact you. The VIP feature will only operate when the answering machine is set to ‘Answer On mode’.

### To switch VIP on and off

VIP is pre-set to OFF.



Answer on/off

Press and hold the **VIP** button, while still holding the **VIP** button, press the **Answer on/off** button. VIP will switch on.

Repeat the procedure to switch VIP off.

### To check the VIP code and setting

VIP



Press and *release* the **VIP** button. Your BT Response 75 will announce the 2 digit VIP code and tell you if the VIP setting is on or off.

### To allow VIP callers to alert you

KEYPAD

Give your VIP callers the VIP code. Your pre-set code is 40. Tell them to key in the code when they hear your outgoing message. VIP alert lasts for 30 seconds.

KEYPAD

If callers wish to cancel the alert, they press the **#** button on their phone. The unit will give a long beep at the end of the OGM, the caller can then leave a message after the beep.

### To change the VIP code

VIP



Press and *hold* the **VIP** button.

Skip▶

Keep holding **VIP** and press the **Skip▶** button to move forward through numbers, or press

◀Skip

◀**Skip** to move backward.

The VIP code numbers range from 00 to 59.

When you reach your desired code number, release the **VIP** button. Your BT Response 75 will announce the new VIP code.

### To stop the VIP alert beeps

KEYPAD

Press the **#** button. Your BT Response 75 will announce *“Please leave your message after the tone”*. Your caller can then leave you a message.

### 1471 feature

The 1471 feature is pre-set to on. After each incoming message your BT Response 75 is set to dial the free 1471 service and record the announcement that gives you the telephone number of your caller whether they leave a message or not. On playing back messages you will be given the caller's number and time of the call.

The display will show ‘c’ when dialling the 1471 service. The 1471 feature can be switched off.

### To switch the feature on/off

1471

Press the **1471** button.

Your BT Response 75 will announce *“1471 on/off”* as appropriate.

**Please note**

*The free 1471 service announces the day and time that the call was left. Your BT Response 75 will automatically record this announcement immediately after receiving a call. Consequently the day of the call will be recorded as 'today'. Therefore it is recommended that you check your messages on a daily basis. The free 1471 announcement also asks if you wish to return the call. In fact you are not able to do this.*

**To cancel any procedure****Stop**

Pressing the **Stop** button will cancel any procedure currently in progress.

After pressing the **Stop** button your BT Response 75 will return to 'Answer On' mode.

# Remote access

You can switch on and operate your answering machine from another TouchTone phone to play back your messages and memos

## Your security code

To keep your messages private, your BT Response 75 requires you to enter a 2-digit security code before you can play back your messages.

For your security code, look at the swing out label on the underside of the machine. (You cannot change the security code).

## To operate your BT Response 75 remotely

Dial your BT Response 75 phone number.

KEYPAD

When you hear your outgoing message, press the \* button. You will hear 2 beeps.

The message counter on your BT Response 75 will flash 'A'.

KEYPAD

Key in the first digit of your security code (within 8 seconds). You will hear a beep.

KEYPAD

Key in the second digit of your security code. You will hear a beep.

If you enter the incorrect code, your BT Response 75 will announce "Security code error."

*Please enter again*". If you enter the wrong code again, your BT Response 75 will announce "Security code error. Thank you for calling" and then end the call.

Once you have entered the correct security code, you can operate your BT Response 75 remotely.

If you have no messages, your BT Response 75 will announce "You have no messages" and wait for 8 seconds for you to enter another remote instruction.

If you have new messages, your BT Response 75 will announce "You have 'x' message(s)", and then play them back to you. See 'Menu for remote access', page 19 for more remote functions.

## To turn your BT Response 75 on

This is useful if you forgot to turn on your answering machine before going out.

Ring your BT Response 75. It will answer the call after 20 rings. When you hang-up, the answering machine will be switched on and will answer calls.

**Please note**

*If the memory is full, you will have to delete some messages before your BT Response 75 will switch to 'answer on' mode.*

*After you hear the 'memory full' announcement, you have 8 seconds to enter your security code. You can then delete messages, see 'To delete messages', page 19.*

**Menu for remote access**

You can now playback, and access various other remote functions using the phones keypad, as follows:

**To repeat current message**

During message playback:

**KEYPAD** Press the **4** button.

**To replay all messages**

When you hear "End of messages", within 8 seconds,

**KEYPAD** press **2** on your keypad.

**To skip backwards to the previous message**

During message playback:

**KEYPAD** Press the **4** button twice to skip back to the previous message, or three times to move back 2 messages, etc.

**To skip forwards to the next message**

During message playback:

**KEYPAD** Press the **6** button.

You can move forward two messages by pressing the **6** button twice, move forward 3 messages by pressing it 3 times, and so on.

**To delete the current message**

During message playback:

**KEYPAD** Press the **5** button.

Your BT Response 75 will announce "Message deleted".

**To delete all messages**

When you hear "End of messages", within 8 seconds, press **5** on your keypad.

**KEYPAD**

Your BT Response 75 will announce "All messages deleted".

**To stop/cancel a command**

During message playback:

**KEYPAD** Press the **0** button. Your BT Response 75 will give 2 beeps.

### To pause a message

During message playback:

**KEYPAD** Press the **2** button. You will hear a beep every 10 seconds.

**KEYPAD** Press **2** again to resume playback.

If you pause for longer than 60 seconds, the line will be disconnected.

### To switch your answering machine on/off

When you hear “*End of messages*” or “*You have no messages*”, within 8 seconds, press **8** on your keypad.

**KEYPAD**

Your BT Response 75 answering machine will switch off and announce “*Answer off*”.

**KEYPAD** Press the **8** button again within 8 seconds, to switch back on again. Your BT Response 75 will announce “*Answer On*”.

### To switch between Answer Record and Answer Only mode

When you hear “*End of messages*”. Within 8 seconds, press **3** your BT Response 75 will announce “*Answer Only on*” or “*Answer Only off*”.

**KEYPAD**

**KEYPAD** Press **3** again to change the setting.

### To change your outgoing message

When you hear “*End of messages*” or “*You have no messages*”, within 8 seconds, press **7** twice.

**KEYPAD**

Your BT Response 75 will beep to let you know it is starting to record.

When you have finished recording your new outgoing message, press and hold the **0** button for 1 second.

**KEYPAD**

Your BT Response 75 will beep and play back your message.

To retrieve the default announcement, press **5** during playback of your message.

**KEYPAD**

### To check your outgoing message

When you hear “*End of messages*” or “*You have no messages*”, within 8 seconds, press **9** on the keypad.

**KEYPAD**

Your BT Response 75 will play back your message.

# Help

If you have any problems using your BT Response 75, this section gives you the most common solutions

## **Call counter does not light up**

Check that your BT Response 75 is correctly connected to the mains and that the power cable is inserted correctly into the back of your BT Response 75.

If you have inserted the back-up battery before connecting to the mains power you will need to reset your BT Response 75.

## **No dialling tone**

Check your line cord is correctly connected to the socket and your BT Response 75.

## **BT Response 75 display is flashing continuously**

This indicates an error. Press any button on your answering machine. Flashing should stop and the answering machine should reset to its settings on first 'power up'. Unplug the line cord and power cord. Wait 5 minutes and then replug.

Press the **Answer on/off** button on your answering machine. Flashing should stop and BT Response 75 should reset to settings on first 'power up'.

## **BT Response 75's battery low indicator is on**

The back-up battery is either low in power, missing or incorrectly installed. Open the battery compartment. If battery is correctly in place, try replacing it with a new 9V alkaline battery. When operating at normal power the battery light remains off.

## **Incoming message does not record**

Make sure your BT Response 75 is set to answer-on mode and that the memory is not full. When the memory is full, the display will flash F.

## **You cannot hear messages or incoming calls**

Your BT Response 75's volume may be set too low. Adjust the volume by pressing **+** on the volume control.

## **You experience a power cut**

If a working battery is installed inside your BT Response 75, its settings and messages should be saved until power resumes. It will not be able to record any new messages, however.

### **You cannot access remotely**

Make sure that the telephone you are using to access your BT Response 75 has a *TouchTone*™ keypad.

When entering your code, make sure you allow enough time, at least 2 seconds, between digits for your BT Response 75 to recognise each one.

### **VIP function does not respond**

Make sure that VIP is switched on. See *'To switch VIP on or off'*, page 15.

### **To reset**

If you encounter a problem and your BT Response 75 will not respond to any button presses, remove the battery then turn off the power for 10 seconds. Turning the power back on will reset your BT Response 75 to 'Answer-On' mode.

Ensure that your BT Response 75 is connected to the mains power before you insert the back-up battery.

All messages will be lost when resetting your BT Response 75.

### **Buzzing noise on answer machine**

Your answering machine is too close to a radio, TV, computer, cordless or mobile telephone, causing interference. Move it another metre away.

### **Clicking from answer machine**

In some instances, when the **1471** feature is switched on, you may hear a series of quiet clicks. This is normal operation.

### **No OGM**

You may have accidentally pressed the **OGM** button for too long when checking your outgoing message, and recorded a short silent outgoing message. Re-record your outgoing message, which will allow you to delete it if you wish, or re-instate the pre-recorded outgoing message.

### **BT accessories and replacement items**

For a full range of accessories and replacement items for BT products please call 0870 240 5522, or visit:





## Guide to the display

BT Response 75	Message counter display shows
Power off	
Power up or reset (about 8 seconds)	☰ (flashing)
Power on – answer-off mode	—
Answer-on mode –no messages – after reset	(flashing slowly), then 1 to 9 (according to number of messages recorded following reset) until a button is pressed.
Answer-on mode, 0-9 messages – normal use	0 to 9
Answer-on mode, more than 9 messages	9 (flashing)
Answer only outgoing message	☎
Message paused	P (flashing)
Audible message Alert ON	☑
Audible message Alert OFF	☒
Message recording (memo, outgoing message or incoming message)	r (flashing)
Remote access in progress	Ⓜ (flashing)
Memory full	F (flashing rapidly)
Setting or reading Answer delay	t or 2 to 9
1471 function in progress	Ⓢ (flashing)
Error	E (flashing rapidly)

# General information

## Guarantee

Your BT Response 75 is guaranteed for a period of 12 months from the date of purchase.

Subject to the terms listed below the guarantee will provide for the repair of, or at BT's or its agent's discretion the option to replace the BT Response 75, or any component thereof, (other than batteries), which is identified as faulty or below standard, or as a result of inferior workmanship or materials. Products over 28 days old from the date of purchase may be replaced with a refurbished or repaired product.

The conditions of this guarantee are:

- The guarantee shall only apply to defects that occur within the 12 month guarantee period.
- Proof of purchase is provided.
- The equipment is returned to BT or its agent as instructed.
- This guarantee does not cover any faults or defects caused by accidents, misuse, fair wear and tear, neglect, tampering with the equipment, or any attempt at adjustment or repair other than through approved agents.
- This guarantee does not affect your statutory rights.

### **Within the 12 month guarantee period:**

If you experience difficulty using the product, prior to returning your product, please read the Help section beginning on page 21.

In the unlikely event of a defect occurring, please return the product, with the receipt, to the place of purchase.

### **Outside of the 12 month guarantee period:**

If your product needs repair after the guarantee period has ended, the repair must meet the approval requirements for connection to the telephone network. We recommend that you contact BT's approved repair agent, TecLogic on **01672 564444** or a local qualified repairer.

### **If you have to return your BT Response 75**

Pack the unit securely, preferably in the original packaging. All parts must be returned including the mains power adaptor. We cannot take responsibility for goods damaged in transit.

## Technical information

### How many telephones can you have?

All items of telephone equipment have a Ringer Equivalence Number (REN), which is used to calculate the number of items which may be connected to any one telephone line. Your BT Response 75 Plus has a REN of 1. A total REN of 4 is allowed, if the total REN of 4 is exceeded, the telephones may not ring. With different telephone types there is no guarantee of ringing, even when the REN is less than 4.

Only use approved power supply, item code 872300.

This equipment complies with the essential requirements of the Radio Equipment and Telecommunications Terminal Equipment Directive, 1999/5/E.

## Switchboard compatibility

This product is intended for use within the UK for connection to the public telephone network and compatible switchboards, which support tone dialling and time break recall. If in doubt please consult your service provider.

## Connection information

The BT Response 75 is intended to be connected to analogue networks and private switching systems in the United Kingdom.

It may also be connected to switching systems that use tone (MF) or pulse (LD) signalling, with earth or timed break recall. If in doubt, your switch supplier or maintainer should be able to offer help. Advice on connection to BT switching systems can be obtained by dialling BT Freefone **0800 800 152**.

If you do not have a compatible switchboard, it cannot be guaranteed that your BT Response 75 will operate correctly under all possible conditions of connection.

### Please note

*1471 feature will not work on a switchboard.*

Generally your BT Response 75 can be connected to any switchboard where a simple modern telephone can be used to make and receive calls. It cannot be used to answer calls on PBXs configured for dial 8 night service unless a suitable adaptor is purchased (not available from BT).

## **If the power fails**

If the battery warning light was not lit before the power was lost, all information should be retained for at least one hour (up to 6 hours for a fresh alkaline battery).

If the light was on, data may be lost even if a back-up battery was installed.

If no battery was installed, all information will be lost and the BT Response 75 will power up as new when power is restored.

## Wall mounting template

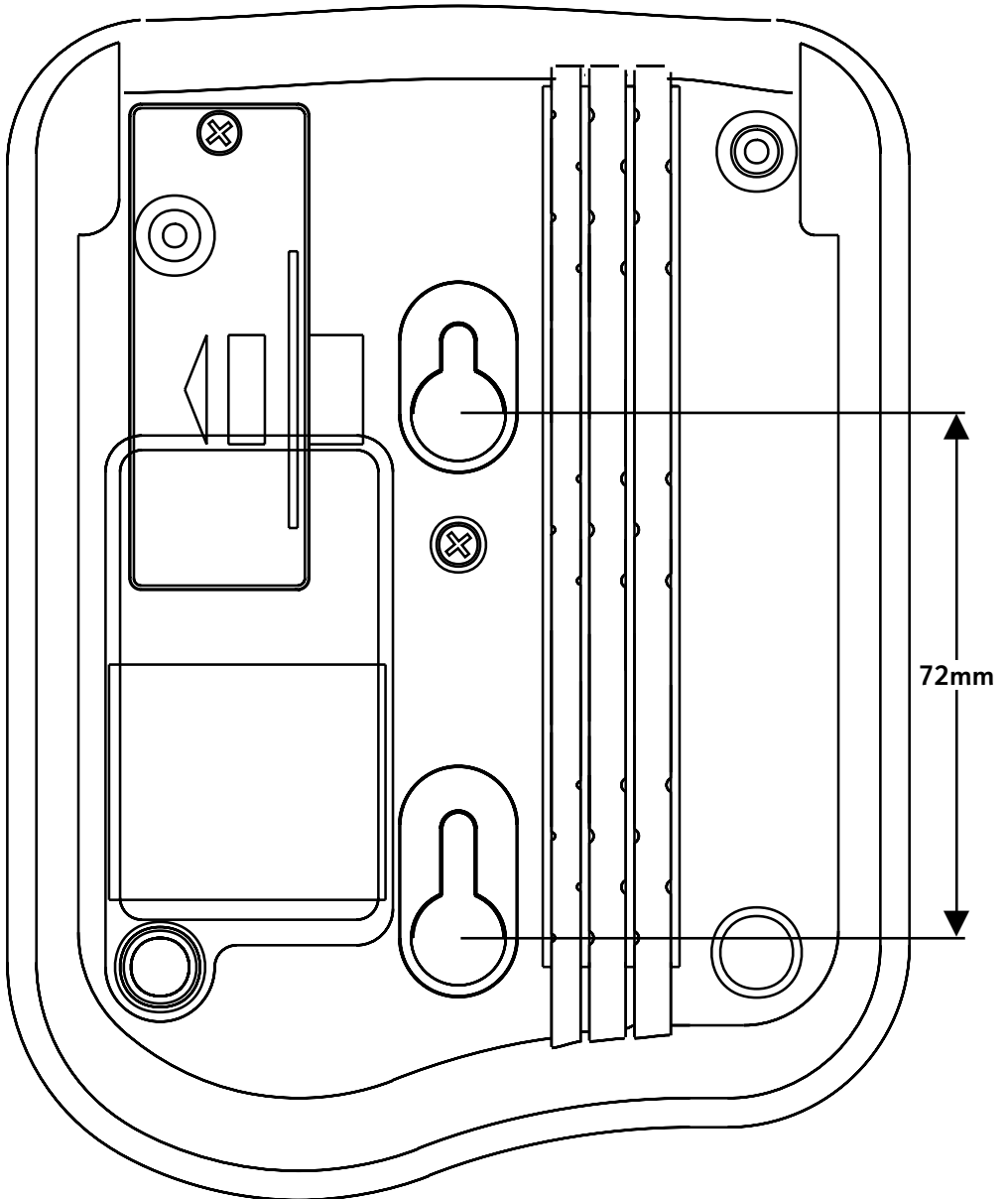



# Index

1471 feature	16	answering machine	9
<b>A</b> nswer delay	12	VIP	15
<b>A</b> nswering machine		<b>O</b> utgoing messages	11
answer only	9	check your outgoing message	12
loudspeaker volume	9	delete your outgoing message	12
on/off	9	record your outgoing message	11
outgoing message	11	<b>P</b> layback	14
playback	14	<b>R</b> eceiving messages	13
receiving messages	13	<b>R</b> ecord	
<b>A</b> udible message alert	14	memo	14
<b>B</b> attery	6	outgoing message	11
<b>C</b> all screening	15	<b>R</b> emote access	18
<b>C</b> all counter	12	menu	19
<b>D</b> elete		operate answering machine	18
all messages	15	security code	18
individual messages	14	<b>R</b> eturning your BT Response 75	24
outgoing message	12	<b>R</b> inger Equivalence Number	25
<b>D</b> isplay guide	23	<b>S</b> afety instructions	8
<b>G</b> uarantee	24	<b>S</b> ecurity code	18
<b>H</b> elp	21	<b>S</b> etting up	5
<b>M</b> ains power cord	5	<b>S</b> witchboard compatibility	25
<b>M</b> essages		<b>T</b> echnical information	25
memos	14	<b>T</b> elephone line socket	5
outgoing	11	<b>T</b> ime and day setting	10
playback	14	<b>V</b> IP feature	15
<b>N</b> umber of rings	12	<b>V</b> olume loudspeaker	9
<b>O</b> n/Off		<b>W</b> all mounting	7
1471	16	<b>W</b> all mounting template	27

Visit us at [www.bt.com](http://www.bt.com)



## Offices worldwide

The telecommunications services described in this publication are subject to availability and may be modified from time to time. Services and equipment are provided subject to British Telecommunications plc's respective standard conditions of contract. Nothing in this publication forms any part of any contract.

*Touchtone*<sup>™</sup> is a registered trade mark of British Telecommunications plc in the UK.

© British Telecommunications plc 2003.  
Registered Office: 81 Newgate Street, London EC1A 7AJ.  
Registered in England No. 1800000.  
Designed by: The Art & Design Partnership Limited.  
Printed in China. BT Response 75. Issue 2 (10/03) 1

