



# BT Diverse 7410 Plus User Guide



Bringing it all together



This new interactive user guide lets you navigate easily through the pages and allows you to be directed straight to any websites or email addresses that are referenced.

Simply hover the cursor over the page number, website or email reference and click when the  icon changes to the .



Think before  
you print!

This User Guide provides you with all the information you need to get the most from your phone.

Before you make your first call you will need to set up your phone. Follow the simple instructions in 'Getting Started', on the next few pages or refer to the quick set-up guide enclosed in the box if you haven't already done so.

### Need help?

If you have any problems setting up or using your BT Diverse 7410 Plus please call the Helpline on 0800 218 2182\* or visit [www.bt.com/producthelp](http://www.bt.com/producthelp). Our dedicated advisors are more likely to be able to help you than the retailer where you made your purchase.

Alternatively, you may find the answer in the 'Help' section at the back of this guide.

### IMPORTANT

Only use the power adaptor and telephone line cord supplied, or this product may not work.

### Hearing aid?

Please note that the BT Diverse 7410 Plus works by sending radio signals between the base and handset. These signals may interfere with some hearing aids, causing a humming noise.

### Got everything?

- BT Diverse 7410 Plus handset
- BT Diverse 7410 Plus base
- 2 x NiMH AAA rechargeable batteries (already fitted)
- Power adaptor (item code 048610)
- Telephone line cord
- Base plinth (already attached)

\* Calls to the Helpline made from within the UK mainland network are free. Mobile and International call costs may vary.

# In this guide

## Getting started

Location	6
Setting up	6
Set date and time manually	7

## Getting to know your phone

Handset buttons	8
Handset display / display icons	9
Base	10
Navigating the menus	11
Menu map	12

## Using the phone

Switch handset on or off	13
Make an external call	13
Preparatory dialling	13
End a call	13
Receive a call	13
Earpiece / handsfree volume	13
Call Waiting	14
Secrecy	14
Handsfree	14
Make a handsfree call	14
Answer a call handsfree	15
Switch to handsfree during a call	15
Headset	15
Redial the last number called	15

Redial a number from the redial list	16
Save a number from the redial list to the phonebook	16
Delete a redial number	16
Delete all redial numbers	16
Keypad lock	17
Find handset (paging)	17

## Phonebook

Store a name and number in the phonebook	18
View an entry in the phonebook	18
View phonebook capacity	18
Dial an entry in the phonebook	19
Edit a name and number in the phonebook	19
Copy an entry from the phonebook to another handset	19
Copy all phonebook entries to another handset	20
Delete an entry in the phonebook	20
Delete entire phonebook	20
Edit call group name	21
Change call group ringtone	21
Speed Dial	22
Copy a phonebook entry to a Speed Dial button	22
Delete a Speed Dial entry	22
Edit a Speed Dial entry	23
Dial a Speed Dial entry	23

## Sounds

Handset ringer melody (for external or internal calls)	24
Handset ringer volume (including ringer off)	24
Set to quiet mode	24
Handset beeps	24

## Settings

Select base	25
Display contrast / Handset name	25
Auto answer	25
De-register a handset	26
Handset reset	26
Base ringer melody and volume	26
Handset ringing priority	27
Recall mode	27
Repeater mode	27
System PIN	27
PBX access code	28
Reset base	28
Date / Time / Alarm	28
Set date and time	28
Set alarm call	29
Stop alarm ring	29

## Calls list

Caller Display	30
Calls list	30
View call details	30
Dial from the Calls list	31

Copy a Calls list number to the phonebook	31
Calls list settings: Calls list type and New Call alert	31
Delete an entry in the Calls list	32
Delete entire Calls list	32
Voicemail	32

## BT Network services

Pre-stored BT Services numbers	33
BT Diverse 7410 Plus Helpdesk	33
BT 118 500 (Directory Enquires)	33
Call Divert on/off/check	33
Call Waiting on/off/check	33
Show/Edit/Delete BT Services numbers	34

## Text messaging (SMS)

Subscribe to the text messaging service	35
Cost of the fixed line service	35
Send a text message	35
View messages in the Outbox	36
Using the Draftbox	37
Receiving messages	37
Read messages	37
Edit or delete templates	38
Service Centre numbers	38
Add or change Service Centre numbers	39
Select Send Service Centre	39
Message alert	39
Switch new text message alert on or off	39

## Using additional handsets

Easy registration of a new additional Diverse handset	40
Registration of an additional handset when base PIN changed	41
Internal calls	41
Call another handset	41
Transfer a call	42
3-way conference call	42

<b>Help</b>	43
-------------	----

## General information

Replacing the handset batteries	49
Replacing the base plinth	49
Safety information	50
Cleaning	50
Environmental	51
Product disposal instructions	51
Guarantee	51
Technical information	53
R&TTE	53
Declaration of Conformance	53
Connecting to a switchboard	53
Inserting a pause	53
Recall	53

# Getting started

## Location

Place your BT Diverse 7410 Plus within 2 metres of the power socket and telephone socket so that the cables will reach. Make sure it is at least 1 metre away from other electrical appliances to avoid interference.

Your BT Diverse 7410 Plus works by sending radio signals between the handset and base. The strength of the signal depends on where you site the base. Putting it as high as possible ensures the best signal.

## Setting up

1. Plug the power cable into the socket marked  on the underside of the base and plug the other end into the power wall socket and switch the power on. You can place the cable behind the retaining clip to prevent the plug being accidentally pulled from the socket.

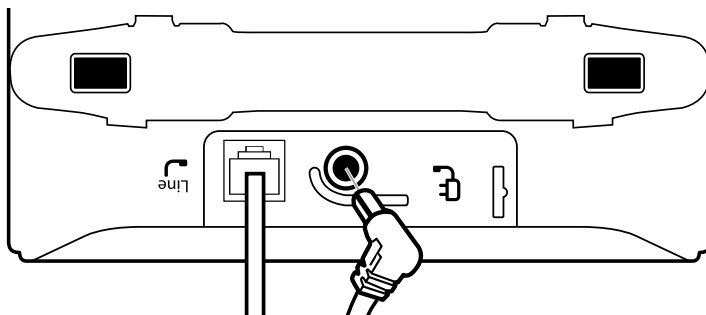

2. Batteries will come inserted in the battery compartment. Remove the protective film from the handset screen and activate the batteries by pulling the plastic tab away from the back of the handset.

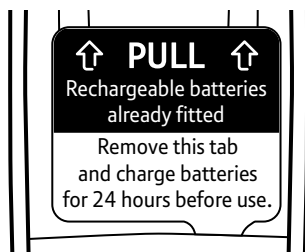

### WARNING

Do not place your BT Diverse 7410 Plus in the bathroom or other humid areas.

### Handset range

The BT Diverse 7410 Plus has a range of up to 300 metres outdoors when there is a clear line of sight between the base and handset. Any obstruction between the base and handset will reduce the range significantly. With the base indoors and handset either indoors or outdoors, the range will normally be up to 50 metres. Thick stone walls can severely affect the range.



### Signal strength

The  icon on your handset indicates when you are in range. If moving out of range of the base, the range indicator will flash. If you go out of range, any call you are on will be lost.

### IMPORTANT

The base station must be plugged into the power socket at all times. Do not connect the telephone line to the telephone wall socket until the handset is fully charged. Only use the power and telephone cables supplied with the product.

### Battery low warning













If the  icon flashes in the handset display you will need to recharge the handset before you can use it again. You also hear a low battery warning beep once every 60 seconds. During charging, the  icon will scroll in the display as shown on page 9.

- Place the handset on the base to charge for at least 24 hours.
- When the batteries are fully charged, plug the end of the telephone line cord into the telephone wall socket.

## Set date and time manually

Providing you have subscribed to your network's Caller Display service, the date and time is set automatically when you receive your first call.

To set the date and time manually, follow the procedure below.

- Press the right soft key  (Menu) and scroll  to Settings and press the right soft key  (OK).
- Date & Time is highlighted. Press OK.
- Time Format is highlighted. Press OK. Scroll  or  to choose how you want the clock displayed, either 24 Hour or 12 Hour. Press OK.
- Scroll  to Date Format and press OK. Scroll  or  to choose DD/MM/YYYY or MM/DD/YYYY. Press OK.
- Scroll  to Enter Time and press OK. Enter the time using the keypad as either the 24 hour format or 12 hour format (previously selected) e.g. 17:30 or 05.30 for 5.30pm. If 12 hour was chosen, press  or  to select AM or PM. Press OK.
- Scroll  to Enter Date and press OK. Enter the date, e.g. 09 04 2011 (displayed as 09/04/2011) for 9th April 2011. Press OK.
- Press  to return to the standby screen.

## Your BT Diverse 7410 Plus is ready for use.

### Battery performance

In ideal conditions, a fully charged battery should give up to 12 hours talk time or 180 hours standby time on a single charge.

Note that new batteries do not reach full capacity until they have been in normal use for several days.

The charge capacity of rechargeable batteries will reduce with time as they wear out, giving the handset less talk/standby time. Eventually they will need to be replaced. New rechargeable batteries are available from the BT Diverse 7410 Plus Helpline on 0800 218 2182\*.

After charging your handset for the first time, subsequent charging time is about 6–8 hours a day depending on usage. Batteries and handset may become warm during charging. This is normal.

### Using your BT Diverse 7410 Plus on a Broadband line?

If this product is to be used on a broadband line then you must ensure that it is connected via an ADSL microfilter. Using this product on a Broadband line without an ADSL microfilter may cause problems with this product and your Broadband service.

Additional BT ADSL microfilters can be purchased from [www.shop.bt.com](http://www.shop.bt.com)

# Getting to know your phone

## Handset buttons

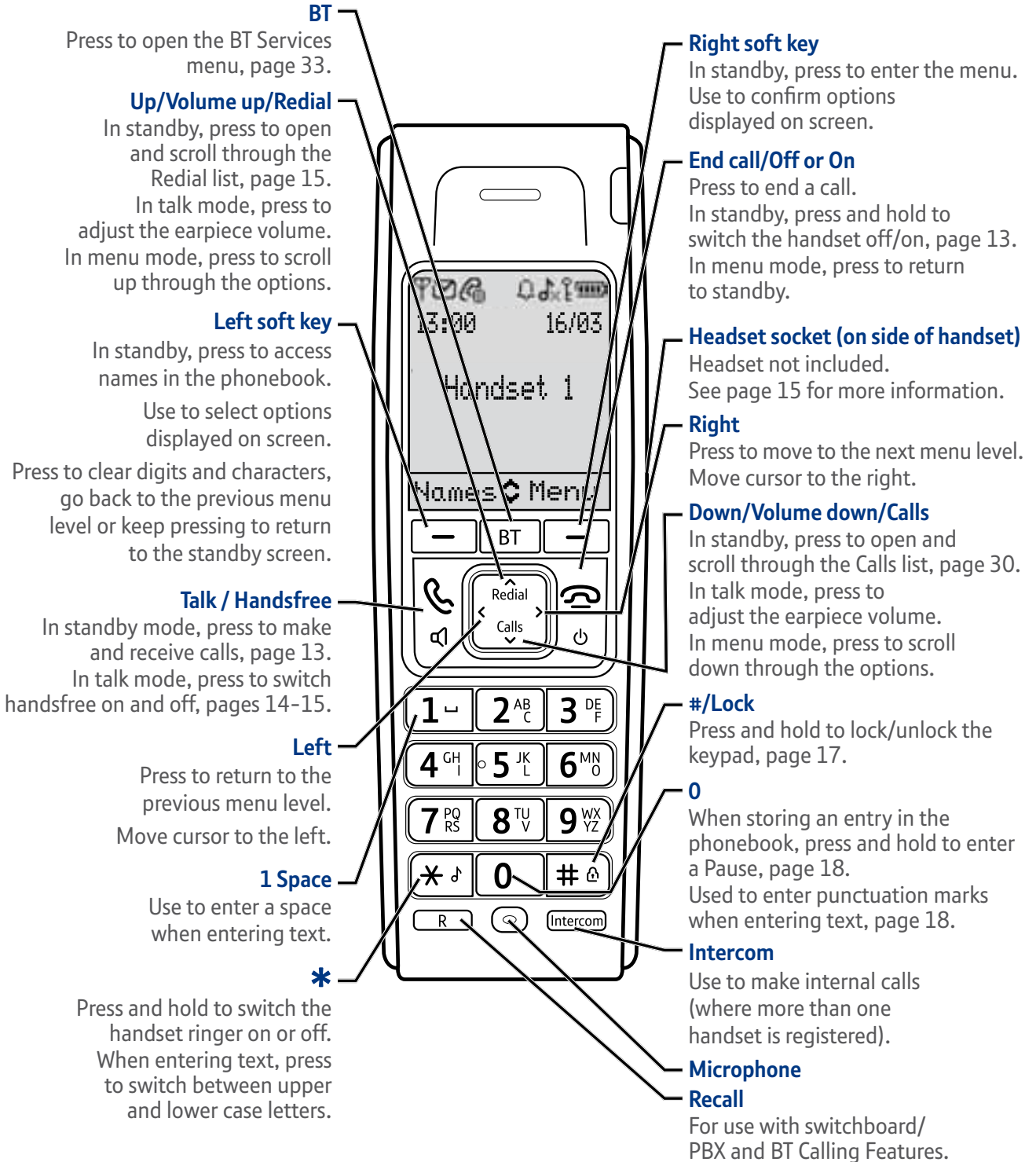





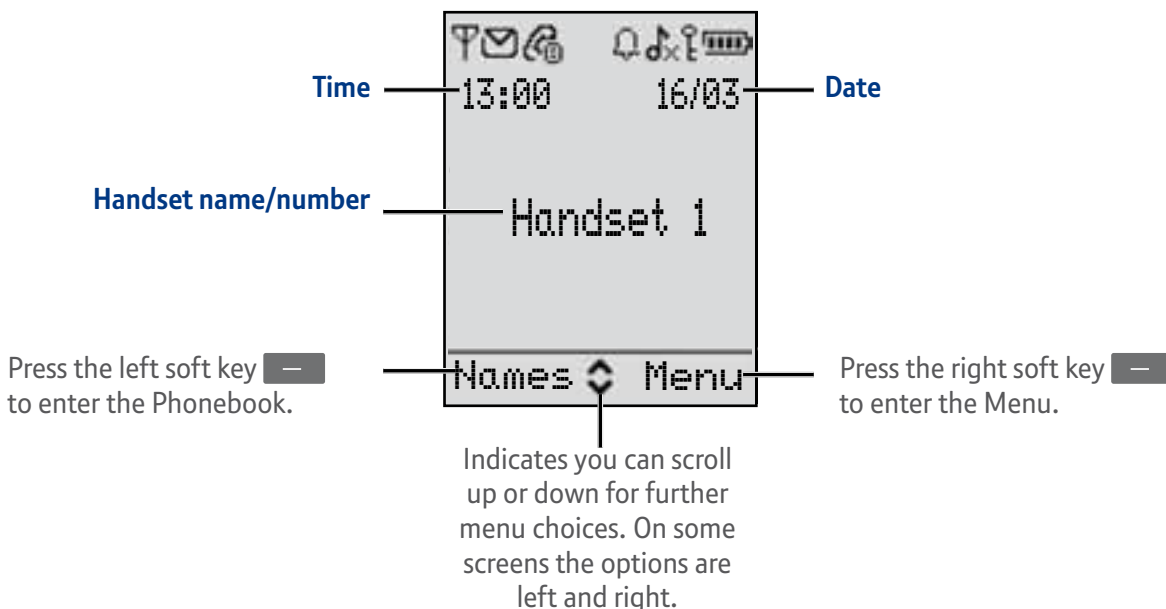









## Handset display



## Display icons

- |   |   |
|---|---|
| <p> On – displayed in standby mode to indicate handset is in range of the base.<br/>Flashing – to warn you are moving out of range.<br/>Off – out of range or cannot connect to the base selected.</p> | <p> On – alarm is set.<br/>Flash – alarm time has been reached.<br/>Off – alarm off.</p>   |
| <p> On – new text message received.*<br/>Flashing – mailbox is full.<br/>Off – any messages have been read.</p>  | <p> Handset ringer is switched off.</p>  |
| <p> On – during a call.<br/>Flashing – incoming call.</p>  | <p> The keypad is locked.</p>  |
| <p> On – missed call in the Calls list.*<br/>To remove the icon you need to view missed calls. See Caller Display, page 30.</p>  | <p> Battery fully charged.<br/> Battery is ¾ charged.<br/> Battery is ½ charged.<br/> Battery is ¼ charged.<br/> Empty. Icon will flash.<br/>Please note: battery scrolls between empty and fully charged when charging.</p> |
|   | <p> On – handsfree speaker on.</p>   |

\* For this feature to work you must subscribe to your network provider's Caller Display service. A fee may be payable.

## Base

### Find

Press and release to ring all registered handsets, helpful for finding a missing handset, page 17.

Also used during the registration process, page 40.

### Power/In use light

Green light flashes when the phone rings, during a call and during handset registration.

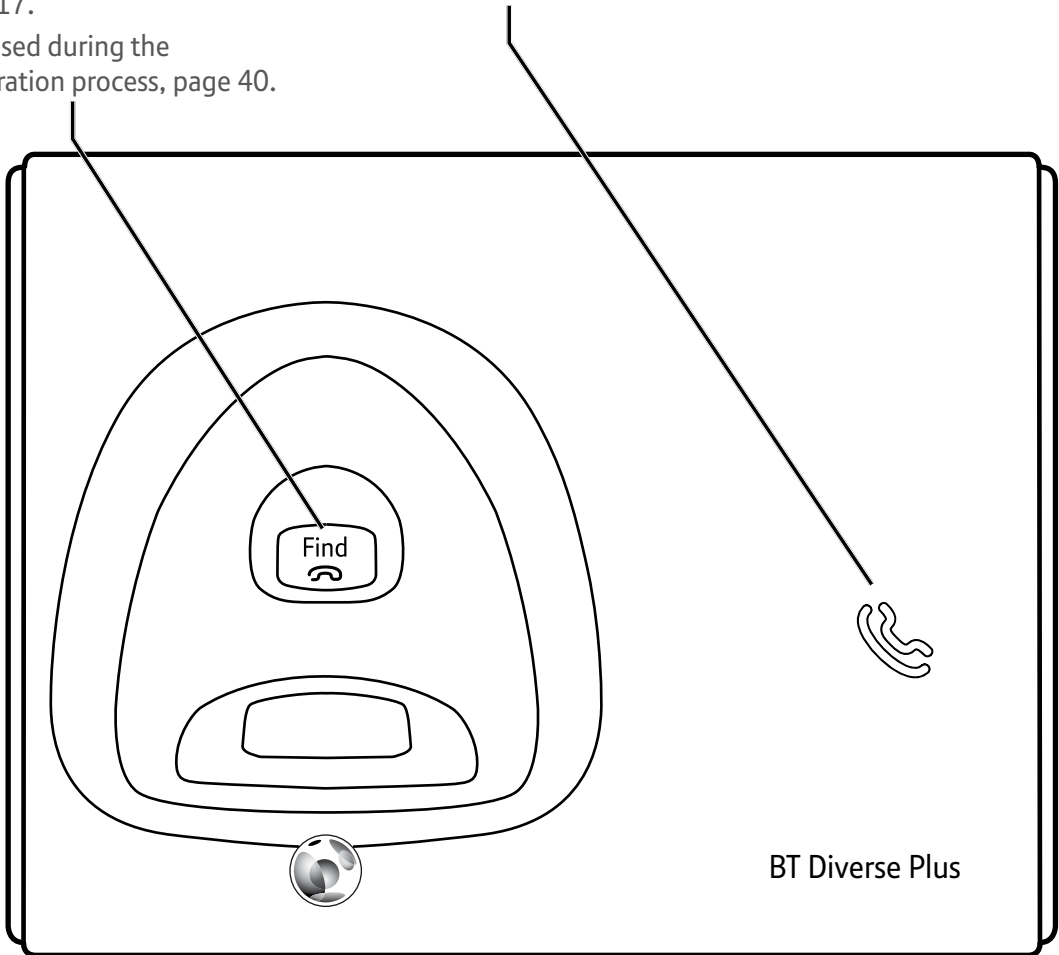









## Navigating the menus

Your BT Diverse 7410 Plus has an easy to use menu system.

Each menu has a list of options, which you can see on the menu map on the following page.

When the handset is switched on and in standby:

1. Press the right soft key  (Menu) to open the main menu.
2. Then use the  or  buttons to scroll through the available menu options.
3. Press the right soft key  (OK) to select a menu option or the left soft key  (Back) to return to the previous screen.
4. Use the  or  buttons to scroll through the sub menu options, then press the right soft key  (OK) to select or the left soft key  (Back) to return to the previous screen.

To exit a menu and return to standby, press .

### Left and Right soft keys

Press to select the option displayed on the screen.

#### Left soft key    Right soft key

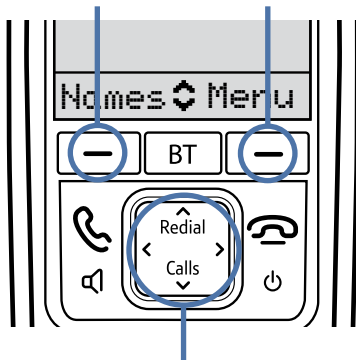

#### Navigation buttons

  Up and Down buttons

  Left and Right buttons

If no buttons are pressed for 30 seconds, the handset returns to standby automatically.

## Menu map

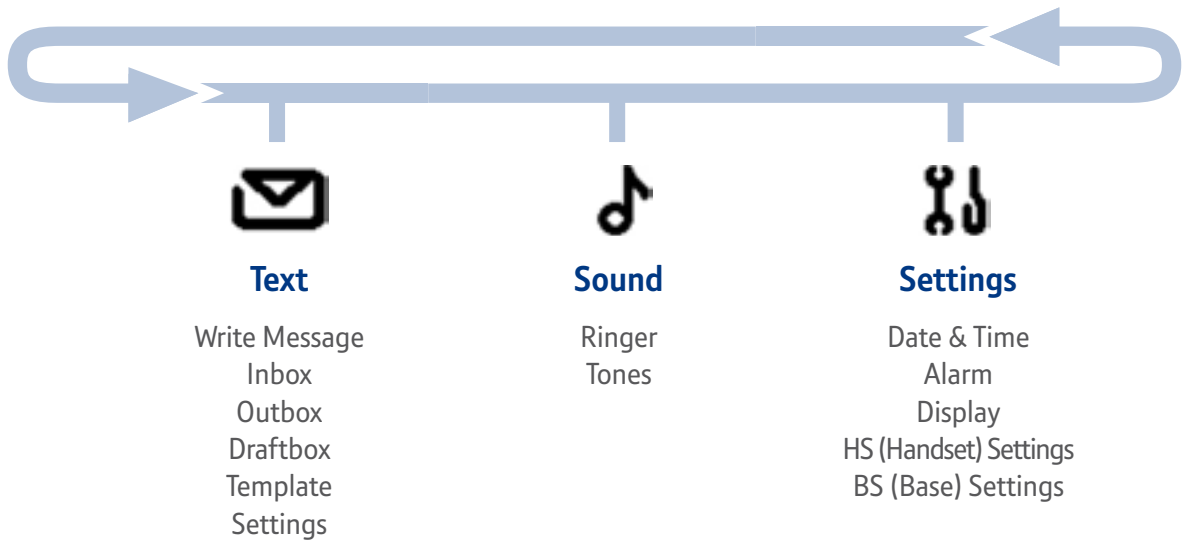

The following menus can be accessed by pressing the relevant button:

BT	Calls	Calls	Redial	Names or List Empty	List Empty
<b>BT menu</b>	<b>Calls list empty</b>	<b>Calls list displayed, press Options</b>	<b>Redial list displayed, press Options</b>	<b>Press Options</b>	<b>Phonebook is empty</b>
Helpdesk	Settings	Details	Details	Call Number	New Entry
BT 118500		Delete Entry	Delete Entry	Edit Entry	Capacity
Divert on		Delete All	Delete All	View Entry	
Divert off		Call Number	Call Number	Copy Entry <sup>2</sup>	
Check divert		Store Number <sup>1</sup>	Store Number <sup>1</sup>	Copy All <sup>2</sup>	
Call wait on		Settings		Delete Entry	
Call wait off				Delete All	
Chk call wait				Capacity	
Empty				Edit Call Group	
Empty				Speed Dial	

1 Only available if entry not already stored in the phonebook.

2 Only available if more than one handset is registered to the base.

# Using the phone

## Switch handset on or off

To switch off

1. Press and hold  for about 5 seconds.
2. Switch off handset? is displayed, press Yes to confirm.

To switch on



1. Press and hold  until the screen appears.

## Making and receiving calls

### Make an external call

1. Press .
2. When you hear the dial tone, dial the number.

### Preparatory dialling

1. Dial the number first. If you make a mistake press the left soft key  Clear to delete the last digit.
2. Press  to dial.

### End a call

1. Press .

### Receive a call

When you receive a call, the phone rings. The display shows the caller's number and if it matches an entry in the phonebook it shows the name also. If you do not have a Caller Display service, the screen shows External call.

1. Press .

### Earpiece / handsfree volume

During a call you can adjust the volume of the earpiece or loudspeaker. There are 5 levels.

1. Press  or  to increase or decrease the volume.

When you make a call, the  light on the base flashes.

### Call timer

Your handset will automatically time the duration of all external calls. The handset display shows the call duration both during and for a few seconds after your call.

### Out of range warning

When the handset goes out of range of the base, the  flashes. If you are on a call, the line will hang up. Move back within range. The handset will automatically re-connect to the base.



### Auto answer

As long as you have auto answer set to ON you can answer a call by lifting the handset off the base. If you have switched auto answer off, you will need to press  as well. Auto answer ON is the default setting. See page 25.

For more information on Caller Display, see page 30.



## Call Waiting

Providing you have subscribed to your network's Call Waiting service and it is switched on, your BT Diverse 7410 Plus will alert you to a second incoming call while you are already engaged on an external call.

1. You will hear the call waiting tone, then the display will show **Call Waiting** and the telephone number of the caller, or the stored name and number if it matches an entry in your phonebook.
2. Press  to answer the new call and your first caller is put on hold.
3. Press  to toggle between the two callers.
4. Press  to hang up the current call.

## Secrecy





During a call, you can talk to someone nearby without your caller hearing.

1. Press left soft key  (**Secrecy**). The display shows **Secrecy On** and your caller cannot hear you.
2. Press left soft key again  (**Off**) to return to your caller.

## Handsfree

Handsfree lets you talk to your caller without holding the handset. It also enables other people in the room to listen to your conversation over the loudspeaker.

### Make a handsfree call

1. Dial the number then press  twice.  is displayed. You hear your call over the handset loudspeaker. Press  to switch the call between the earpiece and the loudspeaker.
2. Press  to end the call.

To switch your Call Waiting service on or off, see page 33.



During a handsfree call, press  or  to change the volume.

## Answer a call handsfree



When the phone rings:

1. Press and hold  for at least 2 seconds. The call is answered in handset loudspeaker mode.

## Switch to handsfree during a call

1. During a call: press  to put the call on the loudspeaker. To switch handsfree off and return the call to the earpiece, press  again.

## Headset

A suitable headset is available to purchase from the BT Helpline 0800 218 2182\*, just press the  button followed by the  button to call them. The headset port should also be compatible with any other Headset/Microphone combination terminated with a 2.5mm plug with three metal contact bands (poles).

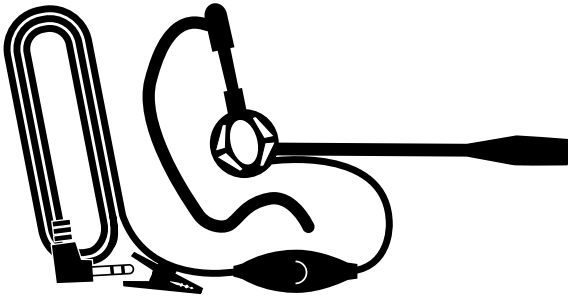



The headset socket is located on the side of the handset, peel back the rubber bung and plug the headset into the socket. You can then make and receive calls as normal.





## Redial

Up to the last 10 telephone numbers called are saved in the redial list. You can then select any of the numbers to redial, delete or copy to the directory.







### Redial the last number called

1. Press  the last number you called is displayed.
2. Press  to dial.





## Redial a number from the redial list

1. Press , the last number you called is displayed.
2. Press  or  to scroll to the number you want.
3. Press  to dial.



## Save a number from the redial list to the phonebook

1. Press  then scroll  or  to the number you want.
2. Press **Options** and scroll  to **Store Number**.
3. Press **OK**. Use the keypad to enter a name.
4. Scroll  to **Number**. The number is displayed. Press **OK**.
5. **Group** is displayed. If required, scroll  or  to select a group. Press **OK**. Display shows **Saved**.
6. Press **Back** to return to the standby screen.

## Delete a redial number

1. Press . The last number dialled is displayed.
2. Scroll  or  to the number you want.
3. Press **Options** and scroll  to **Delete Entry** and press **OK**. **Delete?** is displayed. Press **Yes** to confirm or **No** to cancel.
4. Press **Back** to return to the standby screen.

## Delete all redial numbers

1. Press . The last number dialled is displayed.
2. Press **Options** and scroll  to **Delete All** and press **OK**.
3. **Delete All?** is displayed. Press **Yes** to confirm or **No** to cancel.
4. Display shows **List Empty** and returns to the standby screen.

To view the details of the number, press **Options**. **Details** is displayed, press **OK**.

Press **Clear** to delete any unwanted digits and then enter new ones using the keypad.

If the phonebook is full, the display shows **Memory Full** and the number will not be saved. You will need to delete a number in the phonebook first, see page 20.



Call Groups available: **General**, **Family**, **Business**, **Friends**, **Utilities**, **VIP**, **Others** and **No Group**.





## Keypad lock

You can lock the keypad so that it cannot be used accidentally while carrying it around.

### To lock the keypad:



1. Press and hold . The handset beeps and Keypad Locked is displayed for 2 seconds before returning to the standby screen. The screen will show the  icon.

### To unlock the keypad:

1. Press and hold . The handset beeps and Keypad Unlocked is displayed for 2 seconds before returning to the standby screen. The  will disappear.

## Find handset (Paging)

You can ring a handset to help locate it.

1. Press and release  on the base. All handsets registered to the base will ring for up to 60 seconds.
2. Press  on the base again to stop the ringing or press a button on any handset.

### WARNING

If the keypad is locked you will still be able to dial the emergency numbers 999 and 112.

When the keypad is locked you can still answer incoming calls and operate the handset as normal. When the call is ended, the keypad lock comes on again.

Paging cannot be answered by a handset as a normal call.

The handset will ring even if the handset ringer has been turned off.

## Phonebook

You can store up to 200 names and numbers in the phonebook. Names can be up to 15 characters long and numbers up to 24 digits.

### Store a name and number in the phonebook

- From standby, press the left soft key **Names**. The phonebook menu is displayed.
- New Entry** is highlighted. Press **OK**.  
Or, if entries are already stored you will need to press **Redial** to highlight **New Entry** and then press **OK**.
- Enter the name (See the notes opposite for help). Press **OK**.
- Number** is displayed. Enter the number. Press **OK**.
- GROUP** is displayed and the group ringtone melody is played (you cannot change the ringtone at this stage, to do so later, see page 21). If you wish to add the entry to a call group, scroll **Redial** or **Calls** to select a group and press **OK**. Display shows **Saved** (if you don't want to use this feature, simply select **No Group**).
- Press **Back** to return to the standby screen.

### View an entry in the phonebook

- Press **Names**. The first entry is displayed.
- Scroll **Redial** or **Calls** to the entry you want.
- Press **Options** and scroll **Calls** to **View Entry**.
- Press **OK**. Scroll **Redial** or **Calls** to view the name, number and group.
- Press **Back** to return to the previous level.

### View phonebook capacity

- From standby, press **Names**. The phonebook is displayed.
- If there are no phonebook entries present, scroll **Calls** to **Capacity** and press **OK**. If there are phonebook entries, scroll **Calls** to any entry and press **Options**. Scroll **Calls** to **Capacity** and press **OK**.
- The number of entries used/available is displayed, e.g. **20/100**.
- Press **Back** to return to the previous menu level.

### Entering names

Use the keypad letters to enter names, e.g. to store Tom:

Press **8** once to enter T.  
Press **6** three times to enter o.  
Press **6** once to enter m.

### Writing tips

Press **Clear** to delete the last character or digit.

Press **Redial** or **Calls** to move backwards or forwards through character/digits.

Press **\*** to switch between upper, lower or sentence case.

Press **1** to insert a space.

Use **1** and/or **0** for other punctuation characters.

### Call groups

When you store names and numbers you can also store the entry under a call group name, e.g. **Family** or **Friends**. You can also allocate a different ringtone to each call group, see page 21. If you don't want to use this feature simply store each entry under **No Group** and your normal ringtone will sound when someone calls.

### The call group options are:

No Group	Friends
General	Utilities
Family	VIP
Business	Others



To exit phonebook entry mode, press **Back** to return to the standby screen.

### To enter a pause in a phonebook number





When storing a number press and hold **0** and a **P** will be displayed.

For more information on pauses, see page 53.





## Dial an entry in the phonebook

1. In standby, press **Names**. The first entry is displayed.
2. Scroll  or  to the entry you want or search alphabetically.
3. Press  to dial.

## Edit a name and number in the phonebook

1. Press **Names**.
2. Scroll  or  to the entry you want.
3. Press **Options** and scroll  to **Edit Entry** and press **OK**.
4. **Name** is displayed. Use the keypad to enter a new name. Press **OK**.
5. **Number** is displayed. Use the keypad to enter a new number. Press **OK**.
6. **Group** is displayed. Press  or  to select a different group. Press **OK**.
7. Press **OK**. Display shows **Saved**.

## Copy an entry from the phonebook to another handset

1. Press **Names**. Then scroll  or  to the entry you want to copy.
2. Press **Options** and scroll  to **Copy Entry** and press **OK**.
3. Press  or  to select the handset you want to copy to and press **OK**.

At the receiving handset:

4. Display shows **Accept Entries?** Press **Yes** to confirm or **No** to cancel.
5. When successful the display shows  **Finished**.
6. Press **Back** to return to the previous menu level.

### To search alphabetically

Press the relevant keypad button, e.g. for the entries beginning with **T** press  once then scroll  or  through the entries.

When editing a name or number, press **Clear** to delete characters and digits.

Use the  or  to move the cursor left or right.

To exit edit mode, press  to return to the standby screen.

Copy and copy all menu options are only available if more than one handset is registered to the base.



If you copy an entry that already exists in the receiving handset it will create a duplicate entry.

If copying is not successful, the display will show **Copying failed** on the transmitting handset.

If the phonebook is full the display will show **Memory full** on the receiving handset.

If the copying process is interrupted (e.g. an incoming call or flat battery), the copy process will stop.



## Copy all phonebook entries to another handset

1. Press **Names**. The first entry is displayed.
2. Press **Options** and scroll  to **Copy All** and press **OK**.
3. Press  or  to select the handset you want to copy all entries to and press **OK**.



At the receiving handset:

4. Display shows **Accept Entries**. Press **Yes** to confirm or **No** to cancel.
5. When successful the display shows  **Finished**.
6. Press **Back** to return to the previous menu level.

## Delete an entry in the phonebook

1. Press **Names**.
2. Scroll  or  to the entry you want.
3. Press **Options** and scroll  to **Delete Entry** and press **OK**. Display shows **Delete?** Press **Yes** to confirm or **No** to cancel.
4. Press **Back** to return to the standby screen.

## Delete entire phonebook

1. Press **Names**.
2. Scroll  to any phonebook entry and press **Options**. Scroll  or  to **Delete All** and press **OK**.
3. Display shows **Delete All Entries?** Press **Yes** to confirm or **No** to cancel.
4. Press **Back** to return to the standby screen.





If the phonebook becomes full during copying the display shows **Memory Full**.

If copying is not successful the display shows **Copying failed**.

If you copy an entry that already exists in the receiving handset it will create a duplicate entry.

If the copying process is interrupted (e.g. an incoming call or flat battery), phonebook entries after this interruption will not be copied.









## Edit call group name

1. Press **Names**.
2. Scroll  to any phonebook entry and press **Options**.  
Scroll  or  to **Edit Call Group** and press **OK**.
3. Scroll  or  to the call group you want and press **OK**.
4. Display highlights **Rename Group**. Press **OK**.
5. Press **Clear** to delete the current name and enter a new name.
6. Press **OK** to save.
7. Press **Back** to return to the previous menu level.

Call group names cannot exceed 10 characters.

## Change call group ringtone

You can set different ringtones for each call group so you will know when someone from a certain call group is phoning you.

1. Press **Names**.
2. Scroll  to any phonebook entry and press **Options**.  
Scroll  or  to **Edit Call Group** and press **OK**.
3. Scroll  or  to the call group you want and press **OK**.
4. Scroll  to **Set Ringtone**. Press **OK**.
5. Press  or  to choose the ringtone. A sample of each one is played. Press **OK** to save.
6. Press **Back** to return to the previous menu level.

## Speed dial

You can allocate a name and number from the phonebook to each of the Speed dial buttons **2<sup>AB</sup><sub>C</sub>** to **9<sup>WX</sup><sub>YZ</sub>**. Then you can simply press and hold the Speed Dial button to automatically dial the number stored under it.







### Copy a phonebook entry to a Speed Dial button

1. Press **Names**.
2. Press **Options** and scroll **Redial** or **Calls** to **Speed Dial** and press **OK**.
3. Scroll **Redial** or **Calls** to the Speed Dial button you want (button **2<sup>AB</sup><sub>C</sub>** to **9<sup>WX</sup><sub>YZ</sub>**) and press **OK**.
4. If a name and number is already allocated to the Speed Dial button you have chosen they will be displayed. To re-use this Speed Dial button see, “Edit a Speed Dial entry”, on page 23.
5. If the Speed Dial is empty **No number** is displayed and then the screen shows all your Phonebook entries. Scroll **Redial** or **Calls** to the entry you want to select and press **OK** to save.
6. Press **Back** to return to the previous menu level.



### Delete a Speed Dial entry

1. Press **Names**.
2. Press **Options** and scroll **Redial** or **Calls** to **Speed Dial** and press **OK**.
3. Scroll **Redial** or **Calls** to select the Speed Dial button number you want to delete and press **OK**.
4. The name and number is displayed, press **Options** and scroll **Calls** to **Delete**.
5. Press **OK** to confirm, **Deleted** is displayed.
6. Press **Back** to return to the previous menu level.

## Edit a Speed Dial entry

1. Press **Names**.
2. Press **Options** and scroll  or  to **Speed Dial** and press **OK**.
3. Scroll  or  to the Speed Dial button you want to edit and press **OK**.
4. The name and number is displayed, press **Options** and **Edit** is displayed.
5. Press **OK** to confirm, and then scroll  or  to the entry in the phonebook you want and press **OK** to save.
6. This new name and number from the phonebook will replace the old name and number for this Speed Dial button.
7. Press **Back** to return to the previous menu level.





## Dial a Speed Dial entry

1. Press and hold the Speed Dial button ( to ) that holds the number you wish to dial.
2. The display shows the  icon and the number being dialled.





# Sounds

The following sounds settings are for the handset, see page 26 to change the base ringer volume and melody.





## Handset ringer melody (for external or internal calls)

1. Press Menu, scroll  to Sound and press OK.
2. Ringer is highlighted. Press OK.
3. External Calls is highlighted, either press OK to select or scroll  to Internal Calls and then press OK.
4. Press  or  to select the melody you want and press OK.





## Handset ringer volume (including ringer off)

1. Press Menu, scroll  to Sound and press OK.
2. Ringer is highlighted, press OK.
3. Scroll  to Volume and press OK.
4. Scroll  or  to select the volume level 1-5 or off and press OK.

## Set to quiet mode

1. Press Menu, scroll  to Sound and press OK.
2. Ringer is highlighted, press OK.
3. Scroll  to Quiet Mode and press OK.
4. Press  or  to select Beep or Off and press OK.

## Handset beeps

1. Press Menu, scroll  to Sound and press OK.
2. Scroll  to Tones. Press OK.
3. Key Tone is highlighted, press OK or scroll  to either Confirmation Tone, Low Battery Tone or Out of Range and then press OK.
4. Press  or  to select On or Off, then press OK to confirm.
5. Press Back to return to the previous menu level.

You can set different ringtones for external calls and internal calls.

Choose from 10 polyphonic and 5 standard handset ringtones. Melody 1-5 are standard and Melody 6 to 15 are polyphonic.

### Important

Changing the handset ringer melody will only change the ringer melody you hear when callers stored under No Group in your phonebook or callers whose numbers are not stored in your phonebook call you. To change the ringer melody for callers stored under different call groups, see page 21 or for more information on call groups, see the notes on page 18.

The handset has 5 ringer volume settings plus Off.

The  icon will be displayed in the idle screen when the ringer is set to Off.

As a quick way to switch the handset ringer off, press and hold .

If you switch the handset ringer off you can still hear a tone when you receive an incoming call by changing the Quiet Mode setting to Beep.

Your handset can give a key beep to each button press. It can also give a tone to confirm a successful action such as storing a new phonebook entry. You can switch these tones on or off individually.







# Settings



## Handset settings

### Select base



You can use this feature if you've registered your handset to two different bases.

1. Press Menu, scroll  to Settings and press OK.
2. Scroll  HS Settings and press OK.
3. Select Base is displayed, press OK.
4. Press  or  to select the base (Base 1-4) and press OK.

### Display contrast / Handset name





1. Press Menu, scroll  to Settings and press OK.
2. Scroll  to Display and press OK.
3. Handset Name is displayed, press OK. Either: press Clear to delete the current name. Enter a new name and then press OK to save.

Or

Scroll  to Contrast, press OK. Scroll  or  to select the contrast setting and press OK.

4. Press Back to return to the previous menu level.

### Auto answer





1. Press Menu, scroll  to Settings and press OK.
2. Scroll  to HS Settings and press OK.
3. Scroll  to Auto Answer and press OK.
4. Press  or  to select On or Off and press OK to save.
5. Press Back to return to the previous menu level.

Adjust the display contrast to suit different lighting conditions. There are 8 levels.



Set a name for your handset, e.g. Donna or Office.

As long as you have auto answer set to ON you can answer a call by lifting the handset off the base. If you have switched auto answer off, you will need to press as well. Auto answer ON is the default setting.

## De-register a handset







1. Press Menu, scroll  to Settings and press OK.
2. Scroll  to HS Settings and press OK.
3. Scroll  to De-Register and press OK.
4. Enter your 4-digit system PIN code (default 0000) and press OK.
5. Press  or  to select the handset number you want to de-register and press OK.
6. The display will show De-register Handset X? Select either Yes or No and press OK.

## Handset reset

1. Press Menu, scroll  to Settings and press OK.
2. Scroll  to HS Settings and press OK.
3. Scroll  to Reset Handset and press OK.
4. Enter the 4 digit system PIN code (default 0000) and press OK.
5. Display will show Reset Handset to Default? Press Yes to confirm or No to cancel.

## Base settings

### Base ringer melody and volume

1. Press Menu, scroll  to Settings and press OK.
2. Scroll  to BS Settings. Press OK.
3. Ringer is highlighted. Press OK.
4. Melody is highlighted, press OK. Press  or  to select the melody 1-15 and press OK.
5. Scroll  to Volume and press  or  to select the volume level 1-5 or off and press OK.
6. Press Back to return to the previous menu.

You cannot de-register the handset you are using.



For information on changing the system PIN, see page 27.

Restore your handset to its original factory settings. This will not affect:





- The phonebook
- Text messages stored in the Inbox or Draftbox
- The Calls list

Choose from 15 base ringtones. There are 5 volume levels and Off.

## Handset ringing priority





1. Press Menu, scroll  to Settings and press OK.
2. Scroll  to BS Settings. Press OK.
3. Scroll  to Ring Priority. Press OK.
4. All Handsets is highlighted. Press OK for all handsets to ring together.

Or





Scroll  to Select Handset. Press OK then press  or  to select the handset you want to ring first. Press OK.  
The ring delay option is highlighted. Press  or  to set the number of rings before the other handsets ring. Press OK.

5. Press Back to return to the previous menu.



## Recall mode

1. Press Menu, scroll  to Settings and press OK.
2. Scroll  to BS Settings. Press OK.
3. Scroll  to Recall Mode. Press OK.
4. Press  or  to select Timed Break or Earth and press OK.

## Repeater mode

1. Press Menu, scroll  to Settings and press OK.
2. Scroll  to BS Settings. Press OK.
3. Scroll  to Repeater Mode. Press OK.
4. Off is highlighted. Scroll  to On and press OK.
5. Press  to return to the idle screen.

## System PIN

1. Press Menu, scroll  to Settings and press OK.
2. Scroll  to BS Settings. Press OK.
3. Scroll  to System PIN. Press OK.
4. Enter the old PIN (default setting 0000) and press OK.
5. Enter the new PIN and press OK. Re-enter the new PIN and press OK. The display will show Saved.

When you have more than one handset registered to your base, you can set one handset to ring before the others. This allows one handset user to answer all incoming first, like a receptionist.

Choose All Handsets if you want all handset to ring at the same time or Select Handset to nominate a handset to ring before the others.

Ring delay options; 2, 4, 6 or 8 rings.

Earth and Timed Break are settings for switchboard use. If in doubt please contact your switchboard service provider.

You can use a Repeater to boost the range and reception of your base. A Repeater must be registered with the base and the Repeater function must be set to ON.





The System PIN is used when changing certain settings and registration / de-registration. The default setting is 0000. You can change this to your own preferred 4-digit number.

If you make a mistake, press Clear to delete digits.

## PBX access code



If you are connected to a switchboard you may need to enter an access code (e.g. 9) before each number is dialled. Your BT Diverse 7410 Plus can store an access code which is automatically dialled before each number.

### Set the PBX access code.

1. Press Menu, scroll  to Settings and press OK.
2. Scroll  to BS Settings. Press OK.
3. Scroll  to PBX Access Code. Press OK.
4. The contents will be blank, enter the number you want (single digit only) and press OK.
5. Press  to return to the idle screen.

### Reset base







This resets your BT Diverse 7410 Plus to its original settings.

1. Press Menu, scroll  to Settings and press OK.
2. Scroll  to BS settings. Press OK.
3. Scroll  to Reset Base. Press OK.
4. System PIN: is displayed. Enter the system PIN (default setting = 0000) and press OK.
5. Display shows Reset Base to Default? Press Yes to confirm or No to cancel.
6. Press Back to return to the previous menu level.





## Date/Time/Alarm

### Set date and time













Providing you have subscribed to your network's Caller Display service, the date and time is set automatically when you receive your first call.

1. Press Menu, scroll  to Settings and press OK.
2. Date & Time is highlighted. Press OK.
3. Time Format is highlighted, press OK. Press  or  to choose 24 Hour or 12 Hour and press OK.
4. Scroll  to Date Format and press OK. Press  or  to select DD/MM/YYYY or MM/DD/YYYY and press OK.

If an extension number of six digits or less, or a local number without the dialling code is entered in the phonebook then an access code and Pause will prefix the number when dialled out.

5. Scroll  to **Enter Time** and press OK. Enter the time using the keypad as either the 24 hour or 12 hour format (previously selected), e.g. 17:30 or 05:30. If 12 hour format was chosen, press  or  to select AM or PM. Press OK.
6. Scroll  to **Enter Date** and press OK. Enter the date e.g. 09 04 2011 (displayed as 09/04/2011) for 9 April 2011 and press OK.
7. Press **Back** to return to the previous menu level.

## Set alarm call

1. Press **Menu**, scroll  to **Settings** and press OK.
2. Scroll  to **Alarm** and press OK.
3. Scroll  to **Time** and press OK.
4. Enter the alarm time, using the 24 or 12 hour format, depending on which format you've previously selected and press OK.
5. Scroll  to **Alarm On/Off** and press OK. Press  or  to select **Once** or **Daily** and press OK.
6. Scroll  to **Activation** and press OK. Press  to **On** and press OK.
7. Scroll  to **Melody** and press OK. Press  or  to select the ringtone you want for the alarm (Melody 1-15). Press OK to save.
8. Press  to return to the standby screen. The  icon is displayed if the alarm was set.

You must set the alarm activation to **ON** for the alarm to ring.

You can select melody 1-15 for the alarm ringtone.

## Stop alarm ring

When the alarm rings, the display shows «Alarm» and the  icon flashes. The alarm rings for 30 seconds.

1. Press **STOP** to stop the alarm.

# Calls list

## Caller Display

If you have subscribed to a Caller Display Service, you will be able to see your caller's number on your handset display (provided it is not withheld) prior to answering the call.



If your caller's name is stored in the phonebook and a number match is found, you will see the caller's name and number on the display.

## Calls list





The calls list holds details of up to 30 received calls. The date and time of the call is stored if available.

When the list is full, and a new call is received, the oldest entry will be deleted automatically.

The Calls list can hold numbers up to 24 digits and names up to 16 characters.

Unread, missed calls are displayed with a  icon next to the caller's name or number. Read, missed calls have a  icon next to the caller's number.

## View call details

1. Press , the most recent entry is at the top of the list.
2. Press  or  to scroll through the list.
3. Press **Options**. **Details** is highlighted. Press **OK**.
4. The display shows the phone number, date and time of the call.
5. Press  or  to display details about the next call.
6. Press **Back** to return to the previous menu level.

## IMPORTANT

To use Caller Display you must first subscribe to the service from your network provider. A quarterly fee may be payable. For more information on

BT Calling Features call BT free on 0800 800 150.

To ensure the caller's name is displayed, make sure you have stored the full telephone number, including the dialling code in the directory.

The  icon will appear in the display when a missed call is received.

To remove the icon you need to view the missed calls, see 'View call details' below.

If the number is unavailable, **Unavailable** is displayed.

If the number has been withheld by the caller, **Withheld** is displayed.

If the call is from the operator, **Operator** is displayed.

If the call is from a payphone, **Payphone** is displayed.





If the call is from a callback request, **Callback** is displayed.

If you do not have a Caller Display service, an external call is displayed as **External Call**.





When there are no calls in the calls list, the display shows **Empty** then will offer the **Settings** option.

When a Calls list is open, press  to scroll from the newest call to the oldest, or press  to scroll from the oldest call to the newest.







## Dial from the Calls list

1. Press , the most recent entry is at the top of the list.
2. Press  or  to scroll through the list.
3. Press  to call the number.







Or

1. Press .
2. Press  or  to scroll through the list to the entry you want.
3. Press Options. Scroll  to Call Number and press OK.

## Copy a Calls list number to the phonebook

1. Press .
2. Press  or  to scroll through the list to the entry you want.
3. Press Options. Scroll  to Store Number and press OK.
4. Enter the name and press OK.
5. Number is displayed. Edit the number if required and press OK.
6. GROUP is displayed. Press  or  to set the call group you want.
7. Press OK to save.
8. Press Back to return to the previous menu level.

## Calls list settings: Calls list type / New call alert

1. Press .
2. Press Options. Scroll  to Settings and press OK.
3. Calls List Type is displayed, press OK. Press  or  to select All Calls or New Calls and press OK.
4. Scroll  to New Call Alert and press OK. Press  or  to select On or Off and press OK.
5. Press Back to return to the previous menu level.

If you need to edit the number or name, press Clear to delete any unwanted characters, then enter new ones using the keypad.

### New call alert

The new call alert will cause the handset to beep when a missed call is received in the calls list and has not been viewed yet. The default setting is Off.





If you turn the new call alert Off and the beeping continues, you may need to clear all calls in the calls list to stop it.

### Calls List Type



All Calls will list answered and missed calls in the Calls list.

New Calls will only list unanswered calls.

## Delete an entry in the Calls list

1. Press .
2. Press  or  to scroll through the list to the entry you want.
3. Press Options. Scroll  to Delete and press OK. Delete? is displayed, press Yes to confirm or No to cancel.
4. Press Back to return to the previous menu level.

## Delete entire Calls list

1. Press .
2. Press Options. Scroll  to Delete All and press OK.
3. Delete All? is displayed, press Yes to confirm or No to cancel.
4. Press Back to return to the previous menu level.

## Voicemail

1. If you have subscribed to the BT Answer 1571 service you can press and hold  to listen to your messages.
2. The display shows Listen to Info. Follow the spoken instructions if appropriate.





# BT Network Services

By selecting the BT Services menu you can access a range of useful pre-stored numbers and further BT Calling Features.

## Pre-stored BT Services numbers:

- Helpdesk
- BT 118500 (directory enquiries)
- Divert on
- Divert off
- Check divert
- Call wait on
- Call wait off
- Check call wait



## BT Diverse 7410 Plus Helpdesk

1. Press  (a short press only).
2. Helpdesk is highlighted. Press  to call.



## BT 118500 (Directory Enquiries)

1. Press  (a short press only).
2. Scroll  to BT 118500 and press  to call.

## Call Divert on/off/check

1. Press  (a short press only).
2. Scroll  to Divert on, Divert off or Check divert. Press OK.
3. Press  to call. Follow the spoken instructions, or listen for confirmation/status of your instructions.

## Call Waiting on/off/check

1. Press  (a short press only).
2. Scroll  to Call wait on, Call wait off or Chk call wait. Press OK.
3. Press  to call. Follow the spoken instructions, or listen for confirmation/status of your instructions.

### IMPORTANT

To use BT Services and BT Calling Features you must first subscribe (if required) to the relevant service from your network provider. A quarterly fee may be payable. For more details on BT's Calling Features, call BT free on 0800 800 150.

If you are not connected to the BT network, some of these services may not be available. Please contact your network provider. Call Diversion services may allow other divert options. Check with your network provider for details.

For further information, see the BT Calling Features user guide supplied when you subscribe to the services of your choice.

A long press and hold of the  button will emit an error beep (if the handset key tone is set to on) and will not open the BT menu.

Call Divert will divert all incoming calls to another number of your choice.

Call Waiting lets you know if another person is trying to contact you while you are on a call. If a second caller rings you will hear a beep in the handset. Providing you have also subscribed to Caller Display, the screen will show the caller's details.

## Show/Edit/Delete BT Services numbers

1. Press **BT** (a short press only).
2. Scroll **Redial** or **Calls** to select the entry you want and press **Options**.
3. Scroll **Redial** or **Calls** to **Show Details** and press **OK**.  
The number allocated to that entry is displayed.  
Press **Back** to return to the previous menu level.
4. From, step 2 above you can also scroll **Calls** to **Edit Entry**, **Delete Entry** or **Delete All**. Press **OK** then follow the procedure for editing or deleting phonebook entries as shown on page 19 and 20 of this guide.

To reset the BT Services numbers back to the pre-stored numbers you can reset the handset to its original factory default settings, see page 28.

# Text messaging (SMS)

Welcome to the BT text messaging service on your BT Diverse 7410 Plus. Your BT Diverse 7410 Plus can send and receive text messages from participating mobile networks and compatible landline telephones in the UK.

The fixed line text service is provided under BT's terms and conditions for telephone service. These can be found by visiting the BT.com website at: <http://www.bt.com/terms>

## Subscribe to the text messaging service

When you send your first text message from your BT Diverse 7410 Plus you will automatically be registered for the service.

On receipt of your first text through the service, the system will send you a welcome text message back.

You may also register by sending the word `Register` to 00000 upon which you will receive a confirmation message.

## Cost of the fixed line service

There is no subscription charge (other than the subscription to Caller Display). Visit the BT.com website ([www.bt.com](http://www.bt.com)) to find out how much it costs to send a text message (depends upon your call package).

## Sending messages

### Send a text message

1. Press `Menu`, `Text` is displayed. Press `OK`.
2. Write `Message` is highlighted. Press `OK`.
3. Use the keypad to enter your message.

Press `Options` and scroll `Redial` or `Calls` to:

`Send` Press `OK`.

Enter the phone number and press `Send`.

### IMPORTANT

You must subscribe to your Network Provider's Caller Display service so that you can use text messaging and you must not withhold your telephone number. A quarterly fee may be payable, please contact your network provider for more details.

You may also send messages to landline phones that are NOT text compatible. Messages to non-compatible lines will be connected to voice text and delivered in spoken words to the telephone as a call. Please note that the conversion can translate common abbreviations and smileys etc, but to ensure maximum clarity of message delivery, abbreviations etc should be used sparingly.

### Writing tips

Use the keypad to enter letters and numbers, eg to write `today (2day)`:

Press `2` <sup>AB</sup><sub>C</sub> four times to enter `2`.

Press `3` <sup>DEF</sup> once to enter `d`.

Press `2` <sup>AB</sup><sub>C</sub> once to enter `a`.

Press `9` <sup>WXYZ</sup> three times to enter `w`.



Press `1` <sub>↵</sub> to enter a space and use `1` <sub>↵</sub> and/or `0` for other characters, punctuation marks and symbols.

Press `Clear` to delete incorrect characters.



### Upper & lower case

Press `*3` to change between upper (ABC), lower (abc) and sentence (Abc) case letters.

Maximum number of characters in a text message is 160. The display shows a character countdown from 160 down to 0.

Or press **Options** to select a number from the Phonebook, Redial list or Calls list. Scroll  or  to the option you want and press **OK**. Scroll to the entry or number you want and press **OK**. Press **OK** again to send.

**Store as Draft** Press **OK** to save the message in the Draftbox for sending later.





**Template** To insert a template, press **OK**. The template options are displayed. Press  or  to highlight the template you want then press **OK** to insert the template into your text.

4. When sending a message, the display shows **Sending Text** then **Sent**.

5. Press  to cancel at any time and return to standby.

If a text message you tried to send was not successful, it is stored in the Outbox.

## View messages in the Outbox

1. Press **Menu**, **Text** is displayed, press **OK**.
2. Scroll  to **Outbox** and press **OK**.
3. Scroll  or  to the message you want and press **Read**.
4. Press **Options** and scroll  or  to:

**Send** Press **Send** to re-send the message to the original recipient.

**Details** Press **OK** to display the telephone number and date and time the text was received.

**Delete** Press **OK**. Display shows **Delete?**  
Press **Yes** to confirm or **No** to cancel.

**Delete All** Press **OK**. Display shows **Delete All?**  
Press **Yes** to confirm or **No** to cancel.

**Store as draft** Press **OK**. The display shows **Saved**.

At any time, press **Back** to go back to the previous screen, or press  to cancel and return to standby.

If the text is not sent, the display shows **Aborted!**

It is stored in the Outbox and a  icon is shown next to the entry.

In order to send and receive text messages you must not withhold your number. On most networks if you normally withhold your number the 1470 prefix presents your number for you.

### Templates

There are five pre-set templates:

Please call

I'll be there at

What time will you be home?

I'll call you

Happy Birthday!

### Receiving a call while writing a text

If you are writing a text and you receive a call your text can be recovered from the Draftbox to continue editing.

## Using the Draftbox

Draft texts you store are kept in the Draftbox.

1. Press **Menu**, **Text** is displayed. Press **OK**.
2. Scroll **Calls** to **Draftbox**. Press **OK**.
3. Scroll **Redial** or **Calls** to the message you want and press **Options**.
4. Press **Redial** or **Calls** to select **Read**, **Delete** or **Delete All** and press **OK**.
5. If you select **Read**, you can edit the message, then press **Options** and scroll **Redial** or **Calls** to select **Save**, **Send**, **Delete** or **Delete All** and press **OK** to confirm.
6. Press **Power** to cancel at any stage and return to standby.

## Receiving messages

When you receive a new text message, the  icon is displayed and **New Text** is displayed on the idle screen.

### Read messages



1. Press **Menu**, **Text** is displayed. Press **OK**. Scroll **Calls** to **Inbox** and press **OK**.
2. Scroll **Redial** or **Calls** to the text you want to read and press **Read**.
3. Press **Redial** or **Calls** to scroll through the text.
4. Press **Options** and scroll **Redial** or **Calls** to:

**Reply** Press **OK**. **Reply with original text?** is displayed.  
Press **No** to use a blank message or **Yes** to keep original text in the reply.  
Enter your message and press **Send**.





**Details** Press **OK** to display the telephone number and date and time the text was received.

**Forward** Press **OK**. Add more text if required and proceed as shown on page 35 for creating a new message.

Unread messages are marked new with the  icon.

- Call Number Press OK. The telephone number is displayed  
Press  to dial the number.
- Store Number Press OK. The telephone number is displayed.  
Enter a name for the number following the instructions to store a name in the phonebook as shown on page 18.
- Delete Press OK. Display shows Delete?  
Press Yes to confirm or No to cancel.
- Delete All Press OK. Display shows Delete All?  
Press Yes to confirm or No to cancel.
- Store as draft Press OK. The display will show Saved.
5. Press  to cancel at any time and return to standby.

## Edit or delete templates

1. Press Menu, Text is displayed. Press OK.
  2. Scroll  to Template and press OK.
  3. Scroll  or  to the template you want to edit or delete.  
Press Options.
  4. Scroll  or  to select either Edit Template or Delete Template and press OK.
- Edit Entry Press Clear to delete characters.  
Enter your template text and press OK.
- Delete? Press Yes to confirm or No to cancel.
5. Press Back to return to the previous menu level.

## Service Centre numbers

To send and receive text messages you need the telephone number of your Network's text Centre. If you accidentally delete the Send or Receive Service Centre numbers you will need to re-enter them in order for your text Service to work.

You can enter up to 4 Service Centre numbers – two Send and two Receive.

The Send Service number is: 1470P1709400.

The Receive Service number is: 0800587529.

### There are five pre-set templates

Please call  
I'll be there at  
What time will you be home?  
I'll call you  
Happy Birthday!

You can change the templates to your preferred message, up to a maximum of 20 characters.

If you delete a template without replacing the text it is marked as Empty.

All templates are restored if you reset your BT Diverse 7410 Plus to its default settings, see page 28.





### Do you have two text phone bases connected to the same phone line?

If you have two text phone base stations plugged into one line, you are likely to experience problems receiving text messages. Normally, only one SMS enabled base unit (DECT or cordless) can be plugged into any line.

If you do want to use two base units and still receive written text you must delete receive service centre number from one of the base stations. To do this on your BT Diverse 7410 Plus, see page 39. This will allow you to send text via either base station but texts will only be received on the product with the active receive centre number.





If you want to keep more than one text enabled phone connected see the alternative method on page 46 for instructions.

## Add or change Service Centre numbers

1. Press **Menu**, **Text** is displayed. Press **OK**.
2. Scroll  or  to **Settings** and press **OK**.
3. **Text Centre** is highlighted press **OK**.
4. Scroll  or  to **Send Centre 1 or 2** or **Receive Centre 1 or 2** and press **OK**.
5. If necessary, press **Clear** to delete the current number. Enter the new service centre number and press **OK**.
6. Press **Back** to return to the previous menu level. Or press  to return to standby.

## Select Send Service Centre

Only service centres that have numbers stored will be displayed as Send Centres.





1. Press **Menu**, **Text** is displayed. Press **OK**.
2. Scroll  or  to **Settings** and press **OK**.
3. Scroll  to **Send Service** and press **OK**.
4. Press  or  to select the **Send Centre** menu and press **OK**.

## Message alert

When you receive a text message:

- the new message beep will sound at the handset.
  - the new text message icon is shown on the handset display.
  - the base indicator light flashes.
- These alerts can be switched **On** or **Off**.  
The default setting is **On**.

## Switch new text message alert on or off

1. Press **Menu**, **Text** is displayed. Press **OK**.
2. Scroll  or  to **Settings** and press **OK**.
3. Scroll  to **New Text Alert** and press **OK**.
4. Press  or  to select **On** or **Off** and press **OK**.
5. Press **Back** to return to the previous menu level.

If you have more than one 'Text Centre' stored on your BT Diverse 7410 Plus you will need to select which one you want to use for sending (see next section below).

# Using additional handsets

You can use up to five BT Diverse additional handsets with your BT Diverse 7410 Plus base to extend your phone system without needing to install extension sockets for each new phone.



Your BT Diverse 7410 Plus handset can also be registered to up to four other bases. You can then select the base you would prefer to use.

If you have purchased an additional handset you must register it to your BT Diverse 7410 Plus base before it can be used. The batteries must be fully charged for 24 hours before you register it.

You may be able to register other DECT handsets to your BT Diverse 7410 Plus. Compatibility of products may vary and the number of features available may be reduced in doing so.

## Easy registration of a new additional Diverse handset

To use easy registration a new handset must be used and the base must have the PIN code 0000. (If the base PIN has been changed then the longer registration procedure on the following page will need to be followed).

1. The display will show `Please Register` and once the handset has been fully charged for 24 hours, press `Reg` (left soft key).
2. The display will show `Press and Hold Base Find Key`. The  button is located on the Diverse base underneath where the handset sits. Press and hold the  button on the base for approximately 8 seconds until the base beeps, then release.
3. Immediately, press `OK` on the handset to confirm. The base will go into registration mode for 90 seconds and will beep when registration is successful. The handset will automatically be assigned the next available handset number and registration is now complete.

Registration of handsets can only take place while the base is not engaged on another call.

If registration is not successful first time, please repeat the process again in case the base registration period ran out of time.

If there are already 5 handsets registered to the base, the registration will fail. You must de-register another handset before you can register the new one.







If your BT Diverse 7410 Plus handset is registered to more than one base, you can select which base to use, see page 25.

If you have a handset registered to more than one base and then de-register it from one of them you will need to re-select which base to use. Until the base is selected the handset will display `Please Register`.



## Registration of an additional handset when base PIN changed (i.e. if PIN changed from default setting of 0000)

At the handset:

1. Press Menu, scroll  to Settings and press OK.
2. Scroll  to HS Settings and press OK.
3. Scroll  or  to Register and press OK.
4. Press  or  to select the base you want (1-4). You should only select a base that has a \* displayed beside it. Press OK.
5. Enter the 4-digit system PIN then press OK. The display shows Overwrite the registration on Base x? Press Yes.
6. Press and Hold Base Find Key is displayed, press OK on the handset to commence registration.



At the base:

1. Press and hold  for approximately 8 seconds until it beeps and then release. Press OK on the handset to confirm. The base will go into registration mode for 90 seconds and will then beep if registration is successful. The handset will automatically be assigned the next available handset number.

## Internal calls

### Call another handset

If you have more than one handset registered to the base, you can make internal calls between two handsets.

1. Press  and if you have one other handset it will ring. If you have other handsets, press  or  to select the handset (1-5) you want to call, then press OK.

## Transfer a call

You can transfer an external call to another handset registered to the base.

1. During your call, press **Intercom**. Your external caller is put on hold.
2. If you have one other handset it will ring. If you have extra handsets, press **Redial** or **Calls** to select the handset (1-5) you want, then press **OK**.
3. When the other handset answers you can announce the caller.
4. Press **Switch** to switch between the two callers if required. While speaking to the other handset, press  to transfer the call to the other handset.

## 3-Way conference call

You can hold a 3-way conference call between 2 internal callers and 1 external caller

1. During your call, press **Intercom**. Your external caller is put on hold.
2. If you have one other handset it will ring. If you have extra handsets press **Redial** or **Calls** to select the handset (1-5) you want, then press **OK**.
3. When the other handset answers you can announce the call. Press **Conf** to join all callers.

If the other handset does not answer, press **Back** to return to your original caller.

# Help

## Phone does not work

- Have you removed the pull tab and are the batteries installed correctly? See page 6.
- Check that the mains power is correctly connected.

## No dial tone

- Is the telephone cord of the base plugged into the phone socket?
- Check that the power is correctly connected.
- Only use the telephone cord supplied with the phone.

## Cannot dial out or receive calls

- Check that the power is correctly connected.
- Is the telephone line cord (provided with the product) plugged into the phone socket.
- The batteries may need recharging.
- Has there been a power cut? If so, place the handset back on the base for 10 seconds and try again. If it still does not work disconnect the batteries and mains power for 10 minutes, then reconnect and try again.

## You have a dial tone, but the phone will not dial out

- If you are connected to a switchboard, check whether you need to dial an access code.

## Handset does not ring

- The ringer volume may be switched off on the handset or the base, see page 24 and 26.
- Check that the power is correctly connected to the base.
- Make sure the handset is registered to the base, see page 40.

## No display

- The batteries may be flat, dead or incorrectly inserted.
- Recharge or replace the batteries (any replacement batteries must be rechargeable and of the same type supplied).

## 🔔 icon flashes

- Is the handset registered correctly to the base, see page 40.
- Check that the power is correctly connected.
- Check that the handset is within range of the base.
- The batteries are low, place the handset on the base/charger to recharge.

## You hear the busy tone when you press

- Another handset registered to your BT Diverse 7410 Plus base may be on the line.

## No Caller Display number/name displayed

- Have you subscribed to a Caller Display service from your network provider, see page 30.
- The caller may have withheld their number.
- An exact name/number match was not found in your phonebook.  
Check that you have stored the full STD dialling code.

## Cannot register a handset to a base

- You can register a total of 5 handsets to your BT Diverse 7410 Plus base and you can register your BT Diverse 7410 Plus handset to up to 4 bases. Check that you have not exceeded the limits.
- Check that you have entered the correct PIN number (default PIN 0000).
- Check that you are at least one metre away from other electrical equipment to avoid interference when registering.

## Base unit does not ring, but the lights are on

- Have you connected the telephone line to the telephone wall socket correctly?
- You must use the telephone line cord supplied with the product otherwise the phone may not work.
- Is the base ringer set to off?
- You may have a faulty line or socket. Try using another socket or line. Call BT on 151 if you still experience problems.

## You keep hearing a beep

- You have pressed the wrong button in a sequence. Check the prompts in the display or refer to instructions in this user guide.
- The New Call alert might be switched on. The default setting is Off but if you have switched this feature On, then your handset will beep when a missed call is received in your Calls list. See page 31 if you want to switch this feature Off.
- The beeping might be a new text message alert. Check if you have received a new text message and not viewed it yet, see page 37. This alert can be switched Off, see page 39.
- Your battery may be low. Please refer to the battery icons on page 9 and check against the icons on your handset display. If your battery is low, you will need to place the handset on the base to charge it.
- You may be hearing an error tone. If you press and hold a handset button that does not have a dual-function associated with it i.e. the BT button, then a long press will emit an error tone (providing the handset key tone is set to on) and will not open the BT menu. A long press and hold is only used for dual-function buttons i.e. a speed dial and keylock button etc, when the dual-function will respond and there will be no error tone.

## Buzzing noise on my phone or on other electrical equipment nearby

- Sometimes your BT Diverse 7410 Plus can interfere with other electrical equipment if it is placed too close. It is recommended that you place your BT Diverse 7410 Plus at least one metre away from electrical appliances or metal obstructions to avoid any risk of interference.
- Are you using your Diverse 7410 Plus on a Broadband line? If you are, then please ensure that it is connected via an ADSL microfilter otherwise it may cause problems with your phone and Broadband service. BT ADSL microfilters can be purchased from [www.shop.bt.com](http://www.shop.bt.com)

## Customer Helpline

If you are still experiencing difficulties please call the BT Diverse 7410 Plus Helpline on 0800 218 2182\* or visit [www.bt.com/producthelp](http://www.bt.com/producthelp).

## Possible problems with text messaging

### Text messages cannot be sent and screen displays Message not sent

- The base station power supply or telephone line cord might not be properly connected.
- Check that the base station power supply is plugged into the mains socket and switched on and that the telephone is plugged into the telephone wall socket.
- There might be a fault on the line. Check your telephone line is working properly.
- You might have deleted the server number in error. See page 39 for instructions on how to enter the number.

If you experience any problems, please call the Helpline on Freephone 0800 218 2182\* or visit [www.bt.com/producthelp](http://www.bt.com/producthelp)

## Cannot send text

- Check service centre number is correct including 1470P prefix (this is for BT lines. If you have another network provider please check the prefix number with them). In order to send and receive text messages you must not withhold your number. If you normally withhold your number the 1470 prefix presents your number for you.

## Cannot receive text

- You will not be able to receive text messages until you have first sent a message. The first message sent registers you with the text service.
- More than one text messaging product is plugged into the line. Either remove the other text (SMS) enabled products or see below "I want to use more than one text (SMS) enabled product on my telephone line" for alternative instructions.
- Check service centre number is correct.
- Ensure you have subscribed to a Caller Display service and that it is active. You can check this by noting if your phone displays your caller's number when you receive an incoming call.

## I want to use more than one text (SMS) enabled product on my telephone line

It is possible to connect more than one SMS product to the same telephone line and for both of them to send and receive Text messages, but you must amend the final digit of both the Send and Receive Service Centre telephone numbers first.

All BT text capable telephones are provided with the same send and receive telephone numbers, but with two or more text capable telephones connected to the same telephone line, delivery of text messages becomes unreliable causing the text to be delivered as a normal telephone call which when answered will be an electronic Text to Speech message.

To overcome this problem you must keep one of the products as it is with the default Send & Receive ending in a '9', but for the second and subsequent products you must change the final digit of the Service Centre numbers (from the default '9') to any unique number between 1 and 8 i.e for a second product change last digit from a '9' to a '1' by changing the Send number from 1470P17094009 to 1470P17094001 and the Receive number from 0800587529 to 0800587521. For the Send number, go into Text - Settings- Send centre 1- and amend the last digit and then press Save.... (For Rcv. Centre, go into Text - Settings - Rcv. Centre 1 and amend the last digit and then press Save).

Once changed, for the products that you have assigned new send and receive numbers, you need to send a new registration text to the Fixed Line Text Service platform to register the new identity (i.e. send a text to 00000 from the product that you changed the Send & Receive numbers). You can then send and receive text messages from more than one product.

## Text has previously been sent and received but you are now only receiving voice spoken text messages, from number 0845 6021111.

- This may be due to your line being de-registered at the text service centre. All you need to do is text `Reset` and send it to 00000. You will receive a confirmation message back. This assumes that your Caller Display service is active and working on your line. Messages sent to 00000 are free.

## Further help and advice for text queries on BT lines:

- BT Residential customers – call 151, choose option 2, when prompted by the Fault Management Service select option 2, enter your phone number on the handset and wait to speak to a customer adviser.
- BT Business Customers – call 152, choose option 2, when prompted by the Fault Management Service select option 2, enter your phone number on the handset and wait to speak to a customer adviser.
- For other telephone service providers please contact their customer services.

## General sales enquiries

- BT Residential lines – call 150. BT Business lines – call 152.
- For non BT line customers, call 0800 800 150 (residential) or 0800 800 152 (business).
- Additional handsets are available from the Helpdesk on 0800 218 2182\*.

## Billing enquiries

- Refer to the telephone number shown on your telephone bill.

## Other functions and services available from the text messaging service

By sending the following commands to the BT text self administration facility you can control functions and capabilities in your text phone and the way messages are handled.

1. Press `Menu`. `Text` is highlighted. Press `OK`.
2. `Write Message` is highlighted. Press `OK`.
3. Use the keypad to type in the following commands (depending upon what you want to do):

`*j #Δ #Δ` Opt out from receiving voice text messages.

`#Δ #Δ #Δ` Turns off the opt out option.







`*j 2ABC *j` Turns on permanent voice text message delivery to your phone.

All incoming text is delivered as voice text.

`#Δ 2ABC #Δ` Turns off permanent voice text message delivery.

4. Press `Options`. `Send` is highlighted, press `OK`.
5. Enter the number 00000 then press `Send`.

## If you are sending a message from a fixed line phone to another fixed line phone

   Forces a message you send to be delivered as a voice text even though the recipient may have a text enabled phone and usually receives written text. This command is inserted at the start of the message and applies only to that message, e.g.    'Hello I will be home late'.

## You keep hearing an error beep

- You have pressed the wrong button in a sequence. Check the prompts in the display or refer to instructions in this user guide.

## User Guide formats

This document is also available in other formats, such as Large print, Braille and Audio CD. If you would like a copy, please call 0800 218 2182\*.



# General information

## IMPORTANT

This equipment is not designed for making emergency telephone call when the power fails. Alternative arrangements should be made for access to emergency services.

This product is intended for connection to analogue public switched telephone networks and private switchboards in the United Kingdom.

## Replacing the handset batteries

After a time, you may find that the handset batteries are running out of charge more quickly. This is a standard sign of wear and the batteries will need replacing.

1. Slide open the battery compartment cover.
2. Take out the old batteries and replace with 2x AAA NiMH 600mAh **rechargeable** batteries.
3. Push the battery compartment cover back on until it clicks into place.

## Replacing the base plinth

If you ever remove the base plinth then follow this diagram re-attach it:

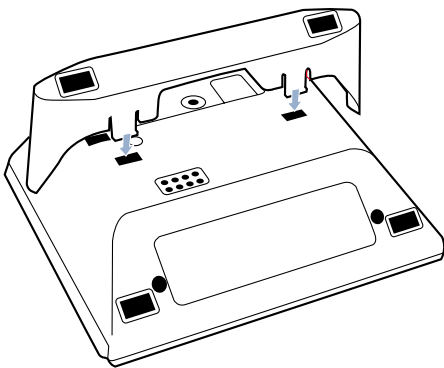

## WARNING

Do not immerse batteries in water or throw them into a fire, or dispose of them with ordinary domestic refuse.

BT accepts no responsibility for damage caused to your BT Diverse 7410 Plus by using any other types of batteries.

There is a risk of explosion if incorrect batteries are fitted.

## Safety information

- Only use the power supply suitable for the BT Diverse 7410 Plus range. Using an unauthorised power supply will invalidate your guarantee and may damage the telephone. The item code for the base mains power supply is 048610. If you have purchased a Diverse additional handset the item code for the charger mains power supply is 048610.
- Use only the approved rechargeable batteries supplied. Spare rechargeable batteries are available from the BT Diverse 7410 Plus Helpline on 0800 218 2182\*.
- Do not open the handset (except to replace the handset batteries) or the base. This could expose you to high voltages or other risks. Contact the Helpline on 0800 218 2182\* for all repairs.
- If the keylock is switched on, it is possible to make calls to emergency services numbers 999 and 112.
- Radio signal transmitted between the handset and base may cause interference to hearing aids.
- It is recommended that advice from a qualified expert be sought before using this product in the vicinity of emergency/intensive care medical equipment.
- It is recommended that if you have a pacemaker fitted you check with a medical expert before using this product.
- Your product may interfere with other electrical equipment, e.g. TV and radio sets, clock/alarms and computers if placed too close.
- It is recommended that you place your product at least one metre away from such appliances to minimise any risk of interference.
- Never dispose of batteries in a fire. There is a serious risk of explosion and/or the release of highly toxic chemicals.

## Cleaning

- Clean the handset and base (or charger) with a damp (not wet) cloth, or an anti-static wipe. Never use household polish as this will damage the product. Never use a dry cloth as this may cause a static shock.

## Environmental

- Do not expose to direct sunlight.
- The handset may become warm when the batteries are being charged or during prolonged periods of use. This is normal. However, we recommend that to avoid damage you do not place the product on antique/veneered wood.
- Do not stand your product on carpets or other surfaces which generate fibres, or place it in locations preventing the free flow of air over its surfaces.
- Do not submerge any part of your product in water and do not use it in damp or humid conditions, such as bathrooms.
- Do not expose your product to fire, explosive or other hazardous conditions.
- There is a slight chance your phone could be damaged by an electrical storm. We recommend that you unplug the power and telephone line cord during an electrical storm.

## Product disposal instructions

The symbol shown here and on the product means that the product is classed as Electrical or Electronic Equipment and should not be disposed with other household or commercial waste at the end of its working life.



The Waste of Electrical and Electronic Equipment (WEEE) Directive (2002/96/EC) has been put in place to recycle products using best available recovery and recycling techniques to minimize the impact on the environment, treat any hazardous substances and avoid the increasing landfill.

### Product disposal instructions for residential users

When you have no further use for it, please remove any batteries and dispose of them and the product as per your local authority's recycling processes. For more information please contact your local authority or the retailer where the product was purchased.

### Product disposal instructions for business users

Business users should contact their suppliers and check the terms and conditions of the purchase contract and ensure that this product is not mixed with other commercial waste for disposal.

## Guarantee

Your BT Diverse 7410 Plus is guaranteed for a period of 12 months from the date of purchase.

Subject to the terms listed below, the guarantee will provide for the repair of, or at BT's or its agent's discretion, the option to replace the BT Diverse 7410 Plus or any component thereof, (other than batteries), which is identified as faulty or below standard, or as a result of inferior workmanship or materials. Products over 28 days old from the date of purchase may be replaced with a refurbished or repaired product.

## The conditions of this guarantee are:

- The guarantee shall only apply to defects that occur within the 12 month guarantee period.
- Proof of purchase is provided.
- The equipment is returned to BT or its agent as instructed.
- This guarantee does not cover any faults or defects caused by accidents, misuse, fair wear and tear, neglect, tampering with the equipment, or any attempt at adjustment or repair other than through approved agents.
- This guarantee does not affect your statutory rights.

## Within the 12 month guarantee period:

If you experience difficulty using the product, prior to returning your product, please read the Help section beginning on page 43 or contact the BT Diverse Plus Helpdesk for assistance on 0800 218 2182\*. Additional answers to Frequently Asked Questions are available from [www.bt.com/producthelp](http://www.bt.com/producthelp)

In the unlikely event of a defect occurring, the helpdesk will issue a Fault Reference Authorisation (FRA) number and instructions for replacement or repair. Please note you will need the FRA number before returning the product. This does not affect your statutory rights.

## Outside of the 12 month guarantee period:

If your product needs repair after the guarantee period has ended, the repair must meet the approval requirements for connection to the telephone network. If you require technical assistance outside of the 12 month guarantee period, please call BT's approved technical support agent, Discount Communications Ltd on 0800 980 8999.

## Returning your phone

If the Helpline is unable to remedy your problem they will issue a Fault Reference Authorisation number and ask you to return the product to your original place of purchase. Where possible, pack the product in its original packaging. Please remember to include all parts, including the line cords, power supply units and the original batteries.

## For your records

Date of purchase:

Place of purchase:

Serial number:

For guarantee purposes proof of purchase is required so please keep your receipt.

\* Calls made from within the UK mainland network are free. Mobile and International call costs may vary.

## Technical information

### How many telephones can I have?

All items of telephone equipment have a Ringer Equivalence Number (REN), which is used to calculate the number of items which may be connected to any one telephone line. Your BT Diverse 7410 Plus has a REN of 1. A total REN of 4 is allowed. If the total REN of 4 is exceeded, the telephones may not ring. With different telephone types there is no guarantee of ringing, even when the REN is less than 4. Any additional handsets and chargers that you register have a REN of 0.

### R&TTE

This product is intended for use within the UK for connection to the public telephone network and compatible switchboards.

This equipment complies with the essential requirements for the Radio Equipment and Telecommunications Terminal Equipment Directive 1999/5/EC.

### Declaration of Conformance

Hereby, VTech declares that this BT Diverse 7410 Plus is in compliance with the essential requirements and other relevant provisions of Directive 1999/5/EC.

If you would like a copy of the Declaration of Conformance, please visit [www.bt.com/producthelp](http://www.bt.com/producthelp).

### Connecting to a switchboard

This product is intended for use within the UK for connection to the public telephone network and compatible switchboards, which support tone and pulse dialling and timed break or earth recall. If in doubt please consult your service provider.

### Inserting a pause

With some switchboards, after dialling the access code you may have to wait for a moment while the switchboard picks up an outside line so you will need to enter a pause in the dialing sequence.

Press and hold **0** to insert a pause (P) before entering the telephone number.

You may also need to enter a pause when storing international numbers or charge card numbers.

### Recall

You may need to use the recall function if you are connected to a switchboard/PBX (Private Branch Exchange), contact your PBX supplier for further information. The recall function is set to timed break recall by default and is also used for BT Calling Feature.



Working together, supporting energy saving products

BT & British Gas have joined forces to help our customers find new ways to save energy around the home, so we can all do our bit for the environment & save money too!

BT is a **sustainability leader**

{ To find out how we're  
making our products  
greener visit

[bt.com/betterworld/products](http://bt.com/betterworld/products) 

#### Offices worldwide

The services described in this publication are subject to availability and may be modified from time to time. Services and equipment are provided subject to British Telecommunications plc's respective standard conditions of contract. Nothing in this publication forms any part of any contract.

© British Telecommunications plc 2011.  
Registered Office: 81 Newgate Street, London EC1A 7AJ.  
Registered in England No. 1800000.  
Printed in China.

Designed and produced by The Art & Design Partnership Ltd.

BT Diverse 7410 Plus (04/11) Issue 1

